



# Workbenches and accessories

Workbenches from bott are robust and practical, ergonomic and flexible. A wide range of product variants gives you the freedom to configure solutions to your personal specification. Tailor-made workbenches are indispensable additions to any workshop.

An extensive line of accessories completes this product range.

|   |           |
|---|-----------|
| Workbench WEL                                       | 62 – 63   |
| Workbench WFT                                       | 64 – 65   |
| Accessories for workbench WEL & WFT                 | 66 – 67   |
| Workbench BMN                                       | 68 – 71   |
| Accessories for workbench BMN                       | 72 – 73   |
| Workbench WPB                                       | 74 – 75   |
| Workbench WB  | 76 – 79   |
| Group Workstations                                  | 80 – 81   |
| Accessories for workbench WB and Group Workstations | 82 – 83   |
| Workbench WL  | 84 – 85   |
| Accessories for workbench WL                        | 86 – 87   |
| Modular Workbenches KWB                             | 88 – 97   |
| Accessories for Modular Workbenches KWB             | 98 – 99   |
| Worktops  | 100 – 104 |
| Accessories & Parts for workbenches                 | 105 – 108 |
| Foldable Workbenches                                | 109       |
| Vices   | 110 – 111 |
| Seating   | 112 – 113 |



# Workbench WEL



Dimensions: Width 1500/2000 x Depth 700/900 x Height 830-850 mm

- Suitable for light assembly work
- Load capacity 200 kg
- Robust tubular steel framework
- Choose from 2 worktop finishes (Thickness 20 mm)
- Load capacity per drawer 75 kg
- Supplied flat packed for self assembly. We can offer a full assembly service, please contact us for details.
- Frame size: W 1434/1934 x D 694/894 x H 790 mm
- Drawer divider systems – see page 210-225



With CS series drawer cabinets – see page 12/13 for more details



| Description | Dimensions<br>W x D mm | Worktop   | Part ref.     | Price £ |
|-------------|------------------------|-----------|---------------|---------|
| WELM 1570   | 1500 x 700             | Multiplex | 110 42 301.16 | 187.00  |
| WELM 1590   | 1500 x 900             | Multiplex | 110 42 302.16 | 210.00  |
| WELM 2070   | 2000 x 700             | Multiplex | 110 42 303.16 | 227.00  |
| WELM 2090   | 2000 x 900             | Multiplex | 110 42 304.16 | 254.00  |
| WELL 1570   | 1500 x 700             | Linoleum  | 110 42 305.16 | 246.00  |
| WELL 1590   | 1500 x 900             | Linoleum  | 110 42 306.16 | 266.00  |
| WELL 2070   | 2000 x 700             | Linoleum  | 110 42 307.16 | 283.00  |
| WELL 2090   | 2000 x 900             | Linoleum  | 110 42 308.16 | 311.00  |



| Description          | Dimensions<br>W x D mm | Worktop   | Part ref.     | Price £ |
|----------------------|------------------------|-----------|---------------|---------|
| WELM 1570 + CS 225-1 | 1500 x 700             | Multiplex | 110 08 161.03 | 327.00  |
| WELM 1590 + CS 225-1 | 1500 x 900             | Multiplex | 110 08 167.03 | 350.00  |
| WELM 2070 + CS 225-1 | 2000 x 700             | Multiplex | 110 08 173.03 | 367.00  |
| WELM 2090 + CS 225-1 | 2000 x 900             | Multiplex | 110 08 179.03 | 394.00  |
| WELL 1570 + CS 225-1 | 1500 x 700             | Linoleum  | 110 08 185.03 | 386.00  |
| WELL 1590 + CS 225-1 | 1500 x 900             | Linoleum  | 110 08 191.03 | 406.00  |
| WELL 2070 + CS 225-1 | 2000 x 700             | Linoleum  | 110 08 197.03 | 423.00  |
| WELL 2090 + CS 225-1 | 2000 x 900             | Linoleum  | 110 08 203.03 | 451.00  |



| Description          | Dimensions<br>W x D mm | Worktop   | Part ref.     | Price £ |
|----------------------|------------------------|-----------|---------------|---------|
| WELM 1570 + CS 425-3 | 1500 x 700             | Multiplex | 110 08 162.03 | 432.00  |
| WELM 1590 + CS 425-3 | 1500 x 900             | Multiplex | 110 08 168.03 | 455.00  |
| WELM 2070 + CS 425-3 | 2000 x 700             | Multiplex | 110 08 174.03 | 472.00  |
| WELM 2090 + CS 425-3 | 2000 x 900             | Multiplex | 110 08 180.03 | 499.00  |
| WELL 1570 + CS 425-3 | 1500 x 700             | Linoleum  | 110 08 186.03 | 491.00  |
| WELL 1590 + CS 425-3 | 1500 x 900             | Linoleum  | 110 08 192.03 | 511.00  |
| WELL 2070 + CS 425-3 | 2000 x 700             | Linoleum  | 110 08 198.03 | 528.00  |
| WELL 2090 + CS 425-3 | 2000 x 900             | Linoleum  | 110 08 204.03 | 556.00  |



| Description          | Dimensions<br>W x D mm | Worktop   | Part ref.     | Price £ |
|----------------------|------------------------|-----------|---------------|---------|
| WELM 1570 + CS 650-1 | 1500 x 700             | Multiplex | 110 08 163.03 | 371.00  |
| WELM 1590 + CS 650-1 | 1500 x 900             | Multiplex | 110 08 169.03 | 394.00  |
| WELM 2070 + CS 650-1 | 2000 x 700             | Multiplex | 110 08 175.03 | 411.00  |
| WELM 2090 + CS 650-1 | 2000 x 900             | Multiplex | 110 08 181.03 | 438.00  |
| WELL 1570 + CS 650-1 | 1500 x 700             | Linoleum  | 110 08 187.03 | 430.00  |
| WELL 1590 + CS 650-1 | 1500 x 900             | Linoleum  | 110 08 193.03 | 450.00  |
| WELL 2070 + CS 650-1 | 2000 x 700             | Linoleum  | 110 08 199.03 | 467.00  |
| WELL 2090 + CS 650-1 | 2000 x 900             | Linoleum  | 110 08 205.03 | 495.00  |

## Standard paint finish

|          |                     |
|----------|---------------------|
| Housing: | RAL 7035 light grey |
| Fronts:  | RAL 5015 blue .03   |

## Alternative front colours (no extra charge)

|                         |                     |                     |                     |                     |
|-------------------------|---------------------|---------------------|---------------------|---------------------|
| RAL 7035 light grey     | RAL 7035 light grey | RAL 7035 light grey | RAL 7035 light grey | RAL 7035 light grey |
| RAL 7035 light grey .16 | RAL 7001 grey .01   | RAL 6011 green .02  | RAL 3001 red .04    | RAL 1023 yellow .12 |

(Please replace the order ref. suffix from .03 to that for your required colour)

# Workbench WEL

Dimensions: Width 1500/2000 x Depth 700/900 x Height 830-850 mm



| Description          | Dimensions<br>W x D mm | Worktop   | Part ref.     | Price £ |
|----------------------|------------------------|-----------|---------------|---------|
| WELM 1570 + CS 650-2 | 1500 x 700             | Multiplex | 110 08 164.03 | 413.00  |
| WELM 1590 + CS 650-2 | 1500 x 900             | Multiplex | 110 08 170.03 | 436.00  |
| WELM 2070 + CS 650-2 | 2000 x 700             | Multiplex | 110 08 176.03 | 453.00  |
| WELM 2090 + CS 650-2 | 2000 x 900             | Multiplex | 110 08 182.03 | 480.00  |
| WELL 1570 + CS 650-2 | 1500 x 700             | Linoleum  | 110 08 188.03 | 472.00  |
| WELL 1590 + CS 650-2 | 1500 x 900             | Linoleum  | 110 08 194.03 | 492.00  |
| WELL 2070 + CS 650-2 | 2000 x 700             | Linoleum  | 110 08 200.03 | 509.00  |
| WELL 2090 + CS 650-2 | 2000 x 900             | Linoleum  | 110 08 206.03 | 537.00  |



| Description          | Dimensions<br>W x D mm | Worktop   | Part ref.     | Price £ |
|----------------------|------------------------|-----------|---------------|---------|
| WELM 1570 + CS 650-3 | 1500 x 700             | Multiplex | 110 08 165.03 | 458.00  |
| WELM 1590 + CS 650-3 | 1500 x 900             | Multiplex | 110 08 171.03 | 481.00  |
| WELM 2070 + CS 650-3 | 2000 x 700             | Multiplex | 110 08 177.03 | 498.00  |
| WELM 2090 + CS 650-3 | 2000 x 900             | Multiplex | 110 08 183.03 | 525.00  |
| WELL 1570 + CS 650-3 | 1500 x 700             | Linoleum  | 110 08 189.03 | 517.00  |
| WELL 1590 + CS 650-3 | 1500 x 900             | Linoleum  | 110 08 195.03 | 537.00  |
| WELL 2070 + CS 650-3 | 2000 x 700             | Linoleum  | 110 08 201.03 | 554.00  |
| WELL 2090 + CS 650-3 | 2000 x 900             | Linoleum  | 110 08 207.03 | 582.00  |



| Description          | Dimensions<br>W x D mm | Worktop   | Part ref.     | Price £ |
|----------------------|------------------------|-----------|---------------|---------|
| WELM 1570 + CS 650-5 | 1500 x 700             | Multiplex | 110 08 166.03 | 556.00  |
| WELM 1590 + CS 650-5 | 1500 x 900             | Multiplex | 110 08 172.03 | 579.00  |
| WELM 2070 + CS 650-5 | 2000 x 700             | Multiplex | 110 08 178.03 | 596.00  |
| WELM 2090 + CS 650-5 | 2000 x 900             | Multiplex | 110 08 184.03 | 623.00  |
| WELL 1570 + CS 650-5 | 1500 x 700             | Linoleum  | 110 08 190.03 | 615.00  |
| WELL 1590 + CS 650-5 | 1500 x 900             | Linoleum  | 110 08 196.03 | 635.00  |
| WELL 2070 + CS 650-5 | 2000 x 700             | Linoleum  | 110 08 202.03 | 652.00  |
| WELL 2090 + CS 650-5 | 2000 x 900             | Linoleum  | 110 08 208.03 | 680.00  |

## Shelf for workbench WEL

Material: Chipboard core laminate faced



| Description | for workbench<br>with Width x Depth mm | Part ref.  | Price £ |
|-------------|--|------------|---------|
| Base shelf  | 1500 x 700                             | 110 42 040 | 97.00   |
| Base shelf  | 1500 x 900                             | 110 42 041 | 130.00  |
| Base shelf  | 2000 x 700                             | 110 42 042 | 111.00  |
| Base shelf  | 2000 x 900                             | 110 42 043 | 145.00  |

### Standard paint finish

|          |                     |
|----------|---------------------|
| Housing: | RAL 7035 light grey |
| Fronts:  | RAL 5015 blue .03   |

### Alternative front colours (no extra charge)

|                         |                     |                     |                     |                     |
|-------------------------|---------------------|---------------------|---------------------|---------------------|
| RAL 7035 light grey     | RAL 7035 light grey | RAL 7035 light grey | RAL 7035 light grey | RAL 7035 light grey |
| RAL 7035 light grey .16 | RAL 7001 grey .01   | RAL 6011 green .02  | RAL 3001 red .04    | RAL 1023 yellow .12 |

(Please replace the order ref. suffix from .03 to that for your required colour)

Drawer  
Cabinets

Workbenches

Workstation  
Systems APS

Mobile  
Equipment

Storage  
Cupboards

Combination Drawer  
& Shelving System

Drawer  
Dividers

Perfo® System

CNC System

Cases

# Workbench WFT

Dimensions: Width 1500/2000 x Depth 700/900 x Height 830-850 mm



- Suitable for light assembly work
- Load capacity 200 kg
- Tubular and sheet steel construction.
- Cantilever design for complete freedom of movement.
- Choose from 2 worktop finishes (Thickness 20 mm)
- Load capacity per drawer 75 kg
- Supplied flat packed for self assembly. We can offer a full assembly service, please contact us for details.
- Frame size: W 1420/1920 x D 694/894 x H 794 mm
- Drawer divider systems see page 210-225



With CS series drawer cabinets – see page 12/13 for more details



| Description | Dimensions<br>W x D mm | Worktop   | Part ref.     | Price £ |
|-------------|------------------------|-----------|---------------|---------|
| WFTM 1570   | 1500 x 700             | Multiplex | 110 43 001.16 | 285.55  |
| WFTM 1590   | 1500 x 900             | Multiplex | 110 43 002.16 | 310.35  |
| WFTM 2070   | 2000 x 700             | Multiplex | 110 43 003.16 | 315.05  |
| WFTM 2090   | 2000 x 900             | Multiplex | 110 43 004.16 | 344.63  |
| WFTL 1570   | 1500 x 700             | Linoleum  | 110 43 005.16 | 336.55  |
| WFTL 1590   | 1500 x 900             | Linoleum  | 110 43 006.16 | 376.39  |
| WFTL 2070   | 2000 x 700             | Linoleum  | 110 43 007.16 | 489.39  |
| WFTL 2090   | 2000 x 900             | Linoleum  | 110 43 008.16 | 420.02  |



| Description          | Dimensions<br>W x D mm | Worktop   | Part ref.     | Price £ |
|----------------------|------------------------|-----------|---------------|---------|
| WFTM 1570 + CS 225-1 | 1500 x 700             | Multiplex | 110 08 209.03 | 422.55  |
| WFTM 1590 + CS 225-1 | 1500 x 900             | Multiplex | 110 08 215.03 | 450.35  |
| WFTM 2070 + CS 225-1 | 2000 x 700             | Multiplex | 110 08 221.03 | 455.05  |
| WFTM 2090 + CS 225-1 | 2000 x 900             | Multiplex | 110 08 227.03 | 484.63  |
| WFTL 1570 + CS 225-1 | 1500 x 700             | Linoleum  | 110 08 233.03 | 476.56  |
| WFTL 1590 + CS 225-1 | 1500 x 900             | Linoleum  | 110 08 239.03 | 516.39  |
| WFTL 2070 + CS 225-1 | 2000 x 700             | Linoleum  | 110 08 245.03 | 629.39  |
| WFTL 2090 + CS 225-1 | 2000 x 900             | Linoleum  | 110 08 251.03 | 560.02  |



| Description          | Dimensions<br>W x D mm | Worktop   | Part ref.     | Price £ |
|----------------------|------------------------|-----------|---------------|---------|
| WFTM 1570 + CS 425-3 | 1500 x 700             | Multiplex | 110 08 210.03 | 527.55  |
| WFTM 1590 + CS 425-3 | 1500 x 900             | Multiplex | 110 08 216.03 | 555.35  |
| WFTM 2070 + CS 425-3 | 2000 x 700             | Multiplex | 110 08 222.03 | 560.05  |
| WFTM 2090 + CS 425-3 | 2000 x 900             | Multiplex | 110 08 228.03 | 589.63  |
| WFTL 1570 + CS 425-3 | 1500 x 700             | Linoleum  | 110 08 234.03 | 581.56  |
| WFTL 1590 + CS 425-3 | 1500 x 900             | Linoleum  | 110 08 240.03 | 621.39  |
| WFTL 2070 + CS 425-3 | 2000 x 700             | Linoleum  | 110 08 246.03 | 734.39  |
| WFTL 2090 + CS 425-3 | 2000 x 900             | Linoleum  | 110 08 252.03 | 665.02  |

## Standard paint finish

|          |                     |
|----------|---------------------|
| Housing: | RAL 7035 light grey |
| Fronts:  | RAL 5015 blue .03   |

## Alternative front colours (no extra charge)

|                         |                     |                     |                     |                     |
|-------------------------|---------------------|---------------------|---------------------|---------------------|
| RAL 7035 light grey     | RAL 7035 light grey | RAL 7035 light grey | RAL 7035 light grey | RAL 7035 light grey |
| RAL 7035 light grey .16 | RAL 7001 grey .01   | RAL 6011 green .02  | RAL 3001 red .04    | RAL 1023 yellow .12 |

(Please replace the order ref. suffix from .03 to that for your required colour)

# Workbench WFT

Dimensions: Width 1500/2000 x Depth 700/900 x Height 830-850 mm



| Description          | Dimensions<br>W x D mm | Worktop   | Part ref.     | Price £ |
|----------------------|------------------------|-----------|---------------|---------|
| WFTM 1570 + CS 650-1 | 1500 x 700             | Multiplex | 110 08 211.03 | 466.55  |
| WFTM 1590 + CS 650-1 | 1500 x 900             | Multiplex | 110 08 217.03 | 494.35  |
| WFTM 2070 + CS 650-1 | 2000 x 700             | Multiplex | 110 08 223.03 | 499.05  |
| WFTM 2090 + CS 650-1 | 2000 x 900             | Multiplex | 110 08 229.03 | 528.63  |
| WFTL 1570 + CS 650-1 | 1500 x 700             | Linoleum  | 110 08 235.03 | 520.56  |
| WFTL 1590 + CS 650-1 | 1500 x 900             | Linoleum  | 110 08 241.03 | 560.39  |
| WFTL 2070 + CS 650-1 | 2000 x 700             | Linoleum  | 110 08 247.03 | 673.39  |
| WFTL 2090 + CS 650-1 | 2000 x 900             | Linoleum  | 110 08 253.03 | 604.02  |



| Description          | Dimensions<br>W x D mm | Worktop   | Part ref.     | Price £ |
|----------------------|------------------------|-----------|---------------|---------|
| WFTM 1570 + CS 650-2 | 1500 x 700             | Multiplex | 110 08 212.03 | 508.55  |
| WFTM 1590 + CS 650-2 | 1500 x 900             | Multiplex | 110 08 218.03 | 536.35  |
| WFTM 2070 + CS 650-2 | 2000 x 700             | Multiplex | 110 08 224.03 | 541.05  |
| WFTM 2090 + CS 650-2 | 2000 x 900             | Multiplex | 110 08 230.03 | 570.63  |
| WFTL 1570 + CS 650-2 | 1500 x 700             | Linoleum  | 110 08 236.03 | 562.56  |
| WFTL 1590 + CS 650-2 | 1500 x 900             | Linoleum  | 110 08 242.03 | 602.39  |
| WFTL 2070 + CS 650-2 | 2000 x 700             | Linoleum  | 110 08 248.03 | 715.39  |
| WFTL 2090 + CS 650-2 | 2000 x 900             | Linoleum  | 110 08 254.03 | 646.02  |



| Description          | Dimensions<br>W x D mm | Worktop   | Part ref.     | Price £ |
|----------------------|------------------------|-----------|---------------|---------|
| WFTM 1570 + CS 650-3 | 1500 x 700             | Multiplex | 110 08 213.03 | 553.55  |
| WFTM 1590 + CS 650-3 | 1500 x 900             | Multiplex | 110 08 219.03 | 581.35  |
| WFTM 2070 + CS 650-3 | 2000 x 700             | Multiplex | 110 08 225.03 | 586.05  |
| WFTM 2090 + CS 650-3 | 2000 x 900             | Multiplex | 110 08 231.03 | 615.63  |
| WFTL 1570 + CS 650-3 | 1500 x 700             | Linoleum  | 110 08 237.03 | 607.56  |
| WFTL 1590 + CS 650-3 | 1500 x 900             | Linoleum  | 110 08 243.03 | 647.39  |
| WFTL 2070 + CS 650-3 | 2000 x 700             | Linoleum  | 110 08 249.03 | 760.39  |
| WFTL 2090 + CS 650-3 | 2000 x 900             | Linoleum  | 110 08 255.03 | 691.02  |



| Description          | Dimensions<br>W x D mm | Worktop   | Part ref.     | Price £ |
|----------------------|------------------------|-----------|---------------|---------|
| WFTM 1570 + CS 650-5 | 1500 x 700             | Multiplex | 110 08 214.03 | 651.55  |
| WFTM 1590 + CS 650-5 | 1500 x 900             | Multiplex | 110 08 220.03 | 679.35  |
| WFTM 2070 + CS 650-5 | 2000 x 700             | Multiplex | 110 08 226.03 | 684.05  |
| WFTM 2090 + CS 650-5 | 2000 x 900             | Multiplex | 110 08 232.03 | 713.63  |
| WFTL 1570 + CS 650-5 | 1500 x 700             | Linoleum  | 110 08 238.03 | 705.56  |
| WFTL 1590 + CS 650-5 | 1500 x 900             | Linoleum  | 110 08 244.03 | 745.39  |
| WFTL 2070 + CS 650-5 | 2000 x 700             | Linoleum  | 110 08 250.03 | 858.39  |
| WFTL 2090 + CS 650-5 | 2000 x 900             | Linoleum  | 110 08 256.03 | 789.02  |

## Standard paint finish

|          |                     |
|----------|---------------------|
| Housing: | RAL 7035 light grey |
| Fronts:  | RAL 5015 blue .03   |

## Alternative front colours (no extra charge)

|                         |                     |                     |                     |                     |
|-------------------------|---------------------|---------------------|---------------------|---------------------|
| RAL 7035 light grey     | RAL 7035 light grey | RAL 7035 light grey | RAL 7035 light grey | RAL 7035 light grey |
| RAL 7035 light grey .16 | RAL 7001 grey .01   | RAL 6011 green .02  | RAL 3001 red .04    | RAL 1023 yellow .12 |

(Please replace the order ref. suffix from .03 to that for your required colour)

Drawer  
Cabinets

Workbenches

Workstation  
Systems APS

Mobile  
Equipment

Storage  
Cupboards

Combination Drawer  
& Shelving System

Drawer  
Dividers

Perfo® System

CNC System

Cases

Drawer Cabinets

Workbenches

Workstation Systems APS

Mobile Equipment

Storage Cupboards

Combination Drawer & Shelving System

Drawer Dividers

Perfo® System

CNC System

Cases



B

B

A

G







D

E







F

C



- A**  Overhead light and frame (UK or EU version)
- B**  Support brackets (2 piece) max. height 1200 mm
- C**  Power duct (UK or EU version) incl. 4 outlets
- D**  Perfo® perforated panel
- E**  Perfo® louvred panel
- F**  Perfo® combination panels
- G**  Metal shelf

## Complete range consisting of:

|               | <b>A</b>  | <b>B</b>  | <b>C</b>  | <b>D</b>  | <b>E</b>  | <b>F</b>  | <b>G</b>   | Part ref.     | Price £ |
|---------------|---|---|---|---|---|---|--|---------------|---------|
| for workbench |  |  |  |  |  |  |  |               |         |
| Width mm      | *   | **  | *   |   |   |   |  |               |         |
| 1500          |   | •   |   | •   |   |   |  | 070 02 147.03 | 67.00   |
| 1500          |   | •   |   |   | •   |   |  | 070 02 148.03 | 67.00   |
| 1500          |   | •   |   |   |   | •   |  | 070 02 149.03 | 67.00   |
| 2000          |   | •   |   | •   |   |   |  | 070 02 150.03 | 82.00   |
| 2000          |   | •   |   |   | •   |   |  | 070 02 151.03 | 82.00   |
| 2000          |   | •   |   |   |   | •   |  | 070 02 152.03 | 82.00   |
| 1500          |   | •   | UK  | •   |   |   |  | 070 02 153.03 | 231.00  |
| 1500          |   | •   | UK  |   | •   |   |  | 070 02 154.03 | 231.00  |
| 1500          |   | •   | UK  |   |   | •   |  | 070 02 155.03 | 231.00  |
| 2000          |   | •   | UK  | •   |   |   |  | 070 02 156.03 | 253.00  |
| 2000          |   | •   | UK  |   | •   |   |  | 070 02 157.03 | 253.00  |
| 2000          |   | •   | UK  |   |   | •   |  | 070 02 158.03 | 253.00  |
| 1500          | EU / UK   | •   |   | •   |   |   | •  | 070 02 159.03 | 253.00  |
| 1500          | EU / UK   | •   |   |   | •   |   | •  | 070 02 160.03 | 253.00  |
| 1500          | EU / UK   | •   |   |   |   | •   | •  | 070 02 161.03 | 253.00  |
| 2000          | EU / UK   | •   |   | •   |   |   | •  | 070 02 162.03 | 281.00  |
| 2000          | EU / UK   | •   |   |   | •   |   | •  | 070 02 163.03 | 281.00  |
| 2000          | EU / UK   | •   |   |   |   | •   | •  | 070 02 164.03 | 281.00  |
| 1500          | EU / UK   | •   | UK  | •   |   |   | •  | 070 02 165.03 | 417.00  |
| 1500          | EU / UK   | •   | UK  |   | •   |   | •  | 070 02 166.03 | 417.00  |
| 1500          | EU / UK   | •   | UK  |   |   | •   | •  | 070 02 167.03 | 417.00  |
| 2000          | EU / UK   | •   | UK  | •   |   |   | •  | 070 02 168.03 | 452.00  |
| 2000          | EU / UK   | •   | UK  |   | •   |   | •  | 070 02 169.03 | 452.00  |
| 2000          | EU / UK   | •   | UK  |   |   | •   | •  | 070 02 170.03 | 452.00  |
| 1500          |   | •   | EU  | •   |   |   |  | 070 02 171.03 | 335.11  |
| 1500          |   | •   | EU  |   | •   |   |  | 070 02 172.03 | 335.11  |
| 1500          |   | •   | EU  |   |   | •   |  | 070 02 173.03 | 335.11  |
| 2000          |   | •   | EU  | •   |   |   |  | 070 02 174.03 | 356.75  |
| 2000          |   | •   | EU  |   | •   |   |  | 070 02 175.03 | 356.75  |
| 2000          |   | •   | EU  |   |   | •   |  | 070 02 176.03 | 356.75  |
| 1500          | EU / UK   | •   | EU  | •   |   |   | •  | 070 02 183.03 | 525.87  |
| 1500          | EU / UK   | •   | EU  |   | •   |   | •  | 070 02 184.03 | 525.87  |
| 1500          | EU / UK   | •   | EU  |   |   | •   | •  | 070 02 185.03 | 525.87  |
| 2000          | EU / UK   | •   | EU  | •   |   |   | •  | 070 02 186.03 | 597.61  |
| 2000          | EU / UK   | •   | EU  |   | •   |   | •  | 070 02 187.03 | 597.61  |
| 2000          | EU / UK   | •   | EU  |   |   | •   | •  | 070 02 188.03 | 597.61  |

\* For details of country-specific versions for other countries, please consult your local bott partner.  
 \*\* On-site electrical installation must be referred to a qualified electrician.  
 Individual components are available on request!



# Workbench BMN

Dimensions: Width 700 x Depth 700 x Height 830 mm



- Load capacity 500 kg
- Sheet steel construction
- Choose from 2 worktop finishes (Thickness 30 mm)
- Load capacity per drawer 75 kg
- Supplied flat packed for self assembly. We can offer a full assembly service, please contact us for details.
- Frame size: W 624 x D 600 x H 800 mm
- Drawer divider systems – see page 210-225



With CS series drawer cabinets – see page 12/13 for more details



| Description | Dimensions<br>W x D x H mm | Worktop   | Part ref.     | Price £ |
|-------------|----------------------------|-----------|---------------|---------|
| BMNM 0707   | 700 x 700 x 830            | Multiplex | 100 70 012.16 | 169.00  |
| BMNL 0707   | 700 x 700 x 830            | Linoleum  | 100 70 011.16 | 195.00  |



| Description          | Dimensions<br>W x D x H mm | Worktop   | Part ref.     | Price £ |
|----------------------|----------------------------|-----------|---------------|---------|
| BMNM 0707 + CS 225-1 | 700 x 700 x 830            | Multiplex | 110 44 170.03 | 309.27  |
| BMNL 0707 + CS 225-1 | 700 x 700 x 830            | Linoleum  | 110 44 160.03 | 335.27  |



| Description          | Dimensions<br>W x D x H mm | Worktop   | Part ref.     | Price £ |
|----------------------|----------------------------|-----------|---------------|---------|
| BMNM 0707 + CS 425-3 | 700 x 700 x 830            | Multiplex | 110 44 171.03 | 414.39  |
| BMNL 0707 + CS 425-3 | 700 x 700 x 830            | Linoleum  | 110 44 161.03 | 440.39  |

## Standard paint finish

|          |                     |
|----------|---------------------|
| Housing: | RAL 7035 light grey |
| Fronts:  | RAL 5015 blue .03   |

## Alternative front colours (no extra charge)

|                         |                     |                     |                     |                     |
|-------------------------|---------------------|---------------------|---------------------|---------------------|
| RAL 7035 light grey     | RAL 7035 light grey | RAL 7035 light grey | RAL 7035 light grey | RAL 7035 light grey |
| RAL 7035 light grey .16 | RAL 7001 grey .01   | RAL 6011 green .02  | RAL 3001 red .04    | RAL 1023 yellow .12 |

(Please replace the order ref. suffix from .03 to that for your required colour)

# Workbench BMN

Dimensions: Width 700 x Depth 700 x Height 830 mm



| Description          | Dimensions<br>W x D x H mm | Worktop   | Part ref.     | Price £ |
|----------------------|----------------------------|-----------|---------------|---------|
| BMNM 0707 + CS 650-1 | 700 x 700 x 830            | Multiplex | 110 44 172.03 | 353.32  |
| BMNL 0707 + CS 650-1 | 700 x 700 x 830            | Linoleum  | 110 44 162.03 | 379.32  |



| Description          | Dimensions<br>W x D x H mm | Worktop   | Part ref.     | Price £ |
|----------------------|----------------------------|-----------|---------------|---------|
| BMNM 0707 + CS 650-2 | 700 x 700 x 830            | Multiplex | 110 44 173.03 | 395.08  |
| BMNL 0707 + CS 650-2 | 700 x 700 x 830            | Linoleum  | 110 44 163.03 | 421.08  |



| Description          | Dimensions<br>W x D x H mm | Worktop   | Part ref.     | Price £ |
|----------------------|----------------------------|-----------|---------------|---------|
| BMNM 0707 + CS 650-3 | 700 x 700 x 830            | Multiplex | 110 44 174.03 | 439.63  |
| BMNL 0707 + CS 650-3 | 700 x 700 x 830            | Linoleum  | 110 44 164.03 | 465.63  |



| Description          | Dimensions<br>W x D x H mm | Worktop   | Part ref.     | Price £ |
|----------------------|----------------------------|-----------|---------------|---------|
| BMNM 0707 + CS 650-5 | 700 x 700 x 830            | Multiplex | 110 44 175.03 | 537.89  |
| BMNL 0707 + CS 650-5 | 700 x 700 x 830            | Linoleum  | 110 44 165.03 | 563.89  |

## Standard paint finish

|          |                     |
|----------|---------------------|
| Housing: | RAL 7035 light grey |
| Fronts:  | RAL 5015 blue .03   |

## Alternative front colours (no extra charge)

|                         |                     |                     |                     |                     |
|-------------------------|---------------------|---------------------|---------------------|---------------------|
| RAL 7035 light grey     | RAL 7035 light grey | RAL 7035 light grey | RAL 7035 light grey | RAL 7035 light grey |
| RAL 7035 light grey .16 | RAL 7001 grey .01   | RAL 6011 green .02  | RAL 3001 red .04    | RAL 1023 yellow .12 |

(Please replace the order ref. suffix from .03 to that for your required colour)

Drawer  
Cabinets

Workbenches

Workstation  
Systems APS

Mobile  
Equipment

Storage  
Cupboards

Combination Drawer  
& Shelving System

Drawer  
Dividers

Perfo® System

CNC System

Cases

# Workbench BMN

Dimensions: Width 1500/2000 x Depth 700/900 x Height 830 mm



- Load capacity 500 kg
- Sheet steel construction
- Modular system with a wide range of accessories
- Choose from 2 worktop finishes (Thickness 30 mm)
- Load capacity per drawer 75 kg
- Optional Leg extension set (see page 72) allows height adjustment from 830 to 980 mm
- Supplied flat packed for self assembly. We can offer a full assembly service, please contact us for details.
- Frame size: W 1440/1940 x D 600/800 x H 800 mm
- Drawer divider systems see page 210-225



With CS series drawer cabinets – see page 12/13 for more details



| Description | Dimensions<br>W x D mm | Worktop   | Part ref.     | Price £ |
|-------------|------------------------|-----------|---------------|---------|
| BMNM 1570   | 1500 x 700             | Multiplex | 110 44 301.16 | 178.87  |
| BMNM 1590   | 1500 x 900             | Multiplex | 110 44 302.16 | 219.83  |
| BMNM 2070   | 2000 x 700             | Multiplex | 110 44 303.16 | 223.13  |
| BMNM 2090   | 2000 x 900             | Multiplex | 110 44 304.16 | 272.93  |
| BMNL 1570   | 1500 x 700             | Linoleum  | 110 44 305.16 | 212.18  |
| BMNL 1590   | 1500 x 900             | Linoleum  | 110 44 306.16 | 244.57  |
| BMNL 2070   | 2000 x 700             | Linoleum  | 110 44 307.16 | 249.29  |
| BMNL 2090   | 2000 x 900             | Linoleum  | 110 44 308.16 | 321.99  |



| Description          | Dimensions<br>W x D mm | Worktop   | Part ref.     | Price £ |
|----------------------|------------------------|-----------|---------------|---------|
| BMNM 1570 + CS 225-1 | 1500 x 700             | Multiplex | 110 44 309.03 | 318.87  |
| BMNM 1590 + CS 225-1 | 1500 x 900             | Multiplex | 110 44 310.03 | 359.83  |
| BMNM 2070 + CS 225-1 | 2000 x 700             | Multiplex | 110 44 311.03 | 363.13  |
| BMNM 2090 + CS 225-1 | 2000 x 900             | Multiplex | 110 44 312.03 | 412.93  |
| BMNL 1570 + CS 225-1 | 1500 x 700             | Linoleum  | 110 44 313.03 | 352.18  |
| BMNL 1590 + CS 225-1 | 1500 x 900             | Linoleum  | 110 44 314.03 | 384.57  |
| BMNL 2070 + CS 225-1 | 2000 x 700             | Linoleum  | 110 44 315.03 | 389.29  |
| BMNL 2090 + CS 225-1 | 2000 x 900             | Linoleum  | 110 44 316.03 | 461.99  |



| Description          | Dimensions<br>W x D mm | Worktop   | Part ref.     | Price £ |
|----------------------|------------------------|-----------|---------------|---------|
| BMNM 1570 + CS 425-3 | 1500 x 700             | Multiplex | 110 44 317.03 | 423.87  |
| BMNM 1590 + CS 425-3 | 1500 x 900             | Multiplex | 110 44 318.03 | 464.83  |
| BMNM 2070 + CS 425-3 | 2000 x 700             | Multiplex | 110 44 319.03 | 468.13  |
| BMNM 2090 + CS 425-3 | 2000 x 900             | Multiplex | 110 44 320.03 | 517.93  |
| BMNL 1570 + CS 425-3 | 1500 x 700             | Linoleum  | 110 44 321.03 | 457.18  |
| BMNL 1590 + CS 425-3 | 1500 x 900             | Linoleum  | 110 44 322.03 | 489.57  |
| BMNL 2070 + CS 425-3 | 2000 x 700             | Linoleum  | 110 44 323.03 | 494.29  |
| BMNL 2090 + CS 425-3 | 2000 x 900             | Linoleum  | 110 44 324.03 | 566.99  |

## Standard paint finish

|          |                     |
|----------|---------------------|
| Housing: | RAL 7035 light grey |
| Fronts:  | RAL 5015 blue .03   |

## Alternative front colours (no extra charge)

|                         |                     |                     |                     |                     |
|-------------------------|---------------------|---------------------|---------------------|---------------------|
| RAL 7035 light grey     | RAL 7035 light grey | RAL 7035 light grey | RAL 7035 light grey | RAL 7035 light grey |
| RAL 7035 light grey .16 | RAL 7001 grey .01   | RAL 6011 green .02  | RAL 3001 red .04    | RAL 1023 yellow .12 |

(Please replace the order ref. suffix from .03 to that for your required colour)

# Workbench BMN

Dimensions: Width 1500/2000 x Depth 700/900 x Height 830 mm



| Description          | Dimensions<br>W x D mm | Worktop   | Part ref.     | Price £ |
|----------------------|------------------------|-----------|---------------|---------|
| BMNM 1570 + CS 650-1 | 1500 x 700             | Multiplex | 110 44 325.03 | 362.87  |
| BMNM 1590 + CS 650-1 | 1500 x 900             | Multiplex | 110 44 326.03 | 403.83  |
| BMNM 2070 + CS 650-1 | 2000 x 700             | Multiplex | 110 44 327.03 | 407.13  |
| BMNM 2090 + CS 650-1 | 2000 x 900             | Multiplex | 110 44 328.03 | 456.93  |
| BMNL 1570 + CS 650-1 | 1500 x 700             | Linoleum  | 110 44 329.03 | 396.18  |
| BMNL 1590 + CS 650-1 | 1500 x 900             | Linoleum  | 110 44 330.03 | 428.57  |
| BMNL 2070 + CS 650-1 | 2000 x 700             | Linoleum  | 110 44 331.03 | 433.29  |
| BMNL 2090 + CS 650-1 | 2000 x 900             | Linoleum  | 110 44 332.03 | 505.99  |



| Description          | Dimensions<br>W x D mm | Worktop   | Part ref.     | Price £ |
|----------------------|------------------------|-----------|---------------|---------|
| BMNM 1570 + CS 650-2 | 1500 x 700             | Multiplex | 110 44 333.03 | 404.87  |
| BMNM 1590 + CS 650-2 | 1500 x 900             | Multiplex | 110 44 334.03 | 445.83  |
| BMNM 2070 + CS 650-2 | 2000 x 700             | Multiplex | 110 44 335.03 | 449.13  |
| BMNM 2090 + CS 650-2 | 2000 x 900             | Multiplex | 110 44 336.03 | 498.93  |
| BMNL 1570 + CS 650-2 | 1500 x 700             | Linoleum  | 110 44 337.03 | 438.18  |
| BMNL 1590 + CS 650-2 | 1500 x 900             | Linoleum  | 110 44 338.03 | 470.57  |
| BMNL 2070 + CS 650-2 | 2000 x 700             | Linoleum  | 110 44 339.03 | 475.29  |
| BMNL 2090 + CS 650-2 | 2000 x 900             | Linoleum  | 110 44 340.03 | 547.99  |



| Description          | Dimensions<br>W x D mm | Worktop   | Part ref.     | Price £ |
|----------------------|------------------------|-----------|---------------|---------|
| BMNM 1570 + CS 650-3 | 1500 x 700             | Multiplex | 110 44 341.03 | 449.87  |
| BMNM 1590 + CS 650-3 | 1500 x 900             | Multiplex | 110 44 342.03 | 490.83  |
| BMNM 2070 + CS 650-3 | 2000 x 700             | Multiplex | 110 44 343.03 | 494.13  |
| BMNM 2090 + CS 650-3 | 2000 x 900             | Multiplex | 110 44 344.03 | 543.93  |
| BMNL 1570 + CS 650-3 | 1500 x 700             | Linoleum  | 110 44 345.03 | 483.18  |
| BMNL 1590 + CS 650-3 | 1500 x 900             | Linoleum  | 110 44 346.03 | 515.57  |
| BMNL 2070 + CS 650-3 | 2000 x 700             | Linoleum  | 110 44 347.03 | 520.29  |
| BMNL 2090 + CS 650-3 | 2000 x 900             | Linoleum  | 110 44 348.03 | 592.99  |

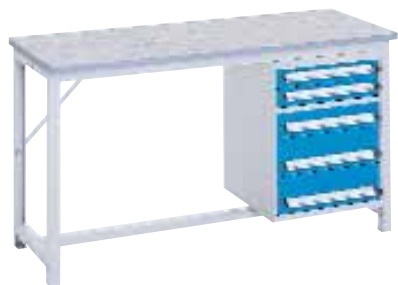

| Description          | Dimensions<br>W x D mm | Worktop   | Part ref.     | Price £ |
|----------------------|------------------------|-----------|---------------|---------|
| BMNM 1570 + CS 650-5 | 1500 x 700             | Multiplex | 110 44 349.03 | 547.87  |
| BMNM 1590 + CS 650-5 | 1500 x 900             | Multiplex | 110 44 350.03 | 588.83  |
| BMNM 2070 + CS 650-5 | 2000 x 700             | Multiplex | 110 44 351.03 | 592.13  |
| BMNM 2090 + CS 650-5 | 2000 x 900             | Multiplex | 110 44 352.03 | 641.93  |
| BMNL 1570 + CS 650-5 | 1500 x 700             | Linoleum  | 110 44 353.03 | 581.18  |
| BMNL 1590 + CS 650-5 | 1500 x 900             | Linoleum  | 110 44 354.03 | 613.57  |
| BMNL 2070 + CS 650-5 | 2000 x 700             | Linoleum  | 110 44 355.03 | 618.29  |
| BMNL 2090 + CS 650-5 | 2000 x 900             | Linoleum  | 110 44 356.03 | 690.99  |

## Standard paint finish

|          |                     |
|----------|---------------------|
| Housing: | RAL 7035 light grey |
| Fronts:  | RAL 5015 blue .03   |

## Alternative front colours (no extra charge)

|                         |                     |                     |                     |                     |
|-------------------------|---------------------|---------------------|---------------------|---------------------|
| RAL 7035 light grey     | RAL 7035 light grey | RAL 7035 light grey | RAL 7035 light grey | RAL 7035 light grey |
| RAL 7035 light grey .16 | RAL 7001 grey .01   | RAL 6011 green .02  | RAL 3001 red .04    | RAL 1023 yellow .12 |

(Please replace the order ref. suffix from .03 to that for your required colour)

Drawer  
Cabinets

Workbenches

Workstation  
Systems APS

Mobile  
Equipment

Storage  
Cupboards

Combination Drawer  
& Shelving System

Drawer  
Dividers

Perfo® System

CNC System

Cases

# Accessories for workbench BMN

1500 and 2000 mm width only



Drawer Cabinets

Workbenches

Workstation Systems APS

Mobile Equipment

Storage Cupboards

Combination Drawer & Shelving System

Drawer Dividers

Perfo® System

CNC System



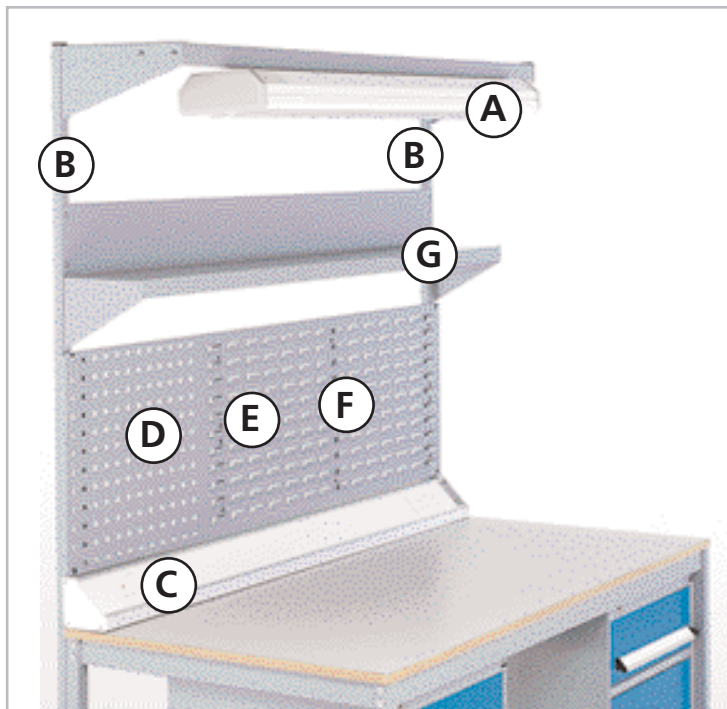



Cases









| Fig. | Description                      | for workbench with dimensions | Part ref.     | Price £ |
|------|----------------------------------|-------------------------------|---------------|---------|
| 1    | End modesty panel (pair)         | W 1500/2000 x D 700 mm        | 122 05 029.16 | 42.00   |
|      | End modesty panel (pair)         | W 1500/2000 x D 900 mm        | 122 05 030.16 | 50.00   |
| 2    | Rear modesty panel (pair)        | W 1500 mm                     | 122 05 026.16 | 37.00   |
|      | Rear modesty panel (pair)        | W 2000 mm                     | 122 05 027.16 | 44.00   |
| 3    | Base shelf (365 mm deep)         | W 1500 mm                     | 121 01 347.16 | 34.00   |
|      | Base shelf (365 mm deep)         | W 2000 mm                     | 121 01 348.16 | 45.00   |
| 4    | Full shelf (730 mm deep)*        | W 1500 mm                     | 121 01 349.16 | 65.00   |
|      | Full shelf (730 mm deep)*        | W 2000 mm                     | 121 01 350.16 | 86.00   |
|      | *available only for depth 900 mm |                               |               |         |
| 5    | Height extension set             | Height 150 mm                 | 114 01 102.16 | 17.00   |

# Accessories for workbench BMN



- A**  Overhead light and frame (UK or EU version)
- B**  Support brackets (2 piece) max. height 1200 mm
- C**  Power duct (UK or EU version) incl. 4 outlets
- D**  Perfo® perforated panel
- E**  Perfo® louvred panel
- F**  Perfo® combination panels
- G**  Metal shelf

## Complete range consisting of:

|                           | <b>A</b>  | <b>B</b>  | <b>C</b>  | <b>D</b>  | <b>E</b>  | <b>F</b>  | <b>G</b>   | Part ref.     | Price £ |
|---------------------------|---|---|---|---|---|---|--|---------------|---------|
| for workbench<br>Width mm |  * |  |  * |  |  |  |  |               |         |
| 1500                      |   | •   |   | •   |   |   |  | 070 02 147.03 | 67.00   |
| 1500                      |   | •   |   |   | •   |   |  | 070 02 148.03 | 67.00   |
| 1500                      |   | •   |   |   |   | •   |  | 070 02 149.03 | 67.00   |
| 2000                      |   | •   |   | •   |   |   |  | 070 02 150.03 | 82.00   |
| 2000                      |   | •   |   |   | •   |   |  | 070 02 151.03 | 82.00   |
| 2000                      |   | •   |   |   |   | •   |  | 070 02 152.03 | 82.00   |
| 1500                      |   | •   | UK  | •   |   |   |  | 070 02 153.03 | 231.00  |
| 1500                      |   | •   | UK  |   | •   |   |  | 070 02 154.03 | 231.00  |
| 1500                      |   | •   | UK  |   |   | •   |  | 070 02 155.03 | 231.00  |
| 2000                      |   | •   | UK  | •   |   |   |  | 070 02 156.03 | 253.00  |
| 2000                      |   | •   | UK  |   | •   |   |  | 070 02 157.03 | 253.00  |
| 2000                      |   | •   | UK  |   |   | •   |  | 070 02 158.03 | 253.00  |
| 1500                      | EU / UK   | •   |   | •   |   |   | •  | 070 02 159.03 | 253.00  |
| 1500                      | EU / UK   | •   |   |   | •   |   | •  | 070 02 160.03 | 253.00  |
| 1500                      | EU / UK   | •   |   |   |   | •   | •  | 070 02 161.03 | 253.00  |
| 2000                      | EU / UK   | •   |   | •   |   |   | •  | 070 02 162.03 | 281.00  |
| 2000                      | EU / UK   | •   |   |   | •   |   | •  | 070 02 163.03 | 281.00  |
| 2000                      | EU / UK   | •   |   |   |   | •   | •  | 070 02 164.03 | 281.00  |
| 1500                      | EU / UK   | •   | UK  | •   |   |   | •  | 070 02 165.03 | 417.00  |
| 1500                      | EU / UK   | •   | UK  |   | •   |   | •  | 070 02 166.03 | 417.00  |
| 1500                      | EU / UK   | •   | UK  |   |   | •   | •  | 070 02 167.03 | 417.00  |
| 2000                      | EU / UK   | •   | UK  | •   |   |   | •  | 070 02 168.03 | 452.00  |
| 2000                      | EU / UK   | •   | UK  |   | •   |   | •  | 070 02 169.03 | 452.00  |
| 2000                      | EU / UK   | •   | UK  |   |   | •   | •  | 070 02 170.03 | 452.00  |
| 1500                      |   | •   | EU  | •   |   |   |  | 070 02 171.03 | 335.11  |
| 1500                      |   | •   | EU  |   | •   |   |  | 070 02 172.03 | 335.11  |
| 1500                      |   | •   | EU  |   |   | •   |  | 070 02 173.03 | 335.11  |
| 2000                      |   | •   | EU  | •   |   |   |  | 070 02 174.03 | 356.75  |
| 2000                      |   | •   | EU  |   | •   |   |  | 070 02 175.03 | 356.75  |
| 2000                      |   | •   | EU  |   |   | •   |  | 070 02 176.03 | 356.75  |
| 1500                      | EU / UK   | •   | EU  | •   |   |   | •  | 070 02 183.03 | 525.87  |
| 1500                      | EU / UK   | •   | EU  |   | •   |   | •  | 070 02 184.03 | 525.87  |
| 1500                      | EU / UK   | •   | EU  |   |   | •   | •  | 070 02 185.03 | 525.87  |
| 2000                      | EU / UK   | •   | EU  | •   |   |   | •  | 070 02 186.03 | 597.61  |
| 2000                      | EU / UK   | •   | EU  |   | •   |   | •  | 070 02 187.03 | 597.61  |
| 2000                      | EU / UK   | •   | EU  |   |   | •   | •  | 070 02 188.03 | 597.61  |

\* For details of country-specific versions for other countries, please consult your local bott partner.  
 \*\* On-site electrical installation must be referred to a qualified electrician.  
 Individual components are available on request!

Drawer Cabinets  
 Workbenches  
 Workstation Systems APS  
 Mobile Equipment  
 Storage Cupboards  
 Combination Drawer & Shelving System  
 Drawer Dividers  
 Perfo® System  
 CNC System  
 Cases

# Workbench WPB

Dimensions: Width 1500/2000 x Depth 700/900 x Height 840 mm



- Perfect for engineering work
- Load capacity 300-400 kg depending on bench length
- Robust steel framework
- Choose from 2 worktop finishes (Thickness 40 mm)
- Load capacity per drawer 75 kg
- Supplied flat packed for self assembly. We can offer a full assembly service, please contact us for details.
- Frame size: W 1465/1965 x D 600/800 x H 800 mm
- Drawer divider systems see page 210-225



With CS series drawer cabinets – see page 12/13 for more details



| Description | Dimensions<br>W x D mm | Worktop   | Part ref.     | Price £ |
|-------------|------------------------|-----------|---------------|---------|
| WPBM 1570   | 1500 x 700             | Multiplex | 110 02 076.16 | 192.95  |
| WPBM 1590   | 1500 x 900             | Multiplex | 110 02 078.16 | 224.17  |
| WPBM 2070   | 2000 x 700             | Multiplex | 110 02 080.16 | 243.10  |
| WPBM 2090   | 2000 x 900             | Multiplex | 110 02 082.16 | 265.18  |
| WPBL 1570   | 1500 x 700             | Linoleum  | 110 02 075.16 | 234.96  |
| WPBL 1590   | 1500 x 900             | Linoleum  | 110 02 077.16 | 283.17  |
| WPBL 2070   | 2000 x 700             | Linoleum  | 110 02 079.16 | 301.08  |
| WPBL 2090   | 2000 x 900             | Linoleum  | 110 02 081.16 | 357.54  |



| Description          | Dimensions<br>W x D mm | Worktop   | Part ref.     | Price £ |
|----------------------|------------------------|-----------|---------------|---------|
| WPBM 1570 + CS 225-1 | 1500 x 700             | Multiplex | 110 08 140.03 | 332.95  |
| WPBM 1590 + CS 225-1 | 1500 x 900             | Multiplex | 110 08 146.03 | 364.17  |
| WPBM 2070 + CS 225-1 | 2000 x 700             | Multiplex | 110 08 152.03 | 383.10  |
| WPBM 2090 + CS 225-1 | 2000 x 900             | Multiplex | 110 08 158.03 | 405.18  |
| WPBL 1570 + CS 225-1 | 1500 x 700             | Linoleum  | 110 08 137.03 | 374.96  |
| WPBL 1590 + CS 225-1 | 1500 x 900             | Linoleum  | 110 08 143.03 | 423.17  |
| WPBL 2070 + CS 225-1 | 2000 x 700             | Linoleum  | 110 08 149.03 | 441.08  |
| WPBL 2090 + CS 225-1 | 2000 x 900             | Linoleum  | 110 08 155.03 | 497.54  |

## Standard paint finish

|          |                     |
|----------|---------------------|
| Housing: | RAL 7035 light grey |
| Fronts:  | RAL 5015 blue .03   |

## Alternative front colours (no extra charge)

|                         |                     |                     |                     |                     |
|-------------------------|---------------------|---------------------|---------------------|---------------------|
| RAL 7035 light grey     | RAL 7035 light grey | RAL 7035 light grey | RAL 7035 light grey | RAL 7035 light grey |
| RAL 7035 light grey .16 | RAL 7001 grey .01   | RAL 6011 green .02  | RAL 3001 red .04    | RAL 1023 yellow .12 |

(Please replace the order ref. suffix from .03 to that for your required colour)

# Workbench WPB

Dimensions: Width 1500/2000 x Depth 700/900 x Height 840 mm



| Description          | Dimensions<br>W x D mm | Worktop   | Part ref.     | Price £ |
|----------------------|------------------------|-----------|---------------|---------|
| WPBM 1570 + CS 800-4 | 1500 x 700             | Multiplex | 110 08 141.03 | 546.95  |
| WPBM 1590 + CS 800-4 | 1500 x 900             | Multiplex | 110 08 147.03 | 578.17  |
| WPBM 2070 + CS 800-4 | 2000 x 700             | Multiplex | 110 08 153.03 | 597.10  |
| WPBM 2090 + CS 800-4 | 2000 x 900             | Multiplex | 110 08 159.03 | 619.18  |
| WPBL 1570 + CS 800-4 | 1500 x 700             | Linoleum  | 110 08 138.03 | 588.96  |
| WPBL 1590 + CS 800-4 | 1500 x 900             | Linoleum  | 110 08 144.03 | 637.17  |
| WPBL 2070 + CS 800-4 | 2000 x 700             | Linoleum  | 110 08 150.03 | 655.08  |
| WPBL 2090 + CS 800-4 | 2000 x 900             | Linoleum  | 110 08 156.03 | 711.54  |



| Description          | Dimensions<br>W x D mm | Worktop   | Part ref.     | Price £ |
|----------------------|------------------------|-----------|---------------|---------|
| WPBM 1570 + CS 800-6 | 1500 x 700             | Multiplex | 110 08 142.03 | 646.95  |
| WPBM 1590 + CS 800-6 | 1500 x 900             | Multiplex | 110 08 148.03 | 678.17  |
| WPBM 2070 + CS 800-6 | 2000 x 700             | Multiplex | 110 08 154.03 | 697.10  |
| WPBM 2090 + CS 800-6 | 2000 x 900             | Multiplex | 110 08 160.03 | 719.18  |
| WPBL 1570 + CS 800-6 | 1500 x 700             | Linoleum  | 110 08 139.03 | 688.96  |
| WPBL 1590 + CS 800-6 | 1500 x 900             | Linoleum  | 110 08 145.03 | 737.17  |
| WPBL 2070 + CS 800-6 | 2000 x 700             | Linoleum  | 110 08 151.03 | 755.08  |
| WPBL 2090 + CS 800-6 | 2000 x 900             | Linoleum  | 110 08 157.03 | 811.54  |

## Standard paint finish

|          |                     |
|----------|---------------------|
| Housing: | RAL 7035 light grey |
| Fronts:  | RAL 5015 blue .03   |

## Alternative front colours (no extra charge)

|                         |                     |                     |                     |                     |
|-------------------------|---------------------|---------------------|---------------------|---------------------|
| RAL 7035 light grey     | RAL 7035 light grey | RAL 7035 light grey | RAL 7035 light grey | RAL 7035 light grey |
| RAL 7035 light grey .16 | RAL 7001 grey .01   | RAL 6011 green .02  | RAL 3001 red .04    | RAL 1023 yellow .12 |

(Please replace the order ref. suffix from .03 to that for your required colour)

Drawer  
Cabinets

Workbenches

Workstation  
Systems APS

Mobile  
Equipment

Storage  
Cupboards

Combination Drawer  
& Shelving System

Drawer  
Dividers

Perfo® System

CNC System

Cases



# Workbench WB



Dimensions: Width 1500/2000 x Depth 700 x Height 840 mm

- Suitable for heavy assembly work
- Load capacity 150-1500 kg depending on worktop version
- Choose from 2 worktop finishes (Thickness 40 mm)
- Load capacity per drawer 100 kg
- Drawer divider systems see page 210-225
- Supplied flat packed for self assembly. We can offer a full assembly service, please contact us for details.



With CK and CM series drawer cabinets – see page 24/25 and 30/31 for more details

| Description     | Dimensions<br>W x D x H mm | Worktop   | Part ref.     | Price £ |
|-----------------|----------------------------|-----------|---------------|---------|
| WBM 40 1570-0.1 | 1500 x 700 x 840           | Multiplex | 110 01 052.16 | 201.74  |
| WBM 40 2070-0.1 | 2000 x 700 x 840           | Multiplex | 110 01 054.16 | 239.16  |
| WBL 40 1570-0.1 | 1500 x 700 x 840           | Linoleum  | 110 01 064.16 | 265.15  |
| WBL 40 2070-0.1 | 2000 x 700 x 840           | Linoleum  | 110 01 065.16 | 306.37  |



Shelf

| Description     | Dimensions<br>W x D x H mm | Worktop   | Part ref.     | Price £ |
|-----------------|----------------------------|-----------|---------------|---------|
| WBM 40 1570-0.5 | 1500 x 700 x 840           | Multiplex | 110 03 050.16 | 243.04  |
| WBM 40 2070-0.5 | 2000 x 700 x 840           | Multiplex | 110 03 052.16 | 313.11  |
| WBL 40 1570-0.5 | 1500 x 700 x 840           | Linoleum  | 110 03 080.16 | 319.51  |
| WBL 40 2070-0.5 | 2000 x 700 x 840           | Linoleum  | 110 03 081.16 | 380.32  |



CM 400-3.1

| Description     | Dimensions<br>W x D x H mm | Worktop   | Part ref.     | Price £ |
|-----------------|----------------------------|-----------|---------------|---------|
| WBM 40 1570-3.1 | 1500 x 700 x 840           | Multiplex | 110 07 069.03 | 483.71  |
| WBM 40 2070-3.1 | 2000 x 700 x 840           | Multiplex | 110 07 073.03 | 524.58  |
| WBL 40 1570-3.1 | 1500 x 700 x 840           | Linoleum  | 110 07 080.03 | 560.50  |
| WBL 40 2070-3.1 | 2000 x 700 x 840           | Linoleum  | 110 07 081.03 | 605.16  |

## Standard paint finish

|          |                     |
|----------|---------------------|
| Housing: | RAL 7035 light grey |
| Fronts:  | RAL 5015 blue .03   |

## Alternative front colours (no extra charge)

|                         |                     |                     |                     |                     |
|-------------------------|---------------------|---------------------|---------------------|---------------------|
| RAL 7035 light grey     | RAL 7035 light grey | RAL 7035 light grey | RAL 7035 light grey | RAL 7035 light grey |
| RAL 7035 light grey .16 | RAL 7001 grey .01   | RAL 6011 green .02  | RAL 3001 red .04    | RAL 1023 yellow .12 |

(Please replace the order ref. suffix from .03 to that for your required colour)

# Workbench WB

Dimensions: Width 1500/2000 x Depth 700 x Height 840 mm



CM 800-5.2

| Description     | Dimensions<br>W x D x H mm | Worktop   | Part ref.     | Price £ |
|-----------------|----------------------------|-----------|---------------|---------|
| WBM 40 1570-5.2 | 1500 x 700 x 840           | Multiplex | 110 13 181.03 | 575.13  |
| WBM 40 2070-5.2 | 2000 x 700 x 840           | Multiplex | 110 13 188.03 | 613.43  |
| WBL 40 1570-5.2 | 1500 x 700 x 840           | Linoleum  | 110 13 210.03 | 651.60  |
| WBL 40 2070-5.2 | 2000 x 700 x 840           | Linoleum  | 110 13 213.03 | 692.81  |



CM 800-6.1

| Description    | Dimensions<br>W x D x H mm | Worktop   | Part ref.     | Price £ |
|----------------|----------------------------|-----------|---------------|---------|
| WBM40 1570-6.1 | 1500 x 700 x 840           | Multiplex | 110 13 182.03 | 636.98  |
| WBM40 2070-6.1 | 2000 x 700 x 840           | Multiplex | 110 13 189.03 | 904.64  |
| WBL40 1570-6.1 | 1500 x 700 x 840           | Linoleum  | 110 13 211.03 | 713.88  |
| WBL40 2070-6.1 | 2000 x 700 x 840           | Linoleum  | 110 13 214.03 | 747.12  |



CK 800-5.1

CK 800R-4.1

| Description     | Dimensions<br>W x D x H mm | Worktop   | Part ref.     | Price £ |
|-----------------|----------------------------|-----------|---------------|---------|
| WBM 40 2070-9.1 | 2000 x 700 x 840           | Multiplex | 110 13 190.03 | 914.55  |
| WBL 40 2070-9.1 | 2000 x 700 x 840           | Linoleum  | 110 13 215.03 | 994.82  |

## Standard paint finish

|          |                     |
|----------|---------------------|
| Housing: | RAL 7035 light grey |
| Fronts:  | RAL 5015 blue .03   |

## Alternative front colours (no extra charge)

|                         |                     |                     |                     |                     |
|-------------------------|---------------------|---------------------|---------------------|---------------------|
| RAL 7035 light grey     | RAL 7035 light grey | RAL 7035 light grey | RAL 7035 light grey | RAL 7035 light grey |
| RAL 7035 light grey .16 | RAL 7001 grey .01   | RAL 6011 green .02  | RAL 3001 red .04    | RAL 1023 yellow .12 |

(Please replace the order ref. suffix from .03 to that for your required colour)

Drawer  
Cabinets

Workbenches

Workstation  
Systems APS

Mobile  
Equipment

Storage  
Cupboards

Combination Drawer  
& Shelving System

Drawer  
Dividers

Perfo® System

CNC System

Cases

# Workbench WB

Dimensions: Width 1500/2000 x Depth 700 x Height 790–940 mm



- Suitable for assembly work
- continuous height adjustment from 790-940 mm
- Choose from 2 worktop finishes (Thickness 40 mm)
- Load capacity per drawer 100 kg (except S1)
- Supplied flat packed for self assembly. We can offer a full assembly service, please contact us for details.
- Drawer divider systems see page 210-225

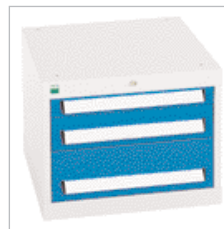

With CK and CM series drawer cabinets – see page 24/25 and 30/31 for more details



| Description  | Dimensions<br>W x D x H mm | Worktop   | Part ref.     | Price £ |
|--------------|----------------------------|-----------|---------------|---------|
| WBM 1570-1.1 | 1500 x 700 x 790-940       | Multiplex | 110 04 022.16 | 298.56  |
| WBM 2070-1.1 | 2000 x 700 x 790-940       | Multiplex | 110 04 024.16 | 335.99  |
| WBL 1570-1.1 | 1500 x 700 x 790-940       | Linoleum  | 110 04 027.16 | 409.37  |
| WBL 2070-1.1 | 2000 x 700 x 790-940       | Linoleum  | 110 04 028.16 | 381.93  |

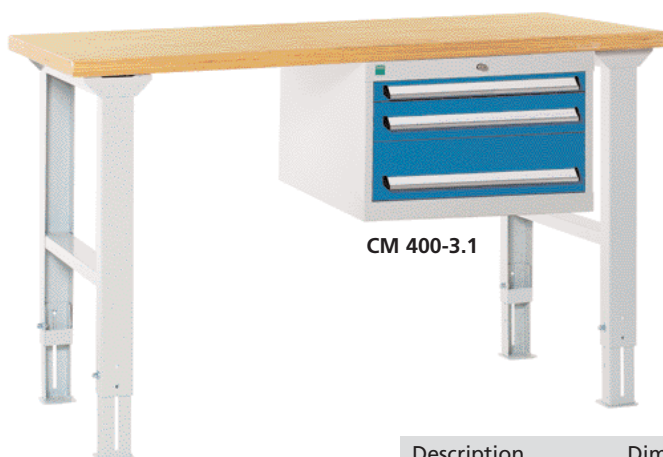

| Description     | Dimensions<br>W x D x H mm | Worktop   | Part ref.     | Price £ |
|-----------------|----------------------------|-----------|---------------|---------|
| WBM 40 1570-3.3 | 1500 x 700 x 790-940       | Multiplex | 110 07 070.03 | 483.99  |
| WBM 40 2070-3.3 | 2000 x 700 x 790-940       | Multiplex | 110 07 072.03 | 536.13  |
| WBL 40 1570-3.3 | 1500 x 700 x 790-940       | Linoleum  | 110 07 082.03 | 560.68  |
| WBL 40 2070-3.3 | 2000 x 700 x 790-940       | Linoleum  | 110 07 083.03 | 612.24  |

## Standard paint finish

|          |                     |
|----------|---------------------|
| Housing: | RAL 7035 light grey |
| Fronts:  | RAL 5015 blue .03   |

## Alternative front colours (no extra charge)

|                         |                     |                     |                     |                     |
|-------------------------|---------------------|---------------------|---------------------|---------------------|
| RAL 7035 light grey     | RAL 7035 light grey | RAL 7035 light grey | RAL 7035 light grey | RAL 7035 light grey |
| RAL 7035 light grey .16 | RAL 7001 grey .01   | RAL 6011 green .02  | RAL 3001 red .04    | RAL 1023 yellow .12 |

(Please replace the order ref. suffix from .03 to that for your required colour)

# Workbench WB

Dimensions: Width 1500/2000 x Depth 700 x Height 940 mm



CM 900-6.2

| Description     | Dimensions<br>W x D x H mm | Worktop   | Part ref.     | Price £ |
|-----------------|----------------------------|-----------|---------------|---------|
| WBM 40 1570-6.3 | 1500 x 700 x 940           | Multiplex | 110 13 186.03 | 628.21  |
| WBM 40 2070-6.3 | 2000 x 700 x 940           | Multiplex | 110 13 193.03 | 663.77  |
| WBL 40 1570-6.3 | 1500 x 700 x 940           | Linoleum  | 110 13 212.03 | 704.66  |
| WBL 40 2070-6.3 | 2000 x 700 x 940           | Linoleum  | 110 13 216.03 | 744.59  |



CK 900-6.1

CK 900R-4.1

| Description      | Dimensions<br>W x D x H mm | Worktop   | Part ref.     | Price £ |
|------------------|----------------------------|-----------|---------------|---------|
| WBM 40 2070-10.1 | 2000 x 700 x 940           | Multiplex | 110 13 194.03 | 935.89  |
| WBL 40 2070-10.1 | 2000 x 700 x 940           | Linoleum  | 110 13 217.03 | 1018.32 |

## Standard paint finish

|          |                     |
|----------|---------------------|
| Housing: | RAL 7035 light grey |
| Fronts:  | RAL 5015 blue .03   |

## Alternative front colours (no extra charge)

|                         |                     |                     |                     |                     |
|-------------------------|---------------------|---------------------|---------------------|---------------------|
| RAL 7035 light grey     | RAL 7035 light grey | RAL 7035 light grey | RAL 7035 light grey | RAL 7035 light grey |
| RAL 7035 light grey .16 | RAL 7001 grey .01   | RAL 6011 green .02  | RAL 3001 red .04    | RAL 1023 yellow .12 |

(Please replace the order ref. suffix from .03 to that for your required colour)

Drawer  
Cabinets

Workbenches

Workstation  
Systems APS

Mobile  
Equipment

Storage  
Cupboards

Combination Drawer  
& Shelving System

Drawer  
Dividers

Perfo® System

CNC System

Cases

Drawer Cabinets

Workbenches

Workstation Systems APS

Mobile Equipment

Storage Cupboards

Combination Drawer & Shelving System

Drawer Dividers

Perfo® System

CNC System

Cases



# Hexagonal group workstations

Dimensions: Width 2500 x Depth 2165 x Height 840/940 mm

- Space: Width 2500 x Depth 2165 mm
- Height: 840 and 940 mm
- Worktop type: Beech multiplex, 40 mm Edge Length 1250 mm
- Central locking mechanism with 2 keys
- Load capacity per drawer: 100 kg – Normal slide
- Drawer pan internal measurements: W 520 x D 520 mm
- Drawer blocking mechanism is optionally available
- Drawer dividers – see page 210-225

## SWM40-1250-30.1– with working height 840 mm

Cabinet measurements: W 600 x D 600 x H 800 mm

Drawer configuration: 2 x 100, 2 x 150, 1 x 200 mm



## SWM40-1250-36.1– with working height 940 mm

Cabinet measurements: W 600 x D 600 x H 900 mm

Drawer configuration: 1 x 50, 1 x 100, 3 x 150, 1 x 200 mm



| Description     | Dimensions W x D x H mm | with cabinet type | Part ref.     | Price £ |
|-----------------|-------------------------|-------------------|---------------|---------|
| SWM40 1250-30.1 | 2500 x 2165 x 840       | 6x CM 800-5.2     | 110 24 006.03 | 3426.10 |
| SWM40 1250-36.1 | 2500 x 2165 x 940       | 6x CM 900-6.1     | 110 24 008.03 | 3787.48 |

### Standard paint finish

|          |                     |
|----------|---------------------|
| Housing: | RAL 7035 light grey |
| Fronts:  | RAL 5015 blue .03   |

### Alternative front colours (no extra charge)

|                         |                     |                     |                     |                     |
|-------------------------|---------------------|---------------------|---------------------|---------------------|
| RAL 7035 light grey     | RAL 7035 light grey | RAL 7035 light grey | RAL 7035 light grey | RAL 7035 light grey |
| RAL 7035 light grey .16 | RAL 7001 grey .01   | RAL 6011 green .02  | RAL 3001 red .04    | RAL 1023 yellow .12 |

(Please replace the order ref. suffix from .03 to that for your required colour)

Drawer Cabinets

Workbenches

Workstation Systems APS

Mobile Equipment

Storage Cupboards

Combination Drawer & Shelving System

Drawer Dividers

Perfo® System

CNC System

Cases

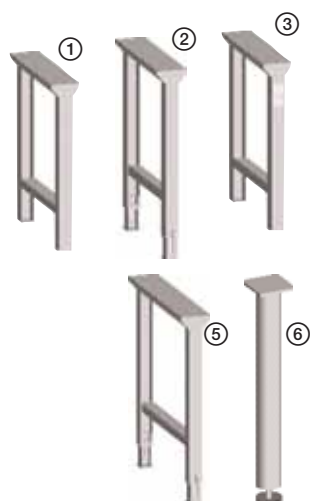

## Workbench legs

| Fig. | Description  | Dimensions<br>W x D x H mm | Part ref.     | Price £ |
|------|--|----------------------------|---------------|---------|
| ①    | F1 - fixed height                                    | 160/80 x 640 x 800         | 114 01 028.16 | 33.47   |
| ②    | F2 - adjustable height*                              | 160/80 x 640 x 750-900     | 114 01 029.16 | 37.18   |
| ③    | F3 - can be configured with electrical accessories** | 160/80 x 640 x 800         | 114 01 030.16 | 44.61   |
| ⑤    | F5 - adjustable height*                              | 160/80 x 820 x 750-900     | 114 01 091.16 | 45.73   |
| ⑥    | F6 - round, incl. levelling foot                     | Ø 80 x H 200-1500*         | 114 01 076.16 | 48.38   |

\* Please specify required height when ordering

\*\* Contact your local bott partner for details.



## Worktops

Further versions on request.

| Description   | Dimensions<br>W x D x S mm | Part ref.     | Price £ |
|---|----------------------------|---------------|---------|
| Hexagonal-worktop, Beech multiplex 40 mm<br>Edge length 1250 mm, 2 pieces | 2500 x 2165 x 40           | 112 01 086.08 | 766.42  |
| Hexagonal-worktop, Beech 40 mm<br>Edge length 1250 mm, 2 pieces           | 2500 x 2165 x 40           | 112 01 086.07 | 1253.73 |
| Hexagonal-worktop, Beech multiplex 50 mm<br>Edge length 1250 mm, 2 pieces | 2500 x 2165 x 50           | 112 01 087.08 | 826.76  |

## Sheet-steel tool storage shelves



## Beech multiplex shelves



| Description | for workbench                    | Dimensions W x D x H mm | Part ref.     | Price £ |
|-------------|----------------------------------|-------------------------|---------------|---------|
| Shelf WZ 5  | WB 1570 – with 1 base cabinet CM | 835 x 480 x 22          | 121 01 116.16 | 73.51   |
| Shelf WZ 6  | WB 1570 – without base cabinet   | 1335 x 480 x 22         | 121 01 117.16 | 88.08   |
| Shelf WZ 6  | WB 2070 – with 1 base cabinet CM | 1335 x 480 x 22         | 121 01 117.16 | 88.08   |
| Shelf WZ 7  | WB 2070 – without base cabinet   | 1835 x 480 x 22         | 121 01 118.16 | 112.34  |
| Shelf       | WB 1570 – without base cabinet   | 1410 x 280 x 25         | 112 01 076    | 55.40   |
| Shelf       | WB 1570 – without base cabinet   | 1410 x 530 x 25         | 112 01 074    | 77.01   |
| Shelf       | WB 2070 – without base cabinet   | 1910 x 280 x 25         | 112 01 077    | 79.08   |
| Shelf       | WB 2070 – without base cabinet   | 1910 x 530 x 25         | 112 01 075    | 108.60  |

# Workbench accessories and individual components for WB and hexagonal group workstations

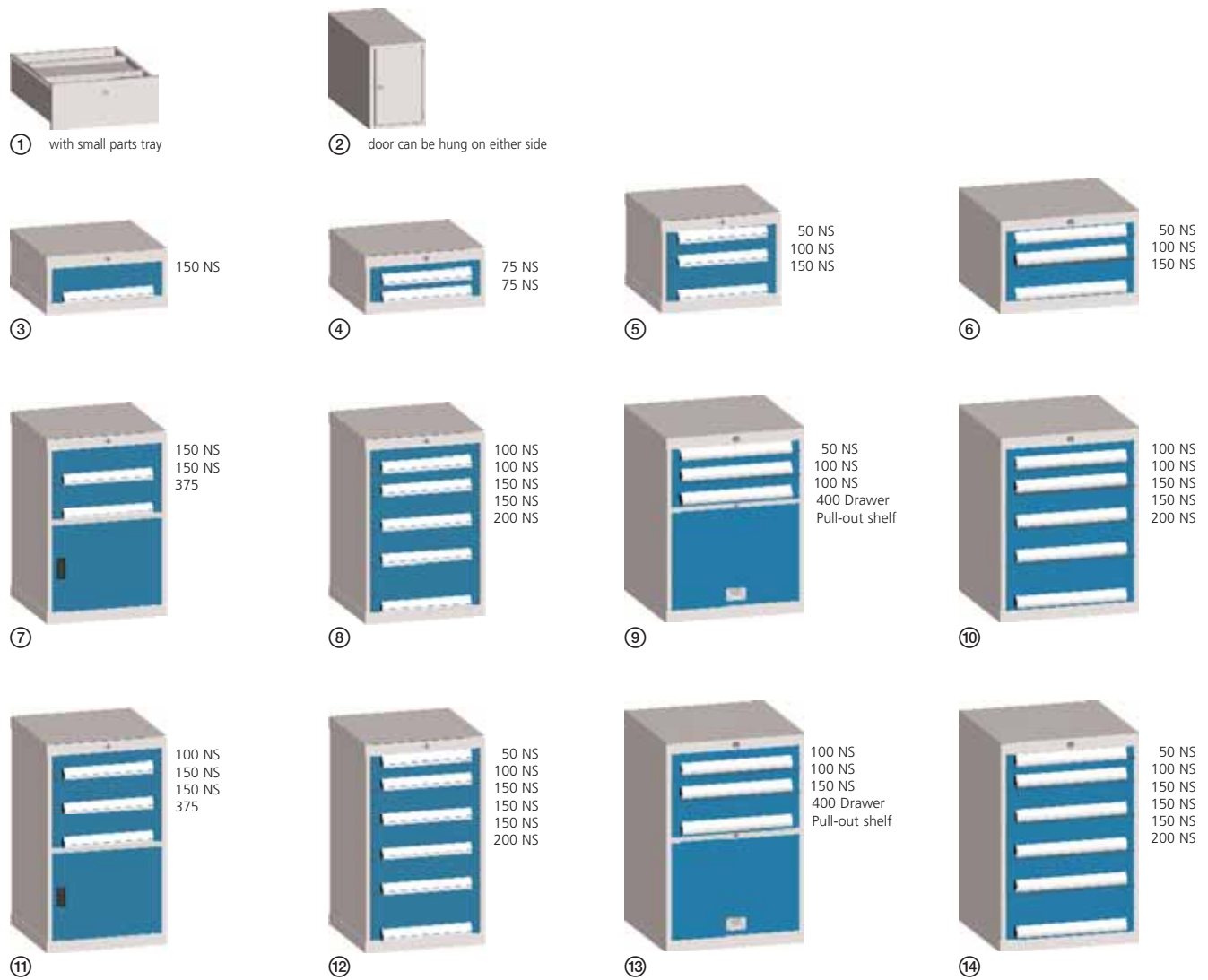

| Fig. | Description      | Dimensions<br>W x D x H mm | Part ref.     | Price £ |
|------|------------------|----------------------------|---------------|---------|
| ①    | S1-Single drawer | 470 x 600 x 200            | 105 59 001.16 | 109.47  |
| ②    | V1 Cupboard      | 242 x 600 x 360            | 100 33 004.16 | 67.17   |
| ③    | CK-250-1.1       | 520 x 520 x 250            | 100 27 020.03 | 167.63  |
| ④    | CK-250-2.1       | 520 x 520 x 250            | 100 27 021.03 | 186.88  |
| ⑤    | CK-400-3.1       | 520 x 520 x 400            | 100 27 023.03 | 262.00  |
| ⑥    | CM-400-3.1       | 600 x 600 x 400            | 100 02 088.03 | 300.00  |
| ⑦    | CK-800R-3.1      | 520 x 520 x 800            | 100 18 512.03 | 381.97  |
| ⑧    | CK-800-5.1       | 520 x 520 x 800            | 100 27 027.03 | 363.00  |
| ⑨    | CM-801-4.1       | 600 x 600 x 800            | 100 15 008.03 | 455.00  |
| ⑩    | CM-800-5.2       | 600 x 600 x 800            | 100 02 093.03 | 422.00  |
| ⑪    | CK-900R-4.1      | 520 x 520 x 900            | 100 18 514.03 | 440.00  |
| ⑫    | CK-900-6.1       | 520 x 520 x 900            | 100 27 031.03 | 412.00  |
| ⑬    | CM-901-4.1       | 600 x 600 x 900            | 100 15 009.03 | 474.00  |
| ⑭    | CM-900-6.1       | 600 x 600 x 900            | 100 02 097.03 | 494.00  |

For drawer dividers – see page 210-225.

### Standard paint finish

|          |                     |
|----------|---------------------|
| Housing: | RAL 7035 light grey |
| Fronts:  | RAL 5015 blue .03   |

### Alternative front colours (no extra charge)

|                         |                     |                     |                     |                     |
|-------------------------|---------------------|---------------------|---------------------|---------------------|
| RAL 7035 light grey     | RAL 7035 light grey | RAL 7035 light grey | RAL 7035 light grey | RAL 7035 light grey |
| RAL 7035 light grey .16 | RAL 7001 grey .01   | RAL 6011 green .02  | RAL 3001 red .04    | RAL 1023 yellow .12 |

(Please replace the order ref. suffix from .03 to that for your required colour)

Drawer Cabinets  
Workbenches  
Workstation Systems APS  
Mobile Equipment  
Storage Cupboards  
Combination Drawer & Shelving System  
Drawer Dividers  
Perfo® System  
CNC System  
Cases



# Workbench WL

Dimensions: Width 1500/2000 x Depth 700 x Height 840 mm



Drawer Cabinets

Workbenches

Workstation Systems APS

Mobile Equipment

Storage Cupboards

Combination Drawer & Shelving System

Drawer Dividers

Perfo® System

CNC System

Cases

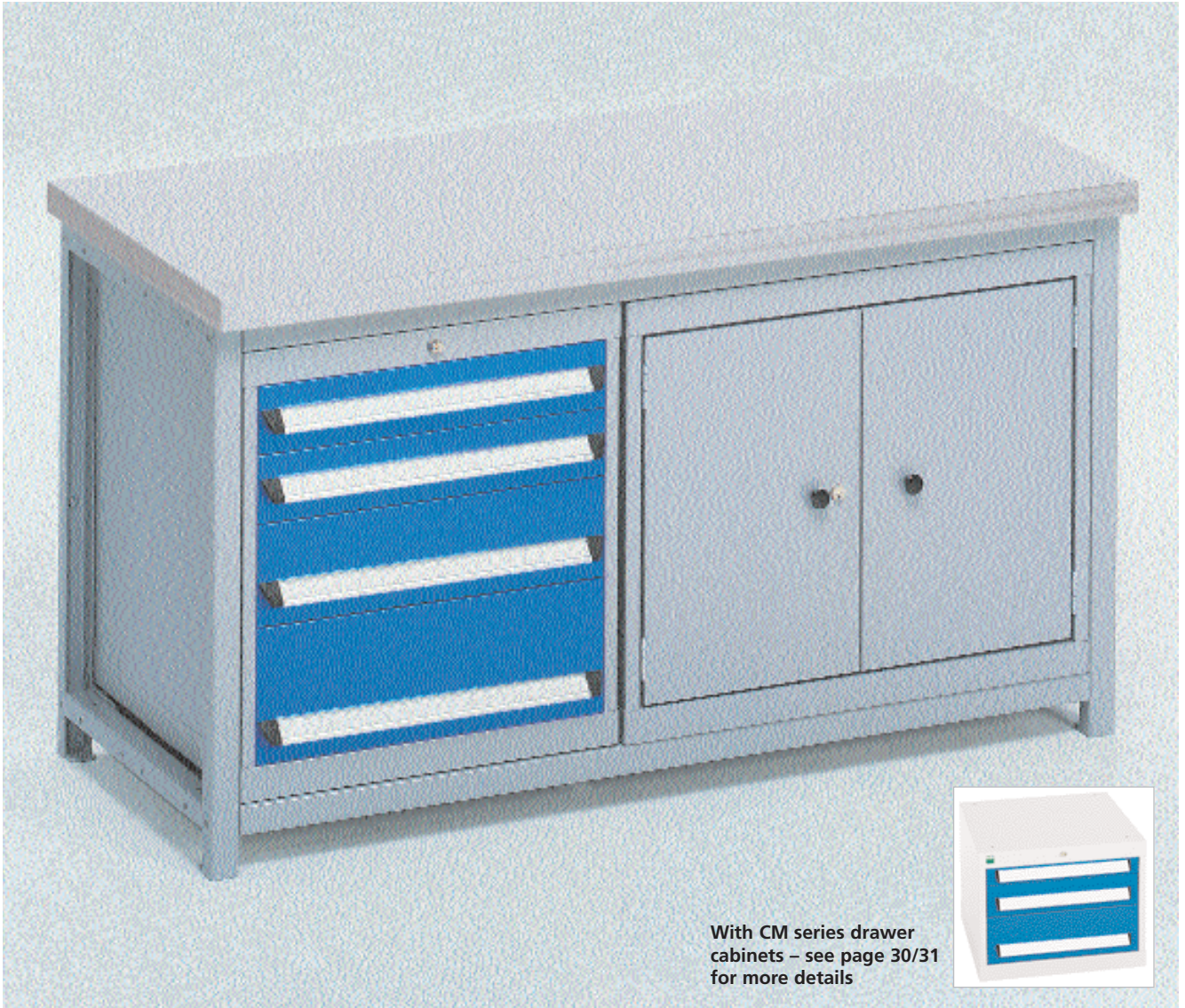

With CM series drawer cabinets – see page 30/31 for more details

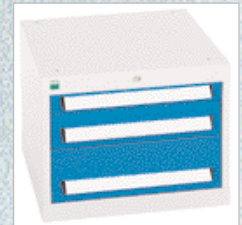

- Suitable for heavy assembly work
- Load capacity 600-1200 kg depending on worktop version
- Sturdy steel frame
- Choose from 2 worktop finishes (Thickness 40 mm)
- Load capacity per drawer 100 kg
- Supplied flat packed for self assembly. We can offer a full assembly service, please contact us for details.
- Frame size: W 1480 x D 600 x H 800 mm
- Drawer divider systems see page 210-225



Expansion modules can be added on



| Description     | Dimensions<br>W x D x H mm | Worktop   | Part ref.     | Price £ |
|-----------------|----------------------------|-----------|---------------|---------|
| WLM 40 1570-0.1 | 1500 x 700 x 840           | Multiplex | 110 02 048.16 | 215.72  |
| WLM 40 2070-0.1 | 2000 x 700 x 840           | Multiplex | 110 02 049.16 | 257.90  |
| WLL 40 1570-0.1 | 1500 x 700 x 840           | Linoleum  | 110 02 083.16 | 312.60  |
| WLL 40 2070-0.1 | 2000 x 700 x 840           | Linoleum  | 110 02 084.16 | 338.19  |

# Workbench WL

Dimensions: Width 1500/2000 x Depth 700 x Height 840 mm



| Description     | Dimensions<br>W x D x H mm | Worktop   | Part ref.     | Price £ |
|-----------------|----------------------------|-----------|---------------|---------|
| WLM 40 1570-0.2 | 1500 x 700 x 840           | Multiplex | 110 03 054.16 | 250.29  |
| WLM 40 2070-0.2 | 2000 x 700 x 840           | Multiplex | 110 03 055.16 | 296.55  |
| WLL 40 1570-0.2 | 1500 x 700 x 840           | Linoleum  | 110 03 082.16 | 250.29  |
| WLL 40 2070-0.2 | 2000 x 700 x 840           | Linoleum  | 110 03 083.16 | 376.86  |



| Description     | Dimensions<br>W x D x H mm | Worktop   | Part ref.     | Price £ |
|-----------------|----------------------------|-----------|---------------|---------|
| WLM 40 1570-4.1 | 1500 x 700 x 840           | Multiplex | 110 08 129.03 | 575.09  |
| WLM 40 2070-4.1 | 2000 x 700 x 840           | Multiplex | 110 08 133.03 | 612.59  |
| WLL 40 1570-4.1 | 1500 x 700 x 840           | Linoleum  | 110 08 258.03 | 666.13  |
| WLL 40 2070-4.1 | 2000 x 700 x 840           | Linoleum  | 110 08 259.03 | 707.46  |

Drawer configuration (Normal slide):  
2 x 100, 1 x 150, 1 x 200 mm



| Description     | Dimensions<br>W x D x H mm | Worktop   | Part ref.     | Price £ |
|-----------------|----------------------------|-----------|---------------|---------|
| WLM 40 1570-5.1 | 1500 x 700 x 840           | Multiplex | 110 16 133.03 | 647.08  |
| WLM 40 2070-5.1 | 2000 x 700 x 840           | Multiplex | 110 16 132.03 | 770.43  |
| WLL 40 1570-5.1 | 1500 x 700 x 840           | Linoleum  | 110 16 185.03 | 868.28  |
| WLL 40 2070-5.1 | 2000 x 700 x 840           | Linoleum  | 110 16 186.03 | 914.29  |

Drawer configuration (Normal slide):  
2 x 100, 1 x 150, 1 x 200 mm  
Double door cupboard with shelf

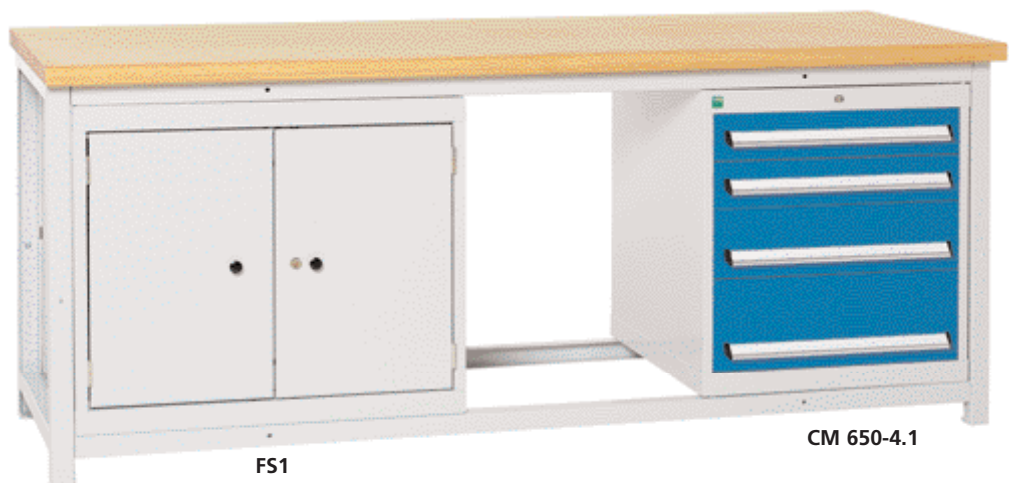

## Standard paint finish

|          |                     |
|----------|---------------------|
| Housing: | RAL 7035 light grey |
| Fronts:  | RAL 5015 blue .03   |

## Alternative front colours (no extra charge)

|                         |                     |                     |                     |                     |
|-------------------------|---------------------|---------------------|---------------------|---------------------|
| RAL 7035 light grey     | RAL 7035 light grey | RAL 7035 light grey | RAL 7035 light grey | RAL 7035 light grey |
| RAL 7035 light grey .16 | RAL 7001 grey .01   | RAL 6011 green .02  | RAL 3001 red .04    | RAL 1023 yellow .12 |

(Please replace the order ref. suffix from .03 to that for your required colour)

Drawer  
Cabinets

Workbenches

Workstation  
Systems APS

Mobile  
Equipment

Storage  
Cupboards

Combination Drawer  
& Shelving System

Drawer  
Dividers

Perfo® System

CNC System

Cases

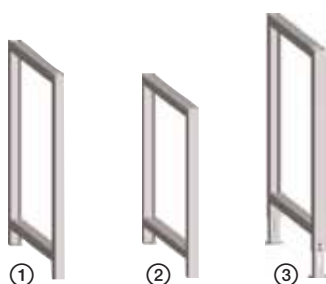

## Workbench legs

| Fig. | Description        | Dimensions<br>W x D x H mm | Part ref.     | Price £ |
|------|--------------------|----------------------------|---------------|---------|
| ①    | FL1 (O/M = 1 pce.) | 45 x 600 x 800             | 114 01 032.16 | 19.33   |
|      | FL1 (O/M = 2 pcs.) | 45 x 600 x 800             | 114 01 046.16 | 38.66   |
| ②    | FL2 (O/M = 1 pce.) | 45 x 600 x 665             | 114 01 040.16 | 17.11   |
|      | FL2 (O/M = 2 pcs.) | 45 x 600 x 665             | 114 01 047.16 | 34.20   |
| ③    | FL3 (O/M = 1 pce.) | 45 x 600 x 800-950         | 114 01 069.16 | 40.61   |



## Cross member set

set 1 for worktables WL-1570: 2 x cross member top, 1 x cross member bottom

set 2 for worktables WL-2070: 2 x cross member top, 1 x cross member bottom

set 3 for worktables WL-1570: 2 x cross member top (Shelf must be ordered separately)

set 4 for worktables WL-2070: 2 x cross member top (Shelf must be ordered separately)

| Description   | for worktable<br>Width mm | Part ref.     | Price £ |
|---|---------------------------|---------------|---------|
| set 1 – 2x cross member top, 1x cross member bottom   | 1500                      | 121 10 055.16 | 33.47   |
| set 2 – 2 x cross member top, 1 x cross member bottom | 2000                      | 121 10 057.16 | 41.64   |
| set 3 – 2 x cross member top                          | 1500                      | 121 10 060.16 | 23.79   |
| set 4 – 2 x cross member top                          | 2000                      | 121 10 061.16 | 29.74   |

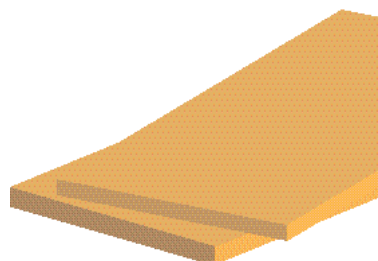

## Worktops

For full descriptions and other worktops please refer to page 100-104

| Description                    | Dimensions<br>W x D x H mm | Part ref.     | Price £ |
|--------------------------------|----------------------------|---------------|---------|
| Worktop Beech multiplex, 30 mm | 1500 x 700 x 30            | 112 01 114.08 | 96.00   |
| Worktop Beech multiplex, 30 mm | 2000 x 700 x 30            | 112 01 118.08 | 133.00  |
| Worktop Beech multiplex, 40 mm | 1500 x 700 x 40            | 112 01 003.08 | 101.00  |
| Worktop Beech multiplex, 40 mm | 2000 x 700 x 40            | 112 01 006.08 | 139.00  |
| Worktop Beech multiplex, 50 mm | 1500 x 700 x 50            | 112 01 002.08 | 139.26  |
| Worktop Beech multiplex, 50 mm | 2000 x 700 x 50            | 112 01 005.08 | 200.47  |



## Shelves

sheet steel 45 mm thick

| Description | for worktable | Dimensions<br>W x D x H mm | Part ref.     | Price £ |
|-------------|---------------|----------------------------|---------------|---------|
| WZ1         | WL-1570       | 1390 x 360 x 45            | 121 01 119.16 | 37.35   |
| WZ2         | WL-2070       | 1890 x 360 x 45            | 121 01 120.16 | 44.02   |
| WZ3         | WL-1570       | 1390 x 600 x 45            | 121 01 121.16 | 63.49   |
| WZ4         | WL-2070       | 1890 x 600 x 45            | 121 01 122.16 | 61.58   |

# Workbench accessories and individual components for WL



① with small parts tray



② door can be hung on either side



150 NS

③



75 NS  
75 NS

④

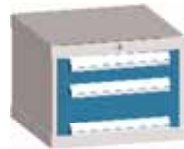

50 NS  
100 NS  
150 NS

⑤



50 NS  
100 NS  
150 NS

⑥



Hinged door  
Shelf

⑦



⑧

⑧ **Support rail TL 1**  
for fitting cabinets to the underside  
of bench frameworks  
for V 1 - 1 piece  
for S 1 and cabinets - 2 piece

| Fig. | Description      | Dimensions<br>W x D x H mm | Part ref.     | Price £ |
|------|------------------|----------------------------|---------------|---------|
| ①    | S1-Single drawer | 470 x 600 x 200            | 105 59 001.16 | 109.47  |
| ②    | V1-Cupboard      | 242 x 600 x 360            | 100 33 004.16 | 67.17   |
| ③    | CK-250-1.1       | 520 x 520 x 250            | 100 27 020.03 | 167.63  |
| ④    | CK-250-2.1       | 520 x 520 x 250            | 100 27 021.03 | 186.88  |
| ⑤    | CK-400-3.1       | 520 x 520 x 400            | 100 27 023.03 | 262.00  |
| ⑥    | CM-400-3.1       | 600 x 600 x 400            | 100 02 088.03 | 300.00  |
| ⑦    | FS 1             | 780 x 600 x 650            | 100 18 041.16 | 223.44  |
| ⑧    | TL 1             |                            | 121 10 054.16 | 3.34    |

Drawer divider systems – see page 210-225.

## Standard paint finish

|          |                     |
|----------|---------------------|
| Housing: | RAL 7035 light grey |
| Fronts:  | RAL 5015 blue .03   |

## Alternative front colours (no extra charge)

|                         |                     |                     |                     |                     |
|-------------------------|---------------------|---------------------|---------------------|---------------------|
| RAL 7035 light grey     | RAL 7035 light grey | RAL 7035 light grey | RAL 7035 light grey | RAL 7035 light grey |
| RAL 7035 light grey .16 | RAL 7001 grey .01   | RAL 6011 green .02  | RAL 3001 red .04    | RAL 1023 yellow .12 |

(Please replace the order ref. suffix from .03 to that for your required colour)

Drawer  
Cabinets

Workbenches

Workstation  
Systems APS

Mobile  
Equipment

Storage  
Cupboards

Combination Drawer  
& Shelving System

Drawer  
Dividers

Perfo® System

CNC System

Cases

Drawer  
Cabinets

Workbenches

Workstation  
Systems APS

Mobile  
Equipment

Storage  
Cupboards

Combination Drawer  
& Shelving System

Drawer  
Dividers

Perfo® System

CNC System

Cases



## »Mobility kit«



cannot be used in combination with the height adjustment kit, 4 pieces, 4 swivel castors Ø 100 mm, 2 castors having locking brakes. Height 120 mm.

| Description  | Part ref.  | Price £ |
|--------------|------------|---------|
| Mobility kit | 809 06 008 | 64.02   |

## »Height adjustment kit«

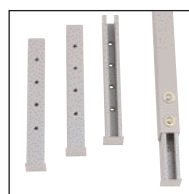

Cannot be used in combination with the mobility kit, 4 pieces, Adjustment range 0-150 mm in 50 mm increments or infinitely variable, Height adjustable from 800 to 950 mm (without plate). Can be used to adjust bench.

| Description           | Part ref.     | Price £ |
|-----------------------|---------------|---------|
| Height adjustment kit | 080 30 462.16 | 23.13   |

# Modular workbenches KWB



Dimensions: Width 750 x Depth 700 x Height 840 mm

- Suitable for heavy assembly work
- Load capacity 600-1200 kg depending on worktop version
- Sturdy steel base frame
- Choose from 2 worktop finishes (Thickness 40 mm)
- Modular system that can be expanded as required.
- Load capacity per drawer 100 kg – Normal slide
- Drawer pan internal measurements W 520 x D 520 mm
- Drawer divider systems see page 210-225
- Central locking mechanism for doors and drawers
- Delivered assembled
- 230 mm floor clearance



| Description       | Dimensions<br>W x D x H mm | Worktop   | Part ref.     | Price £ |
|-------------------|----------------------------|-----------|---------------|---------|
| KWBM 40 0770M-0.1 | 750 x 700 x 840            | Multiplex | 110 03 072.16 | 383.80  |
| KWBL 40 0770M-0.1 | 750 x 700 x 840            | Linoleum  | 110 03 084.16 | 450.71  |
| incl. 1 Shelf     |                            |           |               |         |



| Description                    | Dimensions<br>W x D x H mm | Worktop   | Part ref.     | Price £ |
|--------------------------------|----------------------------|-----------|---------------|---------|
| KWBM 40 0770M-1.1              | 750 x 700 x 840            | Multiplex | 110 16 169.03 | 420.03  |
| KWBL 40 0770M-1.1              | 750 x 700 x 840            | Linoleum  | 110 16 187.03 | 486.96  |
| 1 x Door 500 mm, incl. 1 Shelf |                            |           |               |         |



| Description                        | Dimensions<br>W x D x H mm | Worktop   | Part ref.     | Price £ |
|------------------------------------|----------------------------|-----------|---------------|---------|
| KWBM 40 0770M-2.1                  | 750 x 700 x 840            | Multiplex | 110 16 170.03 | 442.84  |
| KWBL 40 0770M-2.1                  | 750 x 700 x 840            | Linoleum  | 110 16 188.03 | 510.25  |
| 1 x Door 350 mm, 1 x Drawer 150 mm |                            |           |               |         |



| Description                          | Dimensions<br>W x D x H mm | Worktop   | Part ref.     | Price £ |
|--------------------------------------|----------------------------|-----------|---------------|---------|
| KWBM 40 0770M-3.1                    | 750 x 700 x 840            | Multiplex | 110 09 066.03 | 500.88  |
| KWBL 40 0770M-3.1                    | 750 x 700 x 840            | Linoleum  | 110 09 072.03 | 567.79  |
| 2 x Drawer 150 mm, 1 x Drawer 200 mm |                            |           |               |         |

## Standard paint finish

|          |                     |
|----------|---------------------|
| Housing: | RAL 7035 light grey |
| Fronts:  | RAL 5015 blue .03   |

## Alternative front colours (no extra charge)

|                         |                     |                     |                     |                     |
|-------------------------|---------------------|---------------------|---------------------|---------------------|
| RAL 7035 light grey     | RAL 7035 light grey | RAL 7035 light grey | RAL 7035 light grey | RAL 7035 light grey |
| RAL 7035 light grey .16 | RAL 7001 grey .01   | RAL 6011 green .02  | RAL 3001 red .04    | RAL 1023 yellow .12 |

(Please replace the order ref. suffix from .03 to that for your required colour)

Drawer  
Cabinets

Workbenches

Workstation  
Systems APS

Mobile  
Equipment

Storage  
Cupboards

Combination Drawer  
& Shelving System

Drawer  
Dividers

Perfo® System

CNC System

Cases

# Modular workbenches KWB

Dimensions: Width 1500 x Depth 700 x Height 840 mm



- Suitable for heavy assembly work
- Load capacity 600-1200 kg depending on worktop version
- Sturdy steel base frame
- Choose from 2 worktop finishes (Thickness 40 mm)
- Modular system that can be expanded as required.
- Load capacity per drawer 100 kg – Normal slide
- Drawer pan internal measurements W 520 x D 520 mm
- Drawer divider systems – see page 210-225
- Central locking mechanism for doors and drawers
- Delivered assembled
- 230 mm floor clearance

Drawer Cabinets

Workbenches

Workstation Systems APS

Mobile Equipment

Storage Cupboards

Combination Drawer & Shelving System

Drawer Dividers

Perfo® System

CNC System

Cases



| Description       | Dimensions<br>W x D x H mm | Worktop   | Part ref.     | Price £ |
|-------------------|----------------------------|-----------|---------------|---------|
| KWBM 40 1570M-0.1 | 1500 x 700 x 840           | Multiplex | 110 03 017.16 | 478.44  |
| KWBL 40 1570M-0.1 | 1500 x 700 x 840           | Linoleum  | 110 03 085.16 | 571.91  |
| incl. 2 Shelves   |                            |           |               |         |



| Description                    | Dimensions<br>W x D x H mm | Worktop   | Part ref.     | Price £ |
|--------------------------------|----------------------------|-----------|---------------|---------|
| KWBM 40 1570M-1.1              | 1500 x 700 x 840           | Multiplex | 110 16 094.03 | 505.72  |
| KWBL 40 1570M-1.1              | 1500 x 700 x 840           | Linoleum  | 110 16 189.03 | 607.66  |
| 1 x Door 500 mm, incl. 1 Shelf |                            |           |               |         |



| Description                      | Dimensions<br>W x D x H mm | Worktop   | Part ref.     | Price £ |
|----------------------------------|----------------------------|-----------|---------------|---------|
| KWBM 40 1570M-2.1                | 1500 x 700 x 840           | Multiplex | 110 16 097.03 | 513.20  |
| KWBL 40 1570M-2.1                | 1500 x 700 x 840           | Linoleum  | 110 16 190.03 | 536.20  |
| 2 x Door 500 mm, incl. 2 Shelves |                            |           |               |         |

## Standard paint finish

|          |                     |
|----------|---------------------|
| Housing: | RAL 7035 light grey |
| Fronts:  | RAL 5015 blue .03   |

## Alternative front colours (no extra charge)

|                         |                     |                     |                     |                     |
|-------------------------|---------------------|---------------------|---------------------|---------------------|
| RAL 7035 light grey     | RAL 7035 light grey | RAL 7035 light grey | RAL 7035 light grey | RAL 7035 light grey |
| RAL 7035 light grey .16 | RAL 7001 grey .01   | RAL 6011 green .02  | RAL 3001 red .04    | RAL 1023 yellow .12 |

(Please replace the order ref. suffix from .03 to that for your required colour)

# Modular workbenches KWB

Dimensions: Width 1500 x Depth 700 x Height 840 mm



| Description  | Dimensions<br>W x D x H mm | Worktop   | Part ref.     | Price £ |
|--|----------------------------|-----------|---------------|---------|
| KWBM 40 1570M-3.1  | 1500 x 700 x 840           | Multiplex | 110 16 103.03 | 592.83  |
| KWBL 40 1570M-3.1  | 1500 x 700 x 840           | Linoleum  | 110 16 191.03 | 669.32  |
| 1 x Drawer 150 mm, 1 x Door 350 mm, 1 x Door 500 mm, incl. 1 Shelf |                            |           |               |         |



| Description  | Dimensions<br>W x D x H mm | Worktop   | Part ref.     | Price £ |
|--|----------------------------|-----------|---------------|---------|
| KWBM 40 1570M-4.2  | 1500 x 700 x 840           | Multiplex | 110 16 105.03 | 605.22  |
| KWBL 40 1570M-4.2  | 1500 x 700 x 840           | Linoleum  | 110 16 192.03 | 628.22  |
| 2 x Drawer 150 mm, 1 x Drawer 200 mm, 1 x Door 500 mm, incl. 1 Shelf |                            |           |               |         |



| Description                       | Dimensions<br>W x D x H mm | Worktop   | Part ref.     | Price £ |
|-----------------------------------|----------------------------|-----------|---------------|---------|
| KWBM 40 1570M-6.1                 | 1500 x 700 x 840           | Multiplex | 110 16 107.03 | 698.67  |
| KWBL 40 1570M-6.1                 | 1500 x 700 x 840           | Linoleum  | 110 16 193.03 | 775.13  |
| 4 x Drawer 75 mm, 2 x Door 350 mm |                            |           |               |         |

## Standard paint finish

|          |                     |
|----------|---------------------|
| Housing: | RAL 7035 light grey |
| Fronts:  | RAL 5015 blue .03   |

## Alternative front colours (no extra charge)

|                         |                     |                     |                     |                     |
|-------------------------|---------------------|---------------------|---------------------|---------------------|
| RAL 7035 light grey     | RAL 7035 light grey | RAL 7035 light grey | RAL 7035 light grey | RAL 7035 light grey |
| RAL 7035 light grey .16 | RAL 7001 grey .01   | RAL 6011 green .02  | RAL 3001 red .04    | RAL 1023 yellow .12 |

(Please replace the order ref. suffix from .03 to that for your required colour)

Drawer  
Cabinets

Workbenches

Workstation  
Systems APS

Mobile  
Equipment

Storage  
Cupboards

Combination Drawer  
& Shelving System

Drawer  
Dividers

Perfo® System

CNC System

Cases



# Modular workbenches KWB

Dimensions: Width 1500 x Depth 700 x Height 840 mm



- Suitable for heavy assembly work
- Load capacity 600-1200 kg depending on worktop version
- Sturdy steel base frame
- Choose from 2 worktop finishes (Thickness 40 mm)
- Modular system that can be expanded as required.
- Load capacity per drawer 100 kg – Normal slide
- Drawer pan internal measurements W 520 x D 520 mm
- Drawer divider systems – see page 210-225
- Central locking mechanism for doors and drawers
- Delivered assembled
- 230 mm floor clearance

Drawer Cabinets

Workbenches

Workstation Systems APS

Mobile Equipment

Storage Cupboards

Combination Drawer & Shelving System

Drawer Dividers

Perfo® System

CNC System

Cases



| Description   | Dimensions<br>W x D x H mm | Worktop   | Part ref.     | Price £ |
|---|----------------------------|-----------|---------------|---------|
| KWBM 40 1570M-6.2   | 1500 x 700 x 840           | Multiplex | 110 16 109.03 | 721.19  |
| KWBL 40 1570M-6.2   | 1500 x 700 x 840           | Linoleum  | 110 16 194.03 | 797.65  |
| 1 x Door 350 mm, incl. 1 Shelf, 1 x Drawer 150 mm<br>2 x Drawer 75 mm, 1 x Drawer 150 mm, 1 x Drawer 200 mm |                            |           |               |         |



| Description                          | Dimensions<br>W x D x H mm | Worktop   | Part ref.     | Price £ |
|--------------------------------------|----------------------------|-----------|---------------|---------|
| KWBM 40 1570M-6.3                    | 1500 x 700 x 840           | Multiplex | 110 11 031.03 | 693.00  |
| KWBL 40 1570M-6.3                    | 1500 x 700 x 840           | Linoleum  | 110 11 050.03 | 716.00  |
| 4 x Drawer 150 mm, 2 x Drawer 200 mm |                            |           |               |         |



| Description        | Dimensions<br>W x D x H mm | Worktop   | Part ref.     | Price £ |
|--------------------|----------------------------|-----------|---------------|---------|
| KWBM 40 1570AM-1.1 | 1500 x 700 x 840           | Multiplex | 110 16 091.03 | 503.68  |
| KWBL 40 1570AM-1.1 | 1500 x 700 x 840           | Linoleum  | 110 16 195.03 | 580.15  |
| 1 x Door 500 mm    |                            |           |               |         |

## Standard paint finish

|          |                     |
|----------|---------------------|
| Housing: | RAL 7035 light grey |
| Fronts:  | RAL 5015 blue .03   |

## Alternative front colours (no extra charge)

|                         |                     |                     |                     |                     |
|-------------------------|---------------------|---------------------|---------------------|---------------------|
| RAL 7035 light grey     | RAL 7035 light grey | RAL 7035 light grey | RAL 7035 light grey | RAL 7035 light grey |
| RAL 7035 light grey .16 | RAL 7001 grey .01   | RAL 6011 green .02  | RAL 3001 red .04    | RAL 1023 yellow .12 |

(Please replace the order ref. suffix from .03 to that for your required colour)

# Modular workbenches KWB

Dimensions: Width 1500 x Depth 700 x Height 840 mm



| Description                        | Dimensions<br>W x D x H mm | Worktop   | Part ref.     | Price £ |
|------------------------------------|----------------------------|-----------|---------------|---------|
| KWBM 40 1570AM-2.1                 | 1500 x 700 x 840           | Multiplex | 110 16 077.03 | 547.69  |
| KWBL 40 1570AM-2.1                 | 1500 x 700 x 840           | Linoleum  | 110 16 196.03 | 624.16  |
| 1 x Drawer 150 mm, 1 x Door 350 mm |                            |           |               |         |

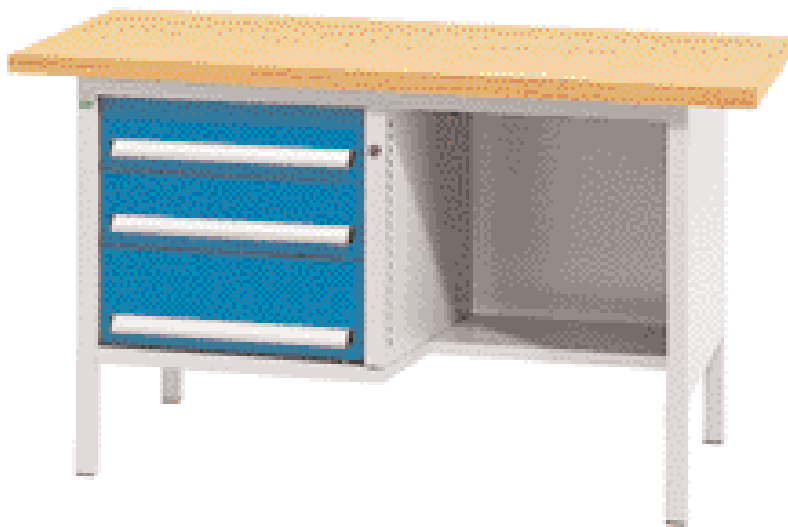

| Description                        | Dimensions<br>W x D x H mm | Worktop   | Part ref.     | Price £ |
|------------------------------------|----------------------------|-----------|---------------|---------|
| KWBM 40 1570AM-3.1                 | 1500 x 700 x 840           | Multiplex | 110 09 041.03 | 576.94  |
| KWBL 40 1570AM-3.1                 | 1500 x 700 x 840           | Linoleum  | 110 09 073.03 | 687.04  |
| 2 x Drawer 150 mm, 1 x Door 200 mm |                            |           |               |         |



| Description                       | Dimensions<br>W x D x H mm | Worktop   | Part ref.     | Price £ |
|-----------------------------------|----------------------------|-----------|---------------|---------|
| KWBM 40 1570AM-3.2                | 1500 x 700 x 840           | Multiplex | 110 16 087.03 | 587.68  |
| KWBL 40 1570AM-3.2                | 1500 x 700 x 840           | Linoleum  | 110 16 207.03 | 664.15  |
| 1 x Door 350 mm, 2 x Drawer 75 mm |                            |           |               |         |

## Standard paint finish

|          |                     |
|----------|---------------------|
| Housing: | RAL 7035 light grey |
| Fronts:  | RAL 5015 blue .03   |

## Alternative front colours (no extra charge)

|                         |                     |                     |                     |                     |
|-------------------------|---------------------|---------------------|---------------------|---------------------|
| RAL 7035 light grey     | RAL 7035 light grey | RAL 7035 light grey | RAL 7035 light grey | RAL 7035 light grey |
| RAL 7035 light grey .16 | RAL 7001 grey .01   | RAL 6011 green .02  | RAL 3001 red .04    | RAL 1023 yellow .12 |

(Please replace the order ref. suffix from .03 to that for your required colour)

Drawer  
Cabinets

Workbenches

Workstation  
Systems APS

Mobile  
Equipment

Storage  
Cupboards

Combination Drawer  
& Shelving System

Drawer  
Dividers

Perfo® System

CNC System

Cases

# Modular workbenches KWB



Dimensions: Width 2000 x Depth 700 x Height 840 mm

- Suitable for heavy assembly work
- Load capacity 600-1200 kg depending on worktop version
- Sturdy steel base frame
- Choose from 2 worktop finishes (Thickness 40 mm)
- Modular system that can be expanded as required.
- Load capacity per drawer 100 kg – Normal slide
- Drawer pan internal measurements W 520 x D 520 mm
- Drawer divider systems – see page 210-225
- Central locking mechanism for doors and drawers
- Delivered assembled
- 230 mm floor clearance

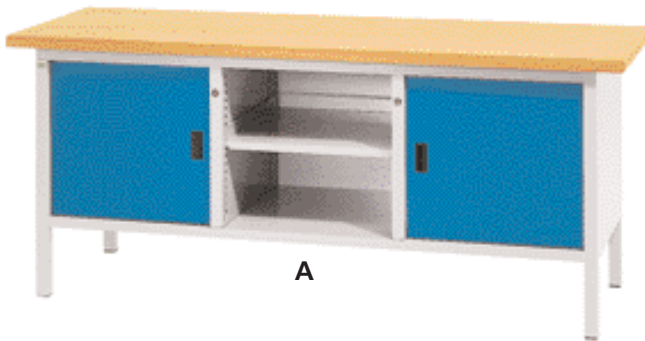

A

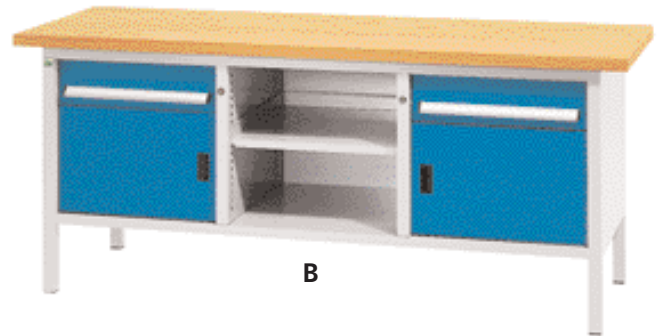

B

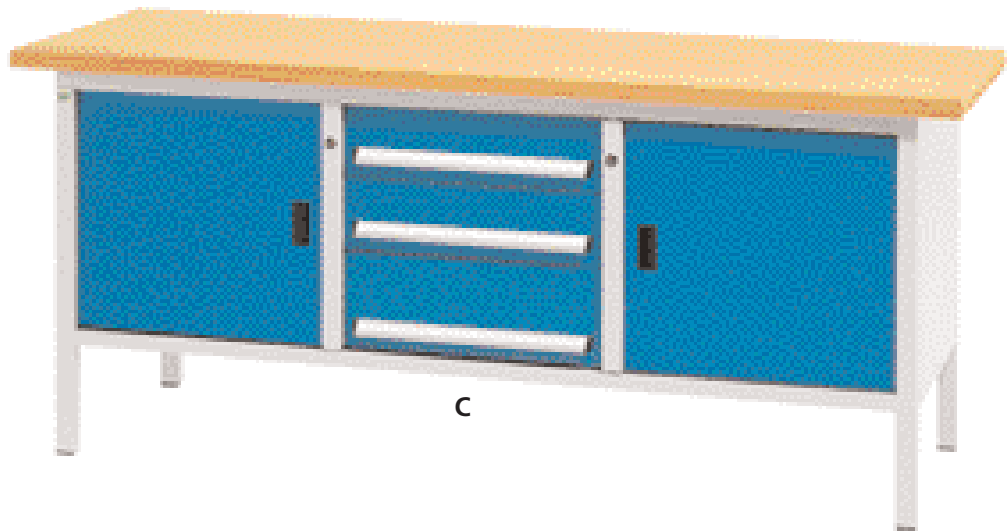

C

| Fig.   | Description       | Dimensions<br>W x D x H mm | Worktop   | Part ref.     | Price £ |
|--|-------------------|----------------------------|-----------|---------------|---------|
| A  | KWBM 40 2070M-2.1 | 2000 x 700 x 840           | Multiplex | 110 16 111.03 | 671.35  |
|  | KWBL 40 2070M-2.1 | 2000 x 700 x 840           | Linoleum  | 110 16 197.03 | 688.00  |
| 2 x Door 500 mm, incl. 3 Shelves                                       |                   |                            |           |               |         |
| B  | KWBM 40 2070M-4.2 | 2000 x 700 x 840           | Multiplex | 110 16 113.03 | 723.07  |
|  | KWBL 40 2070M-4.2 | 2000 x 700 x 840           | Linoleum  | 110 16 198.03 | 803.38  |
| 2 x Door 350 mm, 2 x Drawer 150 mm, incl. 1 Shelf                      |                   |                            |           |               |         |
| C  | KWBM 40 2070M-5.1 | 2000 x 700 x 840           | Multiplex | 110 16 117.03 | 795.84  |
|  | KWBL 40 2070M-5.1 | 2000 x 700 x 840           | Linoleum  | 110 16 200.03 | 812.84  |
| 2 x Door 500 mm, incl. 2 Shelves, 2 x Drawer 150 mm, 1 x Drawer 200 mm |                   |                            |           |               |         |

## Standard paint finish

|          |                     |
|----------|---------------------|
| Housing: | RAL 7035 light grey |
| Fronts:  | RAL 5015 blue .03   |

## Alternative front colours (no extra charge)

|                         |                     |                     |                     |                     |
|-------------------------|---------------------|---------------------|---------------------|---------------------|
| RAL 7035 light grey     | RAL 7035 light grey | RAL 7035 light grey | RAL 7035 light grey | RAL 7035 light grey |
| RAL 7035 light grey .16 | RAL 7001 grey .01   | RAL 6011 green .02  | RAL 3001 red .04    | RAL 1023 yellow .12 |

(Please replace the order ref. suffix from .03 to that for your required colour)

# Modular workbenches KWB

Dimensions: Width 2000 x Depth 700 x Height 840 mm

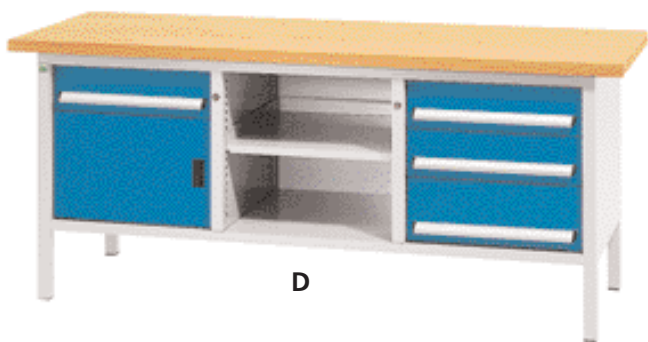

D

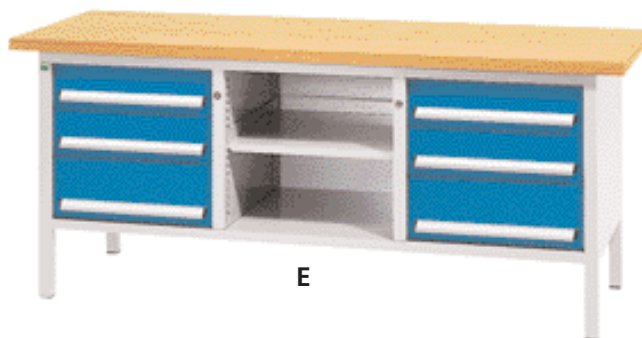

E

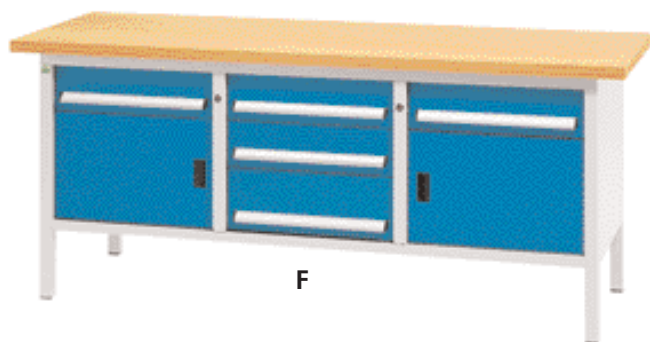

F

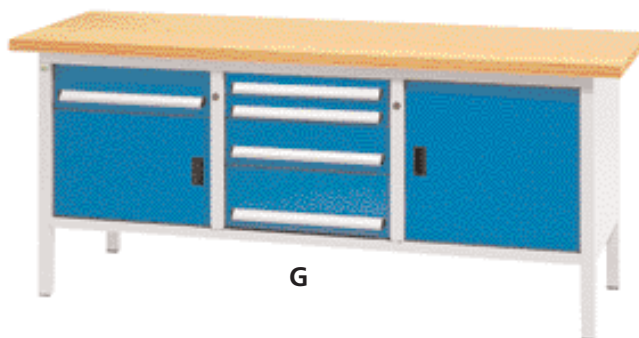

G

| Fig.  | Description       | Dimensions<br>W x D x H mm | Worktop   | Part ref.     | Price £ |
|---|-------------------|----------------------------|-----------|---------------|---------|
| D   | KWBM 40 2070M-5.3 | 2000 x 700 x 840           | Multiplex | 110 16 115.03 | 784.54  |
|   | KWBL 40 2070M-5.3 | 2000 x 700 x 840           | Linoleum  | 110 16 199.03 | 864.82  |
| 1 x Door 350 mm, 3 x Drawer 150 mm, 1 x Drawer 200 mm, incl. 1 Shelf                                    |                   |                            |           |               |         |
| E   | KWBM 40 2070M-6.1 | 2000 x 700 x 840           | Multiplex | 110 11 033.03 | 848.79  |
|   | KWBL 40 2070M-6.1 | 2000 x 700 x 840           | Linoleum  | 110 11 051.03 | 929.08  |
| 4 x Drawer 150 mm, 2 x Drawer 200 mm, incl. 1 Shelf   |                   |                            |           |               |         |
| F   | KWBM 40 2070M-7.1 | 2000 x 700 x 840           | Multiplex | 110 16 119.03 | 847.59  |
|   | KWBL 40 2070M-7.1 | 2000 x 700 x 840           | Linoleum  | 110 16 201.03 | 864.59  |
| 2 x Door 350 mm, 4 x Drawer 150 mm, 1 x Drawer 200 mm   |                   |                            |           |               |         |
| G   | KWBM 40 2070M-7.2 | 2000 x 700 x 840           | Multiplex | 110 16 121.03 | 861.67  |
|   | KWBL 40 2070M-7.2 | 2000 x 700 x 840           | Linoleum  | 110 16 202.03 | 941.96  |
| 1 x Door 350 mm, 1 x Door 500 mm, 2 x Drawer 75 mm, 2 x Drawer 150 mm, 1 x Drawer 200 mm, incl. 1 Shelf |                   |                            |           |               |         |

## Standard paint finish

|          |                     |
|----------|---------------------|
| Housing: | RAL 7035 light grey |
| Fronts:  | RAL 5015 blue .03   |

## Alternative front colours (no extra charge)

|                         |                     |                     |                     |                     |
|-------------------------|---------------------|---------------------|---------------------|---------------------|
| RAL 7035 light grey     | RAL 7035 light grey | RAL 7035 light grey | RAL 7035 light grey | RAL 7035 light grey |
| RAL 7035 light grey .16 | RAL 7001 grey .01   | RAL 6011 green .02  | RAL 3001 red .04    | RAL 1023 yellow .12 |

(Please replace the order ref. suffix from .03 to that for your required colour)

Drawer Cabinets

Workbenches

Workstation Systems APS

Mobile Equipment

Storage Cupboards

Combination Drawer & Shelving System

Drawer Dividers

Perfo® System

CNC System

Cases

# Modular workbenches KWB



Dimensions: Width 2000 x Depth 700 x Height 840 mm

- Suitable for heavy assembly work
- Load capacity 600-1200 kg depending on worktop version
- Sturdy steel base frame
- Choose from 2 worktop finishes (Thickness 40 mm)
- Modular system that can be expanded as required.
- Load capacity per drawer 100 kg – Normal slide
- Drawer pan internal measurements W 520 x D 520 mm
- Drawer divider systems see page 210-225
- Central locking mechanism for doors and drawers
- Delivered assembled
- 230 mm floor clearance
- Recessed base frame for extra legroom

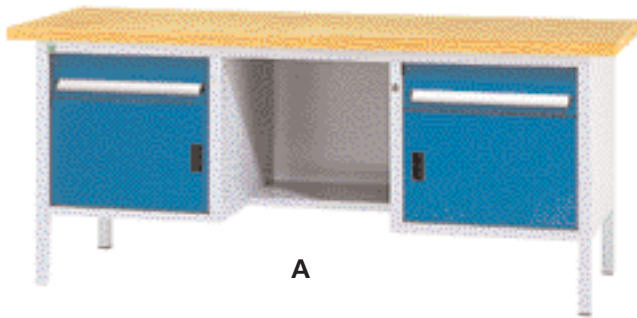

A

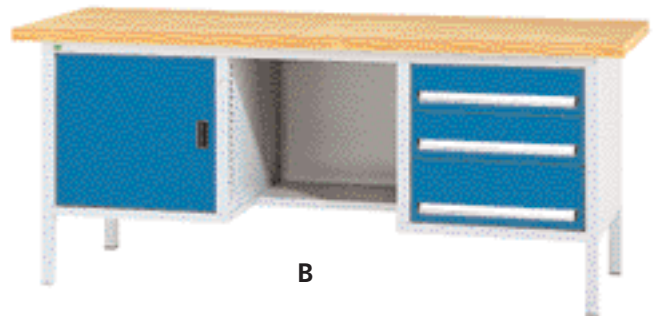

B

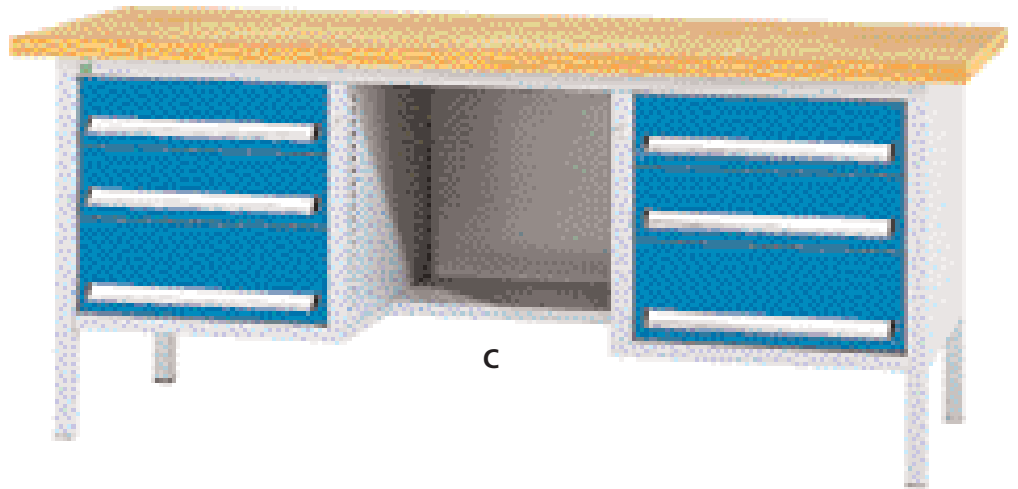

C

| Fig.   | Description        | Dimensions<br>W x D x H mm | Worktop   | Part ref.     | Price £ |
|--|--------------------|----------------------------|-----------|---------------|---------|
| A  | KWBM 40 2070AM-4.1 | 2000 x 700 x 840           | Multiplex | 110 16 125.03 | 728.62  |
|  | KWBL 40 2070AM-4.1 | 2000 x 700 x 840           | Linoleum  | 110 16 203.03 | 745.62  |
| 2 x Door 350 mm, 2 x Drawer 150 mm                                   |                    |                            |           |               |         |
| B  | KWBM 40 2070AM-4.3 | 2000 x 700 x 840           | Multiplex | 110 16 127.03 | 765.56  |
|  | KWBL 40 2070AM-4.3 | 2000 x 700 x 840           | Linoleum  | 110 16 204.03 | 782.56  |
| 1 x Door 500 mm, incl. 1 Shelf, 2 x Drawer 150 mm, 1 x Drawer 200 mm |                    |                            |           |               |         |
| C  | KWBM 40 2070AM-6.1 | 2000 x 700 x 840           | Multiplex | 110 11 035.03 | 854.32  |
|  | KWBL 40 2070AM-6.1 | 2000 x 700 x 840           | Linoleum  | 110 11 052.03 | 871.32  |
| 4 x Drawer 150 mm, 2 x Drawer 200 mm                                 |                    |                            |           |               |         |

## Standard paint finish

|          |                     |
|----------|---------------------|
| Housing: | RAL 7035 light grey |
| Fronts:  | RAL 5015 blue .03   |

## Alternative front colours (no extra charge)

|                         |                     |                     |                     |                     |
|-------------------------|---------------------|---------------------|---------------------|---------------------|
| RAL 7035 light grey     | RAL 7035 light grey | RAL 7035 light grey | RAL 7035 light grey | RAL 7035 light grey |
| RAL 7035 light grey .16 | RAL 7001 grey .01   | RAL 6011 green .02  | RAL 3001 red .04    | RAL 1023 yellow .12 |

(Please replace the order ref. suffix from .03 to that for your required colour)

# Modular workbenches KWB

Dimensions: Width 2000 x Depth 700 x Height 840 mm

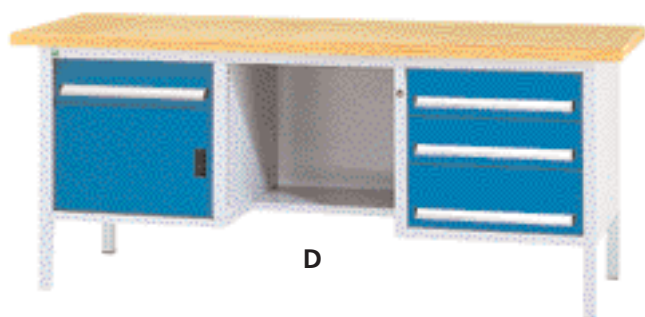

D

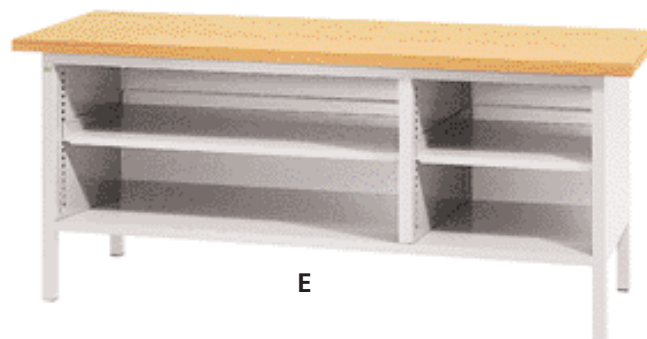

E

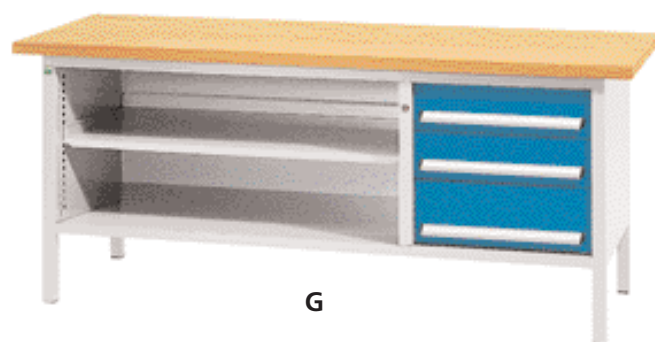

G

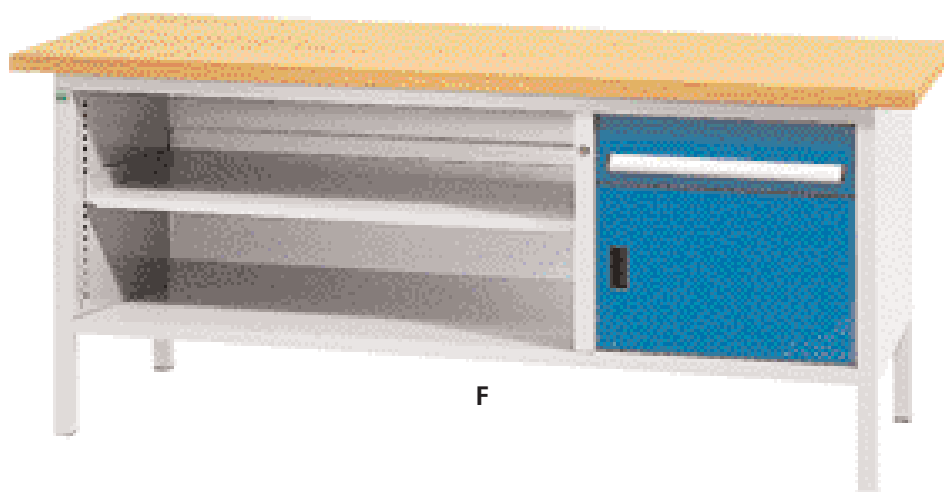

F

Drawer Cabinets

Workbenches

Workstation Systems APS

Mobile Equipment

Storage Cupboards

Combination Drawer & Shelving System

Drawer Dividers

Perfo® System

CNC System

Cases

| Fig.   | Description       | Dimensions<br>W x D x H mm | Worktop   | Part ref.     | Price £ |
|--|-------------------|----------------------------|-----------|---------------|---------|
| <b>D</b>   | KWB 40 2070AM-5.1 | 2000 x 700 x 840           | Multiplex | 110 16 129.03 | 808.45  |
|  |                   |                            | Linoleum  | 110 16 205.03 | 888.74  |
| 1 x Door 350 mm, 3 x Drawer 150 mm, 1 x Drawer 200 mm    |                   |                            |           |               |         |
| <b>E</b>   | KWB 40 2070DM-0.1 | 2000 x 700 x 840           | Multiplex | 110 03 073.16 | 589.04  |
|  |                   |                            | Linoleum  | 110 03 086.16 | 669.32  |
| incl. 1 Shelf long, incl. 1 Shelf short                  |                   |                            |           |               |         |
| <b>F</b>   | KWB 40 2070DM-2.1 | 2000 x 700 x 840           | Multiplex | 110 16 086.03 | 650.89  |
|  |                   |                            | Linoleum  | 110 16 206.03 | 667.89  |
| 1 x Door 350 mm, 1 x Drawer 150 mm, incl. 1 Shelf long   |                   |                            |           |               |         |
| <b>G</b>   | KWB 40 2070DM-3.1 | 2000 x 700 x 840           | Multiplex | 110 09 067.03 | 713.51  |
|  |                   |                            | Linoleum  | 110 09 074.03 | 793.80  |
| 2 x Drawer 150 mm, 1 x Drawer 200 mm, incl. 1 Shelf long |                   |                            |           |               |         |

## Standard paint finish

|          |                     |
|----------|---------------------|
| Housing: | RAL 7035 light grey |
| Fronts:  | RAL 5015 blue .03   |

## Alternative front colours (no extra charge)

|                     |                     |                     |                     |                     |
|---------------------|---------------------|---------------------|---------------------|---------------------|
| RAL 7035 light grey | RAL 7035 light grey | RAL 7035 light grey | RAL 7035 light grey | RAL 7035 light grey |
| RAL 6011 green .02  | RAL 3001 red .04    | RAL 1023 yellow .12 |                     |                     |

(Please replace the order ref. suffix from .03 to that for your required colour)



Base frame 0770



Layout possibility



Base frame 1570



Layout possibility



Base frame 1570A



Layout possibility



Base frame 1570AL

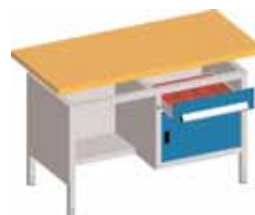

Layout possibility

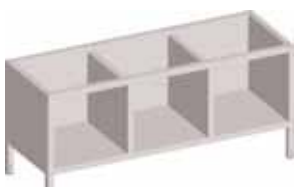

Base frame 2070



Layout possibility

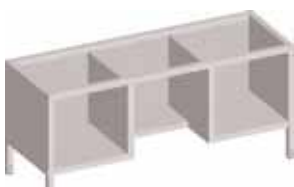

Base frame 2070A

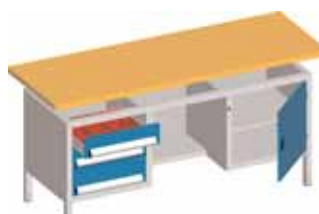

Layout possibility

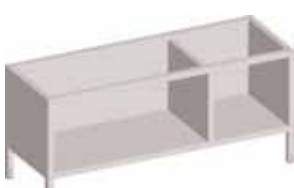

Base frame 2070D

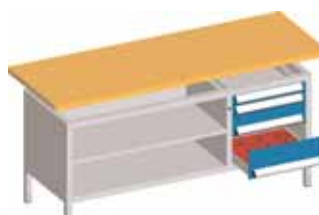

Layout possibility

**Description:**

The single worktable components can be combined to form your own custom bench.

Modular workbenches are supplied fully assembled

**Following individual components are available:**

• **Worktops**

9 different worktop types  
in 3 different thicknesses

• **Base frame**

Basic KWB frames include 1, 2 or 3 modules with a usable height of 500 mm each. Central locking mechanisms can be specified with the following components. Basic frames 1570A, 1570AL and 2070A have a half depth shelf on the right hand, left hand or central position to provide a knee-hole.

• **Individual drawers available in six different front heights**

Ball-bearing drawers with aluminium handles including paper strips and transparent cover for drawer labelling. Internal dimensions W 520 x D 520 mm  
NS-Normal slide  
- Load capacity: 100 kg  
- Slide: 93%

• **Cabinet doors in 2 heights**

With integral handle  
(not to be used for the middle block)

• **Shelf**

With 3-sided safety lip.  
Adjustable in 25 mm increments

• **Height adjustment**

All versions can be specified with a height adjustment kit.

• **Mobile version**

All versions can be specified with a mobility kit.

| Description                   | Delivery               | Usable height mm | Dimensions W x D x H mm | Part ref.     | Price £ |
|-------------------------------|------------------------|------------------|-------------------------|---------------|---------|
| Base frame 0770               | assembled <sup>1</sup> | 1 x 500          | 675 x 635 x 800         | 119 03 153.16 | 314.69  |
| Base frame 1570               | assembled <sup>1</sup> | 2 x 500          | 1225 x 635 x 800        | 119 03 097.16 | 331.37  |
| Base frame 1570A              | assembled <sup>1</sup> | 2 x 500          | 1225 x 635 x 800        | 119 03 120.16 | 339.21  |
| Base frame 1570AL             | assembled <sup>1</sup> | 2 x 500          | 1225 x 635 x 800        | 119 03 174.16 | 316.10  |
| Base frame 2070 <sup>2</sup>  | assembled <sup>1</sup> | 3 x 500          | 1825 x 635 x 800        | 119 03 098.16 | 387.75  |
| Base frame 2070A <sup>2</sup> | assembled <sup>1</sup> | 3 x 500          | 1825 x 635 x 800        | 119 03 099.16 | 410.49  |
| Base frame 2070D              | assembled <sup>1</sup> | 1 x 500          | 1825 x 635 x 800        | 119 03 118.16 | 377.00  |

<sup>1</sup> Please always specify on your order how the drawers should be arranged from top to bottom.

<sup>2</sup> Please note: The base frame 2070 and 2070A cannot be fitted with cabinet doors in the centre module.

| Description                    | Dimensions W x D x H mm | Part ref.     | Price £ |
|--------------------------------|-------------------------|---------------|---------|
| Worktop Beech multiplex, 40 mm | 750 x 700 x 40          | 112 01 266.08 | 52.75   |
| Worktop Beech multiplex, 40 mm | 1500 x 700 x 40         | 112 01 003.08 | 101.00  |
| Worktop Beech multiplex, 40 mm | 2000 x 700 x 40         | 112 01 006.08 | 139.00  |
| Worktop Linoleum, 40 mm        | 750 x 700 x 40          | 112 01 266.15 | 103.23  |
| Worktop Linoleum, 40 mm        | 1500 x 700 x 40         | 112 01 003.15 | 124.00  |
| Worktop Linoleum, 40 mm        | 2000 x 700 x 40         | 112 01 006.15 | 156.00  |

further worktops – see page 100-104

| Description                 | Front height mm | Dimensions internal W x D mm | Part ref.     | Price £ |
|-----------------------------|-----------------|------------------------------|---------------|---------|
| Single drawer <sup>1</sup>  | 75              | 520 x 520                    | 105 05 112.03 | 41.03   |
| Single drawer <sup>1</sup>  | 100             | 520 x 520                    | 105 05 113.03 | 43.98   |
| Single drawer <sup>1</sup>  | 125             | 520 x 520                    | 105 05 114.03 | 44.37   |
| Single drawer <sup>1</sup>  | 150             | 520 x 520                    | 105 05 115.03 | 44.69   |
| Single drawer <sup>1</sup>  | 175             | 520 x 520                    | 105 05 116.03 | 45.94   |
| Single drawer <sup>1</sup>  | 200             | 520 x 520                    | 105 05 117.03 | 46.89   |
| Hinged doors <sup>1,2</sup> | 350             |                              | 125 01 153.03 | 23.79   |
| Hinged doors <sup>1,2</sup> | 500             |                              | 125 01 154.03 | 25.28   |
| Shelf                       | 50              | 555 x 590 x 50               | 121 01 161.16 | 15.44   |
| Basic rack shelf 2070 D     | 50              | 1150 x 590 x 50              | 121 03 030.16 | 31.10   |

<sup>1</sup> Please note that the combined sum of the front heights may not exceed the usable height of the individual blocks.

<sup>2</sup> Please note: the centre module in base frames 2070 and 2070A cannot be fitted with cabinet doors.

Drawer dividers – see page 210-225.

## KWB accessories



»Height adjustment kit« (cannot be used in combination with the mobility kit) (4 pieces), adjustable area 0-150 mm in 50 mm increments or infinitely variable. Height adjustable from 800 to 950 mm (without panel). Retrofit kit can be used to adjust bench to uneven floor conditions.

| Part ref.     | Price £ |
|---------------|---------|
| 080 30 462.16 | 23.13   |



»Mobility kit« (cannot be used in combination with the height adjustment kit) (4 pieces), 4 Swivel castors Ø 100 mm, 2 castors having locking brakes. Height 120 mm

| Part ref.  | Price £ |
|------------|---------|
| 809 06 008 | 64.02   |

### Standard paint finish

|          |                     |
|----------|---------------------|
| Housing: | RAL 7035 light grey |
| Fronts:  | RAL 5015 blue .03   |

### Alternative front colours (no extra charge)

|                         |                     |                     |                     |                     |
|-------------------------|---------------------|---------------------|---------------------|---------------------|
| RAL 7035 light grey     | RAL 7035 light grey | RAL 7035 light grey | RAL 7035 light grey | RAL 7035 light grey |
| RAL 7035 light grey .16 | RAL 7001 grey .01   | RAL 6011 green .02  | RAL 3001 red .04    | RAL 1023 yellow .12 |

(Please replace the order ref. suffix from .03 to that for your required colour)



Drawer Cabinets

Workbenches

Workstation Systems APS

Mobile Equipment

Storage Cupboards

Combination Drawer & Shelving System

Drawer Dividers

Perfo® System

CNC System

Cases

## Beech multiplex worktop

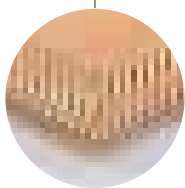
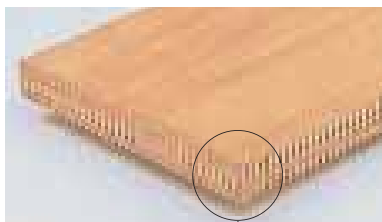

Max. dimensions: 2500 x 1500 mm\*

| Special size*   | Part ref.     | Price                   |
|-----------------|---------------|-------------------------|
| Thickness 30 mm | 112 01 066.08 | 97.61 £/m <sup>2</sup>  |
| Thickness 40 mm | 112 01 049.08 | 205.75 £/m <sup>2</sup> |
| Thickness 50 mm | 112 01 048.08 | 134.33 £/m <sup>2</sup> |

Material: Laminated bi-directionally bonded beech veneer  
 Top surface: Oiled  
 Bottom side: Oiled  
 Colour: Natural beech  
 Bonding: IW 67  
 Quality: II / III according to DIN 68705 Part 2

| Dimensions W x D x H mm | Part ref.     | Price £ |
|-------------------------|---------------|---------|
| 1500 x 700 x 30         | 112 01 114.08 | 96.00   |
| 2000 x 700 x 30         | 112 01 118.08 | 133.00  |
| 750 x 700 x 40          | 112 01 266.08 | 52.75   |
| 1500 x 700 x 40         | 112 01 003.08 | 101.00  |
| 2000 x 700 x 40         | 112 01 006.08 | 139.00  |
| 1500 x 700 x 50         | 112 01 002.08 | 139.26  |
| 2000 x 700 x 50         | 112 01 005.08 | 200.47  |
| 1500 x 900 x 30         | 112 01 082.08 | 101.00  |
| 2000 x 900 x 30         | 112 01 083.08 | 139.00  |
| 1500 x 900 x 40         | 112 01 148.08 | 122.00  |
| 2000 x 900 x 40         | 112 01 149.08 | 167.00  |

## Beech worktop

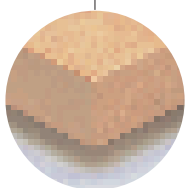
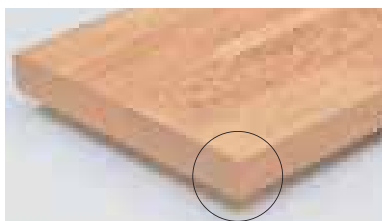

Max. dimensions: 3000 x 1200 mm\*

| Special size*   | Part ref.     | Price                   |
|-----------------|---------------|-------------------------|
| Thickness 30 mm | 112 01 066.07 | 153.45 £/m <sup>2</sup> |
| Thickness 40 mm | 112 01 049.07 | 156.20 £/m <sup>2</sup> |
| Thickness 50 mm | 112 01 048.07 | 190.03 £/m <sup>2</sup> |

Material: Solid beech, spliced joints  
 Top surface: 2 x DD painted  
 Bottom side: 1 x DD painted  
 Colour: Natural beech  
 Data: Abrasion and acid resistant surface, spliced joints, with a high load bearing capacity

| Dimensions W x D x H mm | Part ref.     | Price £ |
|-------------------------|---------------|---------|
| 1500 x 700 x 30         | 112 01 114.07 | 148.94  |
| 2000 x 700 x 30         | 112 01 118.07 | 183.19  |
| 750 x 700 x 40          | 112 01 266.07 | 71.91   |
| 1500 x 700 x 40         | 112 01 003.07 | 141.27  |
| 2000 x 700 x 40         | 112 01 006.07 | 183.19  |
| 1500 x 700 x 50         | 112 01 002.07 | 188.47  |
| 2000 x 700 x 50         | 112 01 005.07 | 260.87  |
| 1500 x 900 x 30         | 112 01 082.07 | 206.01  |
| 2000 x 900 x 30         | 112 01 083.07 | 272.67  |
| 1500 x 900 x 40         | 112 01 148.07 | 268.54  |
| 2000 x 900 x 40         | 112 01 149.07 | 343.64  |

## Universal worktop

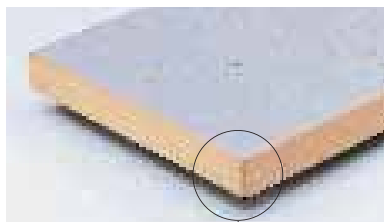

Max. dimensions: 3000 x 1200 mm\*

| Special size*   | Part ref.     | Price                   |
|-----------------|---------------|-------------------------|
| Thickness 30 mm | 112 01 066.13 | 156.40 £/m <sup>2</sup> |
| Thickness 40 mm | 112 01 049.13 | 203.60 £/m <sup>2</sup> |
| Thickness 50 mm | 112 01 048.13 | 189.24 £/m <sup>2</sup> |

Material: 30 mm thick with chipboard core,  
40 mm thick with hardwood core

Top surface: Linoleum 2mm (antistatic)

Bottom side: HPL laminate surface layer

Edges: 3 mm thick solid beech edges with rounded radius R3

Colour: Light grey

Data: Linoleum laminate in accordance with EN 548,  
permanently antistatic, virtually inflammable (B1) in accordance  
with DIN 4102, hard wearing and resistant to temperature,  
resistant to oil, grease and tar, partially resistant to weak acids  
and solvents, biodegradable

Insert: For work with high abrasion levels resistant to weak acids and alkalis

| Dimensions W x D x H mm | Part ref.     | Price £ |
|-------------------------|---------------|---------|
| 1500 x 700 x 30         | 112 01 114.13 | 169.20  |
| 2000 x 700 x 30         | 112 01 118.13 | 194.79  |
| 750 x 700 x 40          | 112 01 266.13 | 105.73  |
| 1500 x 700 x 40         | 112 01 003.13 | 193.78  |
| 2000 x 700 x 40         | 112 01 006.13 | 228.03  |
| 1500 x 700 x 50         | 112 01 002.13 | 204.60  |
| 2000 x 700 x 50         | 112 01 005.13 | 243.96  |
| 1500 x 900 x 30         | 112 01 082.13 | 285.31  |
| 2000 x 900 x 30         | 112 01 083.13 | 332.15  |
| 1500 x 900 x 40         | 112 01 148.13 | 300.73  |
| 2000 x 900 x 40         | 112 01 149.13 | 351.98  |

## Linoleum worktop

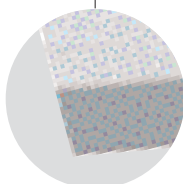
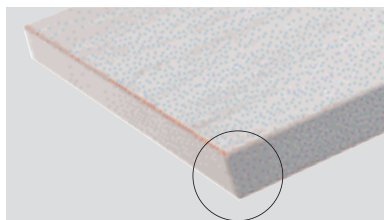

Material: 30/40 mm thick with chipboard core

Top surface: Linoleum

Edges: Plastic edging

Colour: Grey

Data: Resistant to oil and grease

| Dimensions W x D x H mm | Part ref.     | Price £ |
|-------------------------|---------------|---------|
| 1500 x 700 x 30         | 112 01 114.15 | 117.00  |
| 2000 x 700 x 30         | 112 01 118.15 | 143.00  |
| 750 x 700 x 40          | 112 01 266.15 | 103.23  |
| 1500 x 700 x 40         | 112 01 003.15 | 124.00  |
| 2000 x 700 x 40         | 112 01 006.15 | 156.00  |
| 1500 x 900 x 30         | 112 01 082.15 | 125.00  |
| 2000 x 900 x 30         | 112 01 083.15 | 187.00  |
| 1500 x 900 x 40         | 112 01 148.15 | 132.00  |
| 2000 x 900 x 40         | 112 01 149.15 | 196.00  |

## Accessories

only available in combination with custom made worktops



**'U' profile steel edge protection (front)**  
Protects worktop edge in harsh applications.  
Part ref.: 080 03 245  
Price: 26.95 £ (per metre)



**Worktop-worktop connector**  
For invisible worktop joints in multi bench configurations  
Part ref.: 126 35 003  
Price: 19.67 £ (per item)  
(Illustration shows two pieces)

\* Special size for special packaging:

Please note that additional/special packaging is required for special sizes, width >2000 mm, depth >800 mm

Part ref.: 820 02 009 Price: 34.12 £

Drawer  
Cabinets

Workbenches

Workstation  
Systems APS

Mobile  
Equipment

Storage  
Cupboards

Combination  
Drawer  
& Shelving System

Drawer  
Dividers

Perfo® System

CNC System

Cases

## Arphenol worktop

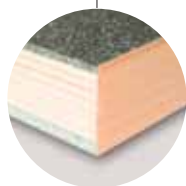
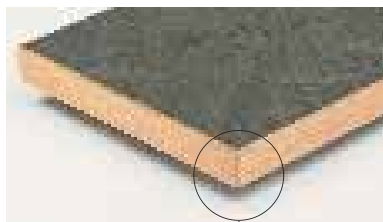

Max. dimensions: 2500 x 1200 mm\*

| Special size*   | Part ref.     | Price                     |
|-----------------|---------------|---------------------------|
| Thickness 30 mm | 112 01 066.10 | 183.93 £/m <sup>2</sup> * |
| Thickness 40 mm | 112 01 049.10 | 190.74 £/m <sup>2</sup> * |
| Thickness 50 mm | 112 01 048.10 | 318.46 £/m <sup>2</sup> * |

\* Dimensions < 0.5m<sup>2</sup> by special request

Material: Hardwood core with 4mm Arphenol surface and laminate hardwood edging.  
 Top surface: Painted (UV lacquer)  
 Bottom side: 6 mm chipboard surface layer  
 Colour: Grey brown  
 Data: Surface resistant to chemicals in accordance with DIN 68 861-18.

| Dimensions W x D x H mm | Part ref.     | Price £ |
|-------------------------|---------------|---------|
| 1500 x 700 x 30         | 112 01 114.10 | 202.39  |
| 2000 x 700 x 30         | 112 01 118.10 | 269.92  |
| 750 x 700 x 40          | 112 01 266.10 | 121.92  |
| 1500 x 700 x 40         | 112 01 003.10 | 183.85  |
| 2000 x 700 x 40         | 112 01 006.10 | 238.55  |
| 1500 x 700 x 50         | 112 01 002.10 | 186.70  |
| 2000 x 700 x 50         | 112 01 005.10 | 242.19  |
| 1500 x 900 x 30         | 112 01 082.10 | 291.92  |
| 2000 x 900 x 30         | 112 01 083.10 | 393.83  |
| 1500 x 900 x 40         | 112 01 148.10 | 297.43  |
| 2000 x 900 x 40         | 112 01 149.10 | 401.54  |

## Hard laminate ESD safe worktop for electrostatically sensitive components

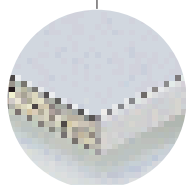
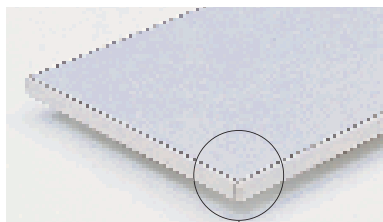

Max. dimensions: 3000 x 1200 mm\*

| Special size*   | Part ref.     | Price                   |
|-----------------|---------------|-------------------------|
| Thickness 30 mm | 112 01 066.05 | 235.07 £/m <sup>2</sup> |
| Thickness 40 mm | 112 01 049.05 | 255.33 £/m <sup>2</sup> |
| Thickness 50 mm | 112 01 048.05 | 288.53 £/m <sup>2</sup> |

Material: Conductive chipboard  
 Top surface: Conductive HPL laminated surface 0.8 mm  
 Bottom side: HPL laminate surface layer  
 Edges: 3 mm thick ABS edges, antistatic, rounded radius R3  
 Colour: Light grey  
 Data: HPL laminate surface in accordance with DIN EN 438, maximum abrasion resistance, maximum impact and scratch resistance, resistant to boiling water and household chemicals, solvents, weak acids and alkalis  
 Leakage values: In accordance with DIN EN 100 015 and EN 61340

| Dimensions W x D x H mm | Part ref.     | Price £ |
|-------------------------|---------------|---------|
| 1500 x 700 x 30         | 112 01 114.05 | 197.19  |
| 2000 x 700 x 30         | 112 01 118.05 | 215.68  |
| 750 x 700 x 40          | 112 01 266.05 | 129.93  |
| 1500 x 700 x 40         | 112 01 003.05 | 229.64  |
| 2000 x 700 x 40         | 112 01 006.05 | 282.90  |
| 1500 x 700 x 50         | 112 01 002.05 | 301.95  |
| 2000 x 700 x 50         | 112 01 005.05 | 346.82  |
| 1500 x 900 x 30         | 112 01 082.05 | 291.92  |
| 2000 x 900 x 30         | 112 01 083.05 | 358.58  |
| 1500 x 900 x 40         | 112 01 148.05 | 318.36  |
| 2000 x 900 x 40         | 112 01 149.05 | 389.42  |

## Worktop with zinc-finished steel cladding

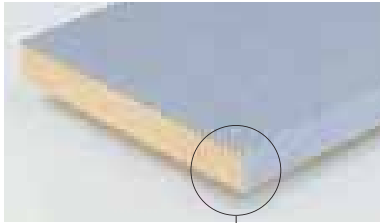

Material:  
Top surface:  
Bottom side:  
Edges:

Chipboard  
Zinc coated sheet steel 2 mm  
HPL laminate surface layer  
Veneered edge  
Front edge: sheet steel 'U' profile edging  
Rear edge: sheet steel 'L' profile edging

Available thicknesses:  
Colour:  
Data:

Zinc plated  
Sheet steel, hot-dip galvanized, in accordance with EN 10142, tested to EN 10204

Max. dimensions: 3000 x 1200 mm\*

| Special size*   | Part ref.     | Price                   |
|-----------------|---------------|-------------------------|
| Thickness 30 mm | 112 01 066.14 | 248.84 £/m <sup>2</sup> |
| Thickness 40 mm | 112 01 049.14 | 248.84 £/m <sup>2</sup> |
| Thickness 50 mm | 112 01 048.14 | 254.74 £/m <sup>2</sup> |

| Dimensions W x D x H mm | Part ref.     | Price £ |
|-------------------------|---------------|---------|
| 1500 x 700 x 30         | 112 01 114.14 | 230.17  |
| 2000 x 700 x 30         | 112 01 118.14 | 297.06  |
| 750 x 700 x 40          | 112 01 266.14 | 119.78  |
| 1500 x 700 x 40         | 112 01 003.14 | 230.17  |
| 2000 x 700 x 40         | 112 01 006.14 | 297.06  |
| 1500 x 700 x 50         | 112 01 002.14 | 240.00  |
| 2000 x 700 x 50         | 112 01 005.14 | 310.83  |
| 1500 x 900 x 30         | 112 01 082.14 | 397.80  |
| 2000 x 900 x 30         | 112 01 083.14 | 362.99  |
| 1500 x 900 x 40         | 112 01 148.14 | 397.80  |
| 2000 x 900 x 40         | 112 01 149.14 | 362.99  |

## Accessories only available in combination with custom made worktops



### 'U' profile steel edge protection (front)

Protects worktop edge in harsh applications.  
Part ref.: 080 03 245  
Price: 26.95 £ (per metre)



### Worktop-worktop connector

For invisible worktop joints in multi bench configurations  
Part ref.: 126 35 003  
Price: 19.67 £ (per item)  
(Illustration shows two pieces)

\* Special size for special packaging:

Please note that additional/special packaging is required for special sizes, width >2000 mm, depth >800 mm  
Part ref.: 820 02 009 Price: 34.12 £



Drawer  
Cabinets

Workbenches

Workstation  
Systems APS

Mobile  
Equipment

Storage  
Cupboards

Combination Drawer  
& Shelving System

Drawer  
Dividers

Perfo® System

CNC System

Cases

| Fig. | Description                          | Worktop   | Part ref.     | Price £ |
|------|--------------------------------------|-----------|---------------|---------|
| A    | Corner worktop – Type »L«            | Multiplex | 112 04 031.08 | 112.21  |
| B    | Corner worktop – Type »L«            | Linoleum  | 112 04 031.15 | 222.00  |
| C    | Corner worktop – Type »T«            | Multiplex | 112 04 032.08 | 168.36  |
| D    | Corner worktop – Type »T«            | Linoleum  | 112 04 032.15 | 320.56  |
| E    | Wall support bracket 500 x 75 mm     |           | 112 04 025.16 | 7.25    |
| F    | Wall support bracket 750 x 75 mm     |           | 112 04 026.16 | 10.25   |
| G    | Worktop joining plate – 250 x 100 mm |           | 112 04 021.16 | 3.95    |
| H    | Worktop joining plate – 250 x 200 mm |           | 112 04 022.16 | 6.45    |
| I    | Worktop joining plate – 500 x 100 mm |           | 112 04 023.16 | 6.45    |
| J    | Worktop joining plate – 500 x 200 mm |           | 112 04 024.16 | 11.40   |

Material thickness: 40 mm

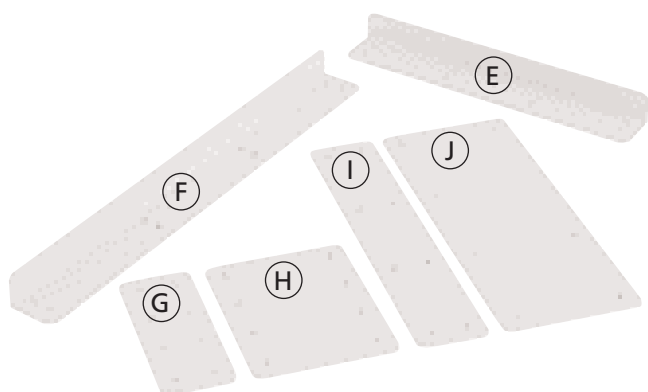
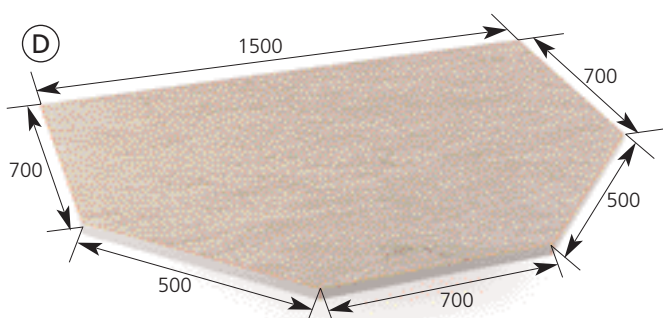
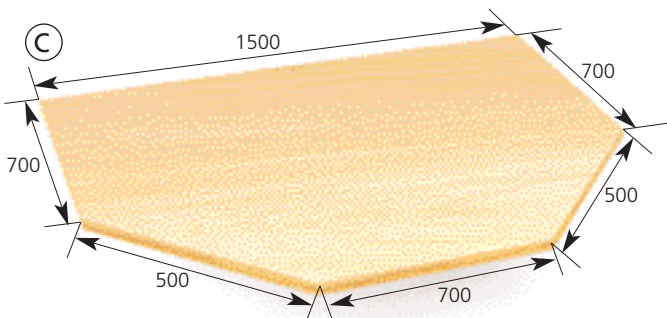
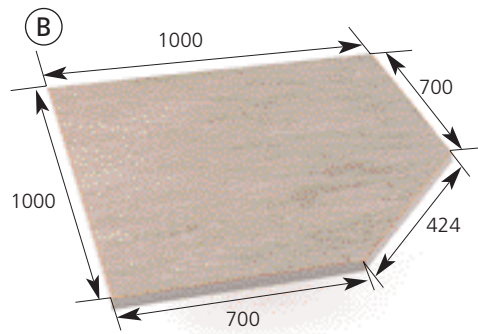
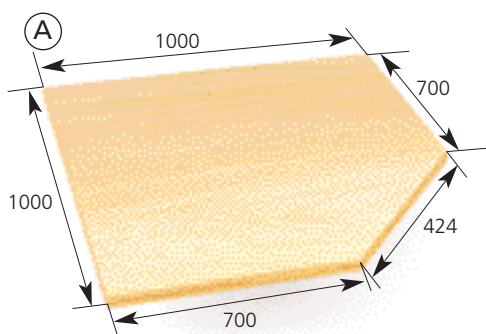

## Beech multiplex worktop upstand

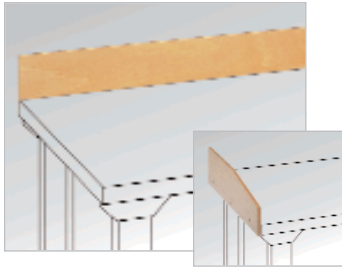

| Description | Dimensions<br>W x D x H mm | Part ref.  | Price £ |
|-------------|----------------------------|------------|---------|
| rear        | 750 x 15 x 150             | 112 03 052 | 22.24   |
| rear        | 1500 x 15 x 150            | 112 03 001 | 30.58   |
| rear        | 2000 x 15 x 150            | 112 03 002 | 36.04   |
| Side        | 15 x 700 x 150             | 112 03 003 | 23.18   |
| Side        | 15 x 900 x 150             | 112 03 056 | 23.18   |

## Metal worktop upstand set



for workbenches – Width 1500 / 2000 x Depth 700 mm

| Description         | Dimensions<br>W x H mm | Part ref.     | Price £ |
|---------------------|------------------------|---------------|---------|
| Worktop upstand set | 1500 x 100             | 119 03 108.16 | 35.00   |
| Worktop upstand set | 2000 x 100             | 119 03 109.16 | 47.20   |

## Adjustable shelf

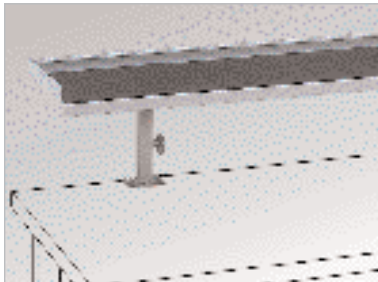

Height adjustable, with ribbed rubber mat

| for worktable<br>Width mm | Dimensions<br>W x D x H mm | Part ref.     | Price £ |
|---------------------------|----------------------------|---------------|---------|
| 1500                      | 1500 x 300 x 230-345       | 121 15 003.16 | 113.28  |
| 2000                      | 2000 x 300 x 230-345       | 121 15 004.16 | 130.80  |

Drawer  
Cabinets

Workbenches

Workstation  
Systems APS

Mobile  
Equipment

Storage  
Cupboards

Combination Drawer  
& Shelving System

Drawer  
Dividers

Perfo® System

CNC System

Cases

## Perfo® back panel

Height 457 mm, also suitable for wall mounting

(Accessories for perforated panels – see page 232-239, Accessories for louvred panels – see page 253 and 270)

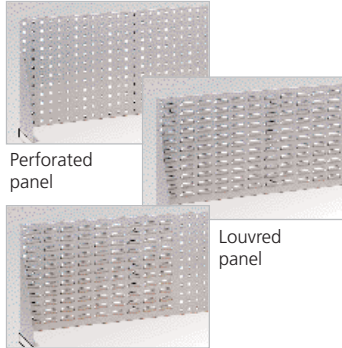

Perforated panel

Louvred panel

Combination panel

| Description                            | Dimensions<br>W x H mm | Part ref.     | Price £ |
|--|------------------------|---------------|---------|
| Perfo® perforated panel <sup>1)</sup>  | 1486 x 457             | 140 25 118.16 | 45.27   |
| Perfo® perforated panel <sup>1)</sup>  | 1981 x 457             | 140 25 119.16 | 57.68   |
| Perfo® louvred panel <sup>1)</sup>     | 1486 x 457             | 140 25 140.16 | 45.27   |
| Perfo® louvred panel <sup>1)</sup>     | 1981 x 457             | 140 25 141.16 | 57.68   |
| Perfo® combination panel <sup>1)</sup> | 1486 x 457             | 140 25 156.16 | 45.27   |
| Perfo® combination panel <sup>1)</sup> | 1981 x 457             | 140 25 157.16 | 57.68   |

<sup>1)</sup> Please order wing plates and brackets separately for fixing to workbenches.

## Perfo® - Wing plates for workbench mounting

for mounting the Perfo® back panel to a workbench

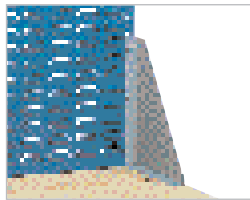

|        | Part ref.     | Price £ |
|--------|---------------|---------|
| 1 pair | 080 10 067.16 | 15.02   |

## Perfo® - Bracket for workbench mounting

For mounting the Perfo® back panel to a workbench.

The following quantity of brackets will be required: W 1486 mm = 4 piece, W 1981 = 5 piece

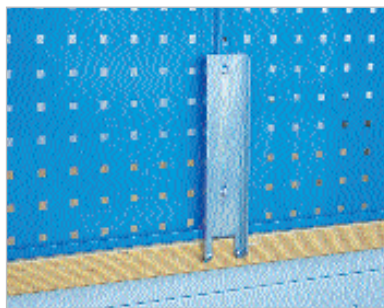

|  | Part ref.  | Price £ |
|--|------------|---------|
| for the mounting of single panels              | 080 30 050 | 2.91    |
| for the mounting of 2 panels one above another | 080 30 048 | 5.86    |



## Power duct

Connecting cable with plug / On / Off Switch

| Version | Main switch | Dimensions<br>W x D x H mm | Quantity<br>plug | Part ref.  | Price £ |
|---------|-------------|----------------------------|------------------|------------|---------|
| EU      | No          | 300 x 45 x 60              | 3                | 510 01 024 | 54.38   |
| EU      | No          | 450 x 45 x 60              | 6                | 510 01 025 | 68.52   |
| EU      | Yes         | 400 x 45 x 60              | 3                | 510 01 026 | 145.11  |
| EU      | Yes         | 550 x 45 x 60              | 6                | 510 01 027 | 161.83  |
| UK      | No          | 300 x 45 x 60              | 3                | 510 01 045 | 65.38   |
| UK      | No          | 450 x 45 x 60              | 6                | 510 01 046 | 90.45   |
| UK      | Yes         | 400 x 45 x 60              | 3                | 510 01 047 | 144.58  |
| UK      | Yes         | 550 x 45 x 60              | 6                | 510 01 048 | 166.76  |

**\*For information on country-specific versions for other countries, please consult your local bott partner.**

## Perfo® back panels

incl. workbench wing plates and brackets

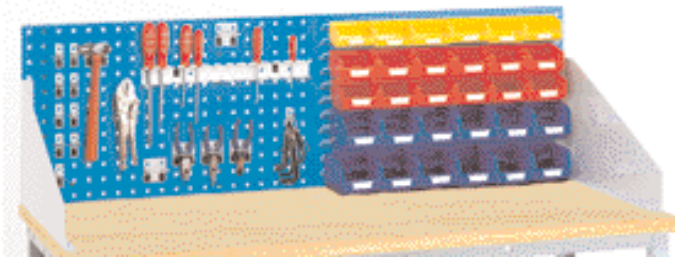

| Description                                | for workbench with width | Part ref.     | Price £ |
|--|--------------------------|---------------|---------|
| Perfo® back panel – with perforated panel  | 1500 mm                  | 070 02 043.03 | 50.00   |
| Perfo® back panel – with perforated panel  | 2000 mm                  | 070 02 044.03 | 65.00   |
| Perfo® back panel – with louvred panel     | 1500 mm                  | 070 02 045.03 | 50.00   |
| Perfo® back panel – with louvred panel     | 2000 mm                  | 070 02 046.03 | 65.00   |
| Perfo® back panel – with combination panel | 1500 mm                  | 070 02 054.03 | 50.00   |
| Perfo® back panel – with combination panel | 2000 mm                  | 070 02 055.03 | 65.00   |

| Description                        | for Perfo® panel                                     | Part ref.  | Price £ |
|------------------------------------|--|------------|---------|
| Perfo® hook assortment – 10 pieces | 1500 mm Combination panel                            | 140 31 410 | 7.50    |
| Perfo® hook assortment – 15 pieces | 1500 mm Perforated panel / 2000 mm Combination panel | 140 31 411 | 28.75   |
| Perfo® hook assortment – 20 pieces | 2000 mm Perforated panel                             | 140 31 412 | 33.00   |
| Perfo® plastic bins – 30 pieces    | 1500 mm Combination panel                            | 130 31 106 | 28.80   |
| Perfo® plastic bins – 45 pieces    | 2000 mm Combination panel                            | 130 31 092 | 43.20   |
| Perfo® plastic bins – 60 pieces    | 1500 mm Louvred panel                                | 130 31 167 | 57.60   |
| Perfo® plastic bins – 90 pieces    | 2000 mm Louvred panel                                | 130 31 105 | 95.40   |

### Standard paint finish

|          |                     |
|----------|---------------------|
| Housing: | RAL 7035 light grey |
| Fronts:  | RAL 5015 blue .03   |

### Alternative front colours (no extra charge)

|                         |                     |                     |                     |                     |
|-------------------------|---------------------|---------------------|---------------------|---------------------|
| RAL 7035 light grey     | RAL 7035 light grey | RAL 7035 light grey | RAL 7035 light grey | RAL 7035 light grey |
| RAL 7035 light grey .16 | RAL 7001 grey .01   | RAL 6011 green .02  | RAL 3001 red .04    | RAL 1023 yellow .12 |

(Please replace the order ref. suffix from .03 to that for your required colour)

Drawer  
Cabinets

Workbenches

Workstation  
Systems APS

Mobile  
Equipment

Storage  
Cupboards

Combination Drawer  
& Shelving System

Drawer  
Dividers

Perfo® System

CNC System

Cases





## Rear mounting frame

For mounting all APS® parts (Page 126-137)  
Double sided usage. Fits to the worktop.

| System size | Dimensions<br>W x D x H mm | Usable height<br>mm | Part ref.  | Price £ |
|-------------|----------------------------|---------------------|------------|---------|
| 815         | 855 x 70 x 1035            | 1000                | 120 15 010 | 86.29   |
| 1000        | 1040 x 70 x 1035           | 1000                | 120 15 011 | 88.06   |
| 1235        | 1275 x 70 x 1035           | 1000                | 120 15 012 | 89.44   |
| Fixing kit  |                            |                     | 900 99 123 | 6.41    |

for worktop thickness < 40 mm as well as chipboard core worktops



## Power supply (EU version)

Electrical accessories are also suitable for hexagonal services units and workbench leg F3.  
Please include an installation sketch with your order. Further installation components available on request.

**\*For information on country-specific versions for other countries, please consult your local bott partner.**



### Power duct

Delivered pre-wired  
PVC duct allows individual configuration  
of power accessories, H 130 x D 70 mm  
**L 1500** Part ref. 510 01 001 Price: £ 149.85  
**L 2000** Part ref. 510 01 002 Price: £ 151.30

### Connection cable 4 m

220 V Part ref. 508 10 008 Price: £ 54.34  
380 V Part ref. 508 10 009 Price: £ 74.31

### Connection hose Pneumatic 4 m

Part ref. 824 02 027 Price: £ 46.22

### Schuko sockets

220 V, 16 A, Alternating Current  
Open fronted version  
Part ref. 500 01 001 Price: £ 37.37  
with folding cover  
Part ref. 500 01 002 Price: £ 47.20



### FI protection switch

220 V  
Part ref. 501 01 002 Price: £ 160.49  
380 V  
Part ref. 501 01 001 Price: £ 145.82



### CEE socket

220 V, 16 A, Alternating Current 2 P + E  
Part ref. 500 01 005 Price: £ 60.46  
380 V, 16 A, 3 phase supply, 3 P + E  
Part ref. 500 01 006 Price: £ 70.80



### Compressed air outlet to 35 bar

Part ref. 800 01 001 Price: £ 49.17



### Mains protection circuit breaker

for Alternating Current, 220 V, 16 A  
Part ref. 501 02 001 Price: £ 57.04  
for 3 phase supply, 380 V, 16 A  
Part ref. 501 02 002 Price: £ 169.14



### Emergency isolator

manual operation  
Part ref. 501 03 001 Price: £ 72.77



### Warning lights

red  
Part ref. 505 01 001 Price: £ 82.61  
yellow  
Part ref. 505 01 002 Price: £ 82.61



### Key switch

with 2 keys  
Part ref. 501 03 002 Price: £ 116.04



Standard paint finish

RAL 7035 light grey

Easily and quickly assembled with no fixings.  
 Welded tubular steel frame with toolbox stand on model W 1000.  
 30 mm thick Multiplex worktop with rounded and protected edges.  
 Retention bar to lock bench in place & prevent folding.

Standard colour: RAL 8019, grey brown

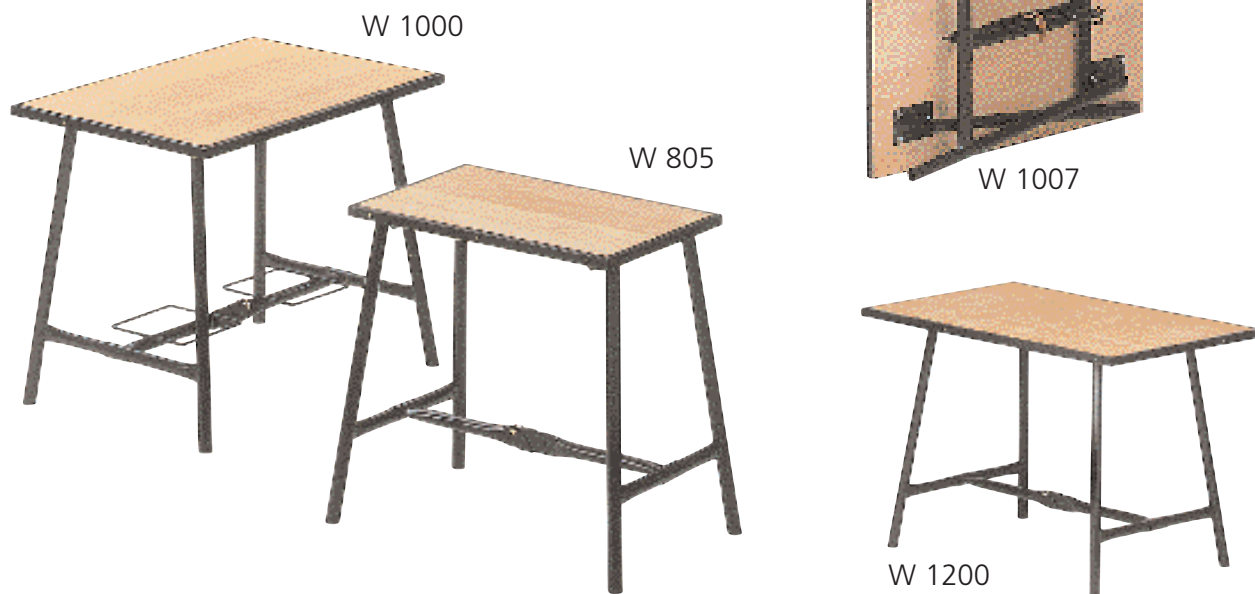

| Description              | Dimensions W x D x H mm | Weight kg | Part ref.  | Price £ |
|--------------------------|-------------------------|-----------|------------|---------|
| W 805                    | 800 x 500 x 840         | 22.0      | 110 25 004 | 111.00  |
| W 1007                   | 1000 x 700 x 840        | 30.0      | 110 25 001 | 115.00  |
| W 1200                   | 1200 x 750 x 840        | 36.0      | 110 25 003 | 135.00  |
| W 1000 with toolbox rack | 1000 x 500 x 840        | 32.0      | 110 25 002 | 118.00  |

Drawer  
Cabinets

Workbenches

Workstation  
Systems APS

Mobile  
Equipment

Storage  
Cupboards

Combination Drawer  
& Shelving System

Drawer  
Dividers

Perfo® System

CNC System

Cases

### Quality vice with tube clamping jaws

Available in 4 jaw widths. The forged jaws provide secure clamping of pipes and are therefore ideally suited to installation work.

All highly stressed parts like front and rear jaws, anvil, spindle, and guide rails are produced from high quality drop-forged steel.

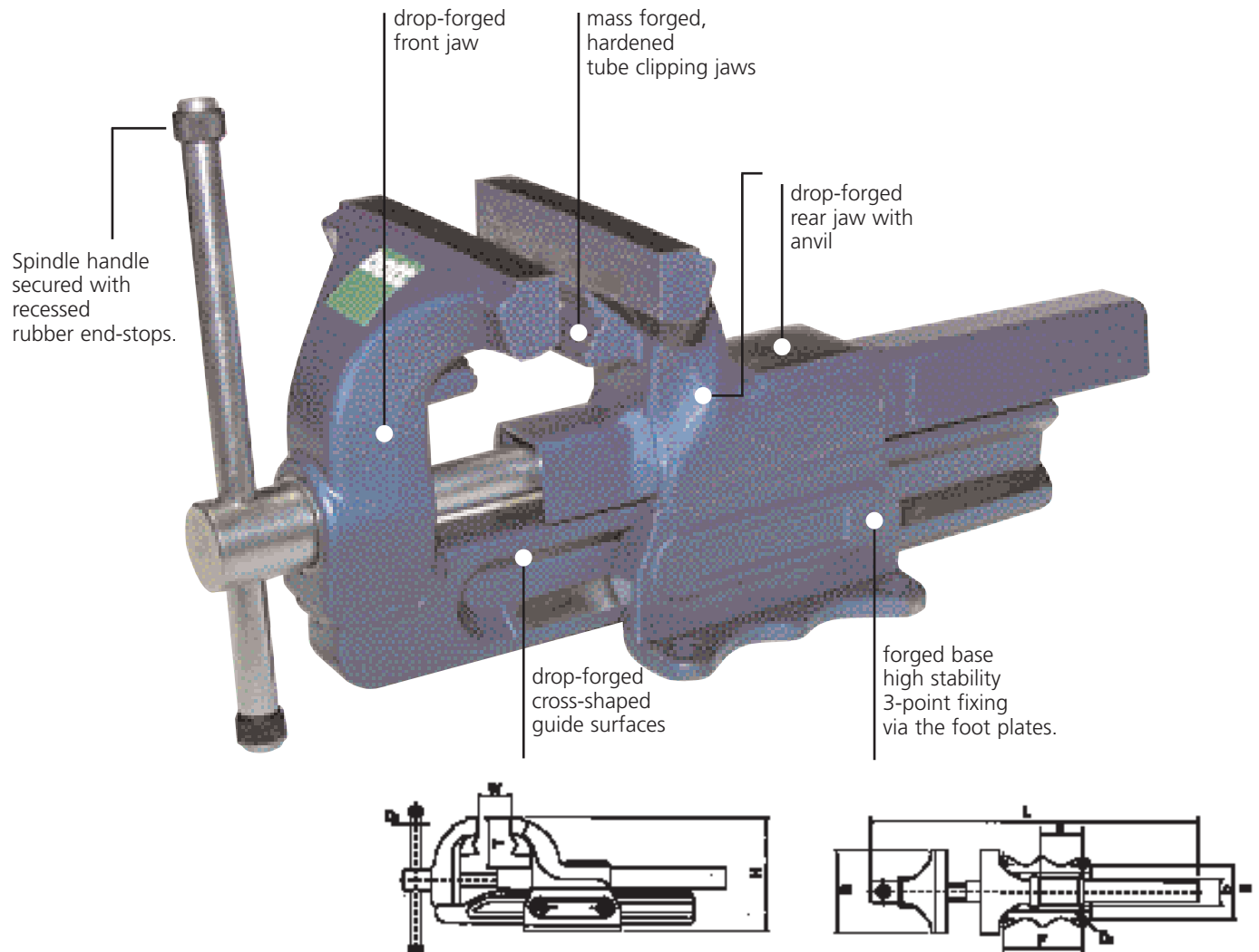

#### Technical data Vice

| Size                               |       |      | 100     | 120     | 140      | 160       |
|------------------------------------|-------|------|---------|---------|----------|-----------|
| Jaw width                          | W     | mm   | 100     | 120     | 140      | 160       |
| max. jaw opening                   | W     | ≈ mm | 130     | 150     | 200      | 230       |
| Jaw depth                          | S     | mm   | 55      | 70      | 87       | 103,5     |
| Vice height                        | H     | mm   | 127     | 163,5   | 194,5    | 230       |
| Anvil size                         | axb   | mm   | 35 x 35 | 50 x 40 | 58 x 55  | 70 x 60   |
| Spindle diameter                   | D2    | mm   | 13      | 13      | 16       | 18        |
| Fixing hole diameter               | D1    | mm   | 9,5     | 11,5    | 11,5     | 14        |
| fixing hole spacing                | F x E |      | 72 x 58 | 97 x 76 | 119 x 95 | 139 x 121 |
| Total length                       | L     | mm   | 290     | 370     | 465      | 550       |
| Weight                             |       | ≈ kg | 4,5     | 9       | 16       | 27        |
| Clamps tubes from/to               |       | mm   | Y 13-40 | Y 16-58 | Y 18-80  | Y 18-98   |
| Weight of the turntable (complete) |       | ≈ kg | 1,5     | 2,5     | 5        | 7,5       |

# Workbench accessories

## Vices

### Anvil

work-hardened, suitable for repair and bench work, jaws are milled, surface hardened (54-58 Rockwell C) and parallel closing.

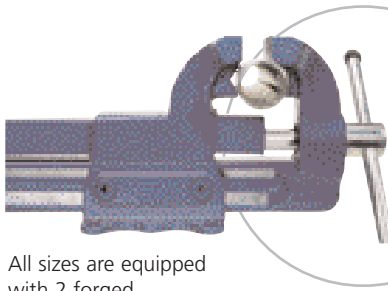

All sizes are equipped with 2 forged induction-hardened tube clamping jaws.

Forged jaws provide for secure clamping of pipes and are therefore ideally suited for installation work.

### Turntable

2-piece, consisting of guide ring and spacer, allows 360 degree movement of the vice. Infinite adjustment via integral locking screw.



### Cross-shaped guide surfaces

forged steel, sealed against dirt and damage. The newly designed and highly engineered X-form guides, with tighter tolerances, reduce slack and promotes smooth, low friction parallel movement.

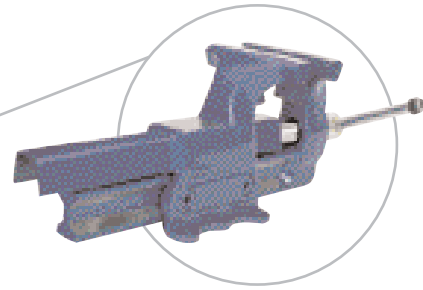

### Height adjustment device

provides smooth vertical adjustment, 360 degree rotation, gas strut assisted lift (max. 240 mm)

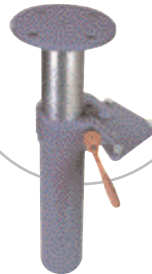

### Automatic folding lift

allows the vice to be folded beneath the workbench.

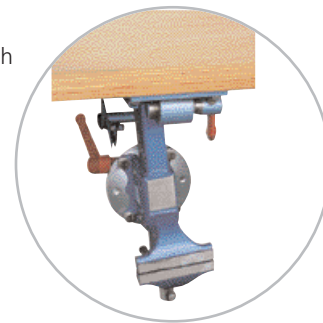
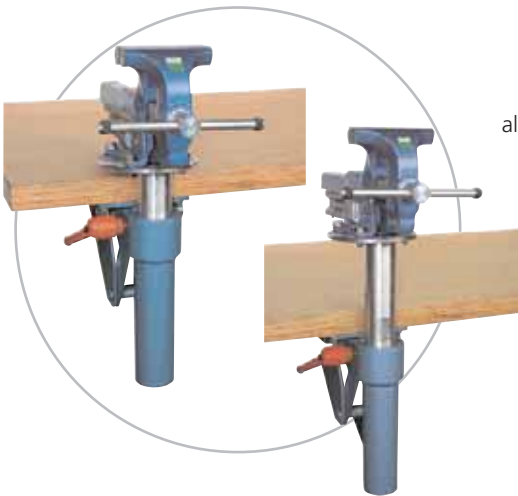

| Description   | Part ref.  | Price £ |
|---|------------|---------|
| Vice with jaw width 100 mm                              | 806 01 015 | 100.35  |
| Vice with jaw width 120 mm                              | 806 01 016 | 121.96  |
| Vice with jaw width 140 mm                              | 806 01 017 | 160.86  |
| Vice with jaw width 160 mm                              | 806 01 018 | 217.45  |
| Turntable for vice with jaw width 100 mm                | 806 10 001 | 39.57   |
| Turntable for vice with jaw width 120 mm                | 806 10 002 | 50.02   |
| Turntable for vice with jaw width 140 mm                | 806 10 003 | 62.74   |
| Turntable for vice with jaw width 160 mm                | 806 10 004 | 75.33   |
| Height adjustment device for vice with jaw width 100 mm | 806 13 001 | 167.02  |
| Height adjustment device for vice with jaw width 120 mm | 806 13 002 | 181.65  |
| Height adjustment device for vice with jaw width 140 mm | 806 13 003 | 181.65  |
| Height adjustment device for vice with jaw width 160 mm | 806 13 004 | 172.51  |
| Automatic folding lift* for vice with jaw width 100 mm  | 806 13 005 | 277.83  |
| Automatic folding lift* for vice with jaw width 120 mm  | 806 13 006 | 287.19  |

\* incl. height adjustment device



## Workstand

- Gas spring assisted height and seat tilt adjustment
- Seat angle adjustment 0° - 8°
- Durable and comfortable moulded foam seat

| Description | Height mm  | Part ref.  | Price £ |
|-------------|------------|------------|---------|
| Workstand   | 550-660 mm | 886 01 022 | 122.00  |

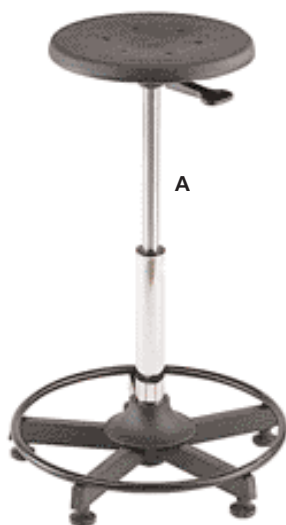

## Stool – fixed and with castors

- For stool - fixed and with castors - Gas spring assisted height adjustment
- For stool - fixed and with castors - Low wear polyurethane seat

| Fig.     | Description  | Height mm  | Part ref.  | Price £ |
|----------|--------------|------------|------------|---------|
| <b>A</b> | Fixed stool  | 510-770 mm | 886 01 020 | 97.00   |
| <b>B</b> | Roller stool | 360-475 mm | 886 01 003 | 119.00  |
| <b>C</b> | Roller stool | 510-770 mm | 886 01 002 | 133.00  |



## Classic chairs

- Backrest angle adjustment up to 10°
- Backrest adjustable in height
- Seat tilt can be free floating or fixed in any position
- High quality gas lift mechanism for automatic seat height adjustment
- Model "B" includes footrest

| Fig. | Height mm | Part ref.  | Price £ |
|------|-----------|------------|---------|
| A    | 430-560   | 886 01 008 | 140.00  |
| B    | 550-800   | 886 01 007 | 153.00  |



## Comfort chairs

- Max. 10° backrest angle adjustment
- Height adjustable and pivotable backrest cushions
- Seat tilt can be free floating or fixed in any position
- Easy care vinyl backrest and seat with air vents
- High quality gas filled springs for automatic seat height adjustment
- Model "D" includes all-round circular footrest
- Moulded dense foam seat and backrest

| Fig. | Height mm | Part ref.  | Price £ |
|------|-----------|------------|---------|
| C    | 430-560   | 886 01 010 | 157.00  |
| D    | 550-800   | 886 01 009 | 207.00  |



## Active chairs

- Max. 10° backrest angle adjustment
- Height adjustable and pivotable seat cushions
- Seat tilt can be free floating or fixed in any position
- Seat cushions and backrest with blue fabric covers and soft plastic edgebanding to prevent fraying
- High quality gas filled springs for automatic seat height adjustment
- Model »F« includes a footrest

| Fig. | Height mm | Part ref.  | Price £ |
|------|-----------|------------|---------|
| E    | 430-560   | 886 01 012 | 141.00  |
| F    | 490-670   | 886 01 011 | 160.00  |



## Accessories for chairs

| Fig. | Description              | Part ref.  | Price £ |
|------|--------------------------|------------|---------|
| G    | Armrest set              | 886 02 004 | 44.00   |
| H    | Set of castors for chair | 886 02 003 | 33.00   |

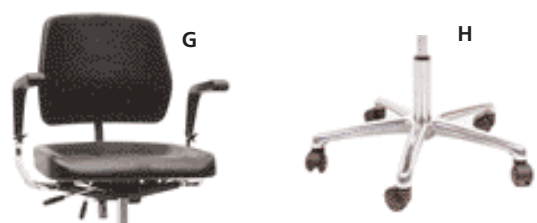

Drawer  
Cabinets

Workbenches

Workstation  
Systems  
APS

Mobile  
Equipment

Storage  
Cupboards

Combination  
Drawer  
& Shelving  
System

Drawer  
Dividers

Perfo®  
System

CNC System

Cases

[www.bott-group.com](http://www.bott-group.com)

## **Bott Ltd**

Bude & Stratton Business Park, Bude  
Cornwall. EX23 8LY

Tel: 01288 357 788

Fax: 01288 352 692

Email: [info@bottltd.co.uk](mailto:info@bottltd.co.uk)

Web: [www.bott-group.com](http://www.bott-group.com)

.50

April 2007

@2007MC1.50