

INTEGRATED PASSIVE COMPONENTS

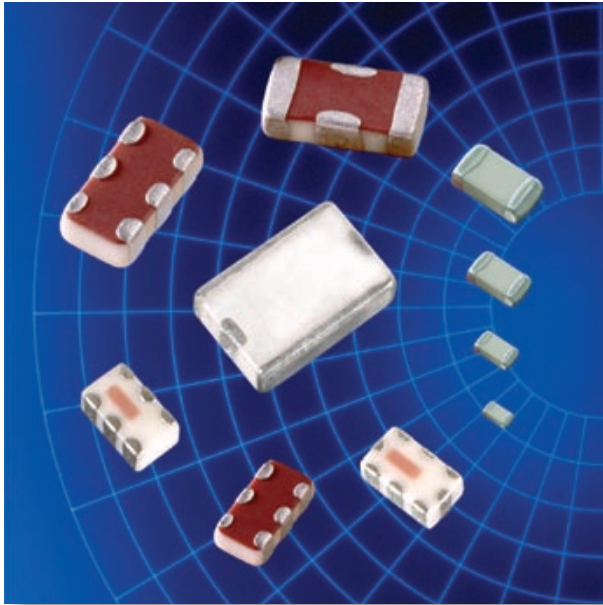

Johanson Technology has developed a line of small, highly reliable RF ceramic components manufactured with a proprietary LTCC (low temperature co-fired ceramic) process. These components operate over several bands from 900MHz to 6 GHz covering Cellular, DECT, WLAN, Bluetooth, 802.11 (a,b and g) and GPS applications.

In addition to the array of listed components we can support custom solutions for high volume applications with design flexibility and short development times. Contact us today with your specific technical requirements.

KEY FEATURES

- Custom Solutions
- LTCC Based Designs
- Low Insertion Loss
- Miniature Size / Low Profile
- Temperature Stable
- Surface Mount
- RoHS Compliant, Standard, Use No Suffix

SUPPORTED APPLICATION BANDS

- Wireless LAN, Bluetooth, Home RF
- GSM/EDGE/GPRS/DCS/PCS/WCDMA
- WiMAX 802.16
- 2.4 GHz & 5.5 GHz ISM Band
- Zigbee
- MiMo
- GPS
- UNII
- UWB

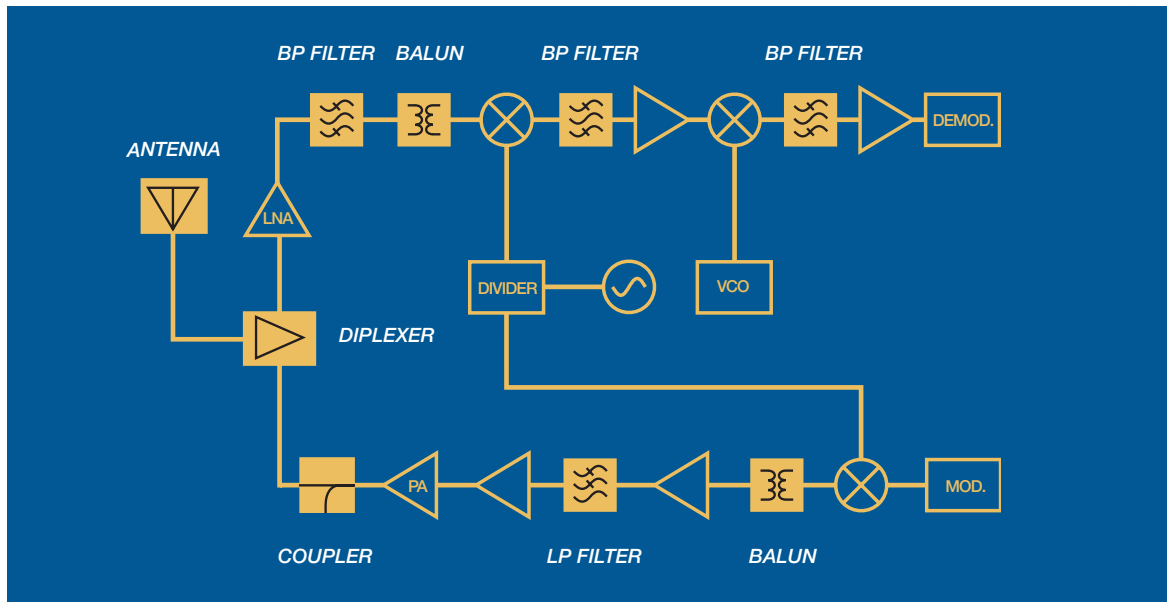

CERAMIC CHIP ANTENNAS

Part Number	Frequency (MHz)	Peak Gain	Ave. Gain	Return Loss	Case Size
0920AT50A080	880 - 960	-0.7 dBi typ (XZ-V)	-2.6 dBi typ (XZ-V)	8.5 dB min.	Case 50
1575AT43A40	1555 - 1595	-1.5 dBi typ (XZ-V)	-2.5 dBi typ (XZ-V)	9.5 dB min.	Case 43-1
1575AT47A40_	1555 - 1595	-1.0 dBi typ (XZ-V)	-3.0 dBi typ (XZ-V)	9.5 dB min.	Case 47-1
2450AT18A100	2400 - 2500	0.5 dBi typ (XZ-V)	-0.5 dBi typ (XZ-V)	9.5 dB min.	Case 18-4
2450AT42A100	2400 - 2500	0 dBi typ (XZ-V)	-1 dBi typ (XZ-V)	9.5 dB min.	Case 42-1
2450AT42B100	2400 - 2500	0 dBi typ (XZ-V)	-1.5 dBi typ (XZ-V)	9.5 dB min.	Case 42-2
2450AT43A100	2400 - 2500	2.0 dBi typ (XZ-V)	0.5 dBi typ (XZ-V)	9.5 dB min.	Case 43-1
2450AT43B100	2400 - 2500	1.0 dBi typ (XZ-V)	-0.5 dBi typ (XZ-V)	9.5 dB min.	Case 43-2
2450AT44A100_	2400 - 2500	1.3 dBi typ (XZ-V)	0 dBi typ (XZ-V)	9.5 dB min.	Case 44-1
2450AT45A100_	2400 - 2500	3.0 dBi typ (XZ-V)	1.0 dBi typ (XZ-V)	9.5 dB min.	Case 45-1
2450AD46A5400 (Dual Band)	LB: 2400 - 2500 HB: 4900 - 5900	1.0 dBi typ (XZ-V) -2.5 dBi typ (XZ-V)	-1.5 dBi typ (YZ-V) -2.5 dBi typ (YZ-V)	8.5 dB min. 8.5 dB min.	Case 46-1
2500AT52M5355	WiMax (Tri-Band)	See spec sheet	See spec sheet	9.5 dB min.	TBD
5250AT43A200_	5150 - 5350	3.6 dBi typ (XZ-V)	-2.3 dBi typ (XZ-V)	9.5 dB min.	Case 43-1
5400AT18A1000	4900 - 5900	2.0 dBi typ. (XZ-V)	-2.5 dBi typ (XZ-V)	9.5 dB min.	Case 18-4
5775AT43A100_	5725 - 5825	3.9 dBi typ (XZ-V)	-1.5 dBi typ (XZ-V)	9.5 dB min.	Case 43-1

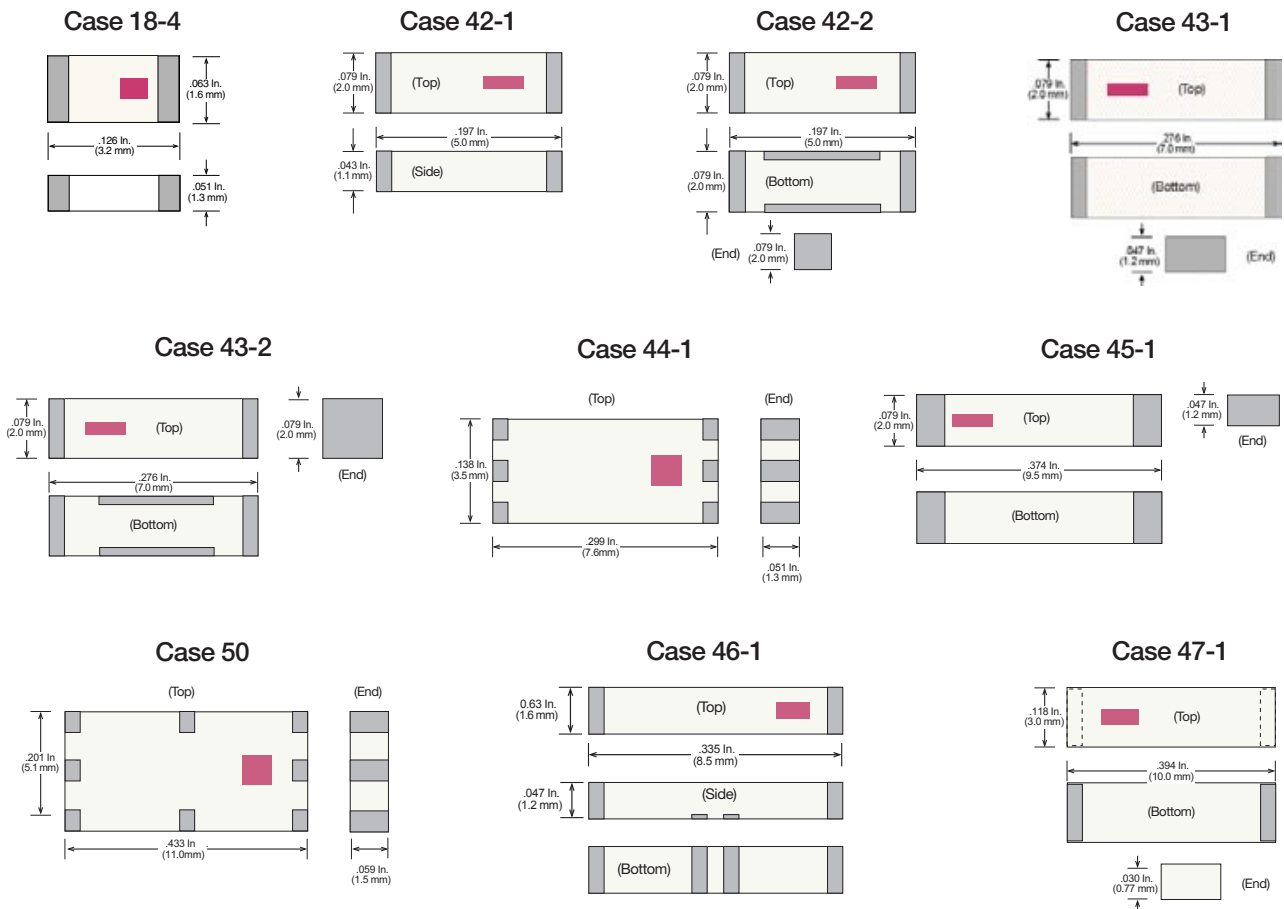

Detailed specifications and performance curves for the RF Ceramic Component line are located on our website.

BAND-PASS FILTERS: 2.45 GHZ

Part Number	Frequency (MHz)	Insertion Loss (max)	Attenuation (min)	Return Loss (min)	Ripple (typical)	Case Size
2450BP14C0100	2450 ± 50	2.0 dB	TBD	9.5 dB	-	Case 14-TBD
2450BP15B100	2450 ± 50	2.2 dB	25 dB @ 1200-1300 MHz 10 dB @ 2000 MHz 12 dB @ 3000 MHz 30 dB @ 3600-3800 MHz 34 dB @ 4800-5000 MHz	9.5 dB	-	Case 15-3
2450BP15D100	2450 ± 50	2.6 dB (Prelim.)	30 dB @ 880 - 1990 MHz (Prelim.) 20 dB @ 2110 - 2170 MHz (Prelim.) 30 dB @ 4800 - 5000 MHz (Prelim.) 20 dB @ 7200 - 7500 MHz (Prelim.)	9.5 dB	-	Case 15-1F
2450BP15C100	2450 ± 50	2.2 dB (Prelim.)	30 dB @ 1200-1300 MHz (Prelim.) 15 dB @ 2000 MHz (Prelim.) 25 dB @ 3000 MHz (Prelim.) 20 dB @ 3600-3800 MHz (Prelim.) 20 dB @ 4800-5000 MHz (Prelim.)	9.5 dB	-	Case 15-3B
2450BP15E0100	2450 ± 50	1.5 dB	TBD	9.5 dB	-	Case 15-3C
2450BP18C100A	2450 ± 50	2.5 dB	40 dB @ 1.2-1.8GHz 25 dB @ 2.1GHz 35 dB @ 4.8-5.0GHz 25 dB @ 7.2-7.5 GHz	9.5 dB	0.7 dB	Case 18-1
2450BP18C100B	2450 ± 50	2.0 dB	30 dB @ 1.75 GHz 25 dB @ 2.10 GHz 22 dB @ 4.8-5.0 GHz	9.5 dB	0.7 dB	Case 18-2
2450BP18C100C	2450 ± 50	2.5 dB	30 dB @ 1.2-1.8 GHz 25 dB @ 2.1 GHz 35 dB @ 4.8-5.0 GHz	9.5 dB	0.7 dB	Case 18-3A
2450BP18C100D	2450 ± 50	2.0 dB	40 dB @ 900-928 MHz 30 dB @ 1.2-1.8 GHz 25 dB @ 2.1 GHz 35 dB @ 4.8-5.0 GHz 30 dB @ 7.2-7.5 GHz	9.5 dB	0.7 dB	Case 18-3B
2450BP18D100A	2450 ± 50	TBD dB	TBD	TBD dB	TBD dB	Case 18-3C
2450BP39C100A	2450 ± 50	2.5 dB	42 dB @ 1.71-1.99 GHz 30 dB @ 2.1 GHz 30 dB @ 4.8-5.0 GHz	9.5 dB	0.7 dB	Case 39-1
2450BP39C100B	2450 ± 50	1.8 dB	30 dB @ 1.71-1.78 GHz 25 dB @ 1.85-1.91 GHz 25 dB @ 4.8-5.0 GHz	9.5 dB	0.7 dB	Case 39-1
2450BP39C100C	2450 ± 50	1.5 dB	30 dB @ 800-915 MHz 30 dB @ 1710-1785 MHz 25 dB @ 1850-1910 MHz 25 dB @ 4800-5000 MHz 15 dB @ 7200-7500 MHz	9.5 dB	-	Case 39-1
2450BP39D100B	2450 ± 50	2.5 dB	35 dB @ 880 - 915 MHz 18 dB @ 1710 - 1990 MHz 12 dB @ 2100 MHz 35 dB @ 3200 MHz 22 dB @ 4800 - 5000 MHz 22 dB @ 7200 - 7500 MHz	9.5 dB	-	Case 39-1

Basic case size drawings for above part numbers are located on page 37.

Detailed specifications and performance curves for the RF Ceramic Component line are located on our website.

BAND-PASS FILTERS: 2.45 GHz

Part Number	Frequency (MHz)	Insertion Loss (max)	Attenuation (min)	Return Loss (min)	Ripple (typical)	Case Size
2450BP39D100C	2450 ± 50	1.2 dB	30 dB @ 880-915 MHz 30 dB @ 1710 - 1785 MHz 25 dB @ 1850 - 1910 MHz 25 dB @ 4800 - 5000 MHz 15 dB @ 7200 - 7500 MHz	9.5 dB	-	Case 39-1
2450BP39E100A	2450 ± 50	2.6 dB	42 dB @ 880 - 915 MHz 20 dB @ 1710 - 1990 MHz 8 dB @ 2110 - 2170 MHz 20 dB @ 2700 MHz 27 dB @ 4800 - 5000 MHz 15 dB @ 7200 - 7500 MHz	9.5 dB	-	Case 39-1
2450BP41D100	2450 ± 50	2.5 dB	40 dB @ 1.2-1.8 GHz 30 dB @ 2.1 GHz 35 dB @ 4.8-5.0 GHz	9.5 dB	0.7 dB	Case 41-1
2450BP41D100A	2450 ± 50	2.3 dB	40 dB @ 1.2-1.8 GHz 30 dB @ 2.1 GHz 12 dB @ 2.2 GHz 35 dB @ 4.8-5.0 GHz	9.5 dB	0.7 dB	Case 41-1
2450BP41D100B	2450 ± 50	1.3 dB	30 dB @ 880-915 MHz 30 dB @ 1.71-1.785 GHz 20 dB @ 1.85-1.91 GHz 25 dB @ 4.8-5.0 GHz 20 dB @ 7.2-7.5 GHz	9.5 dB	0.7 dB	Case 41-1

BAND-PASS FILTERS: 5.5 GHz

Part Number	Frequency (MHz)	Insertion Loss (max)	Attenuation (min)	Return Loss (min)	Ripple	Case Size
5450BP15T600	5450 ± 300	2.0 dB (Prelim.)	25 dB @ 3.3 GHz (Prelim.) 15 dB @ 6.485 GHz (Prelim.) 25 dB @ 12 GHz (Prelim.)	NA	-	Case 15-3C
5487BP15B675	5150 - 5825	1.8 dB	35 dB @ 2.57-2.90 GHz 22 dB @ 10.3-11.6 GHz 30 dB @ 15.45-17.47 GHz	9.5 dB	0.7 dB	Case 15-1B
5487BP15C675	5150 - 5825	1.8 dB	35 dB @ 2.57-2.90 GHz 27 dB @ 10.3-11.65 GHz 20 dB @ 15.45-17.475 GHz	9.5 dB	0.7 dB	Case 15-1B
5515BP15B725	5150 - 5875	1.5 dB	30 dB @ 3500 MHz	9.5 dB	-	Case 15-3B
5515BP15B730	5150 - 5875	2.8 dB	30 dB @ 0.5-4.0 GHz 25 dB @ 10.3-11.8 GHz 20 dB @ 4.6 GHz	9.5 dB	0.7 dB	Case 15-1B
5515BP15B975	4900 - 5875	1.5 dB	30 dB @ 3500 MHz	9.5 dB	-	Case 15-3B
5515BP15C725	5150 - 5875	2.0 dB	30 dB @500-4000 MHz 20 dB @4600 MHz 15 dB @10.3-11.8 GHz	8.5 dB	-	Case 15-3B
5515BP15C975	4900 - 5875	1.8 dB	30 dB @ 500-4000MHz 20 dB @ 4200MHz 15 dB @ 9800-11750MHz	8.5 dB	-	Case 15-3B
5515BP15C1020	4900 - 5920	1.5 dB	30 dB @ 3500 MHz	9.5 dB	-	Case 15-3B

Basic case size drawings for above part numbers are located on page 37.

Detailed specifications and performance curves for the RF Ceramic Component line are located on our website.

BAND-PASS FILTERS: OTHER

Part Number	Frequency (MHz)	Insertion Loss (max)	Attenuation (min)	Return Loss (min)	Ripple (typical)	Case Size
1810BP07B200	1800 ± 100	1.8 dB (Prelim.)	20 dB @ 855-955 (Prelim.) 10 dB @ 2565-2865 (Prelim.)	TBD	-	Case 07-1
1906BP18A027	1900 ± 50	1.5 dB	38 @ 1405-1440 MHz 10 @ 1649-1680 MHz 24 @ 3786-3840 MHz 20 @ 5679-5760 MHz	9.5 dB	-	Case 18-3B
1906BP18C027	1893-1920	2.0 dB	TBD	9.5 dB	-	Case 18-TBD
2593BP44B186	2500 - 2686	2.0 dB	40 dB @ 1870-2056 MHz	9.5 dB	-	Case 44-1
3600BP15M600	3300 - 3900 (Prelim)	1.8 dB (Prelim.)	15 dB @ 0.1-2.6 GHz (Prelim.) 9 dB @ 4.4 GHz (Prelim.) 20 dB @ 6.0-9.9 GHz (Prelim.)	9.5 dB (Prelim.)	-	Case 15-3B
4000BP15U1800	3100 - 4900	2.0 dB	25 dB @ 1.75 GHz 13 dB @ 2.10 GHz	8.5 dB	-	Case 15-2B
5130BP18U4060	3100 - 7160	1.6 dB	25 dB @ 824 - 960 MHz 25 dB @ 1710 - 1990 MHz 15 dB @ 2400 - 2500 MHz 20 dB @ 10100 - 10600 MHz	9.5 dB	-	Case 18-4

HIGH-PASS FILTERS

Part Number	Frequency (MHz)	Insertion Loss (max)	Attenuation (min)	Return Loss (min)	Case Size
1900HP41A500	1900 ± 250	2.0 dB (Prelim)	30 dB @ 950 - 1450 MHz (Prelim)	8.5 dB	Case 41-1 (Prelim)
2450HP14A100	2450 ± 50	1.0 dB (Prelim.)	9 dB @ 824 - 960 MHz (Prelim.) 20 dB @ 1917 MHz (Prelim)	9.5 dB	Case 14-1B

EMI FILTER

Part Number	No. of Sections	Cutoff Freq (MHz)	Attenuation (min)	Case Size
0200FA18A0200	4	200	20 dB @ 800 - 1200 MHz 10 dB @ 1500 - 3000 MHz	Case 18-4
0400FA15A0400	4	400	20 dB @ 800 - 1000 MHz	Case TBD
0400FA18A0400	4	400	20 dB @ 850 - 1200 MHz 10 dB @ 1500 - 2500 MHz	Case 18-4

Basic case size drawings for above part numbers are located on page 37.

Detailed specifications and performance curves for the RF Ceramic Component line are located on our website.

LOW-PASS FILTERS

Part Number	Frequency (MHz)	Insertion Loss (max)	Attenuation (min)	Return Loss (min)	Case Size
0500LP15A500	0 - 500	0.70 dB	9 dB @ 824 - 960 MHz 25 dB @ 1710 - 1990 MHz 25 dB @ 2400 - 4000 MHz	9.5 dB	Case 15-1A
0869LP14A090	824 - 915	0.60 dB	20 dB @ 2xFo 15 dB @ 3xFo	10.9 dB	Case 14-1
0892LP07A136	824 - 960	0.70 dB	18 dB @ 1648 - 1920 MHz 25 dB @ 2472 - 2880 MHz 25 dB @ 3296 - 3840 MHz	9.5 dB	Case 07-1
0898LP18A035	880 - 915	0.60 dB	30 dB @ 2xFo 18 dB @ 3xFo	10.9 dB	Case 18-2
0915LP15A026	902 - 928	0.65 dB	25 dB @ 2xFo 25 dB @ 3xFo	9.5 dB	Case 15-2A
0915LP15B026	902 - 928	0.50 dB	30 dB @ 2xFo 30 dB @ 3xFo	14.0 dB	Case 15-2A
1200LP41A500	950 - 1450	2.0 dB (Prelim)	27 dB @ 1650 - 2150 MHz (Prelim)	8.5 dB	Case 41-1 (Prelim)
1748LP18A075	1710 - 1785	0.60 dB	30 dB @ 2xFo 18 dB @ 3xFo	10.9 dB	Case 18-2
1810LP07A200	1710 - 1910	0.50 dB	20 dB @ 2xFo 20 dB @ 3xFo	10.9 dB	Case 07-1
1810LP07B200	1710 - 1910	0.60 dB (Prelim)	26 dB @ 3420 - 3570 MHz (Prelim) 21 dB @ 3700 - 3820 MHz (Prelim) 21 dB @ 5130 - 5730 MHz (Prelim)	9.5 dB	Case 07-1
1810LP14A200	1710 - 1910	0.60 dB	30 dB @ 3420 - 3570 MHz 25 dB @ 3700 - 3820 MHz 20 dB @ 5130 - 5730 MHz	11.7 dB	Case 14-1
1880LP14A060	1850 - 1910	0.60 dB	27 dB @ 2xFo 19 dB @ 3xFo	11.7 dB	Case 14-1
2442LP18A083	2400 - 2483	0.60 dB	30 dB @ 2xFo 18 dB @ 3xFo	10.9 dB	Case 18-2
2450LP14A100	2400 - 2500	0.50 dB	25 dB @ 2xFo 18 dB @ 3xFo	14.0 dB	Case 14-1
2450LP14B100	2400 - 2500	0.50 dB	35 dB @ 2xFo 25 dB @ 3xFo	14.0 dB	Case 14-1
2450LP14C100	2400 - 2500	0.60 dB	27 dB @ 2xFo 25 dB @ 3xFo	11.7 dB	Case 14-1
2450LP15A050	2400 - 2500	0.50 dB	27 dB @ 2xFo 25 dB @ 3xFo	10.9 dB	Case 14-1
3550LP14A300	3400 - 3700	0.65 dB	25 dB @ 2xFo 25 dB @ 3xFo	14.0 dB	Case 14-1
5515LP15A730	5150 - 5875	0.50 dB	25 dB @ 2xFo	10.9 dB	Case 15-2A

Basic case size drawings for above part numbers are located on page 37.

Detailed specifications and performance curves for the RF Ceramic Component line are located on our website.

DIRECTIONAL COUPLERS

Part Number	Frequency (MHz)	Insertion Loss (max)	Return Loss (min)	Coupling (dB)	Isolation (min.)	Case Size
0848CP14A075	810 - 885	0.25 dB	15.6 dB	20.3 ± 1.0 dB	28.0 dB	Case 14-1
0869CP14A090	824 - 915	0.3 dB	15.6 dB	17 ± 1.0 dB	26.0 dB	Case 14-1
0898CP14A035	880 - 915	0.28 dB	15.6 dB	18 ± 1.0 dB	26.0 dB	Case 14-1
0898CP14B035	880 - 915	0.25 dB	15.6 dB	20 ± 1.0 dB	28.0 dB	Case 14-1
0898CP15A035	880 - 915	0.50 dB	14.0 dB	20 ± 1.0 dB	25.0 dB	Case 15-1C
0967CP14A024	955 - 979	0.50 dB	15.6 dB	12.5 ± 1.0 dB	19.0 dB	Case 14-1
1747CP14A075	1710 - 1785	0.44 dB	15.6 dB	14.5 ± 1.0 dB	25.0 dB	Case 14-1
1748CP15A075	1710 - 1785	0.50 dB	14.0 dB	20 ± 1.0 dB	25.0 dB	Case 15-1C
1810CP14A200	1710 - 1910	0.30 dB	15.6 dB	20 ± 1.0 dB	25.0 dB	Case 14-1
2450CP14A100	2400 - 2500	0.74 dB	TBD dB	10 ± 1.0 dB	22.0 dB	Case 14-1
2450CP14B100	2400 - 2500	0.34 dB	TBD dB	17.65 ± 1.0 dB	25.0 dB	Case 14-1
5000CP14A200	4000 - 6000	TBD dB	TBD dB	20 ± TBD dB	25.0 dB (Prelim.)	Case 14-1

DIRECTIONAL COUPLER - SPLITTER, 3 dB HYBRID

Part Number	Frequency (MHz)	Insertion Loss (max)	Return Loss (min)	Isolation (min.)	Case Size
0880CH15A060	850 - 910	3.3 ± 0.5 dB	14.0 dB	20.0 dB	Case 15-4
1950CH15A100	1900 - 2000	3.3 ± 0.5 dB	14.0 dB	16.0 dB	Case 15-4

DIRECTIONAL COUPLER WITH LOW PASS FILTER

Part Number	Frequency (MHz)	Insertion Loss (max)	Return Loss (min)	Coupling (dB)	Isolation (min.)	Attenuation (min.) 2 x Fo 3 x Fo	Case Size
0898CF15A035_	880 - 915	0.7 dB	14 dB	20 ± 1.0	25.0 dB	22.0 dB 17.0 dB	Case 15-1C
1748CF15A075_	1710 - 1785	0.5 dB	14 dB	20 ± 1.0	25.0 dB	22.0 dB 17.0 dB	Case 15-1C

DIRECTIONAL COUPLER - DUAL BAND, SINGLE PATH

Part Number	Frequency (MHz)	Insertion Loss (max)	Return Loss (min)	Coupling (dB)	Isolation (min.)	Case Size
0869CP14B1050	B1) 824 - 915	0.4 dB	15.6 dB	14.2 ± 1.0	23.0 dB	Case 14-1
	B2) 999 - 1102	0.6 dB	15.6 dB	12.7 ± 1.0	22.0 dB	

DIRECTIONAL COUPLER - DUAL BAND, DUAL PATH

Part Number	Frequency (MHz)	Insertion Loss (max)	Return Loss (min)	Coupling (dB)	Isolation (min.)	Case Size
0898CD15B1748	B1) 880 - 915	0.40 dB	10.9 dB	19.2 ± 1.0	B1 In > B2 Out: 35.0 dB B1 In > B2 In: 25.0 dB B1 Out > B2 In: 25.0 dB B1 In > Term: 23.0 dB B2 In > Term: 23.0 dB	Case 15-2A
	B2) 1710 - 1785	0.4 dB	10.9 dB	19.2 ± 1.0		
0898CD15C1748	B1) 1710 - 1785	0.45 dB	10.9 dB	14.0 ± 1.5	B1 In > B2 Out: 35.0 dB B1 In > B2 In: 24.0 dB B1 Out > B2 In: 24.0 dB B1 In > Term: 24.0 dB B2 In > Term: 24.0 dB	Case 15-2A
	B2) 880 - 915	0.35 dB	10.9 dB	19.2 ± 1.0		
0898CD15D1748	B1) 880 - 915	0.35 dB	14.0 dB	19.0 ± 1.0	B1 In > B2 Out: 25.5 dB B1 In > B2 In: 21.0 dB B1 Out > B2 In: 22.0 dB B1 In > Term: 17.0 dB B2 In > Term: 24.0 dB	Case 15-2A
	B2) 1710 - 1785	0.50 dB	14.0 dB	14.0 ± 1.5		

CERAMIC CHIP BALUNS

Part Number	Frequency (MHz)	Impedance Unbal./Bal.	Insertion Loss (max)	Return Loss (min)	Phase Difference	Amplitude Difference (max)	Case Size
0866BL15C200	800 - 900	50/200	TBD	TBD	180°±TBD°	TBD	Case 15-1D
0896BL14B050	851 - 941	50/50	1.5 dB	9.5 dB	180°±07°	0.7 dB	Case 14-1
0900BL15C050	800 - 1000	50/50	1.2 dB	9.5 dB	180°±10°	2.0 dB	Case 15-1D
0900BL18B100	889 -945	50/100	1.0 dB	9.5 dB	180°±10°	2.0 dB	Case 18-1
0900BL18B200	800 -1000	50/200	1.0 dB	9.5 dB	180°±10°	2.0 dB	Case 18-1
1450BL15A200	1400 -1500	50/200	1.0 dB	9.5 dB	180°±10°	2.0 dB	Case 15-1B
1600BL15B050	1500~1700	50/50	1.0 dB	9.5 dB	180°±10°	2.0 dB	Case 15-1B
1600BL15B100	1500~1700	50/100	1.0 dB	9.5 dB	180°±10°	2.0 dB	Case 15-1B
1800BL18B200	1700 - 1900	50/200	0.8 dB	9.5 dB	180°±10°	2.0 dB	Case 18-1
1850BL15B050	1700 - 2000	50/50	1.0 dB	9.5 dB	180°±10°	2.0 dB	Case 15-1B
1850BL15B100	1700 - 2000	50/100	1.0 dB	9.5 dB	180°±10°	2.0 dB	Case 15-1B
1850BL15B200	1700 - 2000	50/200	1.0 dB	9.5 dB	180°±10°	2.0 dB	Case 15-1B
2100BL18B200	2000 - 2200	50/200	0.8 dB	9.5 dB	180°±10°	2.0 dB	Case 18-1
2450BL14B050	2400 - 2500	50/50	1.5 dB	9.5 dB	180°±10°	2.0 dB	Case 14-1
2450BL14B100	2400 - 2500	50/100	1.3 dB	9.5 dB	180°±10°	2.0 dB	Case 14-1
2450BL14C050	2400 - 2500	50/50	1.2 dB	9.5 dB	180°±10°	2.0 dB	Case 14-1
2450BL14C100	2400 - 2500	50/100	1.2 dB	9.5 dB	180°±10°	1.5 dB	Case 14-1
2450BL14C200	2400 - 2500	50/200	1.3 dB	9.5 dB	180°±10°	2.0 dB	Case 14-1
2450BL15B050	2400 - 2500	50/50	1.0 dB	9.5 dB	180°±10°	2.0 dB	Case 15-1B
2450BL15B100	2400 - 2500	50/100	1.0 dB	9.5 dB	180°±10°	2.0 dB	Case 15-1B
2450BL15B150	2400 - 2500	50/150	1.0 dB	9.5 dB	180°±10°	2.0 dB	Case 15-1B
2450BL15B200	2400 - 2500	50/200	1.0 dB	9.5 dB	180°±10°	2.0 dB	Case 15-1B
2450BL15K050	2400 - 2500	50/50	1.2 dB	9.5 dB	180°±10°	2.0 dB	Case 15-1B
2450BL15K100	2400 - 2500	50/100	1.2 dB	9.5 dB	180°±10°	2.0 dB	Case 15-1B
2500BL14M050	2300 - 2700	50/50	1.2 dB (Prelim)	9.5 dB	180°±15°	1.5 dB	Case 14-1
2500BL14M100	2300 - 2700	50/100	1.2 dB (Prelim)	9.5 dB	180°±15°	1.5 dB	Case 14-1
3600BL14M050	3300 - 3900	50/50	1.2 dB (Prelim)	9.5 dB	180°±15°	1.5 dB	Case 14-1
3600BL14M100	3300 - 3900	50/100	1.2 dB (Prelim)	9.5 dB	180°±15°	1.5 dB	Case 14-1
3700BL15B050	3400 - 4000	50/50	1.2 dB	9.5 dB	180°±25°	2.0 dB	Case 15-1B
3700BL15B100	3400 - 4000	50/100	1.0 dB	9.5 dB	180°±20°	1.0 dB	Case 15-1B
3700BL15B200	3400 - 4000	50/200	1.2 dB	9.5 dB	180°±20°	1.0 dB	Case 15-1
4000BL14U100	3100 - 4800	50/100	1.2 dB	9.5 dB	180°±20°	1.5 dB	Case 14-1
5250BL14B100	5150 - 5350	50/100	1.0 dB	9.5 dB	180°±15°	1.5 dB	Case 14-1
5250BL15B100	5150 - 5350	50/100	1.2 dB	9.5 dB	180°±10°	2.0 dB	Case 15-1B
5325BL15B050	5150 - 5500	50/50	1.0 dB	9.5 dB	180°±10°	2.0 dB	Case 15-1B
5400BL14B100	5350 - 5450	50/100	1.2 dB (Prelim.)	TBD	TBD	TBD	Case 14-1
5400BL15B200	4900 - 5875	50/200	1.0 dB	9.5 dB	180°±10°	2.0 dB	Case 15-1B
5400BL15K050	4900 - 5875	50/50	1.2 dB	8.5 dB	180°±10°	2.0 dB	Case 15-1A
5512BL15B100	5150 - 5875	50/100	1.0 dB	11.7 dB	180°±10°	2.0 dB	Case 15-1B
5400BL15B050	4900 - 5900	50/50	1.0 dB	9.5 dB	180°±10°	2.0 dB	Case 15-1B
5400BL15B100	4900 - 5900	50/100	1.0 dB	9.5 dB	180°±10°	2.0 dB	Case 15-1B
5800BL15B100	5725 - 5875	50/100	1.0 dB	9.5 dB	180°±8°	0.75 dB	Case 15-1B

Detailed specifications and performance curves for the RF Ceramic Component line are located on our website.

BALUNS / MATCHING NETWORKS; SPECIFIC CHIPSET APPLICATIONS

Part Number	Frequency (MHz)	Unbalanced Impedance	Balanced Impedance	Insertion Loss (max)	Return Loss (min)	Phase Difference	Case Size
2450BM18A001	Tx: 2400 - 2500 Rx: 2400 - 2500	50 50	51.4 - j151.9 @ 2.45 GHz 6.5 - j43.8 @ 2.45 GHz	4.2 dB 5.0 dB	9.5 dB 9.5 dB	180°±10° 180°±10°	Case 18-4

CERAMIC CHIP BALUN FILTER

Part Number	Frequency (MHz)	Impedance Unbal./Bal.	Insertion Loss (max)	Return Loss (min)	Phase Difference	Case Size
2450FB15A050	2400 - 2500	50/50	1.5 dB	9.5 dB	180°±10°	Case 15-1A
2450FB39A050	2400 - 2500	50/50	2.0 dB	9.5 dB	180°±10°	Case 39-2
2450FB39B100	2400 - 2500	50/100	2.0 dB	9.5 dB	180°±10°	Case 39-2
2450FB39K001	2400 - 2500	50 / 22+j100	3.0 dB	9.5 dB	180°± 8°	Case TBD

CERAMIC CHIP BALUNS, DUAL BAND

Part Number	Frequency (MHz)	Impedance Unbal./Bal.	Insertion Loss (max)	Return Loss (min)	Phase Difference	Case Size
0918BD41B050	B1: 900 - 940 B2: 1850 - 1920	50/50 50/50	1.2 dB 1.7 dB	8.5 dB 8.5 dB	180°±10° 180°±10°	Case 41-2

CERAMIC CHIP DIPLEXERS - LPF / HPF

Part Number	Frequency (MHz)	Attenuation Low Band	Attenuation High Band	Return Loss (min.)	Case Size
0920DP18A1795_	880 - 960 1710 - 1880	0.75 dB max. 20 dB min.	20 dB min. 0.55 dB max.	12 dB 12 dB	Case 18-1
0967DP18A1795_	954 - 980 1710 - 1880	0.75 dB max. 20 dB min.	20 dB min. 0.55 dB max.	12 dB 12 dB.	Case 18-1
0859DP18A1920_	824 - 894 1850 - 1990	0.55 dB max. 20 dB min.	20 dB min. 0.55 dB max.	12 dB 12 dB	Case 18-1
0892DP14A1850_	824 - 960 1710 - 1990	0.50 dB max. 15 dB min.	25 dB min. 0.80 dB max.	12 dB 12 dB	Case 14-1
2450DP15A5512	2400 - 2500 5150 - 5875	0.70 dB max. 20 dB min.	15 dB min. 0.90 dB max.	9.5 dB 9.5 dB	Case 15-2A*
2450DP15B5512	2400 - 2500 5150 - 5875	0.70 dB max. 20 dB min.	15 dB min. 0.90 dB max.	9.5 dB 9.5 dB	Case 15-2A* * (opposite pin outs)

CERAMIC CHIP DIPLEXERS - LPF / BPF

Part Number	Frequency (MHz)	Attenuation Low Band	Attenuation High Band	Return Loss (min.)	Case Size
2450DP15E5400	2400 - 2500 4900 - 5900	0.70 dB max. 20 dB min.	17 dB min. 1.60 dB max.	9.5 dB 9.5 dB	Case 15-1B# # (opposite pin outs)
2450DP15D5400	2400 - 2500 4900 - 5900	0.70 dB max. 20 dB min.	19 dB min. 1.40 dB max.	9.5 dB 9.5 dB	Case 15-1B#
2450DP15F5400 (Prelim.)	2400 - 2500 4900 - 5900	0.70 dB max. 20 dB min.	19 dB min. 1.40 dB max.	9.5 dB 9.5 dB	Case 15-1D (Ultra Low Profile)

CERAMIC CHIP DIPLEXERS - OPTIMIZED FOR HARMONIC REJECTION

Part Number	Frequency (MHz)	Attenuation Low Band	Attenuation High Band	Return Loss (min.)	Case Size
0892DP14B1850	824 - 960 1710 - 1990	0.60 dB max. 15 dB min.	20 dB min. 0.90 dB max.	9.5 dB 9.5 dB	Case 14-1
0892DP15B1850	824 - 960 1710 - 1990	TBD dB max. TBD dB min.	TBD dB min. TBD dB max.	9.5 dB 9.5 dB	Case 15-1D
2400DP39B5425	2400 - 2500 4900 - 5900	2.50 dB min. 20 dB max.	17 dB max. 1.50 dB min.	9.5 dB 9.5 dB	Case 39-3B

Basic case size drawings for above part numbers are located on page 37.

Detailed specifications and performance curves for the RF Ceramic Component line are located on our website.

Case 07-1 (EIA 0402/ 1005)

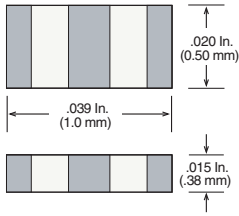

Case 14-1 (EIA 0603/ 1608)

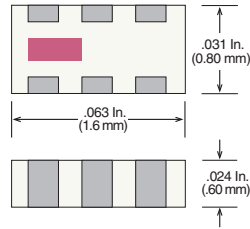

Case 15-1 (EIA 0805 / 2012)

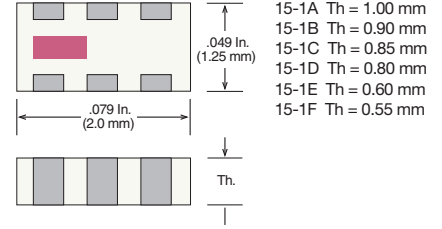

Case 15-2 (EIA 0805 / 2012)

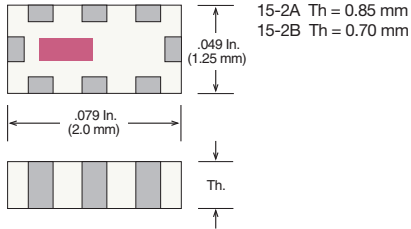

Case 15-3 (EIA 0805 / 2012)

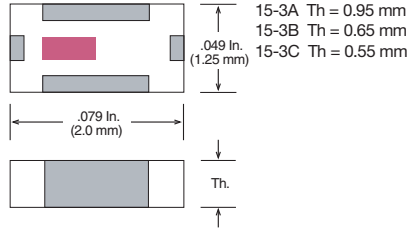

Case 15-4 (EIA 0805 / 2012)

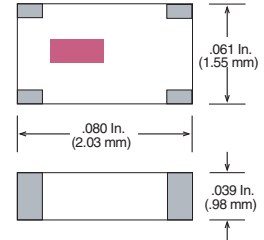

Case 18-1 (EIA 1206 / 3216)

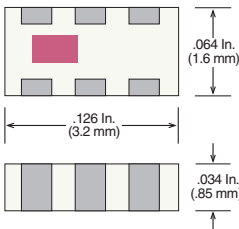

Case 18-2 (EIA 1206 / 3216)

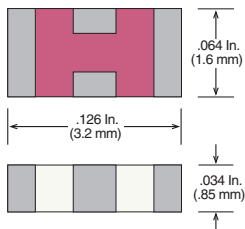

Case 18-3 (EIA 1206 / 3216)

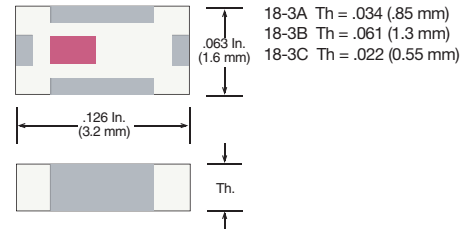

Case 18-4 (EIA 1206 / 3216)

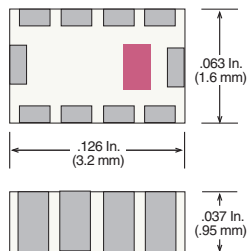

Case 39-1 (2025)

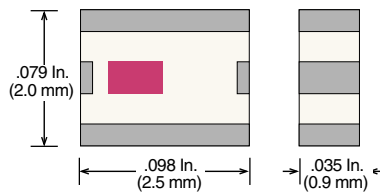

Case 39-2 (2025)

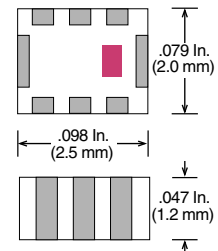

Case 39-3 (2025)

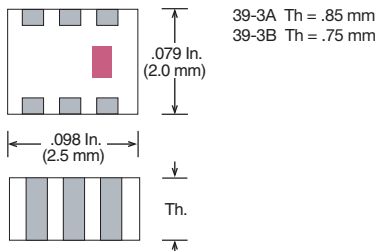

Case 41-1 (EIA 1210 / 3225)

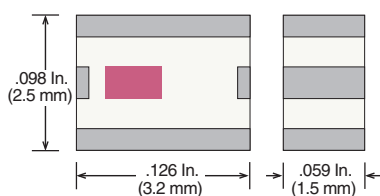

Case 41-2 (EIA 1210 / 3225)

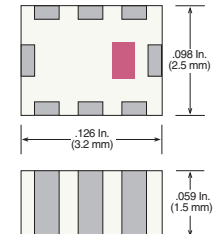

Detailed specifications and performance curves for the RF Ceramic Component line are located on our website.