

Low Noise, Low Power, SPI® Bus, 128 Taps, Wiper Only

The ISL22449 integrates four digitally controlled potentiometers (DCP) and non-volatile memory on a monolithic CMOS integrated circuit.

The digitally controlled potentiometers are implemented with a combination of resistor elements and CMOS switches. The position of the wipers are controlled by the user through the SPI serial interface. Each potentiometer has an associated volatile Wiper Register (WR) and a non-volatile Initial Value Register (IVR) that can be directly written to and read by the user. The contents of the WR controls the position of the wiper. At power-up the device recalls the contents of the DCP's IVR to the corresponding WR.

The DCP can be used as a voltage divider in a wide variety of applications including control, parameter adjustments, AC measurement and signal processing.

Pinout

ISL22449
(14 LD TSSOP)
TOP VIEW

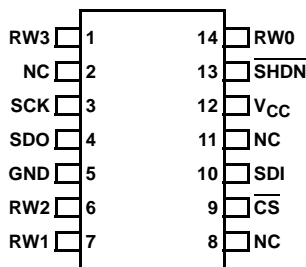

Features

- Four potentiometers in one package
- 128 resistor taps
- SPI serial interface
- Non-volatile storage of wiper position
- Wiper resistance: 70Ω typical
- Shutdown mode
- Shutdown current 6.5μA max
- Power supply: 2.7V to 5.5V
- 50kΩ or 10kΩ total resistance
- High reliability
 - Endurance: 1,000,000 data changes per bit per register
 - Register data retention: 50 years @ T ≤ +55°C
- 14 Lead TSSOP
- Pb-free plus anneal product (RoHS compliant)

Ordering Information

PART NUMBER	PART MARKING	RESISTANCE OPTION (kΩ)	TEMP. RANGE (°C)	PACKAGE	PKG. DWG. #
ISL22449UFV14Z (Notes 1, 2)	22449 UFVZ	50	-40 to +125	14 Ld TSSOP (Pb-free)	M14.173
ISL22449WV14Z (Notes 1, 2)	22449 WVZ	10	-40 to +125	14 Ld TSSOP (Pb-free)	M14.173

NOTES:

1. Intersil Pb-free plus anneal products employ special Pb-free material sets; molding compounds/die attach materials and 100% matte tin plate termination finish, which are RoHS compliant and compatible with both SnPb and Pb-free soldering operations. Intersil Pb-free products are MSL classified at Pb-free peak reflow temperatures that meet or exceed the Pb-free requirements of IPC/JEDEC J STD-020.
2. Add "-TK" suffix for 1,000 Tape and Reel option

Block Diagram

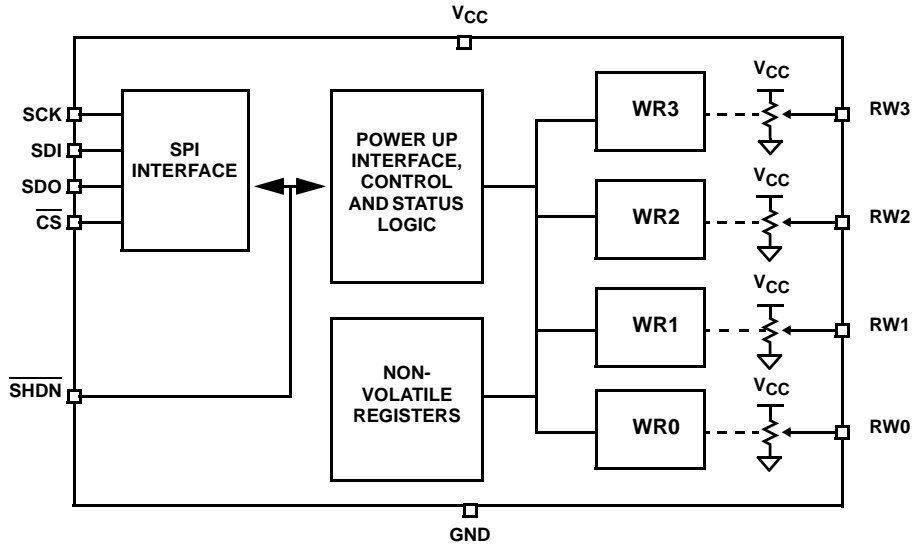

Pin Descriptions

TSSOP PIN	SYMBOL	DESCRIPTION
1	RW3	"Wiper" terminal of DCP3
2	NC	
3	SCK	SPI clock input
4	SDO	SPI open drain data output
5	GND	Device ground pin and the RL connection for each DCP
6	RW2	"Wiper" terminal of DCP2
7	RW1	"Wiper" terminal of DCP1
8	NC	
9	$\overline{\text{CS}}$	SPI Chip Select active low input
10	SDI	SPI data input
11	NC	
12	VCC	Power supply pin and the RH connection for each DCP
13	$\overline{\text{SHDN}}$	Shutdown active low input
14	RW0	"Wiper" terminal of DCP0

Absolute Maximum Ratings

Storage Temperature	-65°C to +150°C
Voltage at any Digital Interface Pin with Respect to GND	-0.3V to $V_{CC}+0.3$
V_{CC}	-0.3V to +6V
Voltage at any DCP pin with Respect to GND	-0.3V to V_{CC}
Lead Temperature (Soldering, 10s)	+300°C
I_W (10s)	±6mA
Latchup (Note 4)	Class II, Level B @ +125°C
ESD (HBM)	2.5kV
(CDM)	1kV

Thermal Information

Thermal Resistance (Typical, Note 3)	θ_{JA} (°C/W)
14 Ld TSSOP	+100
Maximum Junction Temperature (Plastic Package)	+150°C

Recommended Operating Conditions

Ambient Temperature	-40°C to +125°C
V_{CC} Voltage for DCP Operation	2.7V to 5.5V
Wiper Current	-3mA to 3mA
Power Rating	5mW

CAUTION: Stresses above those listed in "Absolute Maximum Ratings" may cause permanent damage to the device. This is a stress only rating and operation of the device at these or any other conditions above those indicated in the operational sections of this specification is not implied.

NOTES:

- θ_{JA} is measured with the component mounted on a high effective thermal conductivity test board in free air. See Tech Brief TB379 for details.
- Jedec Class II pulse conditions and failure criterion used. Level B exceptions are: using a max positive pulse of 6.5V on the SHDN pin, and using a max negative pulse of -0.8V for all pins.

Analog Specifications Over recommended operating conditions unless otherwise stated.

SYMBOL	PARAMETER	TEST CONDITIONS	MIN	TYP (NOTE 5)	MAX	UNIT
R_{TOTAL}	End-to-End resistance	W option		10		k Ω
		U option		50		k Ω
	End-to-End resistance tolerance	W and U option	-20		+20	%
	End-to-End Temperature Coefficient	W option			±50	
U option				±80		ppm/°C (Note 15)
R_W	Wiper resistance	$V_{CC} = 3.3V @ +25^\circ C$, wiper current = V_{CC}/R_{TOTAL}		70	200	Ω
C_W (Note 15)	Wiper capacitance			25		pF
VOLTAGE DIVIDER MODE (measured at R_{Wi} , unloaded; $i = 0, 1, 2$ or 3)						
INL (Note 10)	Integral non-linearity		-1		1	LSB (Note 6)
DNL (Note 9)	Differential non-linearity	Monotonic over all tap positions	-0.5		0.5	LSB (Note 6)
ZSerror (Note 7)	Zero-scale error	W option	0	1	5	LSB (Note 6)
		U option	0	0.5	2	
FSerror (Note 8)	Full-scale error	W option	-5	-1	0	LSB (Note 6)
		U option	-2	-1	0	
V_{MATCH} (Note 11)	DCP to DCP matching	Any two DCPs at same tap position	-2		2	LSB (Note 6)
TC_V (Note 12)	Ratiometric temperature coefficient	DCP register set to 40 hex		±4		ppm/°C

Operating Specifications Over the recommended operating conditions unless otherwise specified.

SYMBOL	PARAMETER	TEST CONDITIONS	MIN	TYP (NOTE 5)	MAX	UNIT
I _{CC1}	V _{CC} Supply Current (volatile write/read)	V _{CC} = +3.6V, 10k DCP, f _{SPI} = 5MHz; (for SPI active, read and write states)			2.5	mA
	V _{CC} Supply Current (volatile write/read)	V _{CC} = +3.6V, 50k DCP, f _{SPI} = 5MHz; (for SPI active, read and write states)			0.65	mA
I _{CC2}	V _{CC} Supply Current (non-volatile write/read)	V _{CC} = +5.5V, 10k DCP, f _{SPI} = 5MHz; (for SPI active, read and write states)			4.0	mA
	V _{CC} Supply Current (non-volatile write/read)	V _{CC} = +5.5V, 50k DCP, f _{SPI} = 5MHz; (for SPI active, read and write states)			3.0	mA
I _{SB}	V _{CC} Current (standby)	V _{CC} = +5.5V, 10k DCP, SPI interface in standby state			2.4	mA
		V _{CC} = +5.5V, 50k DCP, SPI interface in standby state			525	μA
		V _{CC} = +3.6V, 10k DCP, SPI interface in standby state			1.6	mA
		V _{CC} = +3.6V, 50k DCP, SPI interface in standby state			350	μA
I _{SD}	V _{CC} Current (shutdown)	V _{CC} = +5.5V @ +85°C, SPI interface in standby state			5	μA
		V _{CC} = +5.5V @ +125°C, SPI interface in standby state			6.5	μA
		V _{CC} = +3.6V @ +85°C, SPI interface in standby state			4	μA
		V _{CC} = +3.6V @ +125°C, SPI interface in standby state			5.5	μA
I _{LkgDig}	Leakage current, at pins $\overline{\text{SHDN}}$, SCK, SDI, SDO and $\overline{\text{CS}}$	Voltage at pin from GND to V _{CC}	-1		1	μA
t _{WRT} (Note 15)	DCP wiper response time	SCK falling edge of last bit of DCP data byte to wiper new position		1.5		μs
t _{ShdnRec} (Note 15)	DCP recall time from shutdown mode	From rising edge of $\overline{\text{SHDN}}$ signal to wiper stored position and RH connection		1.5		μs
		SCK rising edge of last bit of ACR data byte to wiper stored position and RH connection		1.5		μs
V _{por}	Power-on recall voltage	Minimum V _{CC} at which memory recall occurs	2.0		2.6	V
V _{ccRamp}	V _{cc} ramp rate		0.2			V/ms
t _D	Power-up delay	V _{CC} above V _{por} , to DCP Initial Value Register recall completed, and SPI Interface in standby state			3	ms

EEPROM SPECIFICATION

	EEPROM Endurance		1,000,000			Cycles
	EEPROM Retention	Temperature T ≤ +55°C	50			Years
t _{WC} (Note 13)	Non-volatile Write cycle time			12	20	ms

SERIAL INTERFACE SPECIFICATIONS

V _{IL}	$\overline{\text{SHDN}}$, SCK, SDI, and $\overline{\text{CS}}$ input buffer LOW voltage		-0.3		0.3*V _{CC}	V
V _{IH}	$\overline{\text{SHDN}}$, SCK, SDI, and $\overline{\text{CS}}$ input buffer HIGH voltage		0.7*V _{CC}		V _{CC} +0.3	V

Operating Specifications Over the recommended operating conditions unless otherwise specified. (Continued)

SYMBOL	PARAMETER	TEST CONDITIONS	MIN	TYP (NOTE 5)	MAX	UNIT
Hysteresis	$\overline{\text{SHDN}}$, SCK, SDI, and $\overline{\text{CS}}$ input buffer hysteresis		0.05* V_{CC}			V
V_{OL}	SDO output buffer LOW voltage	$I_{OL} = 4\text{mA}$	0		0.4	V
R_{pu} (Note 14)	SDO pull-up resistor off-chip	Maximum is determined by t_{RO} and t_{FO} with maximum bus load $C_{bus} = 30\text{pF}$, $f_{SCK} = 5\text{MHz}$			2	k Ω
C_{pin} (Note 15)	$\overline{\text{SHDN}}$, SCK, SDI, SDO and $\overline{\text{CS}}$ pin capacitance				10	pF
f_{SCK}	SPI frequency				5	MHz
t_{CYC}	SPI clock cycle time		200			ns
t_{WH}	SPI clock high time		100			ns
t_{WL}	SPI clock low time		100			ns
t_{LEAD}	Lead time		250			ns
t_{LAG}	Lag time		250			ns
t_{SU}	SDI, SCK and $\overline{\text{CS}}$ input setup time		50			ns
t_H	SDI, SCK and $\overline{\text{CS}}$ input hold time		50			ns
t_{RI}	SDI, SCK and $\overline{\text{CS}}$ input rise time		10			ns
t_{FI}	SDI, SCK and $\overline{\text{CS}}$ input fall time		10		20	ns
t_{DIS}	SDO output Disable time		0		100	ns
t_V	SDO output valid time				350	ns
t_{HO}	SDO output hold time		0			ns
t_{RO}	SDO output rise time	$R_{pu} = 2\text{k}$, $C_{bus} = 30\text{pF}$			60	ns
t_{FO}	SDO output fall time	$R_{pu} = 2\text{k}$, $C_{bus} = 30\text{pF}$			60	ns
t_{CS}	CS deselect time		2			μs
t_{WRT}	Wiper Response Time after SPI write to WR register				1.5	μs

NOTES:

- Typical values are for $T_A = +25^\circ\text{C}$ and 3.3V supply voltage.
- LSB: $[V(RW)_{127} - V(RW)_0]/127$. $V(RW)_{127}$ and $V(RW)_0$ are $V(RW)$ for the DCP register set to 7F hex and 00 hex respectively. LSB is the incremental voltage when changing from one tap to an adjacent tap.
- ZS error = $V(RW)_0/\text{LSB}$.
- FS error = $[V(RW)_{127} - V_{CC}]/\text{LSB}$.
- DNL = $[V(RW)_i - V(RW)_{i-1}]/\text{LSB} - 1$, for $i = 1$ to 127. i is the DCP register setting.
- INL = $[V(RW)_i - i \cdot \text{LSB} - V(RW)]/\text{LSB}$ for $i = 1$ to 127
- $V_{MATCH} = [V(RW_x)_i - V(RW_y)_i]/\text{LSB}$, for $i = 1$ to 127, $x = 0$ to 3 and $y = 0$ to 3.
- $TC_V = \frac{\text{Max}(V(RW)_i) - \text{Min}(V(RW)_i)}{[\text{Max}(V(RW)_i) + \text{Min}(V(RW)_i)]/2} \times \frac{10^6}{165^\circ\text{C} - (-40^\circ\text{C})}$ for $i = 16$ to 112 decimal, $T = -40^\circ\text{C}$ to $+125^\circ\text{C}$. $\text{Max}()$ is the maximum value of the wiper voltage and $\text{Min}()$ is the minimum value of the wiper voltage over the temperature range.
- t_{WC} is the time from the end of a Write sequence of SPI serial interface, to the end of the self-timed internal non-volatile write cycle.
- R_{pu} is specified for the highest data rate transfer for the device. Higher value pullup can be used at lower data rates.
- This parameter is not 100% tested.

Timing Diagrams

Input Timing

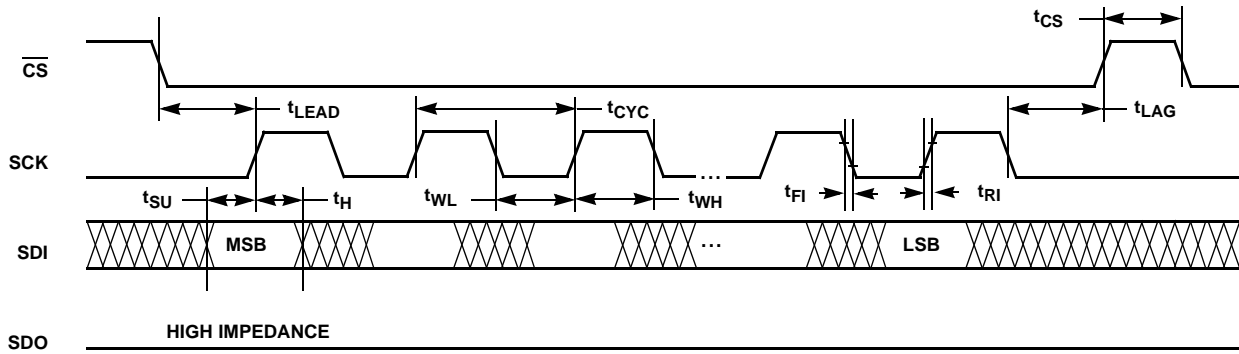

Output Timing

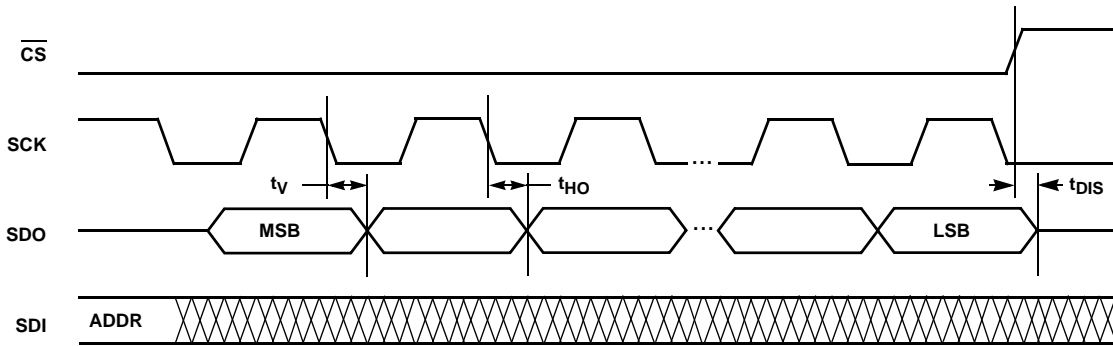

XDCP Timing (for All Load Instructions)

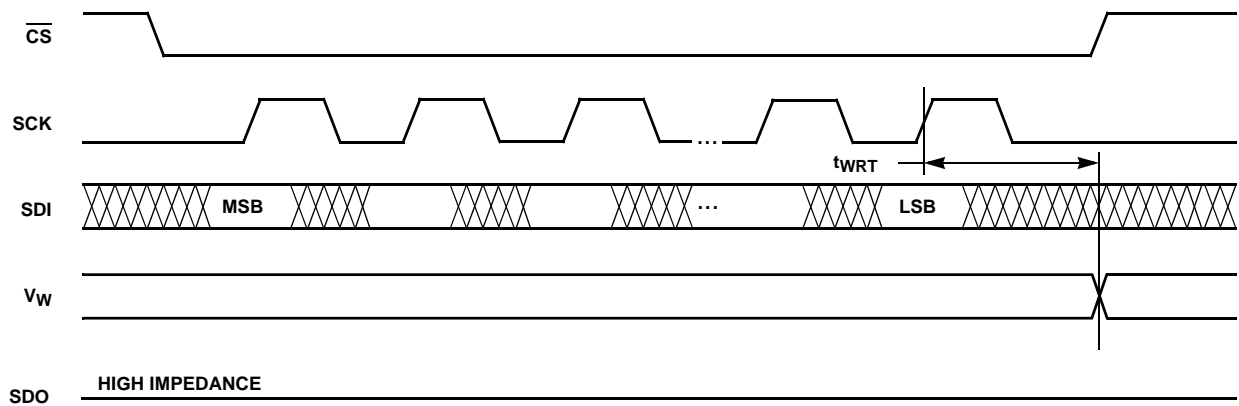

Typical Performance Curves

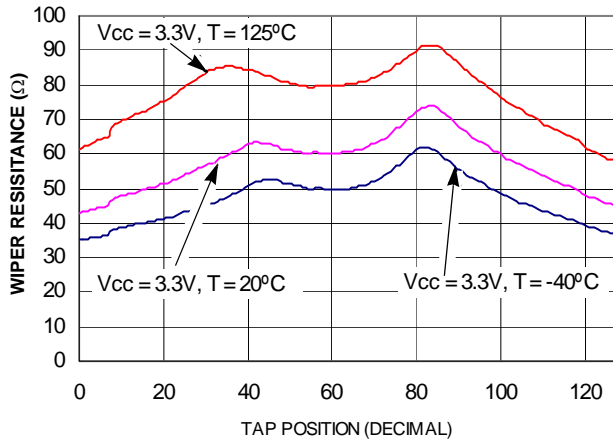

FIGURE 1. WIPER RESISTANCE vs TAP POSITION [(RW) = VCC/RTOTAL] FOR 10kΩ (W)

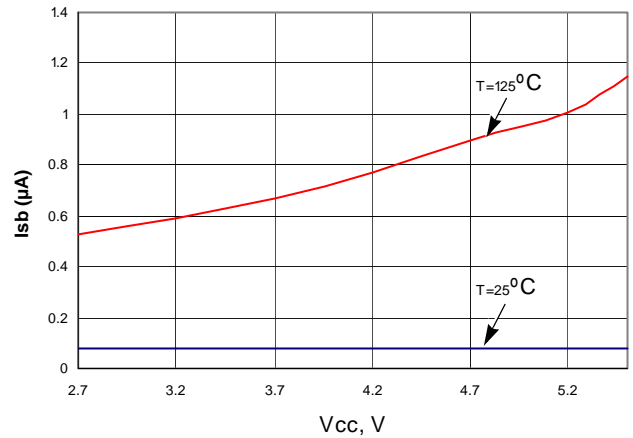

FIGURE 2. STANDBY ICC vs VCC

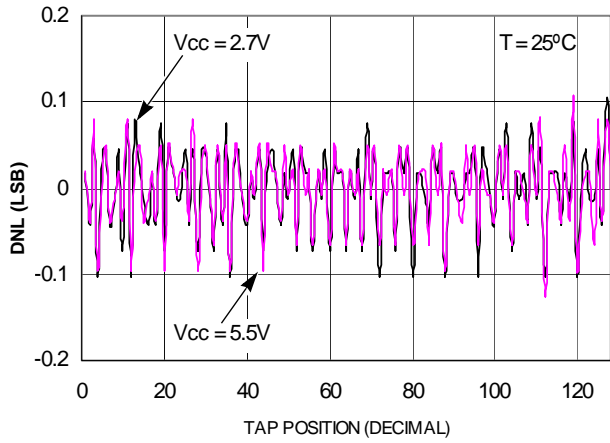

FIGURE 3. DNL vs TAP POSITION IN VOLTAGE DIVIDER MODE FOR 10kΩ (W)

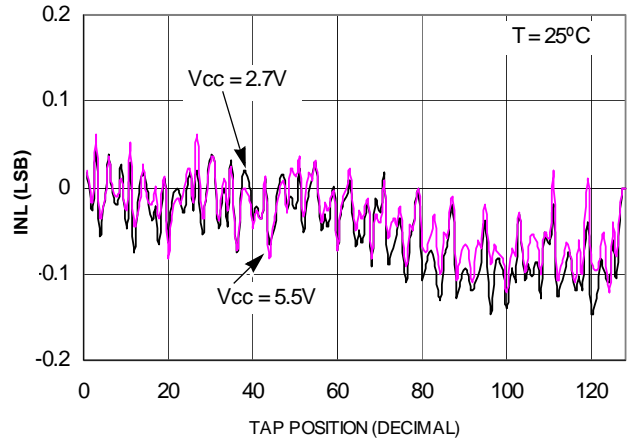

FIGURE 4. INL vs TAP POSITION IN VOLTAGE DIVIDER MODE FOR 10kΩ (W)

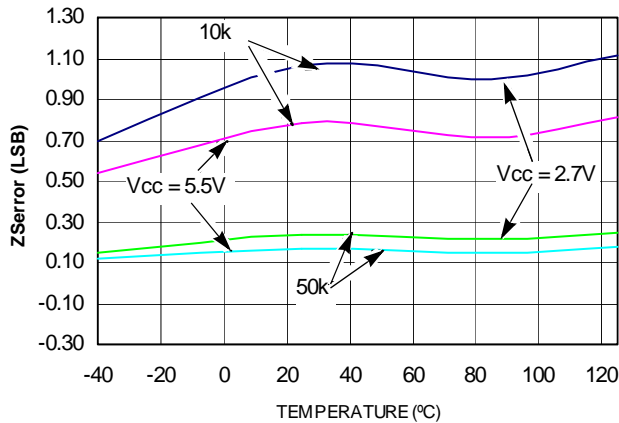

FIGURE 5. ZSerror vs TEMPERATURE

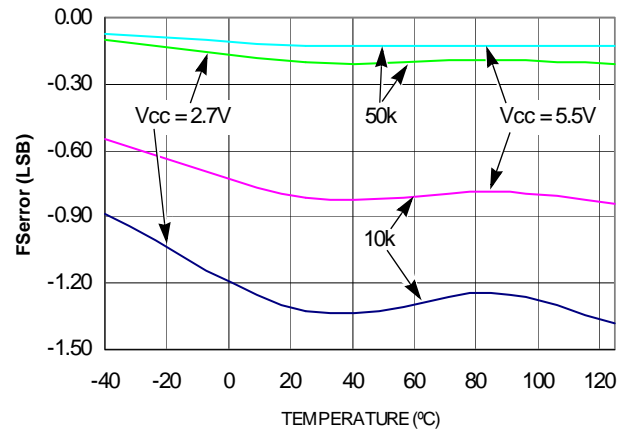

FIGURE 6. FSerror vs TEMPERATURE

Typical Performance Curves (Continued)

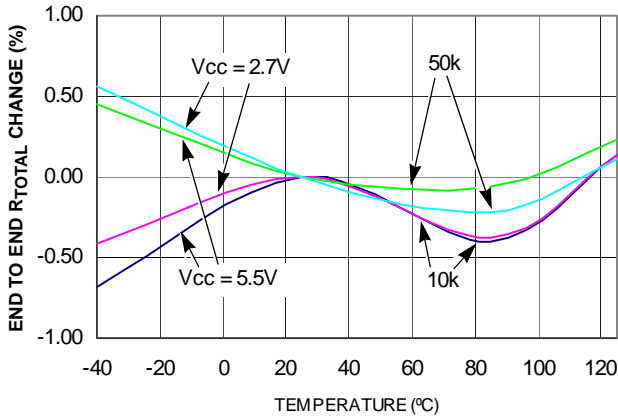

FIGURE 7. END TO END R_{TOTAL} % CHANGE vs TEMPERATURE

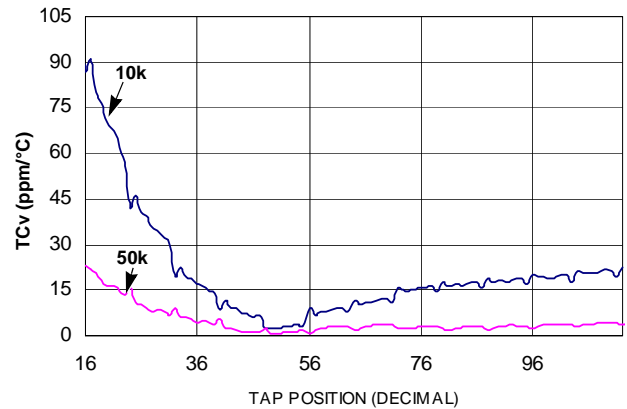

FIGURE 8. TC FOR VOLTAGE DIVIDER MODE IN ppm

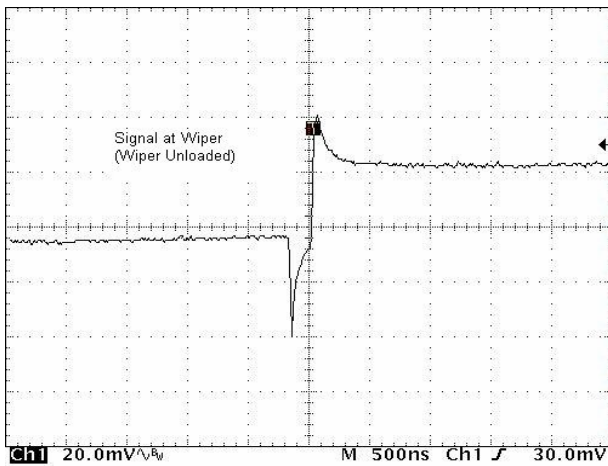

FIGURE 9. MIDSCALE GLITCH, CODE 80h TO 7Fh

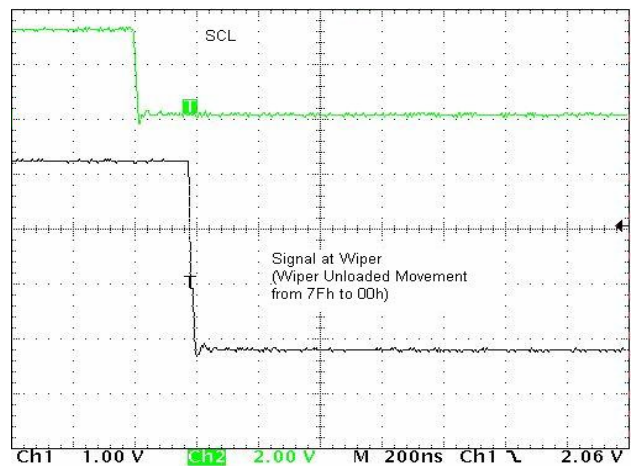

FIGURE 10. LARGE SIGNAL SETTLING TIME

Pin Description

Potentiometers Pins

RW_i (i = 0, 1, 2, 3)

RW_i is the wiper terminal and is equivalent to the movable terminal of a mechanical potentiometer. The position of the wiper within the array is determined by the WR_i register.

SHDN

The SHDN pin forces the resistors to end-to-end open circuit condition and shorts all RW_s to GND. When SHDN is returned to logic high, the previous latch settings put RW_i at the same resistance setting prior to shutdown. This pin is logically OR'd with SHDN bit in ACR register. SPI interface is still available in shutdown mode and all registers are accessible. This pin must remain HIGH for normal operation.

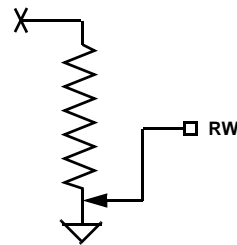

FIGURE 11. DCP CONNECTION IN SHUTDOWN MODE

Bus Interface Pins

Serial Clock (SCK)

This is the serial clock input of the SPI serial interface.

Serial Data Output (SDO)

The SDO is an open drain serial data output pin. During a read cycle, the data bits are shifted out at the falling edge of the serial clock SCK, while the \overline{CS} input is low.

SDO requires an external pull-up resistor for proper operation.

Serial Data Input (SDI)

The SDI is the serial data input pin for the SPI interface. It receives device address, operation code, wiper address and data from the SPI external host device. The data bits are shifted in at the rising edge of the serial clock SCK, while the \overline{CS} input is low.

Chip Select (CS)

\overline{CS} LOW enables the ISL22449, placing it in the active power mode. A HIGH to LOW transition on \overline{CS} is required prior to the start of any operation after power up. When \overline{CS} is HIGH, the ISL22449 is deselected and the SDO pin is at high impedance, and (unless an internal write cycle is underway) the device will be in the standby state.

Principles of Operation

The ISL22449 is an integrated circuit incorporating four DCPs with its associated registers, non-volatile memory and the SPI serial interface providing direct communication between host and potentiometers and memory. The resistor array is comprised of individual resistors connected in series. At either end of the array and between each resistor is an electronic switch that transfers the potential at that point to the wiper.

The electronic switches on the device operate in a “make before break” mode when the wiper changes tap positions.

When the device is powered down, the last value stored in IVR_i will be maintained in the non-volatile memory. When power is restored, the contents of the IVR_i is recalled and loaded into the corresponding WR_i to set the wiper to the initial value.

DCP Description

Each DCP is implemented with a combination of resistor elements and CMOS switches. The physical ends of each DCP are equivalent to the fixed terminals of a mechanical potentiometer and internally connected to V_{CC} and GND. The RW pin of each DCP is connected to intermediate nodes, and is equivalent to the wiper terminal of a mechanical potentiometer. The position of the wiper terminal within the DCP is controlled by volatile Wiper Register (WR). Each DCP has its own WR. When the WR of a DCP contains all zeroes (WR[6:0]= 00h), its wiper terminal (RW) is closest to GND. When the WR register of a DCP contains all ones (WR[6:0]= 7Fh), its wiper terminal (RW) is closest to V_{CC}. As the value of the WR increases from all zeroes (0) to all ones (127 decimal), the wiper moves monotonically from the position closest to GND to the closest to V_{CC}.

While the ISL22449 is being powered up, all four WRs are reset to 40h (64 decimal), which locates RW roughly at the center between GND and V_{CC}. After the power supply voltage becomes large enough for reliable non-volatile memory reading, all WRs will be reload with the value stored in corresponding non-volatile Initial Value Registers (IVRs).

The SPI interface register address bits have to be set to 0000b, 0001b, 0010b or 0011b to access the WR of DCP0, DCP1, DCP2 or DCP3 respectively. The WR_i and IVR_i can be read or written to directly using the SPI serial interface as described in the following sections.

Memory Description

The ISL22449 contains seven non-volatile and five volatile 8-bit registers. The memory map of ISL22449 is on Table 1. The four non-volatile registers (IVR_i) at address 0, 1, 2 and 3, contain initial wiper value and volatile registers (WR_i) contain current wiper position. In addition, three non-volatile General Purpose registers from address 4 to address 6 are available.

TABLE 1. MEMORY MAP

ADDRESS	NON-VOLATILE	VOLATILE
8	—	ACR
7	Reserved	
6	General Purpose	Not Available
5	General Purpose	Not Available
4	General Purpose	Not Available
3	IVR3	WR3
2	IVR2	WR2
1	IVR1	WR1
0	IVR0	WR0

The non-volatile IVR_i and volatile WR_i registers are accessible with the same address.

The Access Control Register (ACR) contains information and control bits described below in Table 2.

The VOL bit (ACR[7]) determines whether the access is to wiper registers WR or initial value registers IVR.

TABLE 2. ACCESS CONTROL REGISTER (ACR)

BIT #	7	6	5	4	3	2	1	0
Bit Name	VOL	SHDN	WIP	0	0	0	0	0

If VOL bit is 0, the non-volatile IVR register is accessible. If VOL bit is 1, only the volatile WR_i is accessible. Note, value is written to IVR_i register also is written to the WR_i. The default value of this bit is 0.

The SHDN bit (ACR[6]) disables or enables Shutdown mode. This bit is logically OR'd with \overline{SHDN} pin. When this bit is 0, DCPs are in Shutdown mode. Default value of SHDN bit is 1.

The WIP bit (ACR[5]) is read only bit. It indicates that non-volatile write operation is in progress. The WIP bit can be

read repeatedly after a non-volatile write to determine if the write has been completed. It is impossible to write to the IVR_i, WR_i or ACR while WIP bit is 1.

SPI Serial Interface

The ISL22449 supports an SPI serial protocol, mode 0. The device is accessed via the SDI input and SDO output with data clocked in on the rising edge of SCK, and clocked out on the falling edge of SCK. \overline{CS} must be LOW during communication with the ISL22449. SCK and \overline{CS} lines are controlled by the host or master. The ISL22449 operates only as a slave device.

All communication over the SPI interface is conducted by sending the MSB of each byte of data first.

Protocol Conventions

The first byte sent to the ISL22449 from the SPI host is the Identification Byte. A valid Identification Byte contains 0101 as the four MSBs, with the following four bits set to 0.

TABLE 3. IDENTIFICATION BYTE FORMAT

0	1	0	1	0	0	0	0
(MSB)				(LSB)			

The next byte sent to the ISL22449 contains the instruction and register pointer information. The four MSBs are the instruction and four LSBs are register address (see Table 4).

TABLE 4. IDENTIFICATION BYTE FORMAT

7	6	5	4	3	2	1	0
I3	I2	I1	I0	R3	R2	R1	R0

There are only two valid instruction sets:

1011(binary) - is a Read operation

1100(binary) - is a Write operation

Write Operation

A Write operation to the ISL22449 is a three-byte operation. It requires first, the CS transition from HIGH to LOW, then a

valid Identification Byte, then a valid instruction byte following by Data Byte is sent to SDI pin. The host terminates the write operation by pulling the \overline{CS} pin from LOW to HIGH. For a write to addresses 0000b to 0011b, the MSB at address 8 (ACR[7]) determines if the Data Byte is to be written to volatile or both volatile and non-volatile registers. Refer to “Memory Description” and Figure 12.

Device can receive more than one byte of data by auto incrementing the address after each received byte. Note after reaching the address 0110b, the internal pointer “rolls over” to address 0000b.

The internal non-volatile write cycle starts after rising edge of \overline{CS} and takes up to 20ms. Thus, non-volatile registers must be written individually.

Read Operation

A read operation to the ISL22449 is a three-byte operation. It requires first, the \overline{CS} transition from HIGH to LOW, then a valid Identification Byte, then a valid instruction byte following by “dummy” Data Byte is sent to SDI pin. The SPI host reads the data from SDO pin on falling edge of SCK. The host terminates the read operation by pulling the \overline{CS} pin from LOW to HIGH (see Figure 13).

The ISL22449 will provide the Data Bytes to the SDO pin as long as SCK is provided by the host from the registers indicated by an internal pointer. This pointer initial value is determined by the register address in the Read operation instruction, and increments by one during transmission of each Data Byte. After reaching the memory location 0110b, the pointer “rolls over” to 0000b, and the device continues to output the data for each received SCK clock.

In order to read back the non-volatile IVR, it is recommended that the application reads the ACR first to verify the WIP bit is 0. If the WIP bit (ACR[5]) is not 0, the host should repeat its reading sequence again.

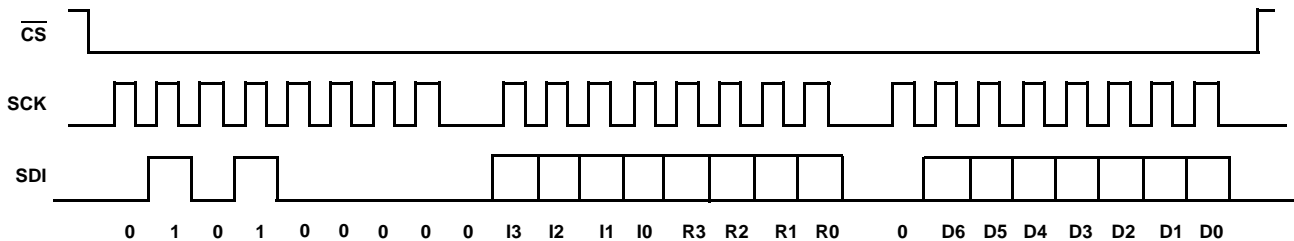

FIGURE 12. THREE BYTE WRITE SEQUENCE

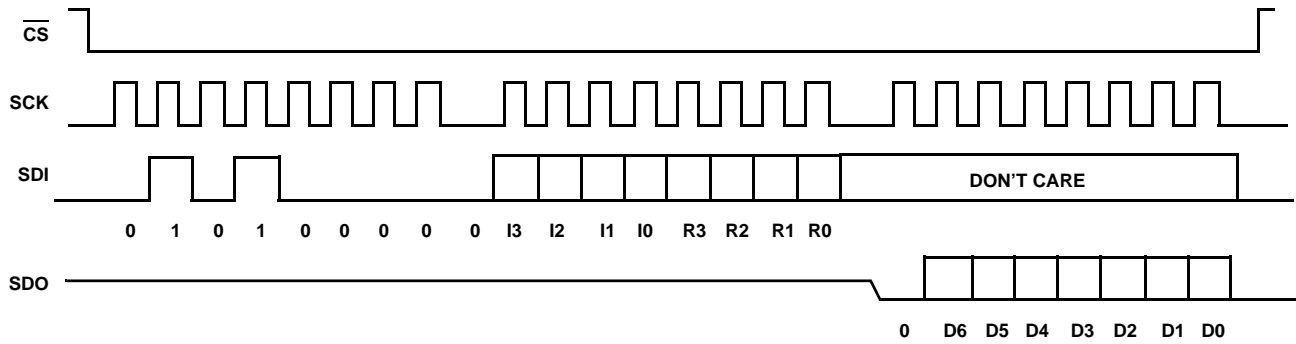

FIGURE 13. THREE BYTE READ SEQUENCE

Applications Information

Communicating with ISL22449

Communication with ISL22449 proceeds using SPI interface through the ACR (address 1000b), IVRi (addresses 0000b, 0001b, 0010b and 0011b) and WRi (addresses 0000b, 0001b, 0010b and 0011b) registers.

The wiper of the potentiometer is controlled by the WRi register. Writes and reads can be made directly to these registers to control and monitor the wiper position without

any non-volatile memory changes. This is done by setting MSB bit at address 1000b to 1.

The non-volatile IVRi stores the power up value of the wiper. IVRi are accessible when MSB bit at address 1000b is set to 0. Writing a new value to the IVRi register will set a new power up position for the wiper. Also, writing to this register will load the same value into the corresponding WRi as the IVRi. Reading from the IVRi will not change the WRi, if its contents are different.

Examples:

A. Writing to the IVR:

This sequence will write a new value (77h) to the IVR2(non-volatile):

Set the ACR (Addr 1000b) for NV write (40h)

Send the ID byte, Instruction Byte, then the Data byte

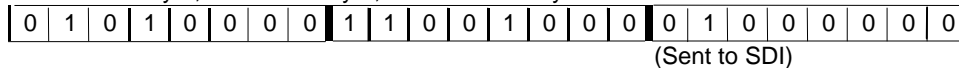

Set the IVR (Addr 0010b) to 77h

Send the ID byte, Instruction Byte, then the Data byte

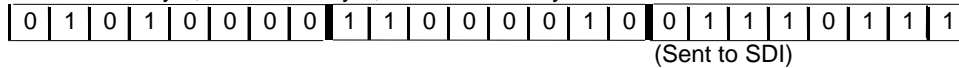

B. Reading from the WR:

This sequence will read the value from the WR3 (volatile):

Write to ACR first to access the volatile WRs

Send the ID byte, Instruction Byte, then the Data byte

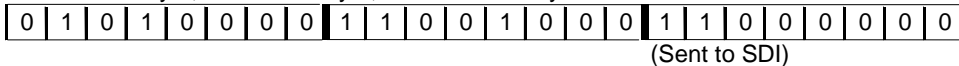

Read the data from WR3 (Addr 0011b)

Send the ID byte, Instruction Byte, then Read the Data byte

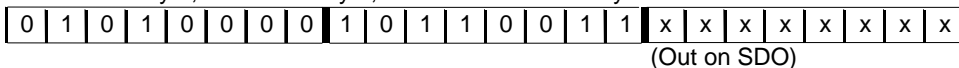

Thin Shrink Small Outline Plastic Packages (TSSOP)

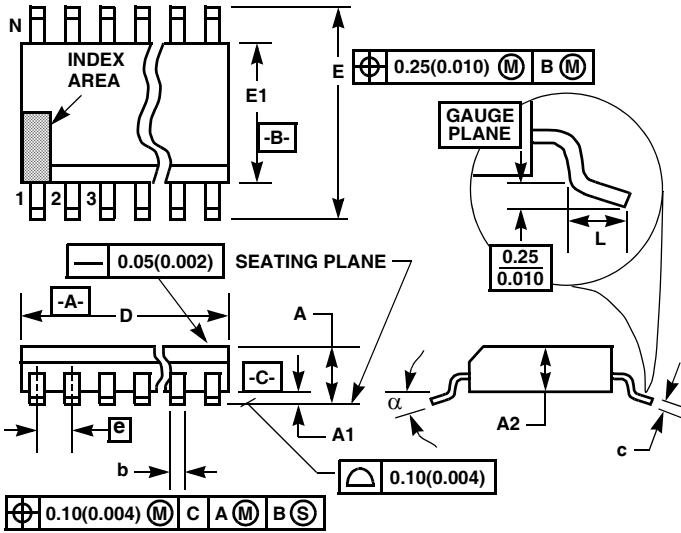

M14.173
14 LEAD THIN SHRINK SMALL OUTLINE PLASTIC PACKAGE

SYMBOL	INCHES		MILLIMETERS		NOTES
	MIN	MAX	MIN	MAX	
A	-	0.047	-	1.20	-
A1	0.002	0.006	0.05	0.15	-
A2	0.031	0.041	0.80	1.05	-
b	0.0075	0.0118	0.19	0.30	9
c	0.0035	0.0079	0.09	0.20	-
D	0.195	0.199	4.95	5.05	3
E1	0.169	0.177	4.30	4.50	4
e	0.026 BSC		0.65 BSC		-
E	0.246	0.256	6.25	6.50	-
L	0.0177	0.0295	0.45	0.75	6
N	14		14		7
α	0°	8°	0°	8°	-

NOTES:

- These package dimensions are within allowable dimensions of JEDEC MO-153-AC, Issue E.
- Dimensioning and tolerancing per ANSI Y14.5M-1982.
- Dimension "D" does not include mold flash, protrusions or gate burrs. Mold flash, protrusion and gate burrs shall not exceed 0.15mm (0.006 inch) per side.
- Dimension "E1" does not include interlead flash or protrusions. Interlead flash and protrusions shall not exceed 0.15mm (0.006 inch) per side.
- The chamfer on the body is optional. If it is not present, a visual index feature must be located within the crosshatched area.
- "L" is the length of terminal for soldering to a substrate.
- "N" is the number of terminal positions.
- Terminal numbers are shown for reference only.
- Dimension "b" does not include dambar protrusion. Allowable dambar protrusion shall be 0.08mm (0.003 inch) total in excess of "b" dimension at maximum material condition. Minimum space between protrusion and adjacent lead is 0.07mm (0.0027 inch).
- Controlling dimension: MILLIMETER. Converted inch dimensions are not necessarily exact. (Angles in degrees)

Rev. 2 4/06

All Intersil U.S. products are manufactured, assembled and tested utilizing ISO9000 quality systems. Intersil Corporation's quality certifications can be viewed at www.intersil.com/design/quality

Intersil products are sold by description only. Intersil Corporation reserves the right to make changes in circuit design, software and/or specifications at any time without notice. Accordingly, the reader is cautioned to verify that data sheets are current before placing orders. Information furnished by Intersil is believed to be accurate and reliable. However, no responsibility is assumed by Intersil or its subsidiaries for its use; nor for any infringements of patents or other rights of third parties which may result from its use. No license is granted by implication or otherwise under any patent or patent rights of Intersil or its subsidiaries.

For information regarding Intersil Corporation and its products, see www.intersil.com