

# CERAMIC DISC CAPACITORS 1.0 PICOFARAD TO 0.1 MICROFARAD

Reliable Solutions in EMI/RFI, Decoupling, dv/dt & di/dt, Snubbers, By-Pass, ESR & ESL.  
Excellent for Power Supplies: Switcher & High Voltage.

Metallurgically bonded lead attachment for reliability under severe thermal cycling.

Silver electrodes minimize aging and are time proven for stability.

Solid ceramic discs provide maximum resistance to failure from voltage transients and current surges, good power dissipation, and heat sinking.

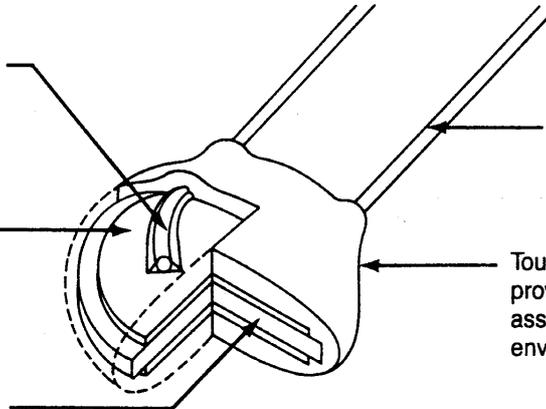

Tinned copper leads for optimum soldering.

Tough polymer insulating coating provides mechanical strength for assembly and extended-life environment protection.

## MARKING INFORMATION

Leaded type, DC rated, disc capacitors are marked with a code that identifies the manufacturer, capacitance, tolerance, voltage, and type of ceramic.

Specialty types such as AC rated are marked as described in those sections.

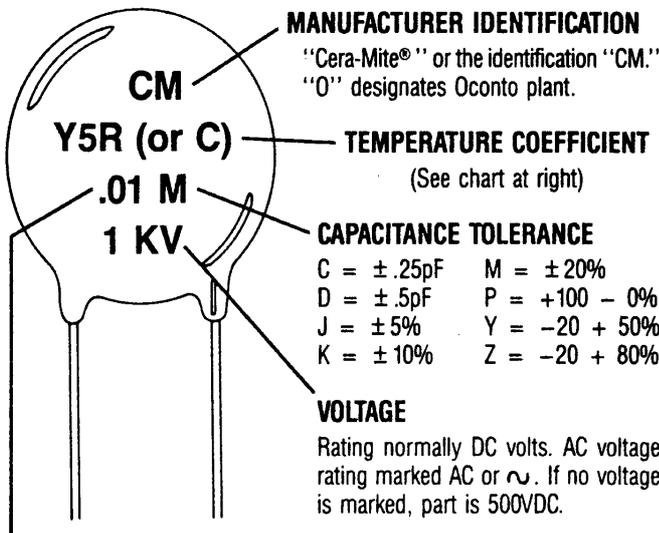

### CAPACITANCE

Expressed in picofarads or microfarads.  
Examples: 680 = 680 picofarads.  
0047 = .0047 microfarads.

### OPTIONAL MARKINGS

A Lot Date Code and/or a Customer Part Number may also be imprinted on the capacitor, at extra cost.

## TYPE OF CERAMIC (Temperature Coefficient)

Capacitance Change Over Temp. Range PPM per Degree C	Marking Code for Temp. Range -55° to +125°C	Alternate Marking Code	Dielectric Class			
0 ± 30 (NPO)	COG	A	I			
-750 ± 120 (N750)	U2J	U	I			
-1000 ± 250 (N1000)	M3K	V	I			
-1500 ± 250 (N1500)	P3K	W	I			
-2200 ± 500 (N2200)	R3L	X	I			
-3300 ± 500 (N3300)	S3L	Y	I			
-4700 ± 1000 (N4700)	T3M	Z	I & II*			
Max. % Change	+10° +85°C	-30° +85°C	-55° +85°C	-55° +125°C		
± 7.5%	—	—	X5F	X7F	B	II
± 10%	—	Y5P	—	—	C	II
± 15%	—	Y5R	X5R	X7R	C	II or IV**
± 22%	—	Y5S	X5S	—	D	II or IV
+ 22 - 56%	Z5U	Y5U	—	—	E	III
+ 22 - 82%	Z5V	Y5V	—	—	F	III

\*N4700 is a transition material between Class I and II, and has characteristics of both. It is used for larger cap values; capacitance and DF measured at 1 kHz.

\*\*Class IV uses same material as Class II, but is processed differently.

# PACKAGING INFORMATION

## BULK

Bulk packaging is cardboard boxes. The inner box size will be either 6"x6"x2" or 6"x6"x3.5".

The boxes are labeled with the following:

Customer Name	Cera-Mite Mfg. Code Number	Qty.
Customer P.O. Number		
Cera-Mite P/N	Cera-Mite Lot Number	
Customer P/N		
Customer P/N Revision	Cera-Mite Order Number	
Cera-Mite Corp.	Grafton, WI 53024	

The outer carton standard packaging is corrugated cardboard, ranging in size from 6.5"x7"x8" to 12.5"x15"x7".

The cartons are labeled with the following:

Cera-Mite Corporation 1327 6th Avenue Grafton, WI 53024			
Customer P.O. Number	Customer P/N	Quantity	Box ____ of ____
Customer Name			
Customer Address			

## TAPE AND REEL (EIA-468-A)

ITEM	CODE	EIA OPTIONS			
		Fig. a 5mm LS	Fig. b 7.5mm LS 15mm Pitch	Fig. c 10mm LS	Fig. d 7.5mm LS 30mm Pitch
Pitch of component	P	12.7	15.0	25.4	30.0
Pitch of sprocket hole	P <sub>0</sub>	12.7 ± 0.3	15.0 ± 0.3	12.7 ± 0.3	15.0 ± 0.3
Lead spacing	F	5.0 + 0.8 - 0.2	7.5 ± 1.0	10.0 ± 1.0	7.5 ± 1.0
Length from hole center to component center	P <sub>2</sub>	6.35 ± 1.3	7.5 ± 1.5	—	7.5 ± 1.5
Length from hole center to lead	P <sub>1</sub>	3.85 ± 0.7	3.75 ± 1.0	7.7 ± 1.5	3.75 ± 1.0
Body diameter	D	See individual product specification			
Deviation along tape, left or right	ΔS	0 ± 1.3	0 ± 2.0		
Carrier tape width	W	18.0 ± 0.5			
Position of sprocket hole	W <sub>1</sub>	9.0 ± 0.5			
Lead distance between reference and bottom planes	H	20.0 + 1.5 - 1.0	20.0 + 1.5 - 1.0	18.0 + 2.0 - 0	20.0 + 1.5 - 1.0
Protusion length	l	+ 3.0 / - 1.0			
Diameter of sprocket hole	D <sub>0</sub>	4.0 ± 0.2			
Total tape thickness	t <sub>1</sub>	0.6 ± 0.3			
Total thickness, tape and lead wire	t <sub>2</sub>	1.5 max.			
Portion to cut in case of defect	L	11 max.			
Hold down tape width	W <sub>0</sub>	11.5 min.			
Hold down tape position	W <sub>2</sub>	1.5 ± 1.5			

The EIA lead spacings for tape and reel are based on multiples of .100" (2.5mm) to coordinate with standard automatic insertion machinery and boards using the .100" grid convention.

Many North American assemblers use .250" and .375" lead spacing for boards laid out for hand insertion or semi-automatic insertion such as Ragen machines. If capacitors are to be tape and reel with .250" or .375" LS, we recommend the style shown in Figure b or c.

For capacitors up to 3 KVDC, ≤12.4mm dia.  
12.7mm pitch/lead spacing 5mm

Figure a

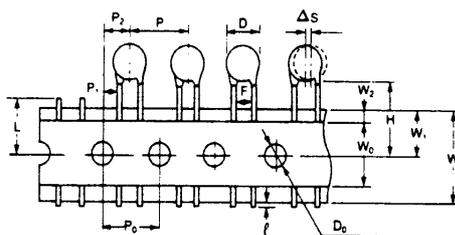

\*For standard Tape and Reel packaging of crimped leaded parts, "H" is measured to the bottom of the built-in standoff on the component leads. This dimension is 16mm ± 0.5.

For capacitors up to 12.4mm dia.  
15mm pitch/lead spacing 7.5mm

Figure b

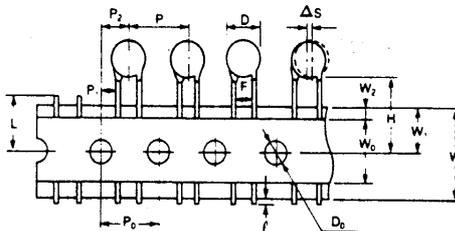

For capacitors ≥ 2 KVDC & AC rated, ≤18mm  
25.4mm pitch/lead spacing 10.0mm

Figure c

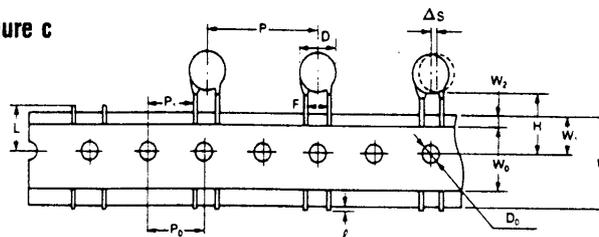

For capacitors ≥ 2 KVDC & AC rated, ≤18mm dia.  
30mm pitch/lead spacing 7.5mm

Figure d

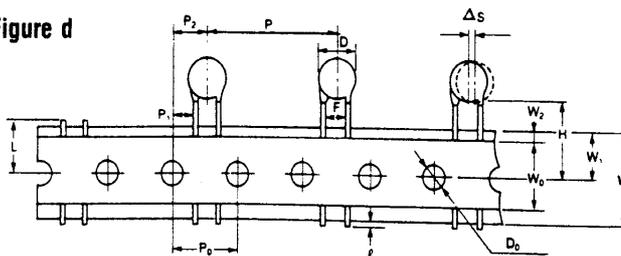

# CERAMIC DISC CAPACITOR APPLICATION NOTES

- **HIGH K:** For small size and higher values of capacitance. EIA 198D Class III, Z5U, Y5U, Y5V. This type is usually broad tolerance:  $\pm 20\%$  or  $+80 - 20\%$ .
- **MODERATELY HIGH K:** Here the materials are blended to provide better capacitance stability against change in temperature or voltage; but may be larger in size than the HIGH K types, especially in the higher capacitance values. EIA 198D Class II, X5F, X7R, X7S. Usually tighter tolerance.  $\pm 10\%$  at  $25^\circ\text{C}$ . Higher dv/dt rating.
- **LOW K FORMULATIONS FOR PRECISION CAPACITORS:** This class provides ultra stable capacitance over the broadest temperature, frequency ranges and voltage variation. EIA Class I, NPO, U2J, R3L and S3L. Usually  $\pm 5\%$  or better. Highest dv/dt rating.

- **HYPERCON** construction gives the highest capacitance density for larger values. This type is made by forming a dielectric barrier layer at each electrode surface and connecting these layers through the titanate substrate. The thin dielectric layer produces very high capacitance and good temperature stability. Improvements have extended the range of application to 100 VDC rating. Industry standard EIA 198D Class IV, Y5R and Y5S.
- **CAPACITANCE MEASUREMENTS:** Class IV dielectric are conducted at 50 to 100 millivolts, 1000 hz. All others are measured at 1.0 volts; Class II & III at 1 khz; Class I at 1 mhz.

EFFECTIVE CAP CHANGE vs. FREQUENCY

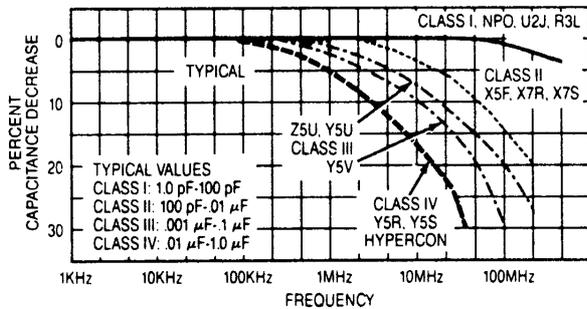

CAPACITANCE CHANGE vs. TEMPERATURE

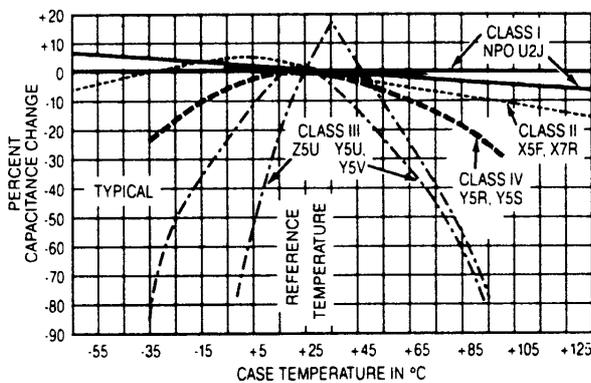

CAPACITANCE DECREASE vs. D-C VOLTAGE BIAS

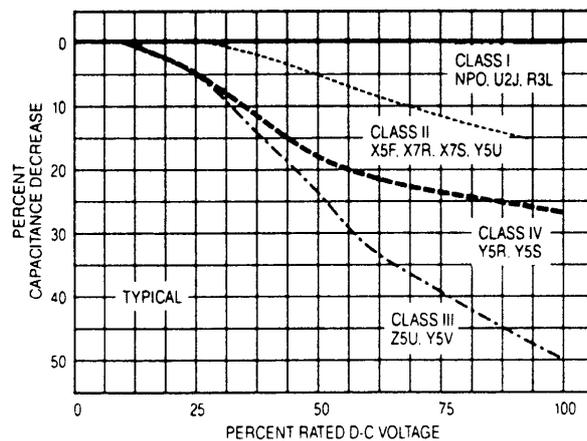

**FREQUENCY:**

- Operating frequency range is determined primarily by capacitor value and self resonance due to lead inductance. This typically occurs at 500 megahertz for 100 picofarads, decreasing to 50 megahertz at .01 microfarads and 10 MHz at 0.1  $\mu\text{F}$ .
- Class III and IV, typical applications are power and logic bus coupling and decoupling, and broad band bypass filtering. Class I and II are chosen for frequency discriminating filters, d-c blocking, reference circuits, and similar circuits requiring close tolerance and stability.

**TEMPERATURE:**

- Capacitors are designed for service temperatures of  $-55^\circ\text{C}$  to  $+105^\circ\text{C}$ . The limiting factor is the life of the polymer coating. Ceramic discs are not injured by short time exposure up to  $125^\circ\text{C}$ .
- In applications where there is continuous heat dissipation in the capacitor, such as in snubber networks for power semiconductors, the case temperature rise should be limited to  $30^\circ\text{C}$ . Class I, II and III are well suited for snubber service. See chart below for wattage ratings.

**VOLTAGE:**

- The extensive range of d-c voltage ratings available allows selection of the appropriate device to minimize d-c voltage effects in the circuit.
- A-c voltage ratings for capacitors up to 1000 volts applies to applications where energy and current are limited by circuit impedance. 1000 ohms impedance at the maximum a-c voltage rating is adequate.
- Ratings apply up to 50 khz. Above 50 khz reduce a-c voltage rating by:  $\left(\frac{\text{frequency}}{50 \text{ khz}}\right)^2$

**CURRENT:**

- For sinusoidal applied voltages:  $I_{\text{rms}} = 7 \sqrt{VFC}$  where V = rms Voltage; F = frequency; C = farads  
 Power dissipation may be approximated by: Watts =  $(I_{\text{rms}})^2 \times \text{Effective series resistance (ESR)}$

Approximate ESR Values: Class I,  $\text{ESR} = \frac{100}{C(\text{pF})f(\text{MHz})}$  Ex.: 10 pF ESR = 10 Ohms at 1 megahertz  
 Class II or III,  $\text{ESR} = \frac{1}{C(\mu\text{F})f(\text{kHz})}$  Ex.: .001  $\mu\text{F}$  ESR = 100 Ohms at 10kHz

Example:

$100 \text{ V } .001 \mu\text{F}$  IRMS =  $7 \times 100 \times (50 \times 10^3) \times (.001 \times 10^{-6}) = 35 \text{ ma}$   
 50 khz Power Dissipation =  $(35 \times 10^{-3})^2 \times 20 = .024 \text{ watts}$

- For nonsinusoidal applied voltage (repetitive transient pulses) limit on peak current is:

$I_p = \frac{dv}{dt} \times C$  where V = volts; T = seconds; C = farads

- Approximate  $\frac{dv}{dt}$  limits:
- $\leq 100\text{pF} = 10,000\text{V}/\text{microsecond}$ , Class I
  - $> 100\text{pF} = 5,000\text{V}/\text{microsecond}$ , Class I
  - $< 100\text{pF} = 5,000\text{V}/\text{microsecond}$ , Class II
  - $100\text{pF} - 1000\text{pF} = 2,000\text{V}/\text{microsecond}$ , Class II & III
  - $1000\text{pF} - 10,000\text{pF} = 1,000\text{V}/\text{microsecond}$ , Class II & III
  - $> 10,000\text{pF} = 500\text{V}/\text{microsecond}$ , Class II & III
  - $> 10,000\text{pF} = 100\text{V}/\text{microsecond}$ , Class IV

Example: .001  $\mu\text{F}$ , Class II;  $I_p = \frac{1000}{10^{-6}} \times (.001 \times 10^{-6}) = 1 \text{ ampere peak}$

Note: Above calculations are typical. Actual circuit conditions may allow more or less current and voltage. Actual circuit test is recommended.

## CERAMIC DISC CAPACITORS AS SNUBBERS

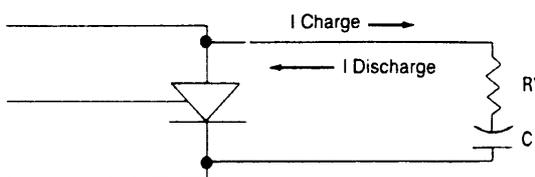

\*Select R to limit dv/dt and di/dt to capacitor and semiconductor ratings.

See page 5 & 10 for parts selection from 10TS, new "lossless" 10TCU type, and new "lossless" 2KV DFO types.

ALLOWABLE POWER DISSIPATION (Watts) 30°C RISE

Cap. Size Code	Capacitor Voltage Rating			
	500 V	1000 V	3000 V	6000 V
C-E	.25 W	.50 W	1 W	—
F-H	.50 W	.75 W	1.5 W	1.7 W
J-K	1 W	1.5 W	3 W	3.3 W
L-Q	2 W	3 W	5 W	5.5 W

**LOW VOLTAGE 12V to 1KV CAPACITORS**

Capacitors on pages 4 and 5 are stocked at the factory and are in distribution. See pages 6 and 7 for other electrical and mechanical options.

**Figure 1**

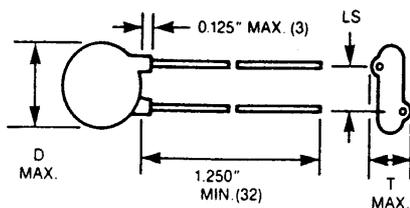

**STANDARD WIRE SIZE**  
 C and E Sizes  
 24 Gauge (.020")  
 Tin Coated Copperweld  
  
 F thru Q Sizes  
 22 Gauge (.025")  
 Tin Coated Copper

**Figure 1a** Dimensions are inch (cm.)

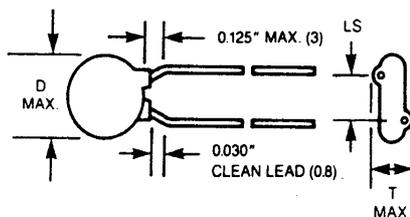

**Figure 2**

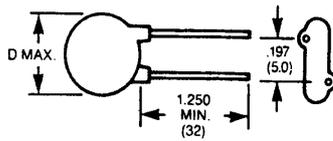

Size Code	Maximum Diameter		Maximum Thickness		Fig. 1 & 1a Lead Spacing	
	IN	MM	IN	MM	IN	MM
C	.250"	6.3	.156"	4.0	.250	6.3
E	.290"	7.4	.156"	4.0	.250	6.3
F	.370"	9.4	.156"	4.0	.250	6.3
G	.440"	11.2	.156"	4.0	.250	6.3
H	.490"	12.4	.156"	4.0	.250	6.3
H <sup>3</sup>	.490"	12.4	.156"	4.0	.375	9.4
J	.560"	14.2	.156"	4.0	.375	9.4
K	.630"	16.0	.156"	4.0	.375	9.4
L	.680"	17.0	.156"	4.0	.375	9.4

Size Code	Maximum Diameter		Maximum Thickness		Fig. 1 & 1a Lead Spacing	
	IN	MM	IN	MM	IN	MM
M	.760"	19.3	.156"	4.0	.375	9.4
P	.890"	22.4	.156"	4.0	.375	9.4
R	.510"	13.0	.200"	5.1	.250	6.3
U	.640"	16.3	.200"	5.1	.375	9.4
W	.700"	17.8	.200"	5.1	.375	9.4
X	.770"	19.6	.200"	5.1	.375	9.4
Y	.900"	22.5	.200"	5.1	.375	9.4
Q	.950"	24.1	.200"	5.1	.375	9.4

**Figure 3**

**TAPE AND REEL STANDARDS**

Cataloged product 12 thru 1000 volts with size code C to H are available tape and reeled to EIA RS468 on a special order basis. 10,000 piece minimum, three lead styles are available.

To order tape and reel, add to catalog number the lead style type:

Example: TGS10 QA (Style)

LS is 5 mm (.197) for tape and reel.

TYPE QA/QR TYPE RE/RR TYPE TK/TR  
 Figure 1a only

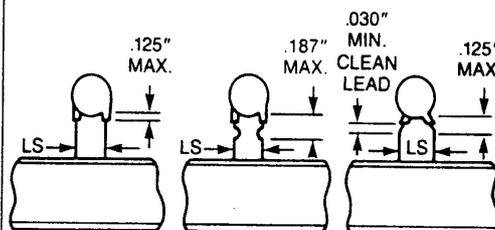

Use if leads are to be formed. Will furnish if nothing else specified.

Most stable seating plane for auto insertion. Keeps rundown out of holes.

Controls coating run-down with low seated height.

QA RE TK

QR RR TR

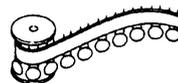

Cera-Mite Standard



EIA RS-468A Std

**100 VOLT GENERAL PURPOSE**

**562C SERIES**

• Application range:  
 Up to 250 VDC, 75 VAC RMS\*\*

• Insulation Resistance: 10,000 MΩ minimum; 500 ΩF  
 • Dissipation Factor: 3.0% max

• Dielectric Strength:  
 750 VDC, 250 VAC RMS

pF	Tol. Code	Catalog Number	Size		Temp. Coef.
			Figure	Code	
10	J	TSQ10	2	C	NPO
22	J	TCQ22	2	C	NPO
33	K	TCQ33	2	C	U2J
47	K	TSQ47	2	C	U2J
100	K	TST10	2	C	X7R
220	K	TST22	2	C	X7R
330	K	TST33	2	C	X7R

μF	Tol. Code	Catalog Number	Size		Temp. Coef.
			Figure	Code	
470pF	K	TST47	2	C	X7R
.001	K	TSD10	2	C	X7R
.0022	K	TSD22	2	E	X7R
.0033	K	TSD33	2	F	X7R
.0047	K	TSD47	2	G	X7S
.0068	K	TSD68	2	G	X7S
.01	K	TSS10	2	H	X7S

μF	Tol. Code	Catalog Number	Size		Temp. Coef.
			Figure	Code	
.005	M	TSD50	1	E	Z5U
.01	M	TGS10	1	F	Z5U
.02	M	TGS20	1	G	Z5U
.022	M	TSS22	1	R	X7S
.047	M	TSS47	1	W	X7S
.050	M	TGS50	1	R	Z5U
.10	M	TGP10	1	W	Z5U

**500 VOLT GENERAL PURPOSE**

**562C SERIES**

• Application range:  
 Up to 600 VDC, 100 VAC RMS\*\*

• Insulation Resistance: 15,000 MΩ minimum; 750 ΩF  
 • Dissipation Factor: 3.0% max

• Dielectric Strength:  
 1500 VDC, 300 VAC RMS

μF	Tol. Code	Catalog Number	Size		Temp. Coef.
			Figure	Code	
.001	K	5TSD10	1a	E	X7R
.001	M	5TSSD10	1a	C	Y5U
.0022	K	5TSD22	1a	F	X7R
.0033	K	5TSD33	1	G	X7R
.0047	K	5TSD47	1	H	X7R
.005	Z	5TSD50	1	F	Z5U
.0068	K	5TSD68	1	H	X7R

μF	Tol. Code	Catalog Number	Size		Temp. Coef.
			Figure	Code	
.01	K	5TSS10	1	J	X7R
.01	M	5GASS10	1	G	Z5U
.01	Z	5HKSS10	1	G	Z5U
.02	M	5GASS20	1	J	Z5U
.022	M	5TSS22	1	K	X7S
.033	M	5TSS33	1	X	X7S
.05	M	5GASS50	1	P	Z5U

μF	Tol. Code	Catalog Number	Size		Temp. Coef.
			Figure	Code	
.05	Z	5HKSS50	1	U	Z5U
.10	M	5GAP10	1	X	Z5U
.10	Y	5HKSP10	1	Q	Y5V
.10	Z	5HKP10	1	X	Z5U
.15	Y	5GAP15	1	Y	Z5U
.20	M	5GAP20	1	Q	Z5U

\*\*See page 3 for application limits on AC voltage

1000 VOLT GENERAL PURPOSE

562C SERIES

- Application range:  
Up to 1000 VDC, 150 VAC RMS\*\*

- Insulation Resistance: 20,000 MΩ minimum; 1000 ΩF
- Dissipation Factor: 2.5%

- Dielectric Strength:  
2500 VDC, 500 VAC RMS

pF	Tol. Code	Catalog Number	Size		Temp. Coef.	μF	Tol. Code	Catalog Number	Size		Temp. Coef.	μF	Tol. Code	Catalog Number	Size		Temp. Coef.
			Figure	Code					Figure	Code					Figure	Code	
10	M	5GAQ10	1a	C	NPO	.001	M	5GAD10	1a	E	X5S	.0050	M	5GAD50	1	F	Z5U
20	M	5GAQ20	1a	C	NPO	.001	P	5HKD10	1a	E	Y5U	.0068	M	5GAD68	1	G	Z5U
33	M	5GAQ33	1a	E	U2J	.0012	M	5GAD12	1a	E	Z5U	.0082	M	5GAD82	1	H	Z5U
47	M	5GAQ47	1a	E	U2J	.0015	M	5GAD15	1a	E	Z5U	.01	M	5GAS10	1	H <sup>3</sup>	Z5U
100	M	5GAT10	1a	C	X5F	.0020	M	5GAD20	1	E	Z5U	.01	M	5HKMS10	1	H	Z5U
150	M	5GAT15	1a	C	X5F	.0022	M	5GAD22	1	E	Z5U	.01	P	5HKS10	1	H <sup>3</sup>	Z5U
200	M	5GAT20	1a	C	X5F	.0025	M	5GAD25	1	E	Z5U	.015	M	5GAS15	1	J	Z5U
220	M	5GAT22	1a	C	X5F	.0027	M	5GAD27	1	E	Z5U	.020	M	5GAS20	1	L	Z5U
330	M	5GAT33	1a	C	X5F	.0030	M	5GAD30	1	E	Z5U	.050	M	10HKS50	1	X	Z5U
470	M	5GAT47	1a	C	X5F	.0033	M	5GAD33	1	E	Z5U	.10	M	10GAP10	1	Q	Z5U
500	M	5GAT50	1a	C	X5F	.0047	M	5GAD47	1	F	Z5U	.15	M	10GAP15	1	Q	Y5V

1 KV TEMP. AND VOLTAGE STABILIZED, 10% TOL.

562C SERIES

- Application range:  
Up to 1250 VDC, 200 VAC RMS\*\*

- Insulation Resistance: 50,000 MΩ minimum; 1000 ΩF
- Dissipation Factor: 2.0%

- Dielectric Strength:  
2500 VDC, 750 VAC RMS

pF	Catalog Number	Size		Temp. Coef.	pF	Catalog Number	Size		Temp. Coef.	pF	Catalog Number	Size		Temp. Coef.	pF	Catalog Number	Size		Temp. Coef.
		Figure	Code				Figure	Code				Figure	Code				Figure	Code	
10	10TSQ10	1a	C	NPO	75	10TSQ75	1a	C	X5F	270	10TST27	1a	C	X5F	820	10TST82	1a	E	X5F
25	10TSQ25	1a	E	NPO	82	10TSQ82	1a	C	X5F	300	10TST30	1a	C	X5F	.001μF	10TSD10	1a	E	X5F
27	10TSQ27	1a	C	U2J	100	10TST10	1a	C	X5F	330	10TST33	1a	C	X5F	.0015	10TSD15	1	G	X5F
30	10TSQ30	1a	C	U2J	120	10TST12	1a	C	X5F	390	10TST39	1a	C	X5F	.0020	10TSD20	1	H <sup>3</sup>	X5F
33	10TSQ33	1a	E	U2J	150	10TST15	1a	C	X5F	470	10TST47	1a	C	X5F	.0022	10TSD22	1	H <sup>3</sup>	X5F
39	10TSQ39	1a	E	U2J	180	10TST18	1a	C	X5F	500	10TST50	1a	C	X5F	.0027	10TSD27	1	J	X5F
47	10TSQ47	1a	E	U2J	200	10TST20	1a	C	X5F	560	10TST56	1a	E	X5F	.0033	10TSD33	1	J	X5F
50	10TSQ50	1a	E	U2J	220	10TST22	1a	C	X5F	680	10TST68	1a	E	X5F	.0047	10TSD47	1	L	X5F
56	10TSQ56	1a	C	X5F	250	10TST25	1a	C	X5F	750	10TST75	1a	E	X5F	.01	10TSS10	1	K	X5S
68	10TSQ68	1a	C	X5F															

1 KV NPO/N750 PRECISION DISC CAPACITORS, 5% TOL.

561C SERIES  
Temperature/Frequency/Voltage Stable

- Application range:  
Up to 1500 VDC, 300 VAC RMS\*\*
- dv/dt up to 10,000 V/usec

- Insulation Resistance: 100,000 MΩ minimum; 1000 ΩF
- Dielectric Strength: 2500 VDC, 750 VAC RMS
- High Q: 1000; Dissipation Factor 0.1%

- Application: NPO capacitors are used when the ultimate in stability is required.
- N750/S3L are smaller and ideal for "lossless snubbers."

pF	Catalog Number	Size		pF	Catalog Number	Size		pF	Catalog Number	Size		pF	Catalog Number	Size		Temp. Coef.
		Figure	Code			Figure	Code			Figure	Code			Figure	Code	
1.0	10TCCV10	1a	C	10	10TCCQ10	1a	C	47	10TCCQ47	1	G	N750/S3L DISC CAPACITORS				
2.2	10TCCV22	1a	C	12	10TCCQ12	1a	C	50	10TCCQ50	1	G	33	10TCUQ33	1a	C	U
2.7	10TCCV27	1a	C	15	10TCCQ15	1a	C	56	10TCCQ56	1	G	47	10TCUQ47	1a	C	U
3.0	10TCCV30	1a	C	18	10TCCQ18	1a	E	68	10TCCQ68	1	H	68	10TCUQ68	1a	F	U
3.3	10TCCV33	1a	C	20	10TCCQ20	1a	E	82	10TCCQ82	1	H <sup>3</sup>	100	10TCUT10	1a	F	U
3.9	10TCCV39	1a	C	22	10TCCQ22	1a	E	100	10TCCQ100	1	J	220	10TCUT22	1	G	V
4.7	10TCCV47	1a	C	25	10TCCQ25	1a	E	120	10TCCQ120	1	J	330	10TCUT33	1	H	V
5.0	10TCCV50	1a	C	27	10TCCQ27	1a	F	150	10TCCQ150	1	K	470	10TCUT47	1	J	V
5.6	10TCCV56	1a	C	30	10TCCQ30	1a	F	180	10TCCQ180	1	L	560	10TCUT56	1	J	V
6.8	10TCCV68	1a	C	33	10TCCQ33	1a	F	220	10TCCQ220	1	M	680	10TCUT68	1	K	W
8.2	10TCCV82	1a	C	39	10TCCQ39	1a	F	270	10TCCQ270	1	P	1000	10TCUD10	1	L	W

- Application:  
Low Voltage Bulk Filter

12/25/50/100V HYPERCON HIGH-CAPACITANCE DISCS

563C SERIES CLASS IV DIELECTRIC

12VDC, Y5R, 2.5ΩF, 5% DF					25VDC, Y5R, 5ΩF, 5% DF					50VDC, Y5R, 25ΩF, 4% DF					100VDC, Y5S, 100ΩF, 3% DF				
μF	Tol. Code	Catalog Number	Size		μF	Tol. Code	Catalog Number	Size		μF	Tol. Code	Catalog Number	Size		μF	Tol. Code	Catalog Number	Size	
			Figure	Code				Figure	Code				Figure	Code				Figure	Code
.05	Y	HY105	1a	E	.01	M	HY820	1a	C	.01	M	HY920	1a	C	.0022	M	HMMD22	2	C
.10	M	HY110	1	G	.022	M	HY825	1a	E	.022	M	HY925	1a	F	.0047	M	HMMD47	2	C
.22	M	HY122	1	J	.033	M	HY530	1a	E	.047	M	HY935	1	G	.01	M	HMMS10	1a	E
.47	M	HY147	1	P	.047	M	HY835	1	F	.10	M	HY950	1	H	.1	M	HMMP10	1	L
					.10	M	HY850	1	G										

\*\*See page 3 for application limits on AC voltage

# ELECTRICAL AND MECHANICAL OPTIONS

The most popular values and constructions are shown on pages 4 and 5 for 12 volt to 1KV ratings and on page 10 for 2 to 6KV ratings. Other values and other lead styles are available. The tables following show the complete range of product. Other lead styles are shown on page 7 and an 18 character alpha-numeric designator is shown. The Cera-Mite application engineer

will provide a certified outline drawing and a correct part number for the options specified. Customer approval of the outline is usually requested to guarantee satisfaction.

All of the performance characteristics shown in the catalog apply to the options unless otherwise stated on the outlines.

**562 and 564 Class II & III Series Electrical Options (General Purpose)**

Ceramic Type	Range of Values (picofarads)					Tolerances		
	500V	1000V	2000V	3000V	6000V	500	1000V	2 to 6KV
	Size C thru Q	Size C thru Q	Size E thru Q	Size E thru Q	Size F thru P			
X5F	200 - 22,000	100 - 20,000	68 - 12,000	47 - 10,000	47 - 2,200	K,M	K,M	K,M
X5S	400 - 25,000	300 - 25,000	470 - 15,000	390 - 10,000	220 - 2,700	M	K,M	K,M
X7R	500 - 33,000	390 - 33,000	680 - 22,000	470 - 15,000	560 - 4,700	K,M	K,M	K,M
Y5U	1000 - 50,000	750 - 50,000	560 - 33,000	390 - 22,000	470 - 5,600	M	M	M,Y
Z5U	1,500 - 100,000	1,000 - 100,000	1,000 - 47,000	680 - 33,000	820 - 10,000	M,Z	M,Z	M,Z
Y5V	2,000 - 200,000	1,500 - 150,000	15,000 - 100,000	1,000 - 50,000	N/A	Y,Z	M,Z	M,Z

Note: 100V ratings are available in same ranges as 500V.

**561 and 564 Class I Series Electrical Options (Precision and over 50 kHz)**

Ceramic Type	Range of Values (picofarads)				Tolerances
	500V	1000V	2000V	3000V	
	Size C thru L	Size C thru M	Size E thru P	Size E thru P	
NPO	10 - 390	1 - 330	1 - 270	1 - 180	C,D,J,K
N750	47 - 680	22 - 470	10 - 330	10 - 270	J,K
N1000	56 - 820	33 - 560	15 - 390	10 - 330	J,K
N2200	68 - 750	56 - 680	33 - 560	22 - 470	J,K
N3300	100 - 1,000	75 - 820	47 - 750	33 - 560	J,K
N4700	N/A	330 - 5,600	220 - 4,700	100 - 3,300	K,M

Note: Cera-Mite also offers capacitors in N030, N080, N150, N220, N330 and N470 characteristics to serve those older radio and tuning applications requiring TC matching. Values are available in the same range as NPO.

## DESCRIPTIVE DESIGNATOR USED FOR PARTS NOT LISTED IN CATALOG BUT SELECTED FROM RANGE CHARTS

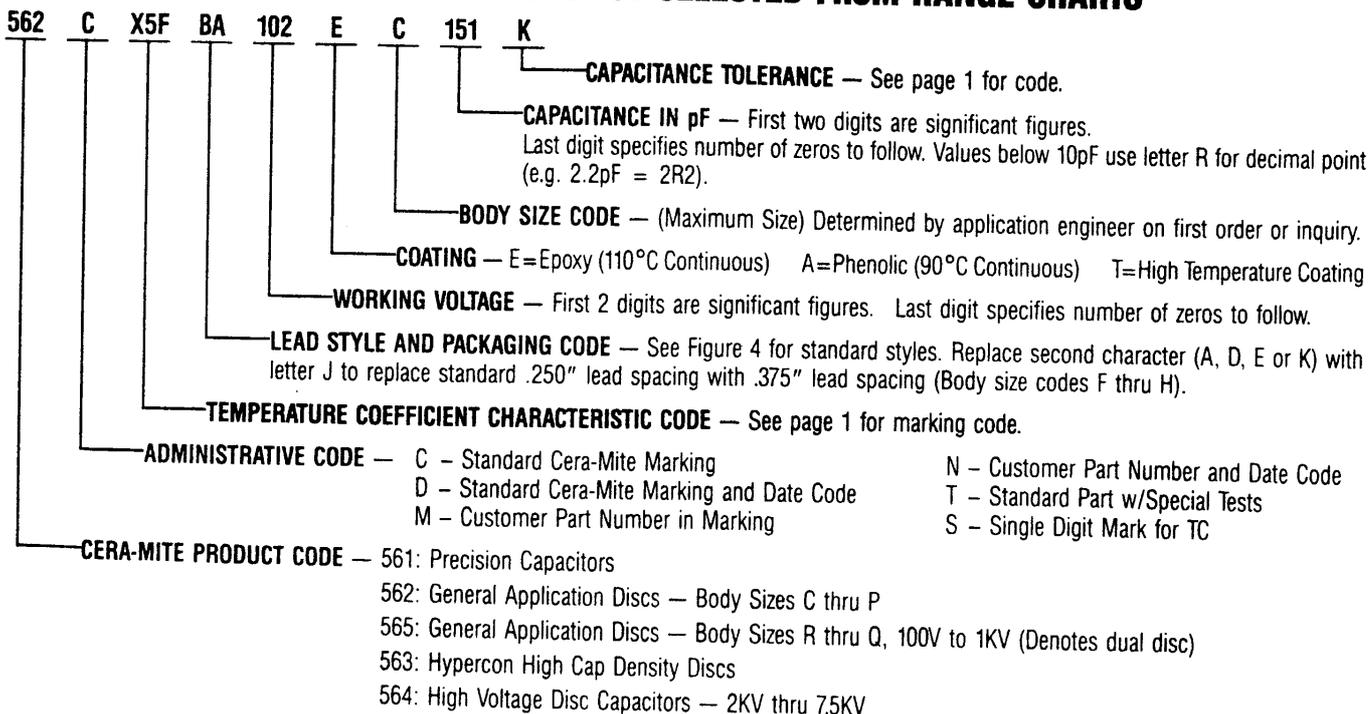

**STANDARD LEAD OPTIONS**

Figure 4a1

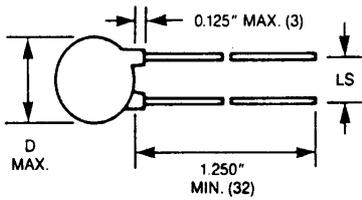

- 2KV to 7.5KV AA: #20 Ga; .250", .375" and .500" LS; Bulk Pack
- 12V to 1KV BA: #22 Ga; .250" and .375" LS; Bulk Pack
- 12V to 1KV MA: #22 Ga; 5mm LS Bulk Pack
- 12V to 3KV QA: #22 Ga; 5mm LS Tape and Reel
- 12V to 1KV UA: #24 Ga; .250" and .375" LS; Bulk Pack

Figure 4a2

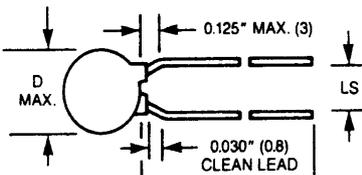
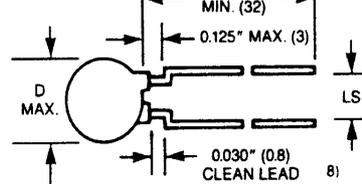

Figure 4a3



- 12V to 1KV CK: #22 Ga; .250" LS; Bulk Pack; "C" and "E" Sizes Only
- 12V to 1KV DK: #22 Ga; 5mm LS; Bulk Pack; "C" and "E" Sizes Only
- 12V to 1KV TK: #22 Ga; 5mm LS; Tape and Reel; "C" and "E" Sizes Only
- 12V to 1KV WK: #24 Ga; .250" LS; Bulk Pack; "C" and "E" Sizes Only

Figure 4a2 and 4a3 are functionally the same and are interchangeable.

**CUT LEAD OPTIONS**

Figure 4b1

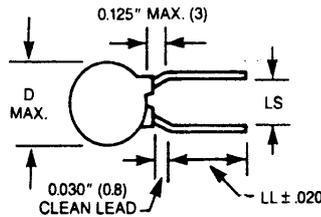

- 12V to 1KV NK: #22 Ga; .250" and 5mm LS; Bulk Pack; Minimum LL of .140"; "C" and "E" Sizes Only
- 12V to 1KV PK: #24 Ga; .250" and 5mm LS; Bulk Pack; Minimum LL of .140"; "C" and "E" Sizes Only

Figure 4b2

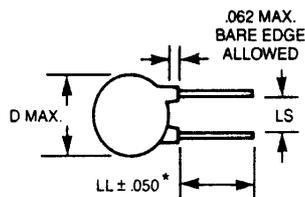

- 12V to 1KV FD: #22 Ga; .250", .375" and 5mm LS; Bulk Pack; Minimum LL of .110"; Phenolic Coating Only
- 12V to 1KV PD: #24 Ga; .250" and 5mm LS; Bulk Pack; Minimum LL of .110"; Phenolic Coating Only

Figure 4b3

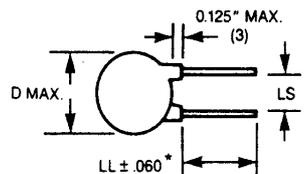

- 12V to 3KV FA: #22 Ga; .250", .375" and 5mm LS; Bulk Pack; Minimum LL of .110"; Epoxy Coating Only
- 12V to 3KV PA: #24 Ga; .250" and 5mm LS; Bulk Pack; Minimum LL of .110"; Epoxy Coating Only

\*The minimum LL is shown. The EIA standard LL is .187". User to specify length required. If not specified, .187" is furnished.

**CRIMPED LEAD OPTIONS**

Figure 4c1

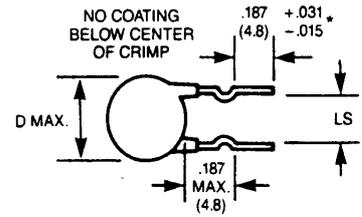

- 12V to 3KV JE: #22 Ga; .250" and .375" Lead Spacing; Bulk Pack
- 12V to 3KV SE: #22 Ga; 5mm Lead Spacing; Bulk Pack
- 12V to 3KV RE: #22 Ga; 5mm Lead Spacing; Tape and Reel

\*Other LL are available (.120" min.)

Figure 4c2

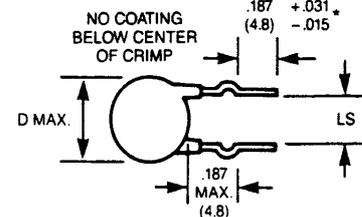

- 12V to 3KV KE: #22 Ga; .250" and .375" Lead Spacing; Bulk Pack

\*Other LL are available (.120" min.)

Consult factory for lead styles not shown on this page.

Note: Other lead styles specified on customer drawings can be furnished on reasonable demand.

**SPECIALTY ITEMS**

**ARC-CAP**

Working Voltage: 100 to 1500VDC  
 High Energy Air GAP Discharge at 2-3KVDC  
 Capacitance: .01µF Z Tolerance Std. 564C10ARCS10  
 1000pF Z Tolerance Std. 564C10ARCD10

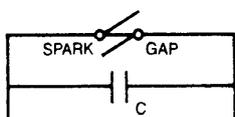

Equivalent to Centralab GAP series and Mallory AT series.

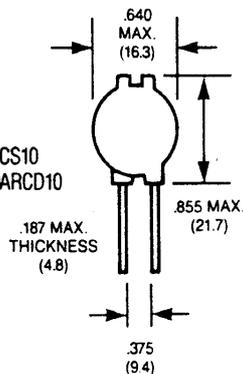

**DISCOIDAL FEED-THRU CAPACITORS (Old Style — Pre 1975 Systems)**

Capacitance Range: 33pF to .02µF  
 Application Range: Up to 500 VDC  
 Operating Temperature Range: -55°C to +85°C (X5F); +10°C to +85°C (Z5U)  
 Dielectric Strength: 250% rated voltage  
 Dissipation Factor: 2.0% (X5F); 3.0% (Z5U)  
 Capacitance Tolerance: ±10%=K; ±20%=M; +100-0%=P; +80-20%=Z

Insulation Resistance: 200 megohm-microfarads minimum.

**Type 514C**

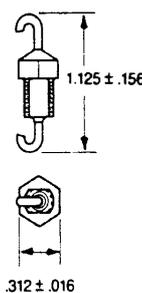

**Type 507C**

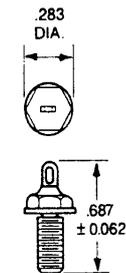

**Type 533C**

