

AEV 24V&48V Input Series

Technical Reference Notes

Single and Dual Output Series

25W DC-DC Converter

(Rev01)



AEV 24V&48V Input Series DC-DC Converters Single And Dual Output, 25 Watt DC-DC Converters

AEV Technical Description

The AEV series of switching DC-DC converters is one of the most cost effective options available in component power. The AEV uses an industry standard package size and pinout configuration, and provides control and trim functions.

AEV converters come in 24V or 48V input versions, each of which uses a 2:1 input range. Outputs are isolated from the input and the converters are capable of providing up to 25 watts of output power.

At startup, input current passes through an input filter designed to help meet CISPR 22 level A radiated emissions, and Bellcore GR1089 conducted emissions. A fuse should be used in line with the input.

The AEV converters are pulse width modulated (PWM) and operate at a nominal fixed frequency of 330 kHz. Feedback to the PWM controller

uses an opto-isolator, maintaining complete isolation between primary and secondary. Caution should be taken to avoid ground loops when connecting the converter to ground. Output power is typically available within 10 ms after application of input power.

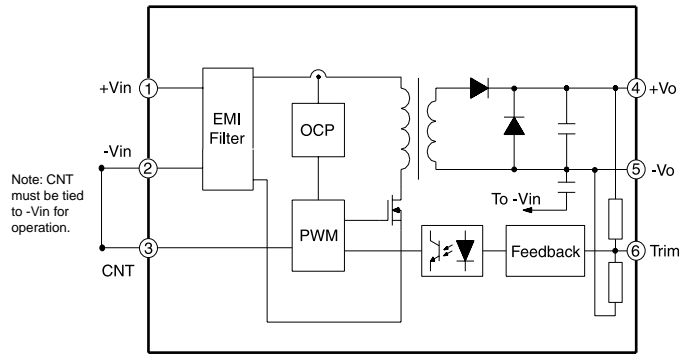

Fig. 1. AEV Single Output Block Diagram

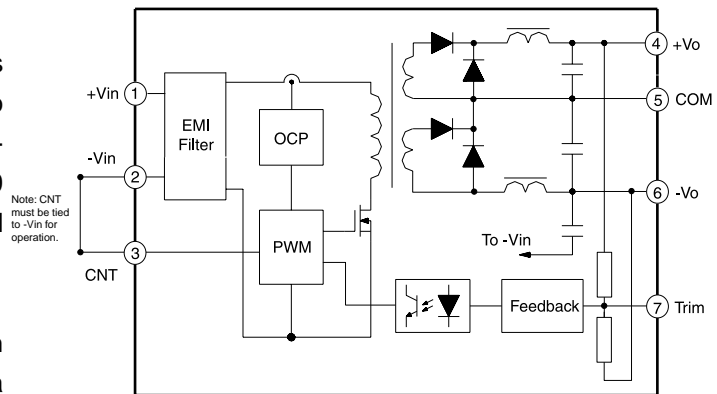

Fig. 2. AEV Dual Output Block Diagram

AEV Series Electrical Input

Input

The +Vin and -Vin pins are located as shown in the mechanical drawings at the end of this manual. AEV converters have a 2:1 input voltage range; 24 Vin converters can accept 18-36 Vdc, and 48 Vin converters can accept 36-72 Vdc. Care should be taken to avoid applying reverse polarity to the converters which can damage the converter.

Input Reverse Voltage Protection

Under installation and cabling conditions where reverse polarity across the input may occur, reverse polarity protection is recommended. Protection can easily be provided as shown in Figure 3. In both cases the diode used is rated for 4A/100V. Placing the diode across the inputs rather than in-line with the input offers an advantage in that the diode only conducts in a reverse polarity condition, which increases circuit efficiency and thermal performance.

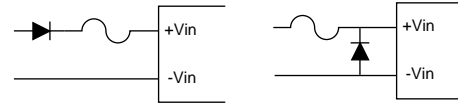

Fig. 3. Reverse Polarity Protection Circuits

Input Undervoltage Protection

The AEV is protected against undervoltage on the input. If the input voltage should drop below the acceptable range, the converter will shut down. It will automatically restart when the undervoltage condition is removed.

Input Overvoltage Protection

The AEV is protected against overvoltage on the input. If the input voltage should rise above the acceptable range, the converter will shut down. It will automatically restart when the undervoltage condition is removed.

Input Filter

Input filters are included in the converters to help achieve standard system emissions certifications. Some users however, may find that additional input filtering is necessary. The AEV series has an internal switching frequency of 330 kHz so a high frequency capacitor mounted close to the input terminals produces the best results. To reduce reflected noise, a capacitor can be added across the input as shown in Figure 4, forming a π filter. A 47 μ F/100V electrolytic capacitor is recommended for C1.

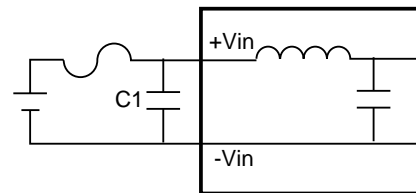

Fig. 4. Ripple Rejection Input Filter

For conditions where EMI is a concern, a different input filter can be used. Figure 5 shows an input filter designed to reduce EMI effects. L1 is a 1mH common mode inductor, C₁ is a 47 μ F/100V electrolytic capacitor, and C₂ is a 1 μ F/100V metal film or ceramic high frequency capacitor, and C_{y1} and C_{y2} are each 4700 pF high frequency ceramic capacitors.

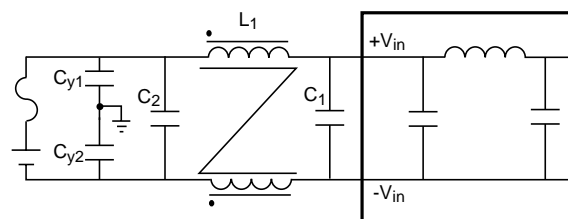

Fig. 5. EMI Reduction Input Filter

AEV 24V&48V Input Series DC-DC Converters Single And Dual Output, 25W DC-DC Converters

When a filter inductor is connected in series with the power converter input, an input capacitor C_1 should be added. An input capacitor C_1 should also be used when the input wiring is long, since the wiring can act as an inductor. Failure to use an input capacitor under these conditions can produce large input voltage spikes and an unstable output.

Input Fusing

Standard safety agency regulations require input fusing. Recommended fuse ratings for the AEV Series are shown in Table 1.

	Nominal	
Input	Input	Fuse
24V	24V	5A
48V	48V	2.5A

Table 1. Fuse Ratings

AEV Series Electrical Output

Output Connections (+Vout, -Vout)

Outputs on the AEV series are isolated from the input and can therefore be left to float or can be grounded. Pin connections for +Vout, and -Vout are shown in the mechanical drawings at the end of this manual.

Sharing Power Between Dual Outputs

Each output of a dual output AEV is limited to one half of the total power capacity of the converter. For example, if the positive output of an AEV01CC48 only draws 5W, the negative output will still be limited to 12.5W. Voltage regulation performance is best when the outputs are balanced. Figure 6 shows typical cross regulation for a 15 volt output.

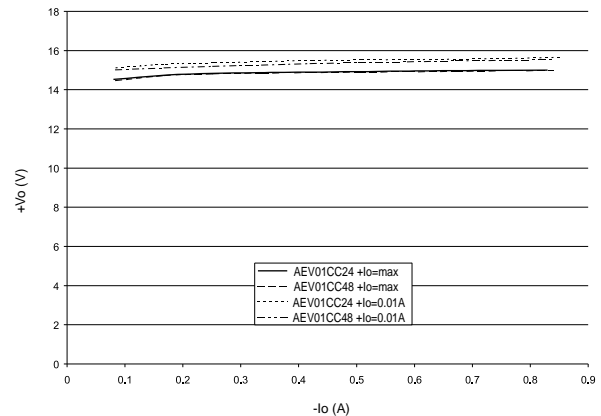

Fig. 6. Cross Regulation

Overcurrent Protection (OCP)

AEV series DC/DC converters feature fold-back current limiting as part of their Overcurrent Protection (OCP) circuits. When output current exceeds 115 to 150% of rated current, such as during a short circuit condition, the output will shutdown immediately, and can tolerate short circuit conditions indefinitely. When the overcurrent condition is removed, the converter will automatically restart.

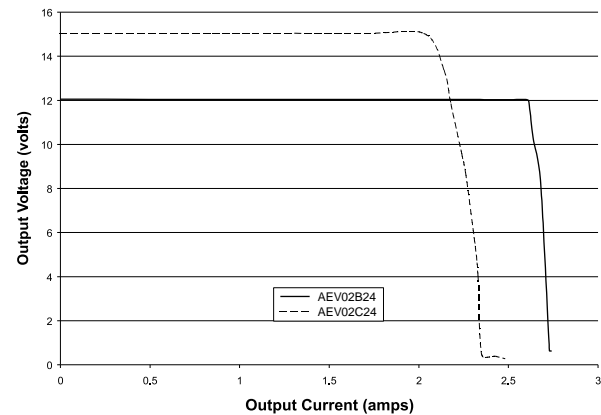

Fig. 7. Overcurrent Performance

AEV 24V&48V Input Series DC-DC Converters Single And Dual Output, 25W DC-DC Converters

Overvoltage Protection (OVP)

The AEV series provides overvoltage protection on the output, which will shut the output off if the voltage exceeds 120 to 140% of the nominal output voltage. If the OVP circuit activates, power to the converter should be cycled to turn the converter back on.

Trim

The output voltage of the AEV series can be trimmed using the trim pin provided. Applying a voltage to the trim pin through a voltage divider from the output will cause the output to increase or decrease by up to 10%. Trimming up by more than 10% of the nominal output may activate the OVP circuit or damage the converter. Trimming down more than 10% can cause improper regulation. When trimming a dual output converter, both outputs trim simultaneously.

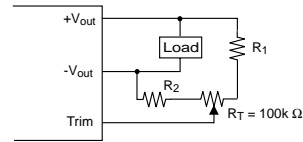

	Single Output Converters				Dual Output Converters				
	±10%		±5%		±10%		±5%		
	R1	R2	R1	R2	R1	R2	R1	R2	
3.3V out					±5V out	33	12	63	22
5V out					±12V out	120	11	200	20
12V out	47	12	86	22	±15V out	150	10	270	20
15V out	68	12	120	22					

All resistor values in kΩ

Fig. 8. Variable Trim

Fixed and variable trim circuits are shown in Figures 7 to 9. Note that resistor values will change depending on the converter used. For trim ranges not listed, contact the factory for assistance.

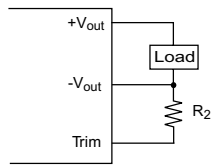

Single Output Converters	Dual Output Converters
3.3Vout: $R_1 = \frac{0.77}{y} - 1$	±5V out: $R_1 = \frac{1.87}{y} - 2.2$
5Vout: $R_1 = \frac{1.87}{y} - 1$	±12V out: $R_1 = \frac{2.23}{y} - 2.2$
6Vout, 12Vout: $R_1 = \frac{1.97}{y} - 1$	±15V out: $R_1 = \frac{2.28}{y} - 2.2$
15Vout: $R_1 = \frac{2.08}{y} - 1$	where $y = \frac{V_o - V_e}{V_e}$
where $y = \frac{V_o - V_e}{V_e}$	All resistor values in kΩ

Fig. 9. Fixed Trim Up

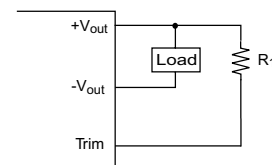

Single Output Converters	Dual Output Converters
3.3V out: $R_1 = \frac{1.27}{y} - 3.03$	±5V out: $R_1 = \frac{5.6}{y} - 9.67$
5V out: $R_1 = \frac{5.6}{y} - 8.47$	±12V out: $R_1 = \frac{19.18}{y} - 23.61$
6Vout, 12Vout: $R_1 = \frac{7.49}{y} - 10.46$	±15V out: $R_1 = \frac{25.11}{y} - 29.59$
15V out: $R_1 = \frac{10.38}{y} - 13.45$	where $y = \frac{V_e - V_o}{V_e}$
where $y = \frac{V_e - V_o}{V_e}$	All resistor values in kΩ

Fig. 10. Fixed Trim Down

CNT Function

The AEV provides a control function allowing the user to turn the output on and off using an external circuit. Applying a voltage greater than 7V to the CNT pin will disable the output, while applying a voltage less than 3.0V will enable it. The performance of the converter between these two points will depend on the individual converter and whether the control voltage is increasing or

AEV 24V&48V Input Series DC-DC Converters Single And Dual Output, 25W DC-DC Converters

decreasing. The CNT pin must be connected to $-V_{in}$ for operation. If the CNT pin is left open, the converter will default to “control off” and the output will not turn on. The maximum voltage that can be applied to the CNT pin is 80 volts.

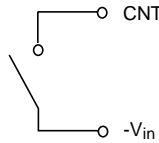

Fig. 11. Simple Control Circuit

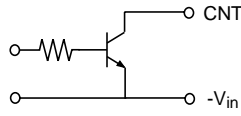

Fig. 12. Transistor Control Circuit

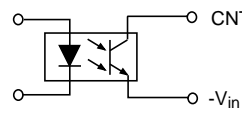

Fig. 13. Isolated Control Circuit

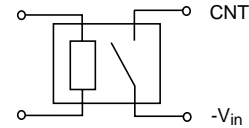

Fig. 14. Relay Control Circuit

Output Filters

When the load is sensitive to ripple and noise, an output filter can be added to minimize the effects. A simple output filter to reduce output ripple and noise can be made by connecting a capacitor across the output as shown in Figure 15. The recommended value for the output capacitor is $470\mu\text{F} / 10\text{V}$ for single outputs up to 5 volts, $100\mu\text{F} / 25\text{V}$ for 12 and 15 volt single outputs, and $220\mu\text{F} / 25\text{V}$ on each output for dual output converters.

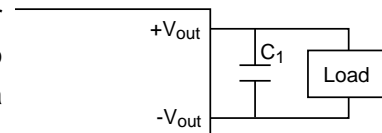

Fig. 15. Output Ripple Filter

Extra care should be taken when long leads or traces are used to provide power to the load. Long lead lengths increase the chance for noise to appear on the lines. Under these conditions C_2 can be added across the load as shown in Figure 16. The recommended component for C_2 is $1\mu\text{F}$ ceramic capacitor.

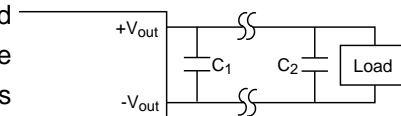

Fig. 16. Output Ripple Filter for a Distant Load

Decoupling

Noise on the power distribution system is not always created by the converter. High speed analog or digital loads with dynamic power demands can cause noise to cross the power inductor back onto the input lines. Noise can be reduced by decoupling the load. In most cases, connecting a $10\mu\text{F}$ tantalum capacitor in parallel with a $0.1\mu\text{F}$ ceramic capacitor across the load will decouple it. The capacitors should be connected as close to the load as possible.

Series Operation

When converters are connected in series to increase the output voltage, diodes should be added as shown in Figure 17. Choose low forward voltage drop diodes, such as shottky diodes. The reverse voltage of the diode should be greater than the output voltage, and the diode’s turn-on current should be greater than the series load current. The maximum operating output current of the series connection should not be greater than the maximum output current of any single converter.

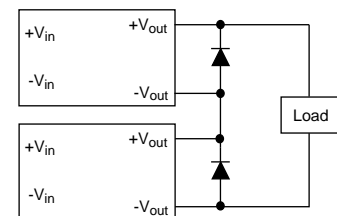

Fig. 17. Series Operation

Parallel Operation

Under most circumstances, paralleling converters is not desirable. When more power is required, a higher power converter will usually use less space and will cost less than using two lower power converters. One common exception is when redundancy or graceful degradation is required. In this case, multiple converters should be used. Please see the discussion on Redundant Operation in the Design Considerations section for further information.

Design Considerations

Parallel Power Distribution

Figure 18 shows a typical parallel power distribution design. Such designs, sometimes called daisy chains, can be used for very low output currents, but are not normally recommended. The voltage across loads far from the source can vary greatly depending on the IR drops along the leads and changes in the loads closer to the source. Dynamic load conditions increase the potential problems.

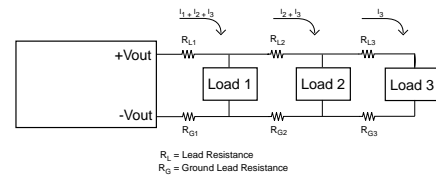

Fig. 18. Parallel Power Distribution

Radial Power Distribution

Radial power distribution is the preferred method of providing power to the load. Figure 19 shows how individual loads are connected directly to the power source. This arrangement requires additional power leads, but it avoids the voltage variation problems associated with the parallel power distribution technique.

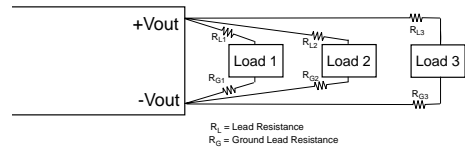

Fig. 19. Radial Distribution

Mixed Distribution

In the real world a combination of parallel and radial power distribution is often used. Dynamic and high current loads are connected using a radial design, while static and low current loads can be connected in parallel. This combined approach minimizes the drawbacks of a parallel design when a purely radial design is not feasible.

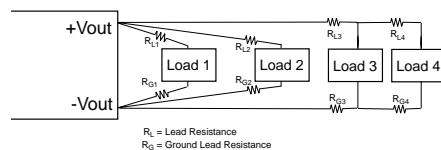

Fig. 20. Mixed Distribution

Redundant Operation

A common requirement in high reliability systems is to provide redundant power supplies. The easiest way to do this is to place two converters in parallel, providing fault tolerance but not load sharing. Oring diodes should be used to ensure that failure of one converter will not cause failure of the second. Figure 21 shows such an arrangement. Upon application of power, one of the converters will provide a slightly higher output voltage and will support the full load demand. The sec-

ond converter will see a zero load condition and will “idle”. If the first converter should fail, the second converter will support the full load. When designing redundant converter circuits, Schottky diodes should be used to minimize the forward voltage drop. The voltage drop across the Schottky diodes must also be considered when determining load voltage requirements.

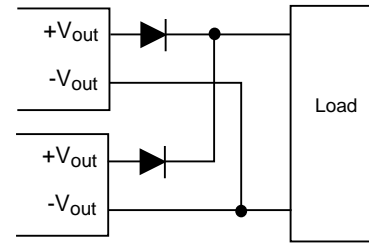

Fig 21. Redundant Operation

Ground Loops

Ground loops occur when different circuits are given multiple paths to common or earth ground, as shown in Figure 22. Multiple ground points can have slightly different potential and cause current flow through the circuit from one point to another. This can result in additional noise in all the circuits. To eliminate the problem, circuits should be designed with a single ground connection as shown in Figure 23.

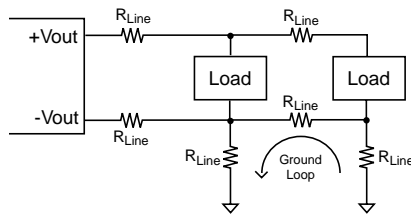

Fig. 22 Ground Loops

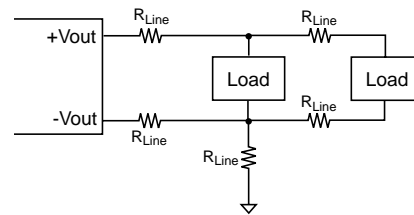

Fig. 23. Single Point Ground

Hot Plugging

When a power source or load is inserted or removed from a system while the system is operational, it is called “hot plugging”. Designing a system for hot plug operation is challenging and several issues should be considered.

The input to a converter is largely capacitive and it will draw a high inrush current when power is first applied. This will place a large demand on the power bus which must be designed to handle the current spike. It also presents the risk of arcing when the converter is connected.

A common way to minimize inrush current is to disable the output until after the inrush current has subsided. Disabling the output eliminates power draw from the converter and reduces capacitor charge times. The output only has to be disabled for a very short time and can usually be done through mechanical connections. Making the input connections physically longer lets them connect first and initiate the inrush current. When the shorter output or output enable connections are made, the inrush has already subsided.

AEV Series Mechanical Considerations

Thermal Derating

AEV single and dual output converters are rated for full power up to a case temperature of 90°C. Under typical conditions this equates to an ambient temperature of 55°C. For operation above ambient air temperatures of 55°C, output power must be derated as shown in Figure 24, or airflow over the converter must be provided. When airflow is provided, the case temperature should be used to determine maximum temperature limits.

The minimum operating temperature for the AEV is -25°C. Operation at temperatures as low as -40°C is possible, but output performance below -25°C is not specified.

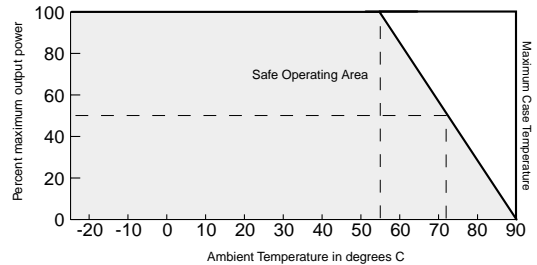

Fig. 24. Temperature Derating

Installation

AEV series converters can be mounted in any orientation, but care should be taken to allow for free airflow. Common placement techniques put heat sources such as power components at the end of the airflow path or provide separate airflow paths. This arrangement keeps other system equipment cooler and increases component life spans.

Soldering

AEV series converters are compatible with standard wave soldering techniques. When wave soldering, the converter pins should be preheated for 20-30 seconds at 110°C, and wave soldered at 260°C for less than 15 seconds.

When hand soldering, the iron temperature should be maintained at 450°C and applied to the converter pins for less than 5 seconds. Longer exposure can cause internal damage to the converter. Cleaning can be performed with cleaning solvent IPA or with water.

AEV 24V&48V Input Series DC-DC Converters Single And Dual Output, 25W DC-DC Converters

	Electrical Specs												
	Nominal Input (V)	Output Voltage (V)	Output Current (A)	Short Circuit Current (A)		Ripple (mV rms)		Noise (mV pp)		Efficiency (%)		Oversoltage Lockout (V)	
				typ	max	typ	max	typ	max	min	typ	min	max
AEV05F24	24	3.3	5	6.7	10	20	50	75	78	80	3.96	5.0	
AEV04A24	24	5	4	5.3	10	20	50	75	82	83	5.75	7.0	
AEV02B24	24	12	2.1	2.9	10	20	75	100	83	85	13.8	15.5	
AEV02C24	24	15	1.7	2.6	10	20	75	100	83	86	17.0	19.5	
AEV05F48	48	3.3	5	6.7	10	20	50	75	78	80	3.96	5.0	
AEV04A48	48	5	4	5.3	10	20	50	75	82	83	5.75	7.0	
AEV04N48	48	6	4.1	5.4	10	20	50	75	84	86	7.0	8.0	
AEV02B48	48	12	2.1	2.9	10	20	75	100	83	86	13.8	15.5	
AEV02C48	48	15	1.7	2.6	10	20	75	100	83	86	17.0	19.5	
AEV02AA24	24	±5	±2	6.6	10	20	50	75	82	83	12	14	
AEV01BB24	24	±12	±1.05	3.4	10	20	75	100	84	86	27	33	
AEV01CC24	24	±15	±0.85	3.2	10	20	75	100	84	86	33.5	42	
AEV02AA48	48	±5	±2	6.2	10	20	50	75	82	83	12	14	
AEV01BB48	48	±12	±1.05	2.9	10	20	75	100	84	86	27	33	
AEV01CC48	48	±15	±0.85	2.7	10	20	75	100	84	86	33.5	42	

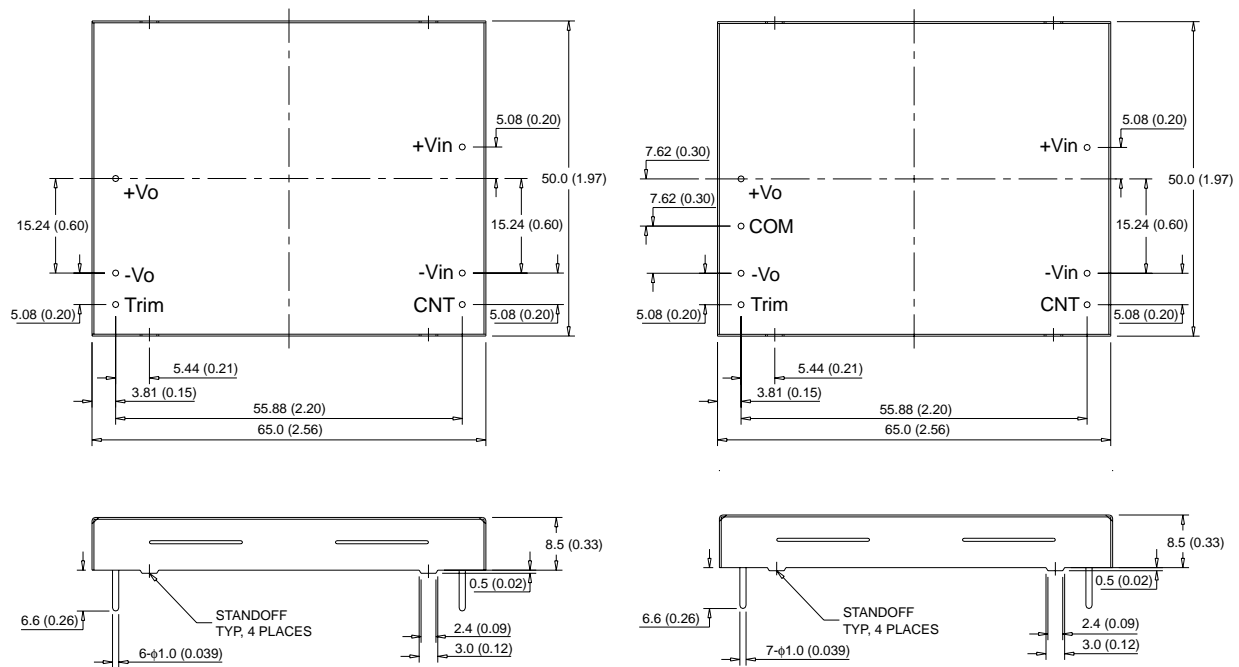

Tolerances:
 Inches: .xx ±0.020, .x ±0.5, .xxx ±0.010
 Millimeters: .x ±0.5, .xx ±0.25

AEV Single and Dual Mechanical Chart (pin side view)

**AEV 24V&48V Input Series DC-DC Converters
Single And Dual Output, 25W DC-DC Converters**

Input	Common Specs				Units	Notes
	Min	Nom	Max			
Input Voltage	18	24	36		Vdc	50 Vdc max < 100 ms
	36	48	72		Vdc	100 Vdc max < 100 ms
Isolation						
Input-Output	500				Vdc	
Input-Case	500				Vdc	
Output-Case	500				Vdc	
I/O Isolation Resistance	300				MΩ	
Control Voltage			80		Vdc	absolute maximum
Control Logic						
Logic Low = On			3.0		Vdc	
Logic High = Off	7				Vdc	
Control Current			1.4		mA	
Undervoltage Shutdown						
24 Vin	14	16	18		Vdc	
48 Vin	30	33	36		Vdc	
Overvoltage Shutdown						
24 Vin	36	38	42		Vdc	
48 Vin	72	76	82		Vdc	
Output						
Power			25		W	
Voltage Setpoint Accuracy			±1		%Vo	
Line Regulation		±0.05	±0.2		%Vo	
Load Regulation		±0.35	±0.5		%Vo	
Trim Range	-10		+10		%Vo	Both outputs trim together.
Dynamic Response						
50-75% load			5		%Vo	T=25°C, di/dt=1A/10µs
			200		µs	T=25°C, di/dt=1A/10µs
50-25% load			5		%Vo	T=25°C, di/dt=1A/10µs
			200		µs	T=25°C, di/dt=1A/10µs
Temperature Regulation			±0.02		%Vo/°C	
General						
MTBF		2,030			k Hrs	Bellcore TR332, 25°C
Case Temperature	-25		90		°C	
Storage Temperature	-45		85		°C	
Switching Frequency		330			kHz	
Pin solder temperature			260		°C	wave solder < 15 s
Hand Soldering Time			5		s	iron temperature 450°C
Weight		63			grams	

AEV 24V&48V Input Series DC-DC Converters Single And Dual Output, 25W DC-DC Converters

AEV Single Performance Curves (rated input voltage, full load, at 25 °C)

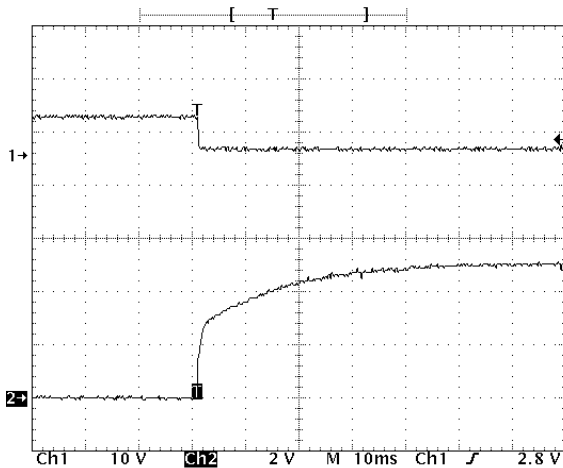
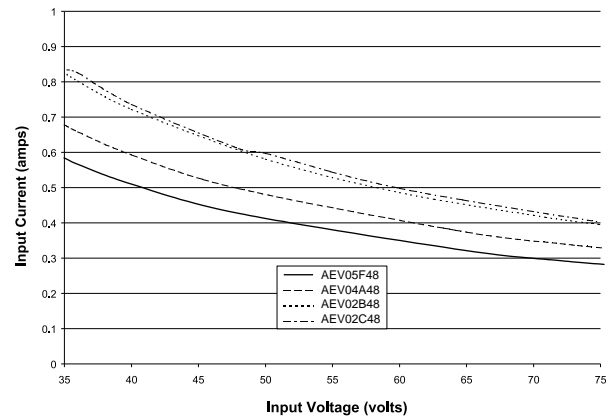
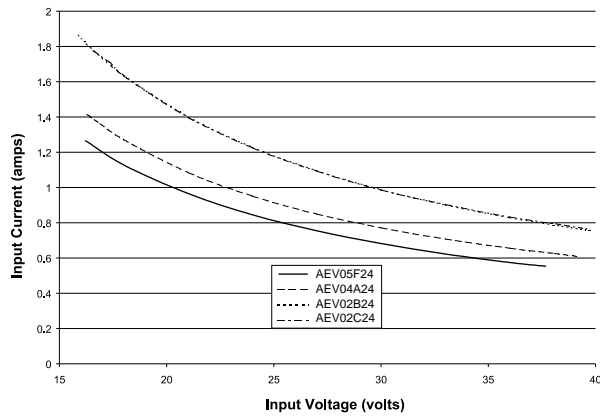
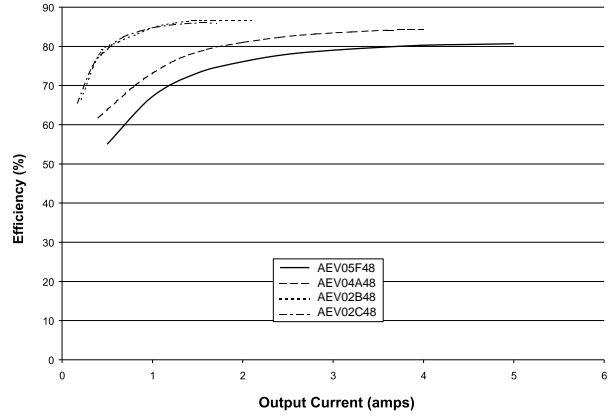
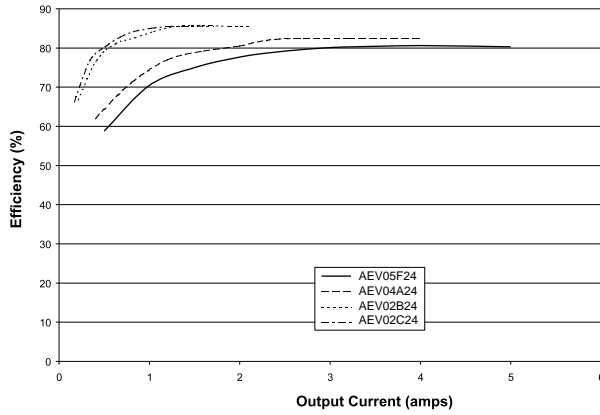

AEV Single Output Typical Startup Delay from CNT On

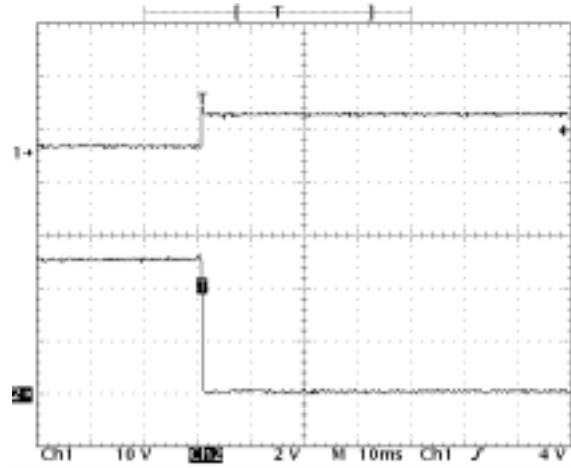

AEV Single Output Typical Shutdown Delay from CNT Off

AEV 24V&48V Input Series DC-DC Converters Single And Dual Output, 25W DC-DC Converters

AEV Single Performance Curves (rated input voltage, full load, at 25 °C)

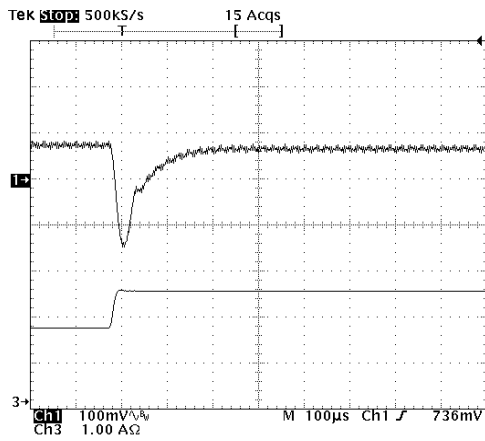
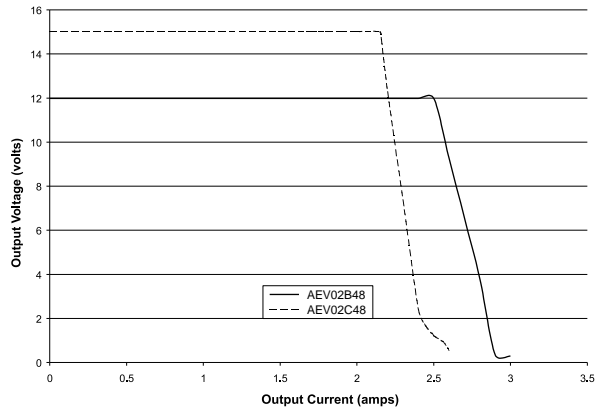
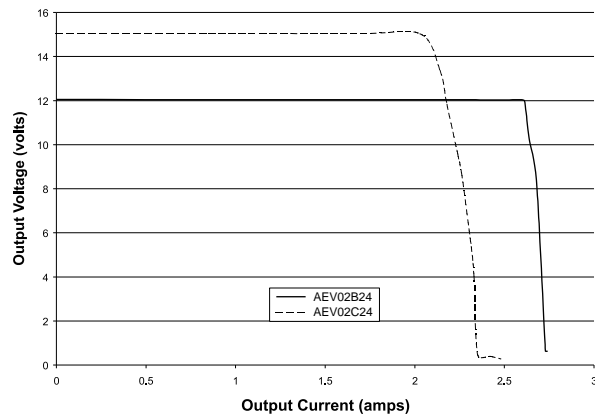
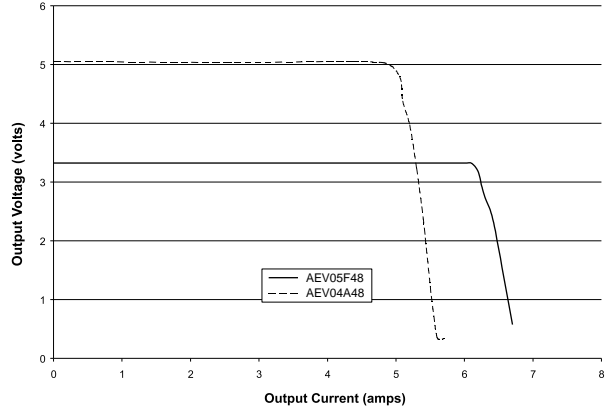
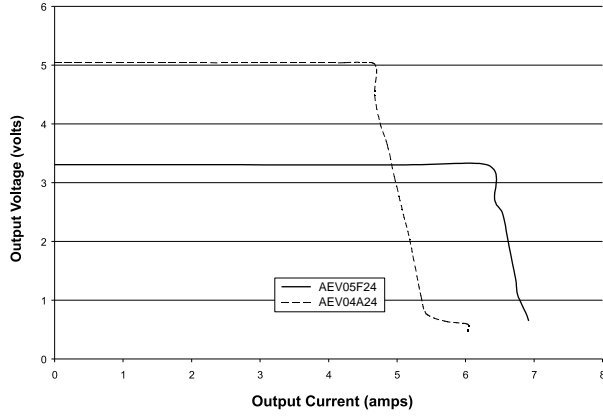

Typical step up load response from 50% to 75% load.
AEV04A48

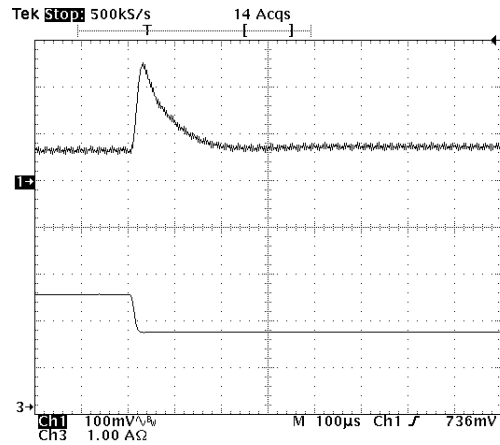

Typical step down load response from 50% to 25% load.
AEV04A48

AEV 24V&48V Input Series DC-DC Converters Single And Dual Output, 25W DC-DC Converters

AEV Dual Performance Curves (rated input voltage, full load, at 25 °C)

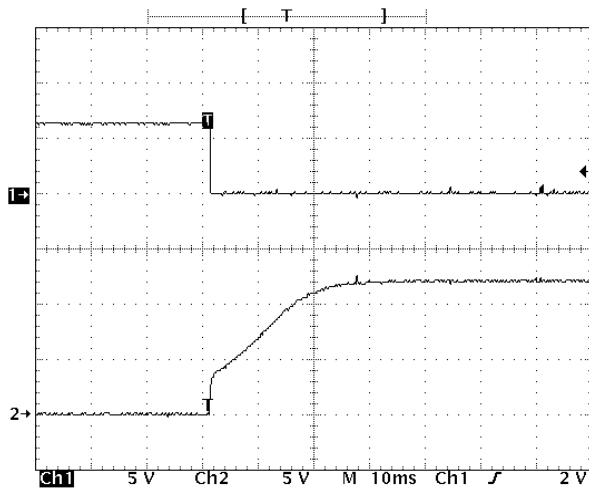
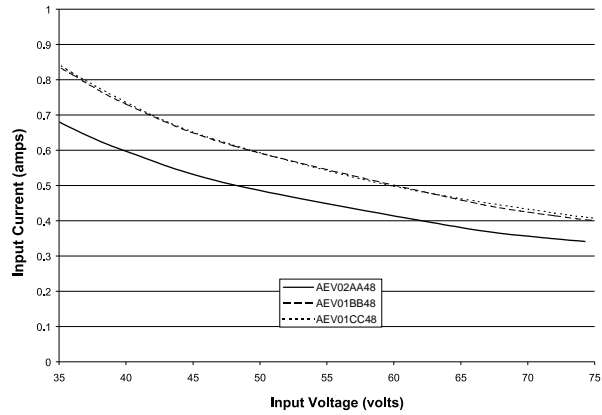
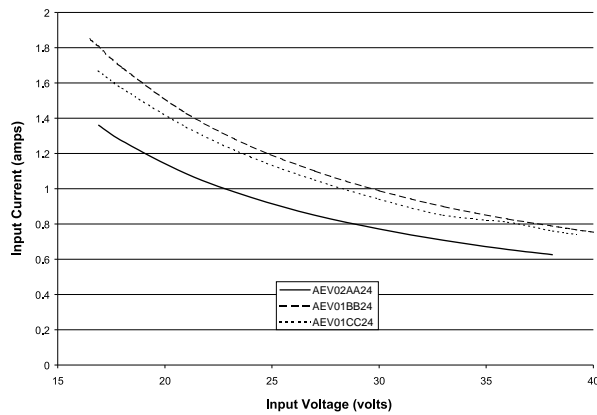
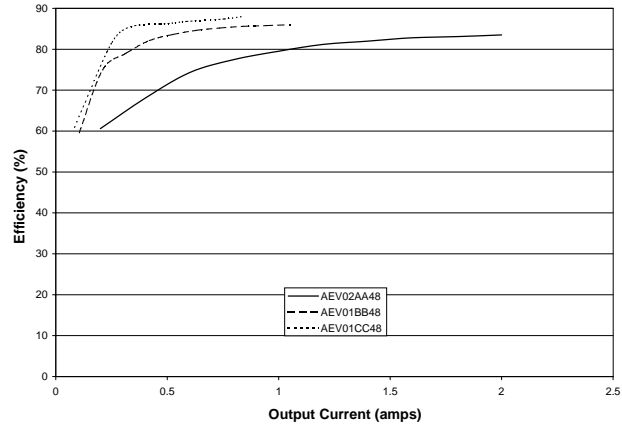
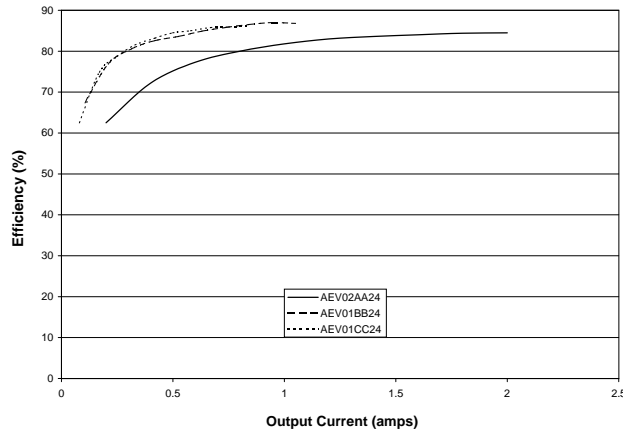

AEV Dual Output Typical Startup Delay from CNT On

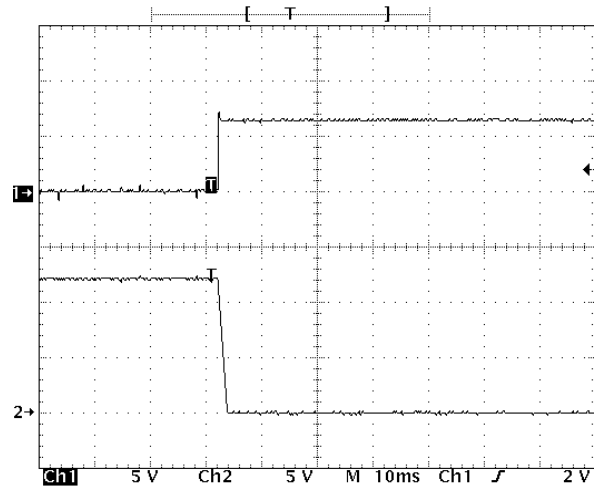

AEV Dual Output Typical Shutdown Delay from CNT Off

AEV 24V&48V Input Series DC-DC Converters Single And Dual Output, 25W DC-DC Converters

AEV Dual Performance Curves (rated input voltage, full load, at 25 °C)

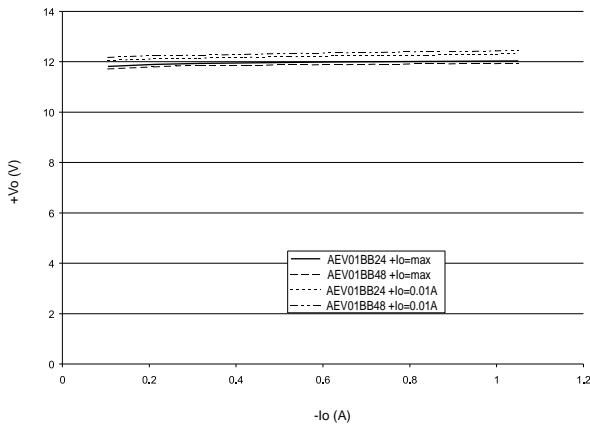
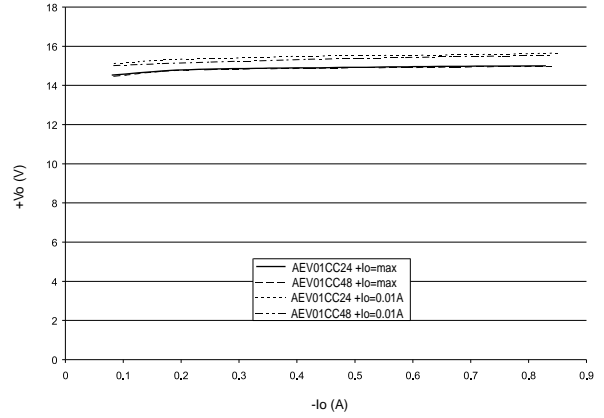
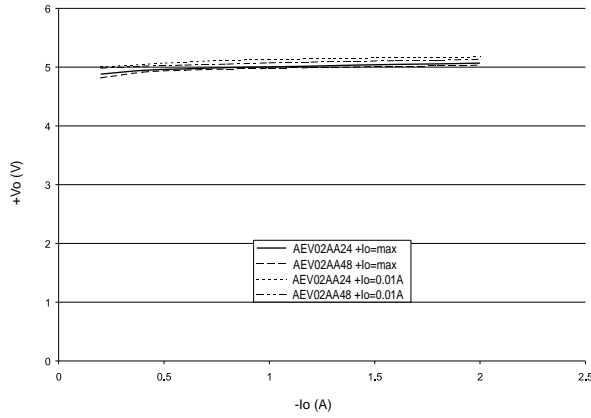

PART NUMBER DESCRIPTION

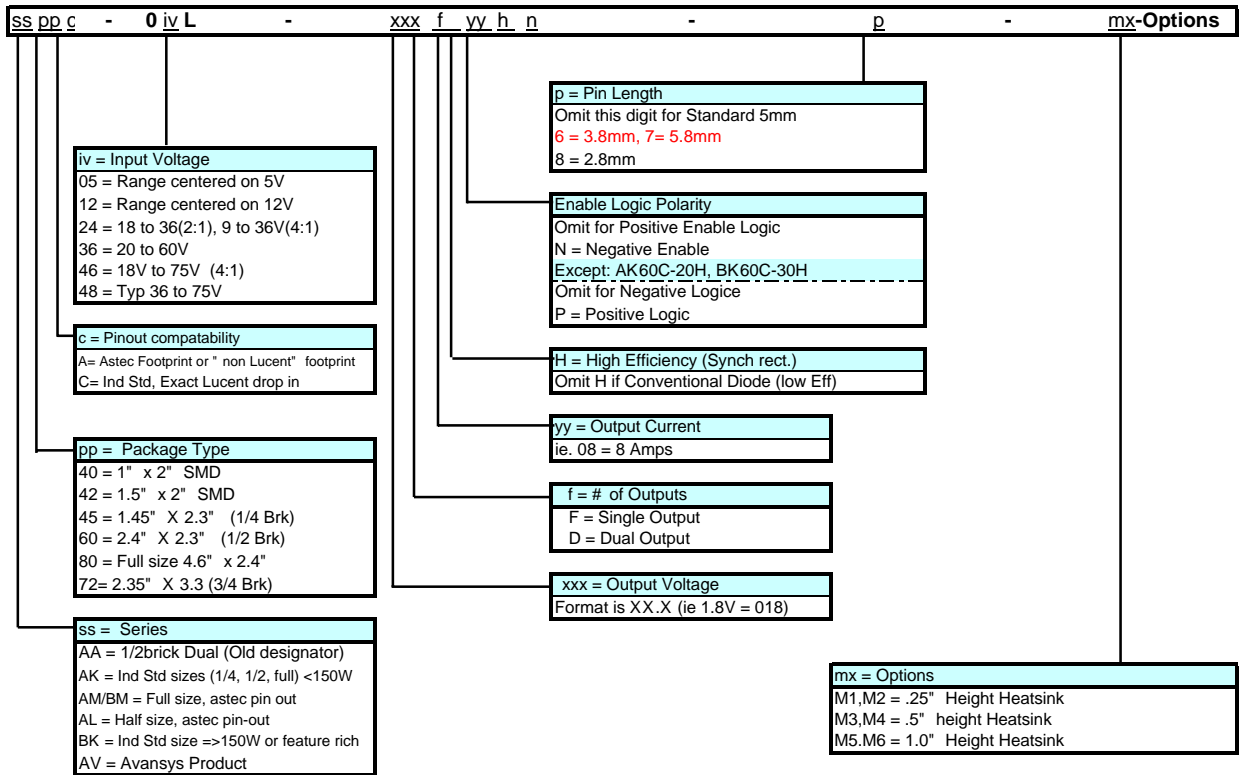

Note: For some products, they may not conform with the PART NUMBER DESCRIPTION above absolutely.

NEW PART NUMBER DESCRIPTION

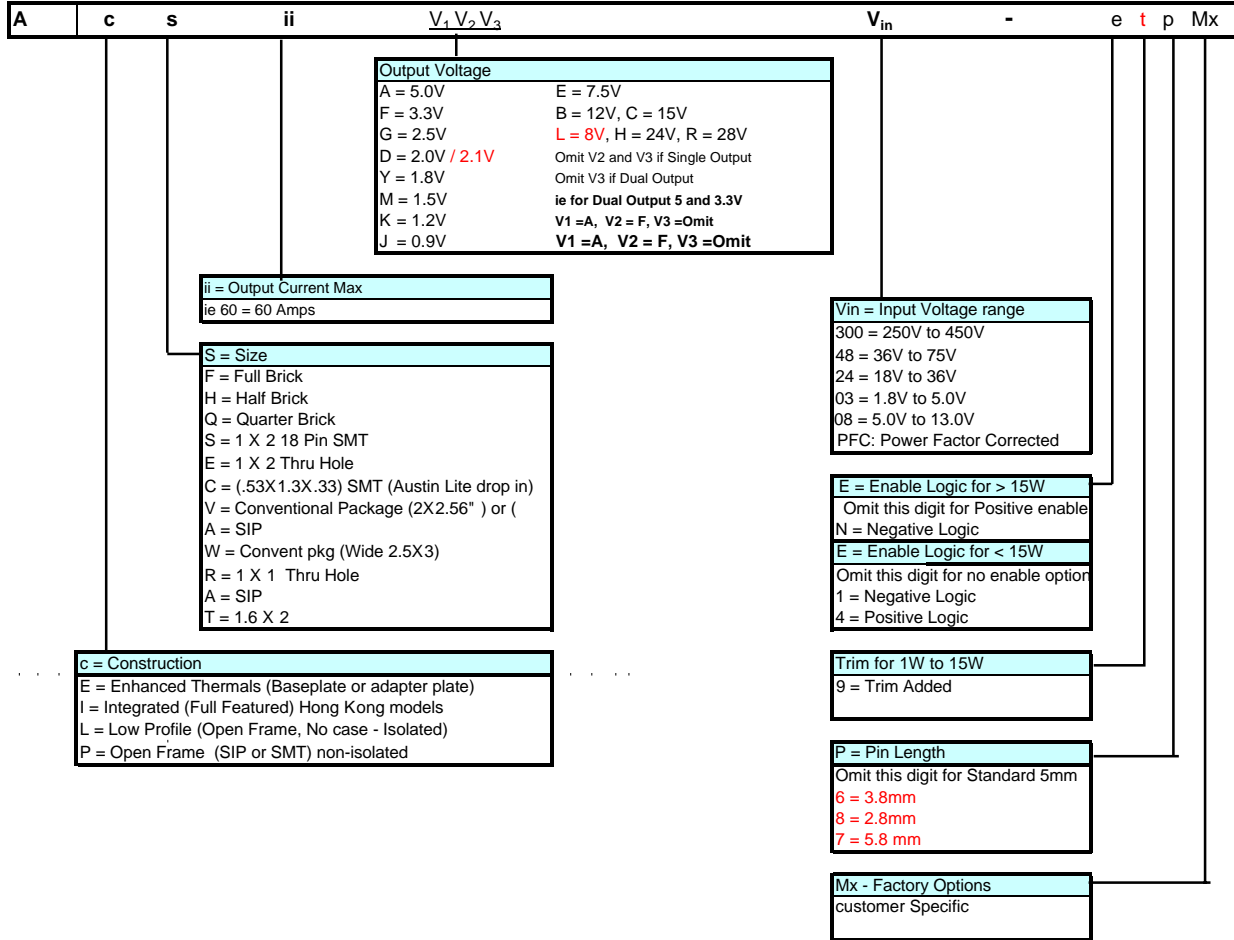

Note: For some products, they may not conform with the NEW PART NUMBER DESCRIPTION above absolutely.