

F9J GCB I

BCH9G

%<889B @B9G5F9I G98 'HC G<CK DC 5F#5HC B
K <9B I GB: 'IB' C DHC B".....
 &' Q'F9DF9G9BHG'5'7F#7 5@8A 9BGC'B"
 "": G8'756@5GG9A 6@9G5F9 @958':F99"
 ("5@5GG9A 6@9GHC '69%'\$! '9@7HF=7 5@MH9G#98)
 "": CF'G<CFHG'5B8'CD9B'G'
)"5@5GG9A 6@9GHC '69%'\$! '<4DC H#9G#98 '5H*' '\$J"
 **"GF5-B'F9@9: 'HC' K' #k'GH5B8')@6Q&BQG#5= <HDI @

8C' BCH
 G75@: FCA
 Hk-GDF-BH

:: G8!LL!L!LL "LL!\$%L!L!LLL

Bc'C: DC GHC BG
 !S&H'F'!&
FD9F FCK E

9B8'5GG9A 6@M
 !G'GB: @9B8
 !B: 8C I 6@9B8

5GG9A 6@M@9B: Hk
 fB"\$SQ \$", QA 'B-A I A E

@958'GHM@9

D@5HB: 'C DHC BG
 !' @95J 96@5B?: C F'GH5B85F8Z I G97!'+!@
 !G' I G97!'+!G
 !: I G97!'+!:
 !' 1' B'CHF9@95G98: CF'DFC8I 7HC B

C DHC B

!FK: F9J 9F9G K #B;
 !8'LL": 85'GM7 <5-B'fA 'B-A I A '&'\$SQ \$", Q
%\$\$Q&)"(Q' B7 F9A 9BHC

!F: F9J 9F98
 !FB%'F9J 9F9G DC 5F#5HC B'BC H7 <
 !FA' 'A' -88@F9J 9F9G
 !C: 'C I' HG89F9J 9F9G
 !GF: 'GF5-B'F9@9:

!f: fBCH5J 5@56@9B' #k' !Q'IC ZIA Z
!FZCF'!8LL
fGC @B'5G5GG9A 6@9GC B@M

GH5B85F8'DC 5F#5HC B'BC H7 <
 !B: DC 5F#5HC B'BC H7 <
fBCH5J 5@56@9B' !S&H'F' !S' (E
f@95J 96@5B?: C F' !S&Z' \$' Z!S' (E

: = "%
 fl: G8!%\$!8!LL"LL!\$%L!B'G<CK B E

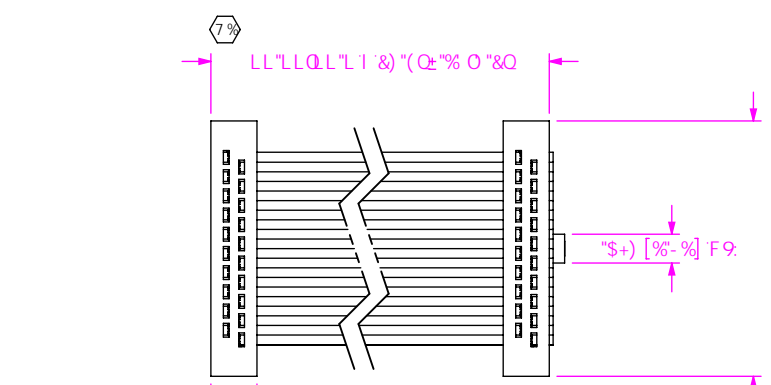

7) "%&\$ [' '\$] F9.
 7) fBc'C: DC GI "'\$) \$O%&+Q'Z' "%) Q' "% QF9.

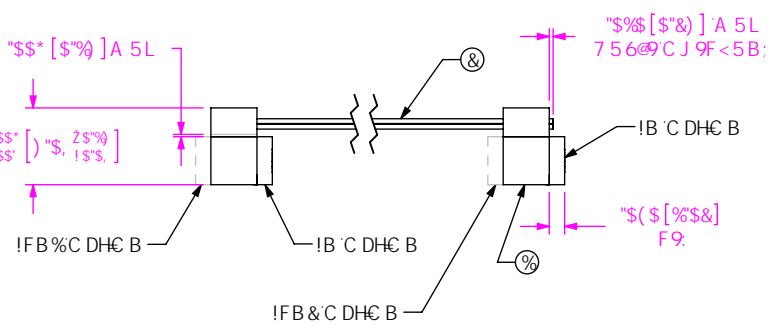

7C @ F98 K #9HC 'G89
 C: : fGHDC G' B8=75HC F
 ! 7C @ F98 K #9A 5M69
 6@57?Z6@ 9ZCF F98"

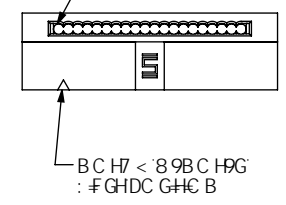

: = "'&
 fl: G8!%\$!G!LL"LL!\$%L!B'G<CK B E
 fG5A 95G: = "%Z8=: 9F9B H5G'G<CK B E

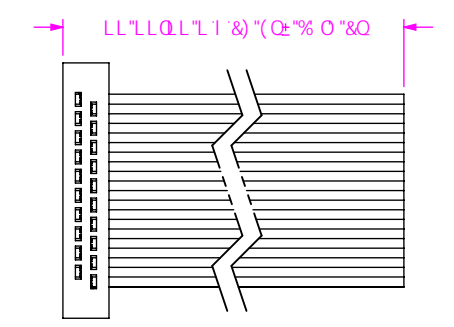

: = "'
 fl: G8!%\$!L!LL"LL!\$%L!B'fK' G<CK B E

7C @ F98 K #9HC 'C DDC G#9
 G89C: : fGHDC G' B8=75HC F

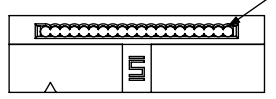

TABLE 1	
ITEM #	PART
1	FFSD-XX-01-X-N-XX
2	CB-XX-30-7/38-025-GR
3	FFSD-XX-01-X-N-SR
4	FFSR-XX

WPYbH'fd'f'g'j UI 1P8K : PA 47 PA 7H P.: G8!LL!L!LL"LL!\$%L!L!LLIA 7HG@8'8FK

I B @9G: C H: 9F K #9' @97 = 98Z
 8-A 9BGC BG'5F9-B' B7 <9G'
 HC @9F5B7 9G'5F9.
 897 A 5@G5B: @9G
 "LL: ±"\$% O' O'&
 "LLL: ±"\$S) O' O
 "LLLL: ±"\$S&\$ O\$) %Q

DFC DF-9H5FMBC H9
 H: G8C 71A 9B H7 C B16 8G B: CFA 5HC B
 7C B: 89B H6 @5B8 DFC DF-9H5FMBC
 G5A H7 Z B7 *5B8 G: 5@B C H69 F90FC 8I 7 9B
 C F H5BG 9F98 HC C H: 9F BC 71 A 9B HG C F
 8 47 @C 98 HC C H: 9F C F I 98: C F 5BM
 DI FDC 09 C H: 9F H: 5B H: 5HK <7 < Hk 5G
 C 6: 5 8 9 K #k C I Hk 9 9L DF 9G98 K F #H8
 7 C B 98 HC: G5A H7 Z B7 "

A 5HF-5@ 8C' BCH G75@9 8F5K B: G: 99HG7 5@9. &%
 #G' @5HC FG' D6H7 C @C F: '6@57?
 7 C B16 7 H 6Y7 I
 756@9: HB B98 7 C DD9F Z7 C @C F.: F5M
 D@5HB: "\$\$\$S\$: C @B C J 9F "\$\$\$\$) \$ B-7?9@
 F9A 5-B 8 9F: "\$\$\$S\$ F9: HB' C J 9F "\$\$\$\$) \$ B-7?9@

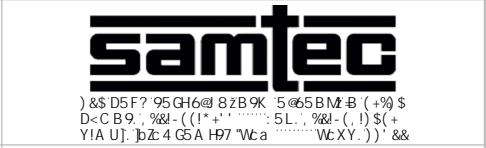

89G7 F@HC B.
 "\$) \$1 "\$) \$8C I 6@9FCK : 9A 5@-87'5GG9A 6@M
 8K: "BC"
 :: G8!LL!L!LL "LL!\$%L!L!LLL
 6M HB9K HC B \$&#?%) #&\$\$, G<99H% C: '

F9J €€ B 11

fi: G8!%\$!8!LL"LL!%\$!LB!FB%G<CK BŁ
fG5A 9'5G: ÷ "%ž8 ÷: 9F9BH5GG<CK BŁ

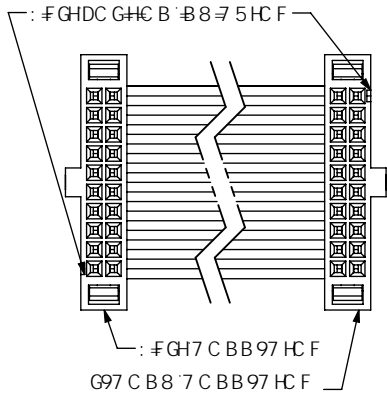

G97 CB8 7 CBB97 HC F

fi: G8!%\$!8!LL"LL!%\$!LB!FB%G<CK BŁ
fG5A 9'5G: ÷ "%ž8 ÷: 9F9BH5GG<CK BŁ

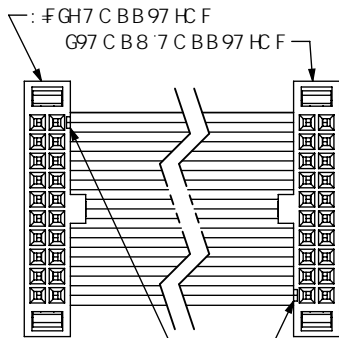

G97 CB8 7 CBB97 HC F

: FGHDC G#C B 'B8 7 5HC F

BC H9.
!FB%1 F9J 9F9BCH7 < C B %GH7 CBB97 HC F C B @M
..... f B C H 5 J 5 6 9 K # k ! F C D H C B Ł
!FB&1 F9J 9F9BCH7 < C B 'B8 7 CBB97 HC F C B @M
..... f B C H 5 J 5 6 9 K # k ! F C D H C B Ł

fF9J 9F9BCH7 < B C H 5 J 5 6 9 K # k ! F K ' C F 5 B M
85 6 M 7 < 5 B C D H C B Ł

fi: G8!%\$!8!LL"LL!%\$!LB!8LL!G<CK BŁ
fG5A 9'5G: ÷ "%ž8 ÷: 9F9BH5GG<CK BŁ
fB'\$SQ \$", OA -B-A I A Z%\$SQ) "(Q-B 7 F9A 9BHŁ

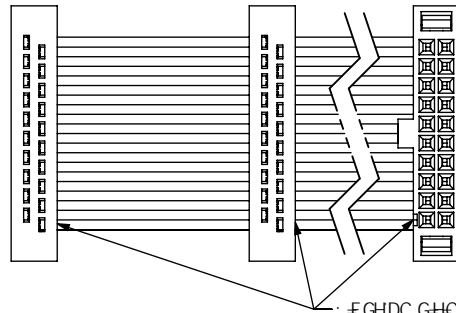

: FGHDC G#C B 'B8 7 5HC F

LL"LLQL'L I &)"(Q%"O"&Q
fA B & Ł

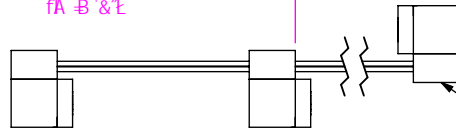

C I HG8 9 7 CBB97 HC F F9J 9F98 K < 9B '85 6 M 7 < 5 B 98

fi: G8!%\$!8!LL"LL!%\$!LB!8LL!G<CK BŁ
fG5A 9'5G: ÷ "%ž8 ÷: 9F9BH5GG<CK BŁ
fB C H 5 J 5 6 9 K # k !FB%CF !FB&C DHC B Ł
fB'\$SQ \$", OA -B-A I A Z%\$SQ) "(Q-B 7 F9A 9BHŁ

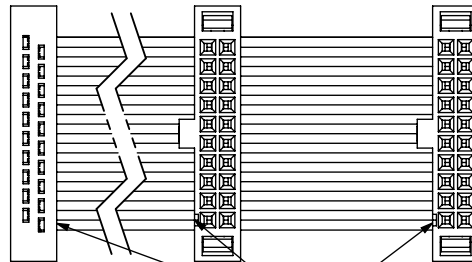

: FGHDC G#C B 'B8 7 5HC F

LL"LLQL'L I &)"(Q%"O"&Q
fA B & Ł

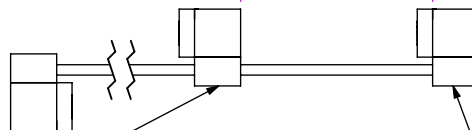

: 6C H 7 CBB97 HC F F9J 9F98 K < 9B '85 6 M 7 < 5 B 98

fi: G8!%\$!8!LL"LL!%\$!LB!8LL!G<CK BŁ
fG5A 9'5G: ÷ "%ž8 ÷: 9F9BH5GG<CK BŁ
fB'\$SQ \$", OA -B-A I A Z%\$SQ) "(Q-B 7 F9A 9BHŁ

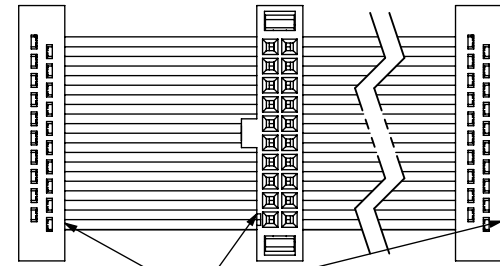

: FGHDC G#C B 'B8 7 5HC F

LL"LLQL'L I &)"(Q%"O"&Q
fA B & Ł

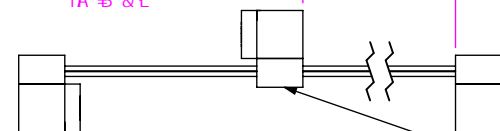

A -B8 @ 7 CBB97 HC F F9J 9F98 K < 9B '85 6 M 7 < 5 B 98

fi: G8!%\$!8!LL"LL!%\$!LB!8LL!G<CK BŁ
fG5A 9'5G: ÷ "%ž8 ÷: 9F9BH5GG<CK BŁ
fB'\$SQ \$", OA -B-A I A Z%\$SQ) "(Q-B 7 F9A 9BHŁ

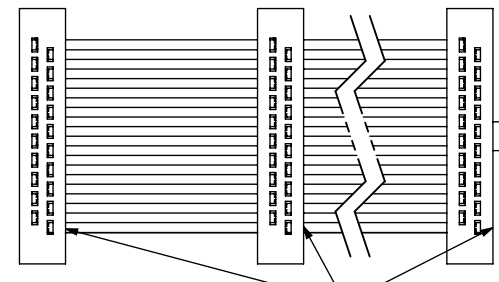

: FGHDC G#C B 'B8 7 5HC F

LL"LLQL'L I &)"(Q%"O"&Q
fA B & Ł

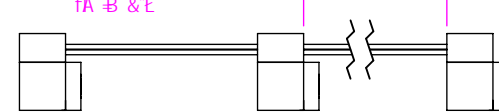

D F C D F 9 5 F M B C H 9
H: 6 B C 7 I A 9 B H 7 C B I B B G B: C F A 5 H C B
7 C B: 8 9 B H 5 B 8 D F C D F 9 5 F M B C
G S A H 7 2 8 7 5 B 8 G: 5 M B C H 6 9 F 9 0 F C 8 1 7 9 8
C F H 5 B G 9 F 9 8 H C C H: 9 F 8 C 7 I A 9 B H C F
8 4 7 @ 9 8 H C C H: 9 F G C F I 9 8: C F 5 B M
D I F D C 9 C H: 9 F H: 5 B H: 5 H K < 7 < # K 5 G
C 6 1 5 B 9 8 K # k C I H H: 9 9 L D F 9 0 9 8 K F # 9 8
7 C B 9 8 H C: G S A H 7 2 8 7 *

8 C 'B C H G 7 5 @ 8 F 5 K B:

G: 9 9 H 7 5 @ 9 & %

samtec

)& D5F? 95GH6@ 8ZB9K 5@5BM.B (+)% \$
D<C B 9; %&L - ((! * + SL; %&L - () \$ (+
YIA UJ; j z: 4 G S A H 7 W c a W X Y .) ' &&

8 9 6 7 F @ H C B.
"\$) \$1 "\$) \$ 8 C I 6 @ F C K : 9 A 5 @ 8 7 5 G 3 9 A 6 @ M

8 K: " B C "

:: G8!LL!L!LL"LL!%\$!LB!L!LL

6 M H B 9 K H C B \$ & # / 9) # & \$ \$ \$, G < 9 9 H & C : '

