

# Amphenol® 97 Series standard cylindrical connectors

## 151-614 TO 642

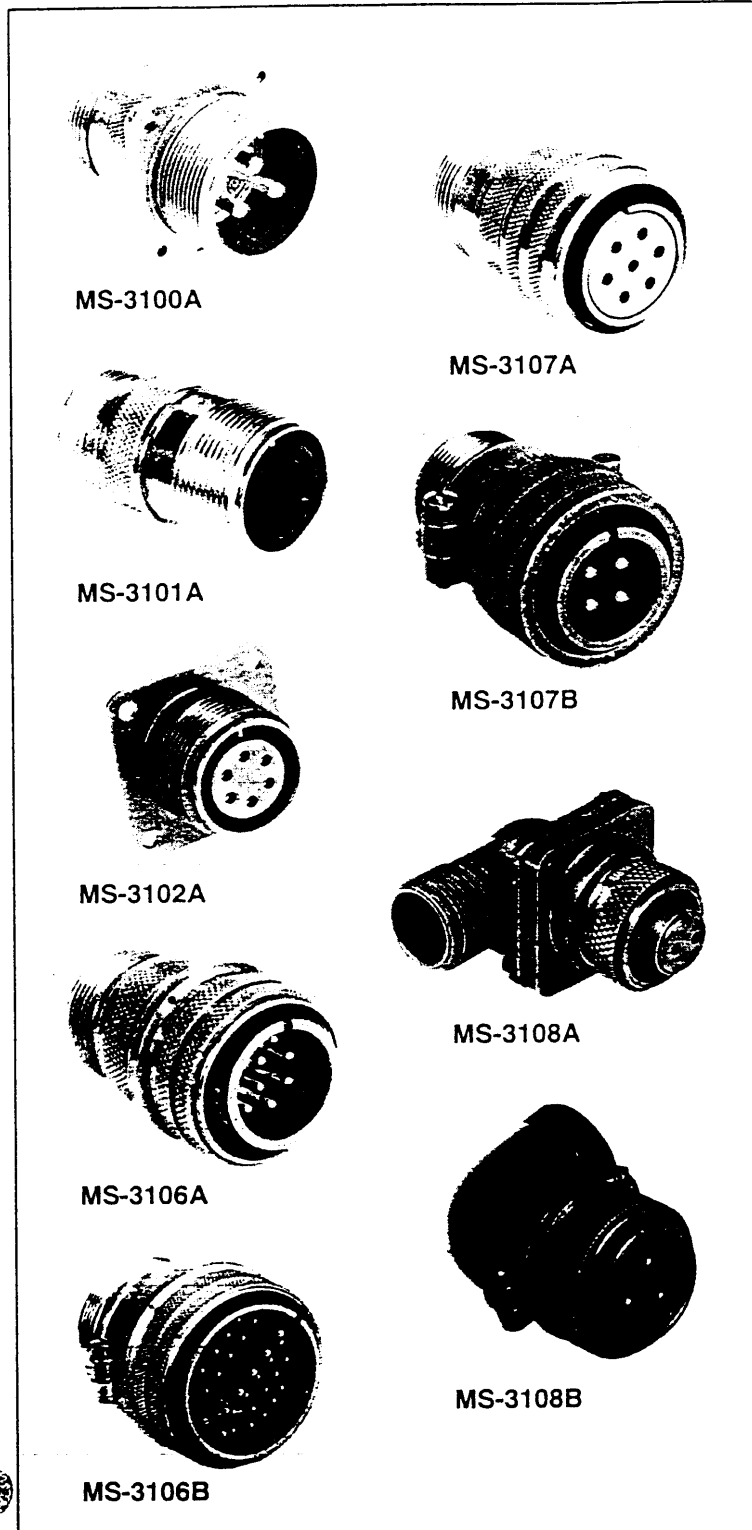

### DESIGN CHARACTERISTICS

- Medium to heavy weight cylindrical
- Durable, field-proven design
- Environment resistant
- Single key/keyway polarization
- Threaded couplings
- Operating temperatures from  $-55^{\circ}\text{C}$  to  $+125^{\circ}\text{C}$
- Cost effective
- Intermateable and intermountable with existing 97 Series and MIL-C-5015 connectors
- Underwriters Laboratories approved recognition File E115497
- Canadian Standards Association Certification File LR69183

### CUSTOMER OPTIONS

- MS or proprietary versions
- Solid or split shell construction
- Six shell styles
- 132 contact arrangements, from 1 to 52 circuits
- Alternate insert positioning
- High temperature and potting constructions
- Special plating finishes
- Optional gold plating on MS contacts
- Thermocouple arrangements available

Shell components are fabricated from high grade aluminum alloy. Electrically conductive cadmium plate finish with olive drab chromate after-treatment offers corrosion resistance. Special finishes include clear cadmium plate or a non-conductive anodized coating with dichromate seal.

Standard MIL-C-5015 contacts are silver plated with pre-tinned solder cups. Optional gold plating on MS contacts is also available. Crimp contacts are rear-release, with closed entry design for size 16.

Inserts are diallyl phthalate, providing high arc and insulation resistance under both humidity and thermal stress.

For additional information on Amphenol® 97 Series connectors, or for special application requirements, contact your local sales office, authorized distributor, or

Amphenol Corporation  
Bendix Connector Operations  
40—60 Delaware Avenue  
Sidney, New York 13838-1395  
Telephone: 607-563-5011

# 97 series standard circular connectors

## selecting a connector

In selecting a connector, it first must be determined if a non-environmental (97 series) type is required.

Then the following 7 steps may be used to formulate a part number.

### **1** How many wires are you going to connect? What gauge?

These two questions are important, because they indicate which insert you need. There are literally hundreds to choose from.

The insert chart illustrates the 132 inserts with 38 inserts most often used are bracketed. Chances are the one you need is there.

Here's an example of how to use the chart. Say you want to connect eight 16-ga. wires. Just find the section of the chart marked 8 contacts. Insert number 20-7 is the one you want because it contains eight 16-ga. contacts and is one of the most often used. The one you choose might depend on your space or voltage requirements. The voltage capacity of each insert is listed under its diagram.

If you have more than one wire size to connect, the method is essentially the same. Actually, the insert configurations for multiple-size wires are a lot more flexible than they appear. That's because you can always solder a smaller wire to a larger contact. However, soldering a large wire to a small contact isn't recommended because of size and current requirements.

### **2** What if several identical connectors have different functions?

Here's a situation to watch out for. You have four identical receptacles on a panel. One carries high current loads. The others have low current functions. A plug mated with the wrong

receptacle (cross-mating) could ruin your valuable equipment.

To avoid cross-mating, you can order identical inserts positioned in both the plugs and receptacles at various angles from standard. These variations from standard position are called Alternate Insert Positions.

### **3** What kind of receptacle do you need?

**for wall mounting.** Use a Wall Receptacle, type 3100. The elongated back of this receptacle extends through thick wall material. It is threaded to accept standard hardware fittings.

**for unmounted applications.** Use the Cable Receptacle, type 3101.

**for box or panel mounting.** Use the Box Receptacle, type 3102. This receptacle's back is short to conserve space. It is not threaded on the back end and is used when no accessories such as clamps are needed.

### **4** What kind of plug do you need?

**for ordinary situations.** The Straight Plug, type 3106 meets most connector requirements. However . . .

**when space is critical.** You may want to consider using an Angle Plug, type 3108. This type plug lets the cable enter your equipment at a right angle.

### **5** Do you need a plug with Solid or Split Back Shell?

You can get both straight and angle plugs in solid or split back shell designs. With the solid shell, you have greater strength. You save space, too. On the other hand, the split shell design lets you quickly inspect the solder terminals when you need to. This feature could be pretty important if you'll be subjecting the connector to

rough handling and heavy use.

The type identification for solid shell construction is the letter A immediately after the main shell type number: i.e.: 3106A or 3108A. Likewise, the type identification for split back shell construction is B: i.e. 3106B or 3108B. Because of application, receptacles are made in solid back shell construction only. Their type identification is 3100A, 3101A and 3102A.

### **6** Which connector gets the socket? The receptacle or the plug?

You're at the point where you designate which inserts are used with which shells. Since either pin or socket inserts can be used with plugs or receptacles, now's the time to make your choice.

Here's a good rule of thumb. Order the sockets for the connector at the "hot" side of the circuit. By having sockets at the power source, there's little chance that a wayward finger or screwdriver will short the circuit or cause personal injury.

The code of Sockets is simply S following the insert code number. For Pins, it is P. Therefore, 20-7P insert would have pin contacts while a 20-7S insert would have socket contacts.

### **7** Do you need a non-reflective finish or a shiny finish?

If you prefer the standard dull-olive cadmium plate finish, which is non-reflective, then no suffix number is needed. If you would rather have the shiny, clear cadmium plate finish, just add the suffix (639) at the end of your part number.

Both finishes give you the same high conductivity and resistance to corrosion.

# MIL-C-5015 or 97 series (solder) how to order

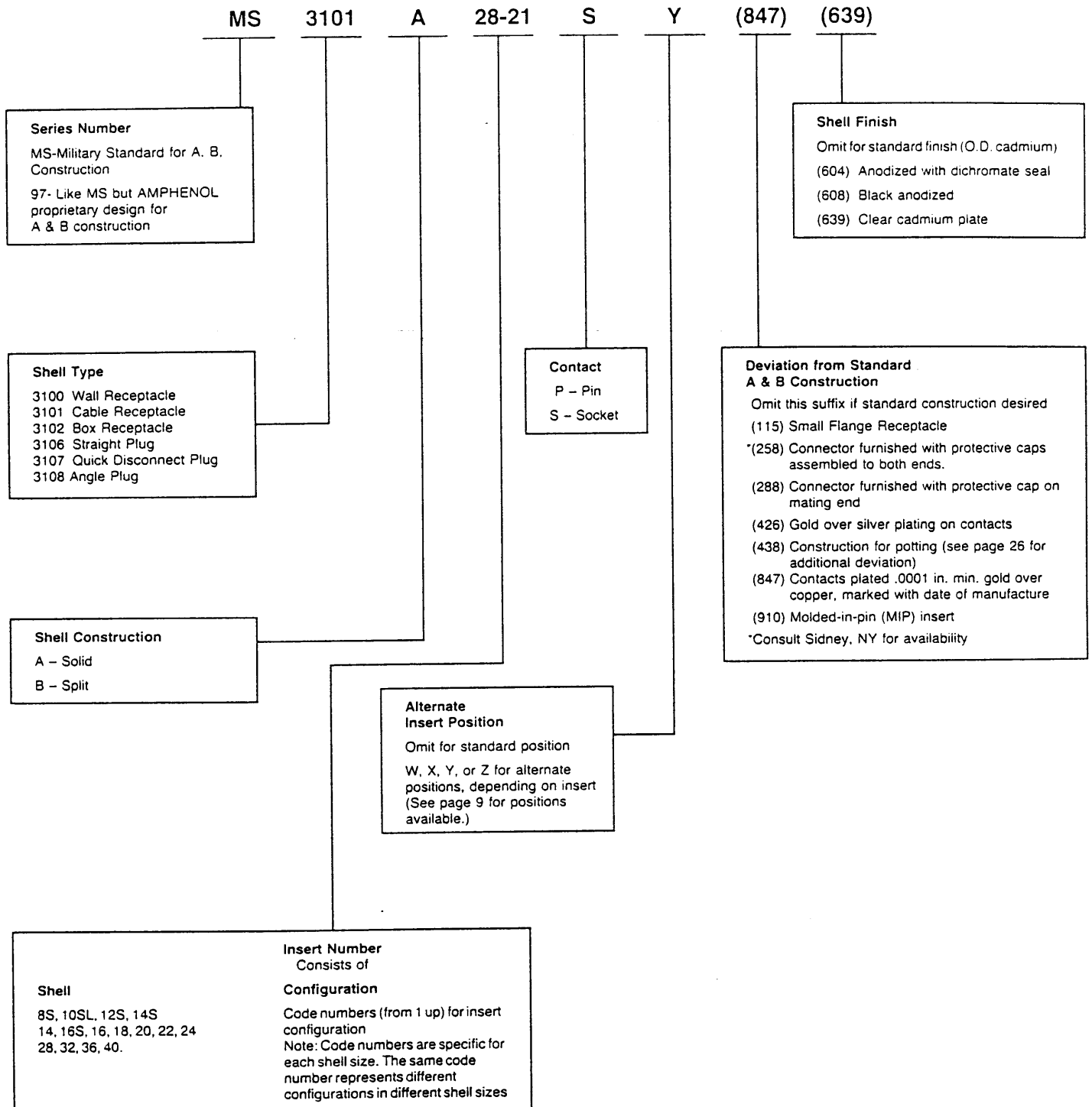

# 97 series MS inserts – contact arrangements (front view pin insert)

Items highlighted by box are most popular and most readily available. For meaning of symbols below, see notes and code of wire sizes on following page.

## 1 contact

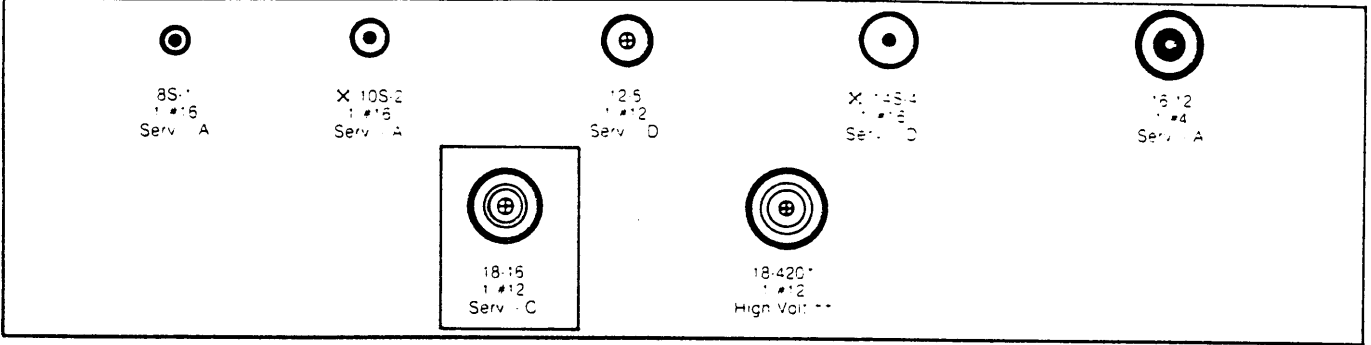

## 2 contacts

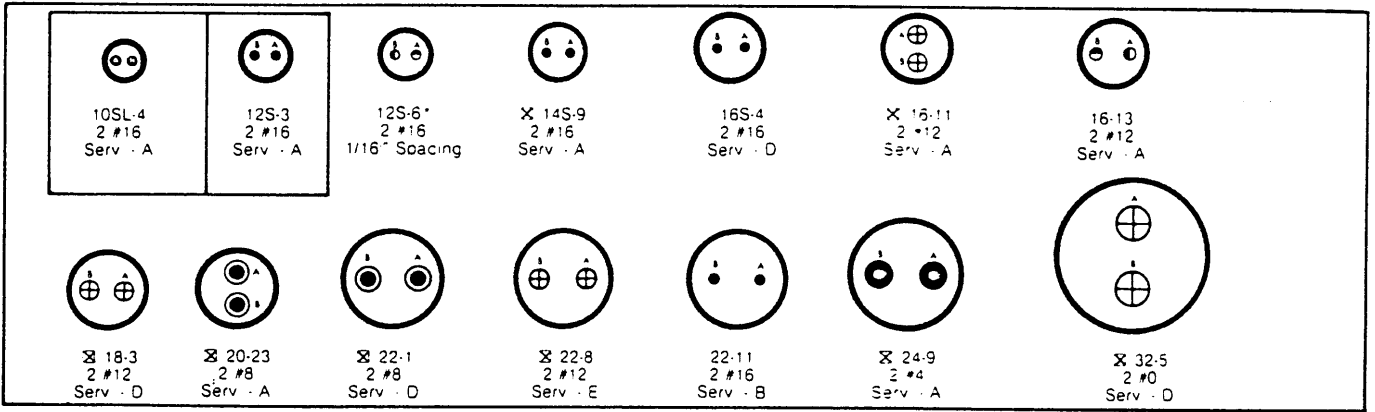

## 3 contacts

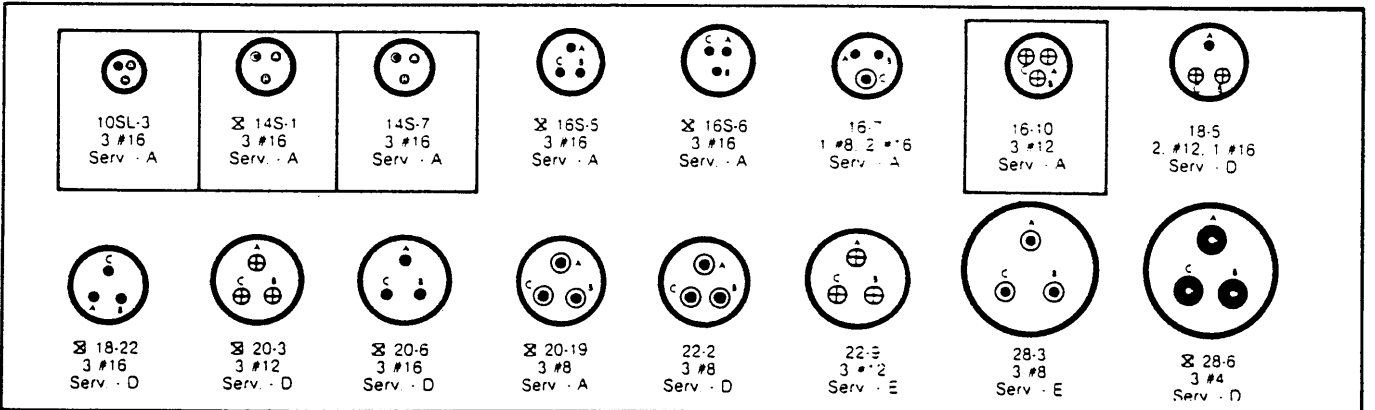

## 4 contacts

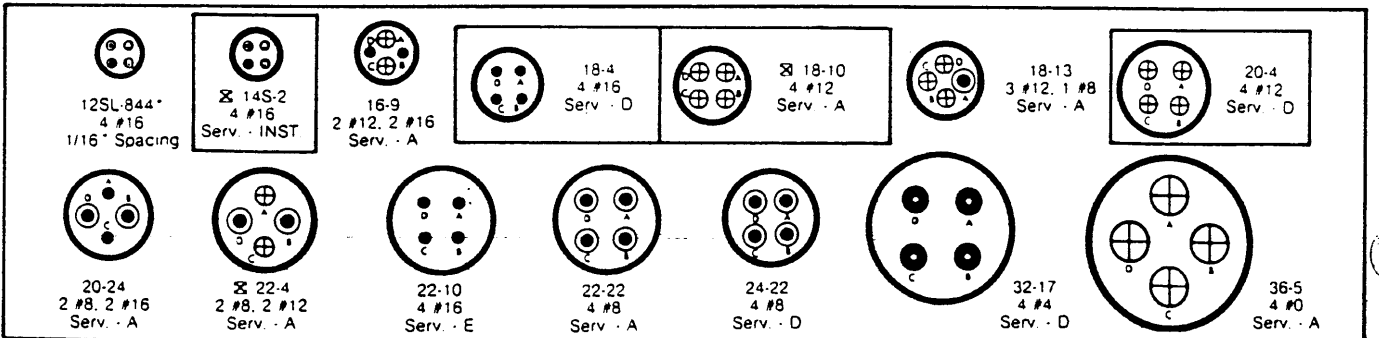

# 97 series MS inserts – contact arrangements (front view pin inserts) (cont.)

## 5 contacts

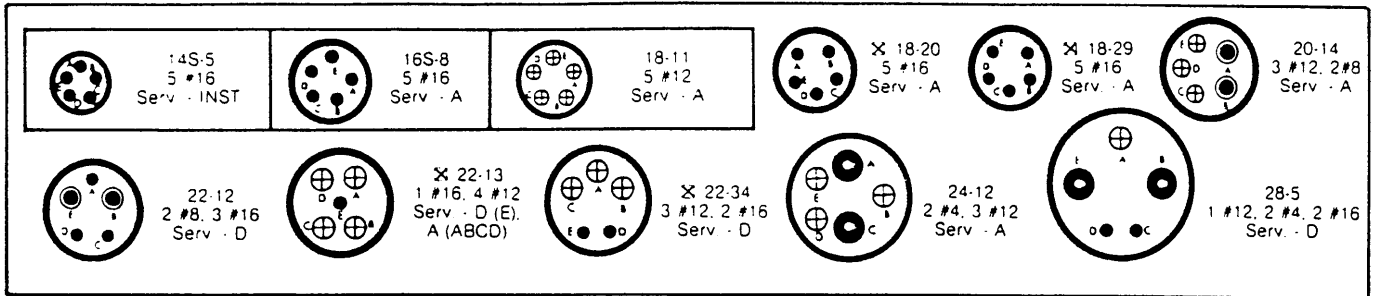

## 6 contacts

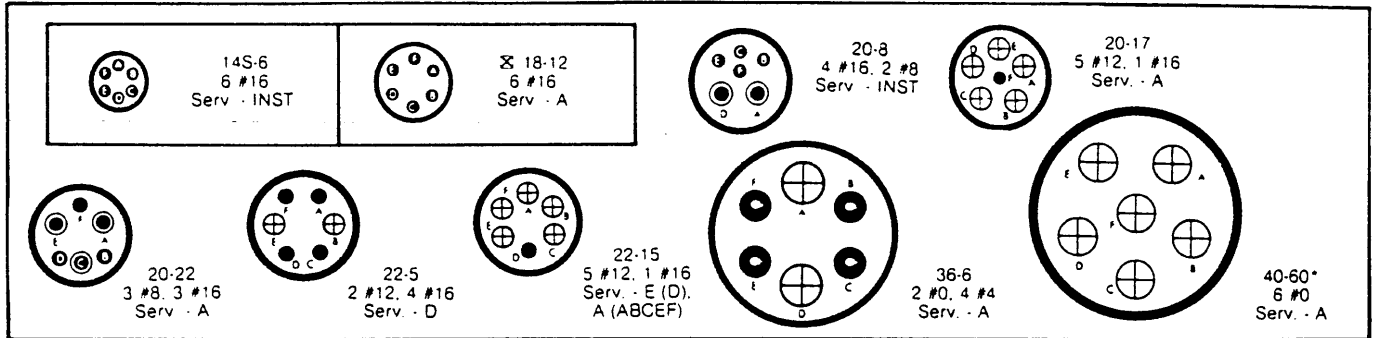

## 7 contacts

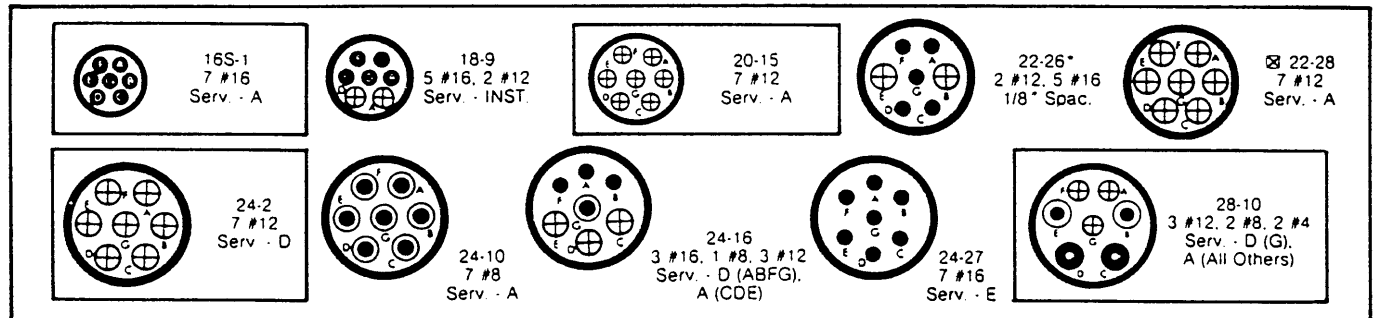

SERVICE		INST	A	D	E	B	C
Limiting Operating Voltages at sea level	DC	250	700	1250	1750	2450	4200
	AC (rms)	200	500	900	1250	1750	3000
Effective Creepage (nominal)	Inch.	1/16	1/8	3/16	1/4	5/16	1
	mm.	1.57	3.18	4.75	6.35	7.92	25.40
Mechanical Spacing (nominal)	Inch	1/16	1/8	3/16	1/4	5/16	
	mm	1.57	3.18	4.75	6.35	7.92	

TEST CURRENT	16	12	8	4	0
Contact Size	16	12	8	4	0
Amperes	13	23	46	80	150

See notes 1 and 2.  
SERVICE CHART above shows Army-Navy ratings for aircraft use.  
INST service normally for low voltages and currents.

NOTE 1. Transients were not considered in calculating these values.

NOTE 2. Limiting operating voltages at 50,000 feet altitude are approximately 25% of the sea level values.

- X Inactive for new military design but available for replacement or for non-military purposes.
- \* Consult Sidney, NY for availability
- \* "MS" number not assigned. Use "97" prefix in place of "MS" in completing catalog number.

†† High Voltage Contact. Rating 24,000 volts DC, 17,000 volts R.M.S., 60 cps at sea level - 41 amps.  
Maximum - in mated condition with connector potted.

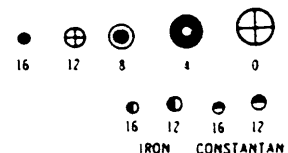

# 97 series

## MS inserts – contact arrangements

### (front view pin inserts) (cont.)

Items highlighted by box are most popular and most readily available. For meaning of symbols below, see notes and code of wire sizes on following page.

#### 8 contacts

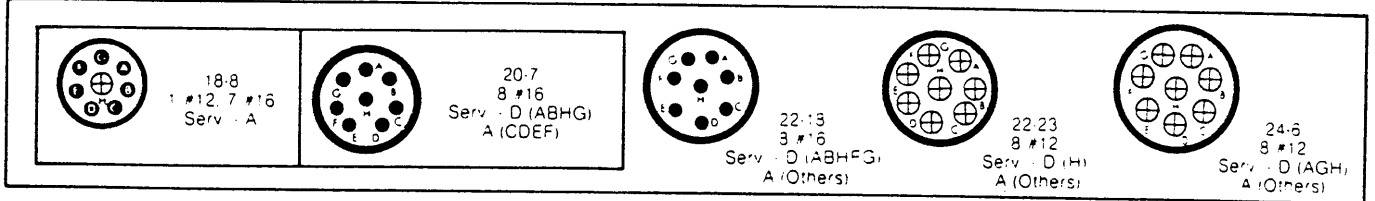

#### 9 contacts

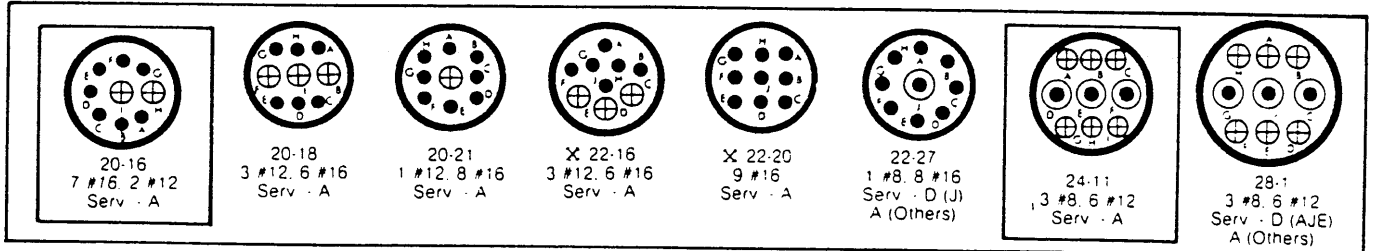

#### 10 contacts

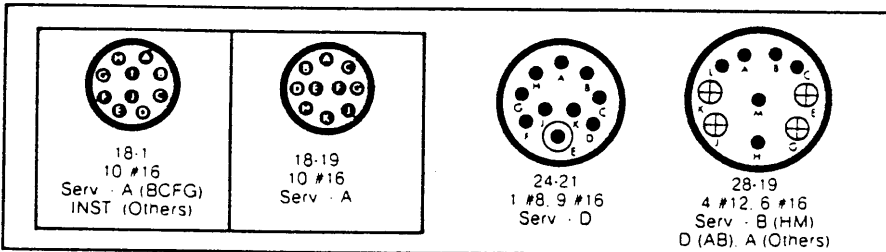

#### 11 contacts

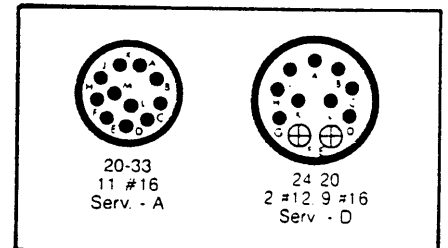

#### 12 contacts

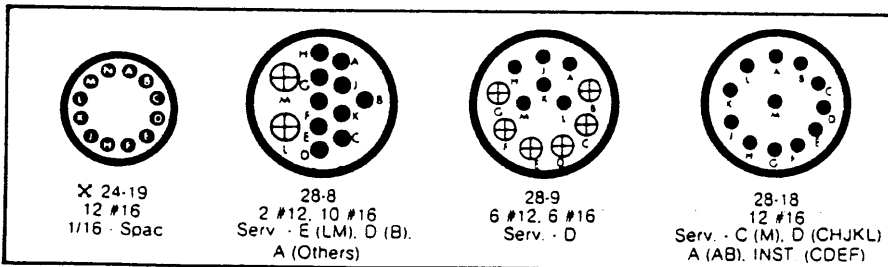

#### 13 contacts

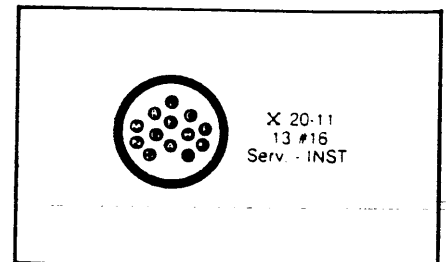

# 97 series MS inserts – contact arrangements (front view pin inserts) (cont.)

Items highlighted by box are most popular and most readily available. For meaning of symbols below, see notes and code of wire sizes on following page.

## 14 contacts

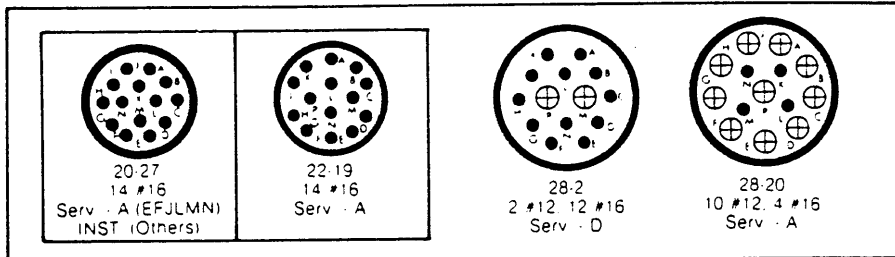

## 15 contacts

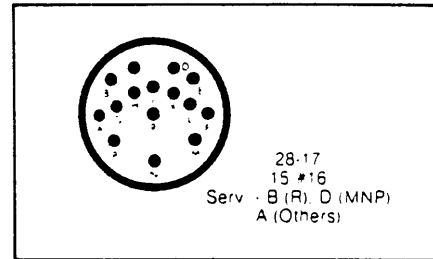

## 16 contacts

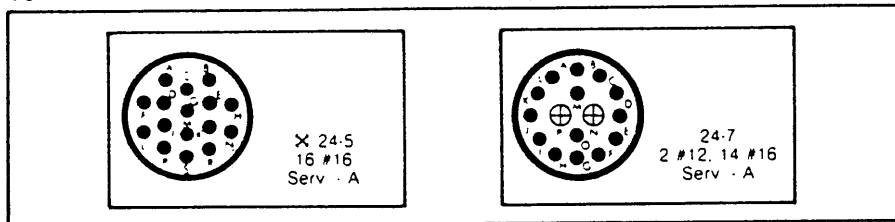

## 17 contacts

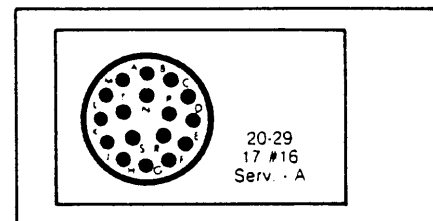

## 19 contacts

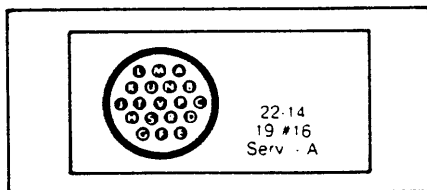

## 20 contacts

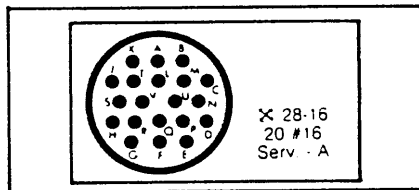

## 22 contacts

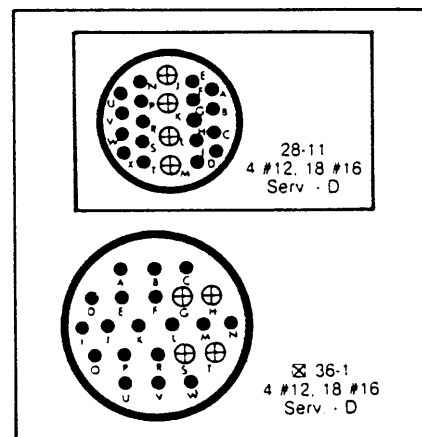

## 23 contacts

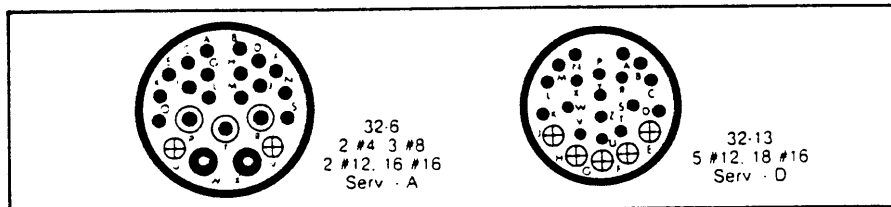

## 24 contacts

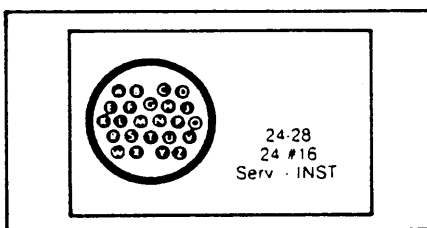

## 26 contacts

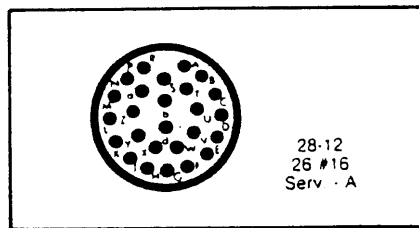

## 30 contacts

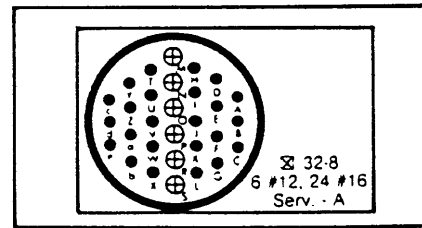

# 97 series MS inserts – contact arrangements (front view pin inserts) (cont.)

31 contacts

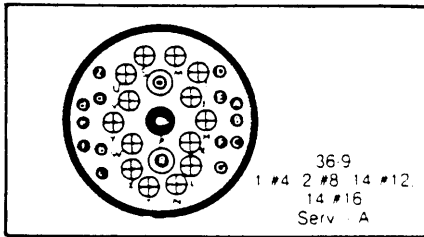

35 contacts

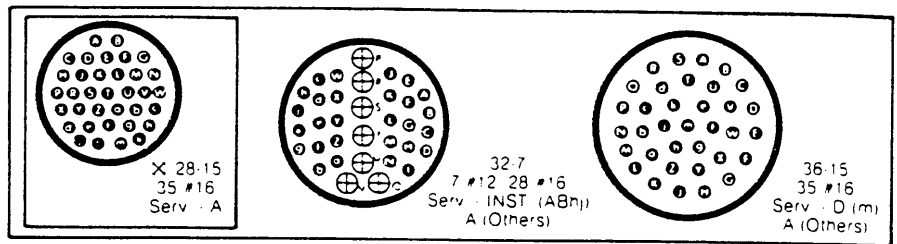

37 contacts

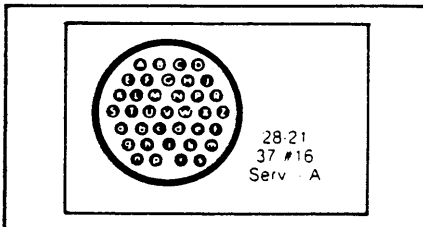

47 contacts

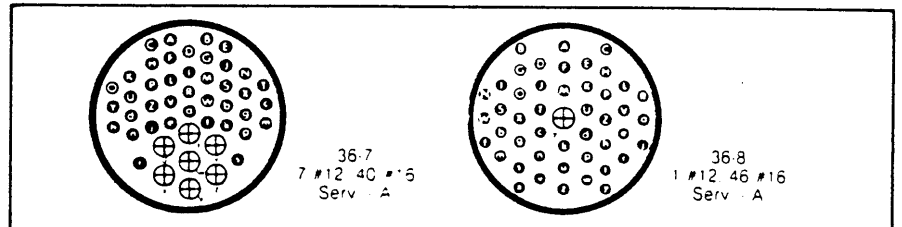

48 contacts

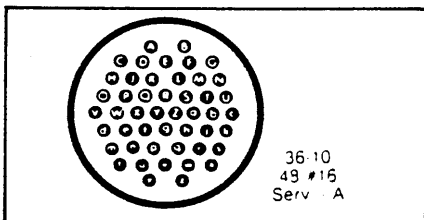

52 contacts

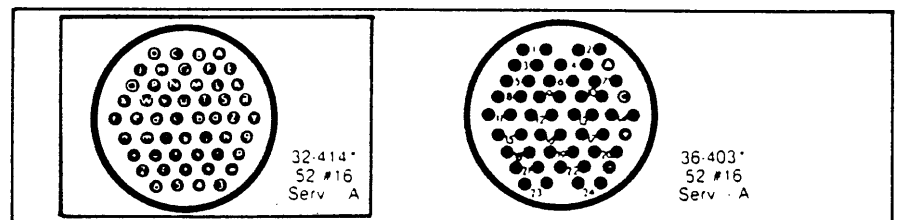

SERVICE		INST	A	D	E	B	C
Limiting Operating	DC	250	700	1250	1750	2450	4200
Voltages at sea level	AC (rms)	200	500	900	1250	1750	3000
See notes 1 and 2							
SERVICE CHART above shows Army-Navy ratings for aircraft use							
INST service normally for low voltages and currents							
Effective Creepage (nominal)	Inch	1/16	1/8	3/16	1/4	5/16	1
	mm	1.57	3.18	4.75	6.35	7.92	25.40
Mechanical Spacing (nominal)	Inch	1/16	1/8	3/16	1/4	5/16	
	mm	1.57	3.18	4.75	6.35	7.92	

## TEST CURRENT

Contact Size	16	12	8	4	0
Amperes	13	23	46	80	150

NOTE 1 Transients were not considered in calculating these values

NOTE 2 Limiting operating voltages at 50,000 feet altitude are approximately 25% of the sea level values

## CODE OF WIRE SIZES

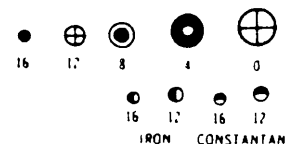

- ☒ Inactive for new military design but available for replacement or for non-military purposes.
- \* Consult Sidney, NY for availability
- \* "MS" number not assigned. Use "97" prefix in place of "MS" in completing catalog number.

†† High Voltage Contact. Rating 24,000 volts DC, 17,000 volts R.M.S., 60 cps at sea level - 41 amps.  
Maximum - in mated condition with connector potted.



# 97 series alternate insert positions

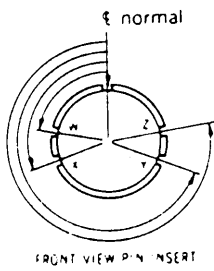

DEGREES					DEGREES				
Insert	W	X	Y	Z	Insert	W	X	Y	Z
12S-3	70	145	215	290	22-14	80	110	250	280
14S-2	—	120	240	—	22-15	80	110	250	280
14S-5	—	110	—	—	22-16	80	110	250	280
14S-7	90	180	270	—	22-18	80	110	250	280
14S-9	70	145	215	290	22-19	80	110	250	280
16S-1	80	—	—	280	22-20	35	110	250	325
16S-4	35	110	250	325	22-22	—	110	250	—
16S-5	70	145	215	290	22-23	35	—	250	—
16S-6	90	180	270	—	22-27	80	—	250	280
16-7	80	110	250	280	22-28	80	—	—	280
16S-8	—	170	265	—	22-34	80	110	250	280
16-9	35	110	250	325	24-2	80	—	—	280
16-10	90	180	270	—	24-5	80	110	250	280
16-11	35	110	250	325	24-6	80	110	250	280
16-13	35	110	250	325	24-7	80	110	250	280
18-1	70	145	215	290	24-9	35	110	250	325
18-3	35	110	250	325	24-10	80	—	—	280
18-4	35	110	250	325	24-11	35	110	250	325
18-5	80	110	250	280	24-12	80	110	250	280
18-8	70	—	—	290	24-16	80	110	250	280
18-9	80	110	250	280	24-20	80	110	250	280
18-10	—	120	240	—	24-21	80	110	250	280
18-11	—	170	265	—	24-22	45	110	250	—
18-12	80	—	—	280	24-27	80	—	—	280
18-13	80	110	250	280	24-28	80	110	250	280
18-19	—	120	240	—	28-1	80	110	250	280
18-20	90	180	270	—	28-2	35	110	250	325
18-22	70	145	215	290	28-3	70	145	215	290
18-29	90	180	270	—	28-5	35	110	250	325
20-3	70	145	215	290	28-6	70	145	215	290
20-4	45	110	250	—	28-8	80	110	250	280
20-6	70	145	215	290	28-9	80	110	250	280
20-7	80	110	250	280	28-10	80	110	250	280
20-8	80	110	250	280	28-11	80	110	250	280
20-14	80	110	250	280	28-12	90	180	270	—
20-15	80	—	—	280	28-15	80	110	250	280
20-16	80	110	250	280	28-16	80	110	250	280
20-17	90	180	270	—	28-17	80	110	250	280
20-18	35	110	250	325	28-18	70	145	215	290
20-19	90	180	270	—	28-19	80	110	250	280
20-21	35	110	250	325	28-20	80	110	250	280
20-22	80	110	250	280	28-21	80	110	250	280
20-23	35	110	250	325	32-5	35	110	250	325
20-24	35	110	250	325	32-6	80	110	250	280
20-27	35	110	250	325	32-7	80	125	235	280
20-29	80	—	—	280	32-8	80	125	235	280
22-1	35	110	250	325	32-13	80	110	250	280
22-2	70	145	215	290	32-17	45	110	250	—
22-4	35	110	250	325	32-414*	80*	110*	250*	280*
22-5	35	110	250	325	36-1	80	110	250	280
22-8	35	110	250	325	36-5	—	120	240	—
22-9	70	145	215	290	36-6	35	110	250	325
22-10	35	110	250	325	36-7	80	110	250	280
22-11	35	110	250	325	36-8	80	110	250	280
22-12	80	110	250	280	36-9	80	125	235	280
22-13	35	110	250	325	36-10	80	125	235	280
					36-15	60	125	245	305

\*Rotates opposite above illustration.

# 97 series insert specifications (8S-1 – 20-15)

Insert Number	Total Contacts	Mech'l. Spacing	Serv. Rating	Contact Size				
				#0	#4	#8	#12	#16
#8S-1	1	1/16 (1.57)	A					
#†10S-2	1	1/16 (1.57)	A					
10SL-3	3	1/16 (1.57)	A					3
10SL-4	2	1/16 (1.57)	A					2
*†12SL-844	4	1/16 (1.57)	A					4
12S-3	2	1/16 (1.57)	A					2
#12-5	1	1/8 (3.18)	D				1	
*†12S-6	2	1/16 (1.57)		THERMOCOUPLE				2
†14S-1	3	1/16 (1.57)	A					3
14S-2	4		INST					4
#†14S-4	1	1/8 (3.18)	D					
14S-5	5		INST					5
14S-6	6		INST					6
14S-7	3	1/16 (1.57)	A					3
†14S-9	2	1/16 (1.57)	A					2
16S-1	7	1/16 (1.57)	A					7
#16S-4	2	1/8 (3.18)	D					2
16S-5	3	1/16 (1.57)	A					3
#†16S-6	3	1/16 (1.57)	A					3
16-7	3	1/16 (1.57)	A			1		2
16S-8	5	1/16 (1.57)	A					5
16-9	4	1/16 (1.57)	A				2	2
16-10	3	1/16 (1.57)	A				3	
#†16-11	2	1/16 (1.57)	A				2	
16-12	1	1/16 (1.57)	A		1			
16-13	2	1/16 (1.57)	A	THERMO			2	
18-1	10	1/16 (1.57)	A					4
			INST					6
#†18-3	2	1/8 (3.18)	D				2	
18-4	4	1/8 (3.18)	D					4
#18-5	3	1/8 (3.18)	D				2	
18-8	8	1/16 (1.57)	A				1	7
#18-9	7		INST				2	5
†18-10	4	1/16 (1.57)	A				4	
18-11	5	1/16 (1.57)	A				5	
†18-12	6	1/16 (1.57)	A					6
18-13	4	1/16 (1.57)	A			1	3	
18-16	1	5/16 (7.92)	C				1	
†18-19	10	1/16 (1.57)	A					10
†18-20	5	1/16 (1.57)	A					5
†18-22	3	1/8 (3.18)	D					3
#†18-29	5	1/16 (1.57)	A					5
*18-420	1			HIGH VOLT CON				
†20-3	3	1/8 (3.18)	D				3	
20-4	4	1/8 (3.18)	D				4	
†20-6	3	1/8 (3.18)	D					3
20-7	8	1/8 (3.18)	D					4
		1/16 (1.57)	A					4
20-8	6		INST		2			4
†20-11	13		INST					13
20-14	5	1/16 (1.57)	A			2	3	
20-15	7	1/16 (1.57)	A				7	

†Inactive for new military design but available for replacement or for non-military purposes.  
 \*\*MS" number not assigned. Use "97" prefix in place of "MS" in completing catalog number.  
 \*\*Consult Sidney, NY for availability  
 #Molded-in-pin (MIP) insert requires (910) deviation.

# 97 series insert specifications (20-16 – 24-20)

Insert Number	Total Contacts	Mech'l. Spacing	Serv. Rating	Contact Size				
				#0	#4	#8	#12	#16
20-16	9	1/16 (1.57)	A				2	-
20-17	6	1/16 (1.57)	A				5	-
20-18	9	1/16 (1.57)	A				3	-
†20-19	3	1/16 (1.57)	A			3		
20-21	9	1/16 (1.57)	A				1	-
20-22	6	1/16 (1.57)	A			3		-
20-23	2	1/16 (1.57)	A			2		
20-24	4	1/16 (1.57)	A			2		-
20-27	14	1/16 (1.57)	A					-
20-29	17	1/16 (1.57)	A					-
20-33	11	1/16 (1.57)	A					-
†22-1	2	1/8 (3.18)	D			2		
22-2	3	1/8 (3.18)	D			3		
†22-4	4	1/16 (1.57)	A			2	2	
22-5	6	1/8 (3.18)	D				2	-
†22-8	2	3/16 (4.75)	E				2	
22-9	3	3/16 (4.75)	E				3	
22-10	4	3/16 (4.75)	E					-
22-11	2	1/4 (6.35)	B					2
22-12	5	1/8 (3.18)	D			2		-
†22-13	5	1/8 (3.18)	D					-
		1/16 (1.57)	A				4	
22-14	19	1/16 (1.57)	A					-
22-15	6	3/16 (4.75)	E					-
		1/16 (1.57)	A				5	
†22-16	9	1/16 (1.57)	A				3	-
22-18	8	1/8 (3.18)	D					-
		1/16 (1.57)	A					-
22-19	14	1/16 (1.57)	A					-
†22-20	9	1/16 (1.57)	A					-
22-22	4	1/16 (1.57)	A			4		
22-23	8	1/8 (3.18)	D				1	
		1/16 (1.57)	A				7	
*22-26	7	1/8 (3.18)					2	5
22-27	9	1/8 (3.18)	D			1		
		1/16 (1.57)	A					3
†22-28	7	1/16 (1.57)	A				7	
22-34	5	1/8 (3.18)	D				3	2
24-2	7	1/8 (3.18)	D				7	
†24-5	16	1/16 (1.57)	A					16
24-6	8	1/8 (3.18)	D				3	
		1/16 (1.57)	A				5	
24-7	16	1/16 (1.57)	A				2	14
†24-9	2	1/16 (1.57)	A		2			
24-10	7	1/16 (1.57)	A			7		
24-11	9	1/16 (1.57)	A			3	6	
24-12	5	1/16 (1.57)	A		2		3	
24-16	7	1/8 (3.18)	D			1		3
		1/16 (1.57)	A				3	
†24-19	12	1/16 (1.57)						12
#24-20	11	1/8 (3.18)	D				2	9

†Inactive for new military design but available for replacement or for non-military purposes.  
 \*\*MS" number not assigned. Use "97" prefix in place of "MS" in completing catalog number.  
 \*\*Consult Sidney, NY for availability  
 #Molded-in-pin.(MIP) insert requires (910) deviation.

# 97 series insert specifications (24-21 – 40-60)

Insert Number	Total Contacts	Mech'l. Spacing	Serv. Rating	Contact Size				
				#0	#4	#8	#12	#16
24-21	10	1/8 (3.18)	D			1		9
*24-22	4	1/8 (3.18)	D			4		
24-27	7	3/16 (4.75)	E					7
24-28	24	1/16 (1.57)	INST					24
28-1	9	1/8 (3.18)	D			1	2	
		1/16 (1.57)	A			2	4	
28-2	14	1/8 (3.18)	D				2	12
28-3	3	3/16 (4.75)	E			3		
28-5	5	1/8 (3.18)	D		2		1	2
†28-6	3	1/8 (3.18)	D		3			
28-8	12	1/16 (1.57)	A					9
		1/8 (3.18)	D					1
		3/16 (4.75)	E				2	
28-9	12	1/8 (3.18)	D				6	6
28-10	7	1/8 (3.18)	D				1	
		1/16 (1.57)	A		2	2	2	
28-11	22	1/16 (1.57)	A				4	18
28-12	26	1/16 (1.57)	A					26
†28-15	35	1/16 (1.57)	A					35
†28-16	20	1/16 (1.57)	A					20
28-17	15	1/4 (6.35)	B					1
		1/8 (3.18)	D					3
		1/16 (1.57)	A					11
28-18	12	5/16 (7.92)	C					1
		1/8 (3.18)	D					5
		1/16 (1.57)	A					2
			INST					4
28-19	10	1/4 (6.35)	B					2
		1/8 (3.18)	D					2
		1/16 (1.57)	A				4	2
28-20	14	1/16 (1.57)	A				10	4
28-21	37	1/16 (1.57)	A					37
†32-5	2	1/8 (3.18)	D	2				
32-6	23	1/16 (1.57)	A		2	3	2	16
32-7	35	1/16 (1.57)	A				7	24
			INST					4
†32-8	30	1/16 (1.57)	A				6	24
32-13	23	1/8 (3.18)	D				5	18
32-17	4	1/8 (3.18)	D		4			
32-414	52	1/16 (1.57)	A					52
†36-1	22	1/8 (3.18)	D				4	18
36-5	4	1/16 (1.57)	A	4				
36-6	6	1/16 (1.57)	A	2	4			
36-7	47	1/16 (1.57)	A				7	40
36-8	47	1/16 (1.57)	A				1	46
36-9	31	1/16 (1.57)	A		1	2	14	14
36-10	48	1/16 (1.57)	A					48
36-15	35	1/16 (1.57)	A					34
		1/8 (3.18)	D					1
*36-403	52	1/16 (1.57)	A					52
*40-60	6		A	6				

†Inactive for new military design but available for replacement or for non-military purposes.  
 \*\*MS" number not assigned. Use "97" prefix in place of "MS" in completing catalog number.  
 \*\*Consult Sidney, NY for availability  
 #Molded-in-pin (MIP) insert requires (910) deviation.

# 97 series availability and weight reference (8S-1 – 18-12)

Insert Number	Wall Receptacles MS3100	Cable Receptacles MS3101	Box Receptacles MS3102	Straight Plugs MS3106		Quick Disconnect Plugs MS3107		Angle Plugs MS3108		Total Con- tacts
	Solid Shell	Solid Shell	Solid Shell	Solid Shell	Split Shell	Solid Shell	Split Shell	Solid Shell	Split Shell	
	A	A	A	A	B	A	B	A	B	
8S-1	.02	.01	.01	.02						1
†10S-2	.02	.02	.02	.02		.02		.04		1
10SL-3P	.03	.03	.02							2
10SL-3S				.03		.03		.06	.05	3
†10SL-4P	.02	.02	.02							2
†10SL-4S				.03		.03		.06	.05	2
12S-3	.04	.03	.03	.03		.03		.07	.07	2
12-5	.05	.04	.03	.06		.06		.09	.08	1
*12S-6	.04	.03	.03	.04		.04		.07	.08	2
*12SL-844P			.03							4
*12SL-844S				.05		.06		.08		4
†14S-1	.05	.04	.03	.06	.06	.06	.06	.08	.08	3
14S-2	.05	.04	.03	.06	.06	.06	.06	.08	.08	4
†14S-4	.05	.04	.03	.06	.06	.06	.06	.08	.08	1
14S-5	.05	.04	.04	.06	.06	.06	.06	.08	.08	5
14S-6	.05	.04	.04	.06	.06	.06	.06	.08	.08	6
14S-7	.05	.04	.03	.06	.06	.06	.06	.08	.08	3
†14S-9	.05	.04	.03	.06	.06	.07	.06	.08	.08	2
16S-1	.06	.05	.05	.07	.07	.08	.07	.14	.11	7
16S-4	.06	.05	.04	.07	.07	.07	.07	.12	.10	2
†16S-5	.06	.05	.04	.07	.07	.07	.07	.12	.10	3
†16S-6	.06	.05	.04	.07	.07	.09	.07	.12	.10	3
16-7	.08	.08	.07	.09		.07		.15	.14	3
16S-8	.06	.05	.04	.07	.07	.09	.07	.12	.10	5
16-9	.08	.07		.09		.09	.10	.12	.13	4
16-10	.08	.08	.07	.09		.09		.15	.14	3
†16-11	.08	.07	.07	.09		.11		.14	.13	2
16-12	.10	.09	.08	.11		.08		.16	.15	1
16-13	.07	.07	.06	.08		.11		.14	.13	2
18-1	.10	.10	.08	.11	.13	.12	.13	.16	.15	10
†18-3	.10	.10	.08	.12	.13	.11	.13	.16	.15	2
18-4	.09	.09	.07	.11	.13	.12	.13	.16	.15	4
18-5	.10	.10	.08	.12	.13	.13	.13	.16	.15	3
18-8	.10	.10	.08	.12	.14	.12	.14	.16	.15	8
18-9	.11	.10	.09	.12	.14	.13	.14	.17	.16	7
†18-10	.11		.09	.13	.14	.13	.14	.17	.16	4
18-11	.11	.11	.09	.13	.15	.11	.15	.18	.17	5
†18-12	.10	.09	.08	.11	.13	.13	.13	.16	.15	6

Where no weight is shown, insert is not available in that shell type.

†Inactive for new military design but available for replacement or for non-military purposes.  
 \*\*\*MS" number not assigned. Use "97" prefix in place of "MS" in completing catalog number.  
 \*\*Consult Sidney, NY for availability



Weights are for connectors with socket contacts. Connectors with pin contacts weigh slightly less.  
 If a weight appears in the column the shell is available.

Weight is shown in lbs.

# 97 series availability and weight reference (18-13 – 22-14)

Insert Number	Wall Receptacles MS3100	Cable Receptacles MS3101	Box Receptacles MS3102	Straight Plugs MS3106		Quick Disconnect Plugs MS3107		Angle Plugs MS3108		Total Con- tacts
	Solid Shell	Solid Shell	Solid Shell	Solid Shell	Split Shell	Solid Shell	Split Shell	Solid Shell	Split Shell	
	A	A	A	A	B	A	B	A	B	
18-13	.12	.12	.10	.13	.15	.13	.15	.18	.17	4
18-16	.09	.09	.07	.11	.13	.11	.13	.15	.14	1
†18-19	.10	.10	.08	.11	.13	.11	.13	.16	.15	10
†18-20	.09	.09	.07	.11	.13	.11	.13	.15	.15	5
†18-22	.09	.09	.07	.11	.13		.13	.16	.15	3
†18-29	.10		.08	.11	.13	.11	.13	.16	.15	5
*†18-420	.10	.10	.08	.12	.13	.12	.13	.16	.16	1
†20-3	.14	.13	.10	.15	.16	.15	.16	.24	.19	3
20-4	.14	.13	.10	.15	.16	.15	.16	.24	.19	4
†20-6	.12	.11	.09	.13	.15	.14	.15	.23	.18	3
20-7	.13	.12	.09	.14	.15	.14	.15	.23	.18	8
20-8	.15	.14	.12	.16	.18	.16	.18	.26	.20	6
†20-11	.14	.13	.11	.15	.17	.15	.17	.25	.20	13
20-14	.16	.15	.13	.17	.19	.17	.19	.27	.21	5
20-15	.15	.14	.12	.16	.18	.16	.18	.26	.21	7
20-16	.14	.13	.10	.15	.16	.15	.16	.24	.19	9
20-17	.15	.14	.11	.16	.17	.16	.17	.25	.20	6
20-18	.14	.13	.11	.15	.17	.15	.17	.25	.19	9
†20-19	.16	.15	.13	.17	.19	.17	.19	.27	.21	3
20-21	.13	.12	.10	.14	.16	.14	.16	.24	.19	9
20-22	.16	.15	.13	.17	.19	.17	.19	.27	.22	6
†20-23	.15	.14	.11	.16	.17	.16	.17	.25	.20	2
20-24	.15	.14	.11	.16	.17	.16	.17	.25	.20	4
20-27	.13	.12	.10	.14	.16	.14	.16	.24	.19	14
20-29	.14	.13	.11	.15	.17	.15	.17	.25	.20	17
20-33	.13	.12	.09	.14	.18	.18	.18	.23	.18	11
†22-1	.16	.16	.13	.18	.19	.18	.19	.27	.23	2
22-2	.17	.17	.14	.19	.20	.19	.20	.29	.24	3
†22-4	.21	.17	.14	.19	.20	.19	.20	.28	.23	4
22-5	.15	.14	.12	.17	.18	.17	.18	.26	.21	6
†22-8	.15	.14	.11	.16	.18	.16	.18	.26	.21	2
22-9	.15	.15	.12	.17	.18	.17	.18	.26	.21	3
22-10	.14	.13	.10	.15	.17	.15	.17	.25	.20	4
22-11	.14	.13	.10	.15	.17	.15	.17	.25	.20	2
22-12	.16	.16	.13	.18	.19	.18	.19	.27	.23	5
†22-13	.16	.15	.12	.17	.18	.17	.18	.27	.22	5
22-14	.15	.14	.11	.16	.18	.16	.18	.26	.21	19

Where no weight is shown, insert is not available in that shell type.

†Inactive for new military design but available for replacement or for non-military purposes.  
 \*\*MS" number not assigned. Use "97" prefix in place of "MS" in completing catalog number.  
 \*\*Consult Sidney, NY for availability

Weights are for connectors with socket contacts. Connectors with pin contacts weigh slightly less.  
 If a weight appears in the column the shell is available.

Weight is shown in lbs.

# 97 series availability and weight reference (22-15 — 28-15)

Insert Number	Wall Receptacles MS3100	Cable Receptacles MS3101	Box Receptacles MS3102	Straight Plugs MS3106		Quick Disconnect Plugs MS3107		Angle Plugs MS3108		Total Con- tacts
	Solid Shell	Solid Shell	Solid Shell	Solid Shell	Split Shell	Solid Shell	Split Shell	Solid Shell	Split Shell	
	A	A	A	A	B	A	B	A	B	
22-15	.16	.14	.13	.17	.19	.17	.19	.27	.22	6
†22-16	.16	.15	.12	.17	.18	.17	.18	.27	.22	9
22-18	.14	.13	.10	.15	.17	.15	.17	.25	.20	8
22-19	.15	.14	.11	.16	.18	.16	.18	.26	.21	14
†22-20	.14	.14	.11	.16	.17	.16	.17	.25	.21	9
22-22	.19	.19	.16	.21	.26	.21	.22	.30	.25	4
22-23	.17	.16	.13	.18	.20	.18	.20	.28	.23	8
†22-26	.15	.14	.11						.19	7
22-27	.15	.15	.12	.17	.18	.17	.18	.27	.22	9
†22-28	.17	.16	.13	.18	.20	.18	.20	.28	.23	7
†22-34	.15	.15	.12	.17	.18	.17	.18	.26	.22	5
24-2	.20	.19	.16	.22	.24	.22	.24	.39	.29	7
†24-5	.18	.17	.14	.20	.22	.20	.22	.37	.27	16
24-6	.20	.19	.16	.22	.24	.22	.27	.39	.29	8
24-7	.19	.18	.14	.21	.23	.21	.23	.38	.27	16
†24-9	.22	.21	.17	.24	.25	.24	.25	.41	.30	2
24-10	.26	.25	.21	.28	.30	.28	.30	.45	.34	7
24-11	.24	.22	.19	.26	.27	.26	.27	.43	.32	9
24-12	.23	.22	.19	.25	.27	.25	.27	.42	.32	5
24-16	.20	.19	.15	.22	.24	.22	.24	.39	.28	7
†24-19	.18	.17	.13	.20	.22			.37	.36	12
24-20	.19	.17	.14	.21	.22	.21	.22	.38	.27	11
24-21	.19	.17	.14	.21	.23	.21	.23	.38	.27	10
24-22	.22	.21	.18	.24	.26	.24	.26	.41	.30	4
24-27	.17	.16	.13	.20	.21	.20	.21	.36	.26	7
24-28	.19	.18	.14	.21	.22	.21	.22	.38	.27	24
28-1	.29	.27	.24	.30	.32	.30	.32	.44	.36	9
28-2	.24	.22	.19	.25	.27	.25	.27	.40	.32	14
28-3	.26	.24	.21	.28	.30	.28	.30	.42	.34	3
28-5	.28	.28	.23	.30	.32	.30	.32	.44	.36	5
†28-6	.30	.28	.25	.31	.33	.31	.33	.45	.38	3
28-8	.23	.22	.18	.25	.27	.25	.27	.39	.31	12
28-9	.25	.24	.20	.27	.29	.27	.29	.41	.33	12
28-10	.31	.29	.26	.33	.35	.33	.35	.47	.39	7
28-11	.25	.24	.20	.27	.29	.27	.29	.41	.33	22
28-12	.24	.22	.19	.26	.28	.26	.28	.40	.32	26
†28-15	.25	.23	.20	.26	.28	.26	.28	.40	.32	35

Where no weight is shown, insert is not available in that shell type.

†Inactive for new military design but available for replacement or for non-military purposes.  
 \*\*MS" number not assigned. Use "97" prefix in place of "MS" in completing catalog number.  
 \*\*Consult Sidney, NY for availability

Weights are for connectors with socket contacts. Connectors with pin contacts weigh slightly less.  
 If a weight appears in the column the shell is available.

Weight is shown in lbs.

# 97 series availability and weight reference (28-16 – 40-60)

Insert Number	Wall Receptacles MS3100	Cable Receptacles MS3101	Box Receptacles MS3102	Straight Plugs MS3106		Quick Disconnect Plugs MS3107		Angle Plugs MS3108		Total Con- tacts
	Solid Shell	Solid Shell	Solid Shell	Solid Shell	Split Shell	Solid Shell	Split Shell	Solid Shell	Split Shell	
	A	A	A	A	B	A	B	A	B	
†28-16	.24	.22	.19	.25	.27	.25	.27	.39	.31	20
28-17	.23	.22	.18	.25	.27	.25	.27	.39	.31	15
28-18	.23	.22	.18	.25	.27	.25	.27	.39	.31	12
28-19	.24	.22	.19	.26	.28	.26	.28	.40	.32	10
28-20	.27	.25	.22	.29	.31	.29	.31	.43	.35	14
28-21	.25	.23	.20	.26	.28	.26	.28	.40	.32	37
†32-5	.36	.35	.32	.38	.40				.48	2
32-6	.39	.38	.35	.41	.43				.51	23
32-7	.33	.33	.29	.36	.38				.45	35
†32-8	.32	.32	.29	.35	.37				.44	30
32-13	.32	.31	.28	.34	.36				.44	23
32-17	.37	.37	.34	.40	.42				.49	4
†32-414	.35	.35	.31	.38	.40				.48	52
†36-1	.41	.39	.34	.41	.43				.52	22
36-5	.54	.52	.47	.54	.56				.65	4
36-6	.55	.53	.49	.55	.57				.67	6
36-7	.44	.41	.37	.44	.45				.55	47
36-8	.40	.38	.34	.41	.42				.52	47
36-9	.50	.47	.43	.50	.51				.61	31
36-10	.41	.39	.34	.41	.43				.53	48
36-15	.40	.37	.38	.40	.41				.51	35
*†36-403	.40	.36	.33	.40	.41				.51	52
*†40-60	.72	.68	.64	.71					.85	6

Where no weight is shown, insert is not available in that shell type.

†Inactive for new military design but available for replacement or for non-military purposes.  
 \*\*MS" number not assigned. Use "97" prefix in place of "MS" in completing catalog number.  
 \*\*Consult Sidney, NY for availability

Weights are for connectors with socket contacts. Connectors with pin contacts weigh slightly less.  
 If a weight appears in the column the shell is available.

Weight is shown in lbs.



# 97 series MIL-C-5015 receptacle shell types

## MS-3100A receptacle

Solid shell construction is strong and conserves space. Includes integral polarizing key in front. Back shell is threaded for standard MS/AN fittings.

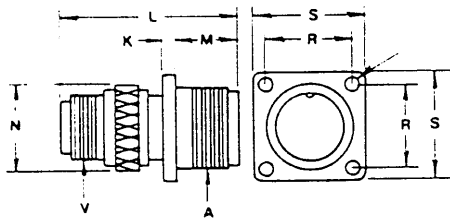

## MS-3101A cable receptacle

Solid shell construction is strong and conserves space. Includes integral polarizing key in front shell. Machined back shell is threaded for standard MS/AN fittings. Can be unscrewed for inspection or soldering.

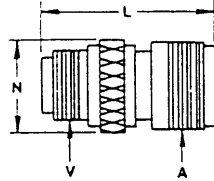

## MS-3102A box receptacle

Solid shell designed for open wiring. Mounts directly on chassis, equipment or panel. Includes internal polarized key in front shell.

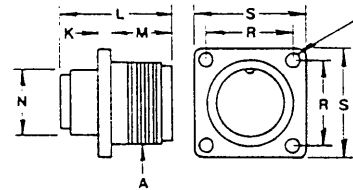

Mounting Holes  
173 (4.384) DIA  
FOR SIZES 32 AND 36  
147 (3.734) DIA  
FOR SIZES 24 AND 28  
120 (3.048) DIA  
FOR ALL OTHER SIZES

Panel Opening

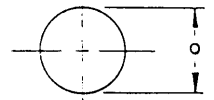

## MS3100A and MS3101A

Connector Size	A Coupling Threads	K Ref.		L Max.		M Ref.		N Ref.		O Ref.		R Ref.		S Ref.		V Fitting Threads
		Inch	mm	Inch	mm	Inch	mm	Inch	mm	Inch	mm	Inch	mm	Inch	mm	
8S	1/2-28	5/64	1.98	1-1/4	31.75	9/16	14.27	17/32	13.49	.562	14.27	19/32	15.06	7/8	22.23	1/2-28
10S	5/8-24	5/64	1.98	1-5/16	33.32	9/16	14.27	5/8	15.88	.688	17.48	23/32	18.24	1	25.40	1/2-28
10SL	5/8-24	5/64	1.98	1-9/32	32.53	9/16	14.27	3/4	19.05	.812	20.62	23/32	18.24	1	25.40	5/8-24
12S	3/4-20	5/64	1.98	1-15/32	37.29	9/16	14.27	25/32	19.84	.812	20.62	13/16	20.62	1-3/32	27.76	5/8-24
12	3/4-20	5/64	1.98	1-27/32	46.81	3/4	19.05	25/32	19.84	.812	20.62	13/16	20.62	1-3/32	27.76	5/8-24
14S	7/8-20	5/64	1.98	1-7/16	36.50	9/16	14.27	7/8	22.23	.938	23.83	29/32	23.01	1-3/16	30.15	3/4-20
14	7/8-20	5/64	1.98	1-27/32	46.81	3/4	19.05	7/8	22.23	.938	23.83	29/32	23.01	1-3/16	30.15	3/4-20
16S	1 -20	5/64	1.98	1-31/64	37.69	9/16	14.27	1	25.40	1.062	26.97	31/32	24.59	1-9/32	32.54	7/8-20
16	1 -20	1/8	3.18	1-57/64	48.01	3/4	19.05	1	25.40	1.062	26.97	31/32	24.59	1-9/32	32.54	7/8-20
18	1-1/8-18	1/8	3.18	2	50.80	3/4	19.05	1-1/8	28.58	1.188	30.18	1-1/16	26.97	1-3/8	34.93	1 -20
20	1-1/4-18	1/8	3.18	2-1/8	53.98	3/4	19.05	1-1/4	31.75	1.312	33.32	1-5/32	29.36	1-1/2	38.10	1-3/16-18
22	1-3/8-18	1/8	3.18	2-1/8	53.98	3/4	19.05	1-3/8	34.93	1.438	36.53	1-1/4	31.75	1-5/8	39.67	1-3/16-18
24	1-1/2-18	1/8	3.18	2-1/4	57.15	13/16	20.62	1-1/2	38.10	1.562	36.67	1-3/8	34.43	1-3/4	44.45	1-7/16-18
28	1-3/4-18	1/8	3.18	2-1/4	57.15	13/16	20.62	1-3/4	44.45	1.812	46.02	1-9/16	39.67	2	50.80	1-7/16-18
32	2 -18	1/8	3.18	2-3/8	60.33	7/8	22.23	2-1/32	51.59	2.062	52.37	1-3/4	44.45	2-1/4	57.15	1-3/4-18
36	2-1/4-16	1/8	3.18	2-3/8	60.33	7/8	22.23	2-1/4	57.15	2.312	58.72	1-15/16	49.20	2-1/2	63.50	2 -18
40	2-1/2-16	1/8	3.18	2-3/8	60.33	7/8	22.23	2-1/2	63.50	2.562	65.07	2-3/16	55.55	2-3/4	69.85	2-1/4-16

## MS3102A

Connector Size	A Coupling Threads	K Ref.		L Max.		M Ref.		N Ref.		O Ref.		R Ref.		S Ref.	
		Inch	mm	Inch	mm	Inch	mm	Inch	mm	Inch	mm	Inch	mm	Inch	mm
8S	1/2-28	5/64	1.98	27/32	21.41	9/16	14.27	7/16	11.10	.562	14.27	19/32	15.06	7/8	22.23
10S	5/8-24	5/64	1.98	27/32	21.41	9/16	14.27	1/2	12.70	.688	17.48	23/32	18.24	1	25.40
10SL	5/8-24	5/64	1.98	61/64	24.21	35/64	13.87	11/16	17.48	.812	20.62	23/32	18.24	1	25.40
12S	3/4-20	5/64	1.98	61/64	24.21	9/16	14.27	11/16	17.45	.812	20.62	13/16	20.62	1-3/32	27.76
12	3/4-20	5/64	1.98	1-5/16	33.32	3/4	19.05	11/16	17.45	.812	20.62	13/16	20.62	1-3/32	27.76
12SL	3/4-20	5/64	1.98	27/32	21.41	35/64	13.87	11/16	17.45	.938	23.83	13/16	20.62	1-3/32	27.76
14S	7/8-20	5/64	1.98	15/16	23.80	9/16	14.27	3/4	19.05	.938	23.83	29/32	23.01	1-3/16	30.15
14	7/8-20	5/64	1.98	1-5/16	33.32	3/4	19.05	3/4	19.05	.938	23.83	29/32	23.01	1-3/16	30.15
16S	1 -20	5/64	1.98	15/16	23.80	9/16	14.27	7/8	22.23	1.062	26.97	31/32	24.59	1-9/32	32.54
16	1 -20	1/8	3.18	1-11/32	34.11	3/4	19.05	7/8	22.23	1.062	26.97	31/32	24.59	1-9/32	32.54
18	1-1/8-18	1/8	3.18	1-11/32	34.11	3/4	19.05	1	25.40	1.188	30.18	1-1/16	26.97	1-3/8	34.93
20	1-1/4-18	1/8	3.18	1-11/32	34.11	3/4	19.05	1-1/8	28.58	1.312	33.32	1-5/32	29.36	1-1/2	38.10
22	1-3/8-18	1/8	3.18	1-11/32	34.11	3/4	19.05	1-1/4	31.75	1.438	36.53	1-1/4	31.75	1-5/8	41.28
24	1-1/2-18	1/8	3.18	1-11/32	34.11	13/16	20.62	1-3/8	34.93	1.562	39.67	1-3/8	34.93	1-3/4	44.45
28	1-3/4-18	1/8	3.18	1-11/32	34.11	13/16	20.62	1-5/8	41.28	1.812	46.02	1-9/16	39.67	2	50.80
32	2 -18	1/8	3.18	1-7/16	36.50	7/8	22.23	1-29/32	48.41	2.062	52.37	1-3/4	44.45	2-1/4	57.15
36	2-1/4-18	1/8	3.18	1-7/16	36.50	7/8	22.23	2-1/8	53.98	2.312	58.72	1-15/16	49.20	2-1/2	63.50
40	2-1/2-16	1/8	3.18	1-7/16	36.50	7/8	22.23	2-3/8	60.33	2.562	65.07	2-3/16	55.55	2-3/4	69.85

# 97 series MIL-C-5015 solid shell plug types

## MS3106A

Connector Size	L Max.		N Ref.		Q Max.		V	
	Inch	mm	Inch	mm	Inch	mm	Fitting Threads	
8S	1-1/4	31.75	17/32	13.49	3/4	19.05	1/2-28	
10S	1-5/16	33.32	5/8	15.88	7/8	22.23	1/2-28	
10SL	1-3/8	34.93	3/4	19.05	7/8	22.23	5/8-24	
12S	1-7/16	36.50	25/32	19.84	1	25.40	5/8-24	
12	1-7/8	47.63	25/32	19.84	1	25.40	5/8-24	
12SL	1-31/64	37.69	7/8	22.23	1	25.40	3/4-20	
14S	1-7/16	36.50	7/8	22.23	1-1/8	28.58	3/4-20	
14	1-7/8	47.63	7/8	22.23	1-1/8	28.58	3/4-20	
16S	1-29/64	36.91	1	25.40	1-1/4	31.75	7/8-20	
16	1-57/64	48.01	1	25.40	1-1/4	31.75	7/8-20	
18	2	50.80	1-1/8	28.57	1-11/32	34.11	1-20	
20	2-1/8	53.98	1-1/4	31.75	1-15/32	37.29	1-3/16-18	
22	2-1/8	53.98	1-3/8	34.93	1-19/32	40.46	1-3/16-18	
24	2-1/4	57.15	1-1/2	38.10	1-23/32	43.64	1-7/16-18	
28	2-1/4	57.15	1-3/4	44.45	1-31/32	49.99	1-7/16-18	
32	2-3/8	60.33	2-1/32	51.59	2-7/32	56.34	1-3/4-18	
36	2-3/8	60.33	2-1/4	57.15	2-15/32	62.69	2-18	
40	2-3/8	60.33	2-1/2	63.50	2-23/32	69.04	2-1/4-16	

### MS-3106A straight plug

Sturdy, simple to assemble. Coupling ring machined from solid aluminum bar stock for high tensile strength. Mates with all types of MS receptacles. Front shell includes polarizing keyway. Back shell is threaded for standard MS/AN fittings.

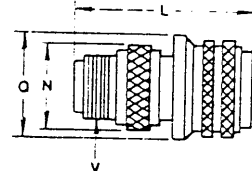

## MS3107A

Connector Size	L Max.		N Ref.		Q Max.		V	
	Inch	mm	Inch	mm	Inch	mm	Fitting Threads	
10S	1-5/16	33.32	5/8	15.88	7/8	22.23	1/2-28	
10SL	1-3/8	34.92	3/4	19.05	7/8	22.23	5/8-24	
12S	1-7/16	36.50	25/32	19.84	1	25.40	5/8-24	
12	1-7/8	47.63	25/32	19.84	1	25.40	5/8-24	
14S	1-7/16	36.50	7/8	22.23	1-1/8	28.58	3/4-20	
14	1-7/8	47.63	7/8	22.23	1-1/8	28.58	3/4-20	
16S	1-29/64	36.91	1	25.40	1-1/4	31.75	7/8-20	
16	1-57/64	48.01	1	25.40	1-1/4	31.75	7/8-20	
18	2	50.80	1-1/8	28.58	1-11/32	34.11	1-20	
20	2-1/8	53.98	1-1/4	31.75	1-15/32	37.29	1-3/16-18	
22	2-1/8	53.98	1-3/8	34.93	1-19/32	40.46	1-3/16-18	
24	2-1/4	57.15	1-1/2	38.10	1-23/32	43.64	1-7/16-18	
28	2-1/4	57.15	1-3/4	44.45	1-31/32	49.99	1-7/16-18	

### MS-3107A quick-disconnect plug

For fast connect/disconnect applications. Front shell has polarizing keyway. Mates with all types of MS receptacles. Back shell is threaded for standard MS/AN fittings.

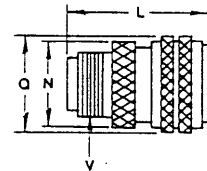

## MS3108A

Connector Size	L Ref.		Q Max.		U Ref.		V		Y Ref.	
	Inch	mm	Inch	mm	Inch	mm	Fitting Threads		Inch	mm
10S	1-1/4	31.75	7/8	22.23	7/8	22.23	1/2-28		25/32	19.84
10SL	1-5/16	33.32	7/8	22.23	1	25.40	5/8-24		1-1/16	26.97
12S	1-3/8	34.93	1	25.40	1	25.40	5/8-24		1-1/16	26.97
12SL	1-3/8	34.93	1	25.40	1	25.40	3/4-20		1-1/16	26.97
12	1-13/64	30.56	1	25.40	1	25.40	5/8-24		1-1/16	26.97
14S	1-3/8	34.93	1-1/8	28.58	1	25.40	3/4-20		1-1/16	26.97
14	1-13/16	46.02	1-1/8	28.58	1	25.40	3/4-20		1-1/16	26.97
16S	1-1/2	38.10	1-1/4	31.75	1-1/8	28.58	7/8-20		1-5/16	33.32
16	1-15/16	49.20	1-1/4	31.75	1-1/8	28.58	7/8-20		1-5/16	33.32
18	1-15/16	49.20	1-11/32	34.11	1-1/8	28.58	1-20		1-5/16	33.32
20	2-1/16	52.37	1-15/32	37.29	1-5/16	33.32	1-3/16-18		1-5/8	42.28
22	2-1/16	52.37	1-19/32	40.46	1-5/16	33.32	1-3/16-18		1-5/8	42.28
24	2-15/32	62.69	1-23/32	43.64	1-1/2	38.10	1-7/16-18		2	50.80
28	2-15/32	62.69	1-31/32	49.99	1-1/2	38.10	1-7/16-18		2	50.80

### MS-3108A angle plug

For use where space in front of panel or wall is at a premium. Swivel ring and plate combination allow cable take off at any angle relative to front shell polarizing key. Back shell is threaded for standard MS/AN fittings.

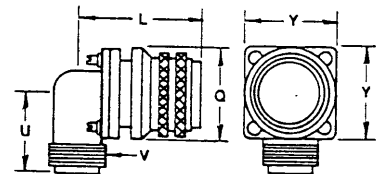

# 97 series MIL-C-5015 split shell plug types

## MS3106B

Connector Size	L Max.		Q Max.		V Fitting Threads	Y Ref.	
	Inch	mm	Inch	mm		Inch	mm
14S	1-11/16	42.85	1-1/8	28.58	3/4-20	1-5/32	29.36
16S	1-11/16	42.85	1-1/4	31.75	7/8-20	1-1/4	31.75
18	2-1/16	52.37	1-11/32	34.11	1-20	1-41/64	41.66
20	2-1/8	53.98	1-15/32	37.29	1-3/16-18	1-13/16	46.02
22	2-1/8	53.98	1-19/32	40.46	1-3/16-18	1-15/16	49.20
24	2-9/32	57.94	1-23/32	43.64	1-7/16-18	2-1/16	52.37
28	2-9/32	57.94	1-31/32	49.99	1-7/16-18	2-5/16	58.72
32	2-5/16	58.72	2-7/32	56.34	1-3/4-18	2-19/32	65.86
36	2-11/32	59.51	2-15/32	62.69	2-18	2-27/32	72.21
40	2-11/32	59.51	2-13/16	71.42	2-1/4-16	3-5/32	80.16

### MS-3106B straight plug

Used for unusual conduit applications where soldering and inspection is the prime requirement. Back shell is threaded for all standard MS/AN fittings.

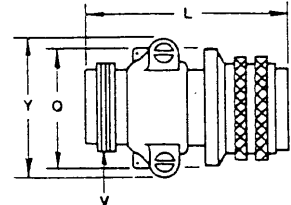

## MS3107B

Connector Size	L Max.		Q Max.		V Fitting Threads	Y Ref.	
	Inch	mm	Inch	mm		Inch	mm
14S	1-11/16	42.85	1-1/8	28.58	3/4-20	1-5/32	29.36
16S	1-11/16	42.85	1-1/4	31.75	7/8-20	1-1/4	31.75
18	2-1/16	52.37	1-11/32	34.11	1-20	1-41/64	41.66
20	2-1/8	53.99	1-15/32	37.29	1-3/16-18	1-13/16	46.02
22	2-1/8	53.99	1-19/32	40.46	1-3/16-18	1-15/16	49.20
24	2-9/32	57.94	1-23/32	43.64	1-7/16-18	2-1/16	52.37
28	2-9/32	57.94	1-31/32	49.99	1-7/16-18	2-5/16	58.72

### MS-3107B quick disconnect plug

For fast connect/disconnect applications. Front shell has polarizing keyway. Mates with all types of MS receptacles. Back shell is threaded for standard MS/AN fittings.

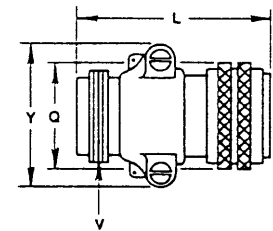

## MS3108B

Connector Size	L Ref.		Q Max.		U Ref.		V Fitting Threads	X Ref.	
	Inch	mm	Inch	mm	Inch	mm		Inch	mm
10S	1-3/8	34.93	7/8	22.23	7/8	22.23	1/2-28		
10SL	1-1/2	38.10	7/8	22.23	1	25.40	5/8-24		
12S	1-9/16	39.67	1	25.40	1	25.40	5/8-24	1/2	12.70
12	1-7/8	47.63	1	25.40	1	25.40	5/8-24	1/2	12.70
14S	1-23/32	43.64	1-1/8	28.58	1-1/16	26.97	3/4-20	21/32	16.66
14	1-15/16	49.20	1-1/8	28.58	1-1/16	26.97	3/4-20	21/32	16.66

### MS-3108B angle plug

Lightweight, roomy cavity, split longitudinally for convenient solder or inspection. Front shell is keyed to all the 90° angle housing to be rotated and locked at any 45° increment.

#### Size 10S-14

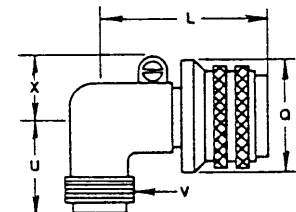

## MS3108B

Connector Size	L Ref.		Q Max.		U Ref.		V Fitting Threads	Y Ref.	
	Inch	mm	Inch	mm	Inch	mm		Inch	mm
16S	1-3/4	44.45	1-1/4	31.75	1-1/8	28.58	7/8-20	1-1/2	38.10
16	2-1/8	53.98	1-1/4	31.75	1-1/8	28.58	7/8-20	1-1/2	38.10
18	2-5/32	54.75	1-11/32	34.11	1-3/16	30.15	1-20	1-41/64	41.66
20	2-3/8	60.33	1-15/32	37.29	1-5/16	33.32	1-3/16-18	1-13/16	46.02
22	2-13/32	61.11	1-19/32	40.46	1-5/16	33.32	1-3/16-18	1-15/16	49.20
24	2-5/8	66.68	1-23/32	43.64	1-7/16	36.50	1-7/16-18	2-1/16	52.37
28	2-5/8	66.68	1-31/32	49.99	1-7/16	36.50	1-7/16-18	2-5/16	58.72
32	2-13/16	71.42	2-7/32	56.34	1-3/4	44.45	1-3/4-18	2-19/32	65.86
36	2-27/32	72.21	2-15/32	62.69	1-15/16	49.20	2-18	2-27/32	72.21
40	2-31/32	75.39	2-23/32	69.04	2-1/16	52.37	2-1/19/16	3-5/32	80.16

#### Size 16S-40

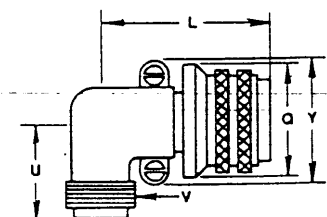

# 97 Series

## rear release

### crimp contact connectors

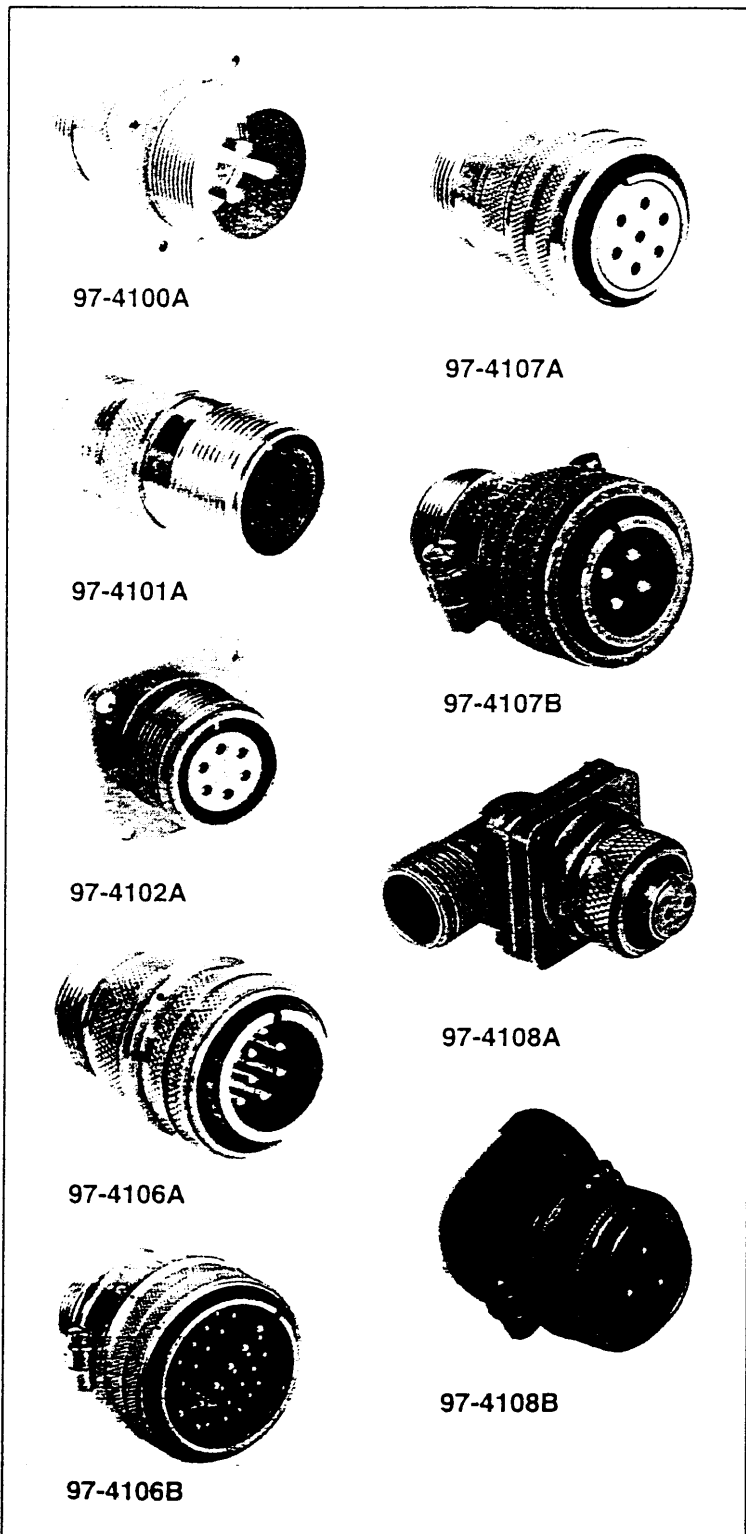

#### DESIGN FEATURES

- U/L and CSA recognized connector line
- Rugged metal shell
- Conductive finish
- Stamped & formed crimp contacts
- Closed entry socket contacts
- Plastic retention
- Utilizes standard 97 Series MIL-C-5015 hardware
- Intermateable and intermountable with existing 97 Series and MIL-C-5015 connectors
- Underwriters Laboratories approved recognition File E115497
- Canadian Standards Association Certification File LR69183

#### BENEFITS

- Positive self centering of contacts. Pins bent up to 20° will pick up
- Reduce user cost due to high speed termination
- Less equipment down time due to fatigue failure at wire contact junction or handling damage
- Greater contact to contact insulation, lighter weight, higher reliability
- No costly re-design or rework necessary on existing equipment
- Complete flexibility through multi-source product availability
- Adaptability to handle circuitry with EMI/EMP shielding requirements

The Amphenol 97-410X connector design incorporates Poke Home® Rear Release contacts. The 97 Series Rear Release line is intermateable and intermountable with existing 97 Series and MIL-C-5015 type shell styles in both plugs and receptacles. The connectors utilize 97 Series bright cadmium plated shells and standard insert configurations.

The connector is designed to be used with stamped and formed type crimp contacts. Contact design (size 16 only) incorporates insulation crimp support for greater strength at wire termination end. Contacts are available on reel assemblies for use with the high speed Amphenol Stripper Crimper capable of crimping 1500 contacts per hour. Hand crimp tools and bulk packaged contacts are also available for prototype, small production and field service.

Standard hardware available for the 97 Series connector can be used with the 97 Series crimp contact rear release line. Accessories should be ordered with the (639) plating deviation to match the bright cadmium connector finish.

# 97 series (crimp) specifications, insert arrangements

## Specifications

Standard shell finish - clear chromate over cadmium plate (optional plating available, see page 24).

Inserts - molded of a 94V-O Underwriters Laboratory rated material.

Contacts - copper alloy formed, silver plated (gold plating also available, see page 24).

Wire sizes - 12 AWG through 30 AWG.

All constructions perform satisfactorily from -55°C to -125°C (-67°F to +257°F).

## CURRENT RATINGS

Wire Size	12	14	16	18	20	22	26	28	30
Amperes	23	17	13	10	7.5	5	2	1.5	1.0

NOTE: Design specifications subject to change.

Consult Sidney, NY for the latest specifications and UL and CSA recognition.

## SERVICE RATING

Service Rating	Recommended Operating Voltage* at Sea Level	
	DC	AC (RMS)
Inst.	250	200
A	700	500
D	1250	900

\*The values listed represent operating values which include a generous safety factor.

## Insert Arrangements

Insert Arrangement	10SL-3	10SL-4	12S-3	14S-1	14S-2	14S-5	14S-7	16S-1	16S-8
Service Rating	A	A	A	A	Inst.	Inst.	A	A	A
Number of Contacts	3	2	2	3	4	5	3	7	5
Contact Size	16	16	16	16	16	16	16	16	16

Insert Arrangement	18-1	18-4	18-11	18-12	18-19	18-20	20-4
Service Rating	A(BCFG) Inst. (others)	D	A	A	A	A	D
Number of Contacts	10	4	5	6	10	5	4
Contact Size	16	16	12	16	16	16	12

Insert Arrangement	20-7	20-27	22-14	24-2	28-9	28-11
Service Rating	D(ABHG) A(CDEF)	A(EFJLMN) Inst. (others)	A	D	D	D
Number of Contacts	8	14	19	7	6 6	4 18
Contact Size	16	16	16	12	12 16	12 16

Insert Arrangement	28-12	28-20	28-21	32-8	32-414	36-10
Service Rating	A	A	A	A	A	A
Number of Contacts	26	10 4	37	6 24	52	48
Contact Size	16	12 16	16	12 16	16	16

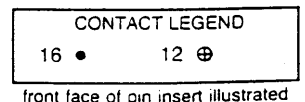

# shell dimensions

97-4100A

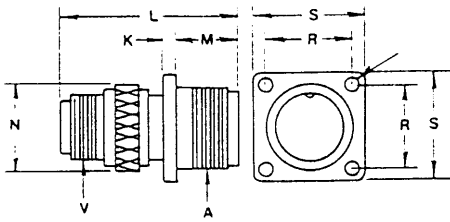

97-4101A

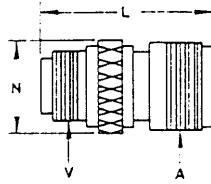

97-4102A

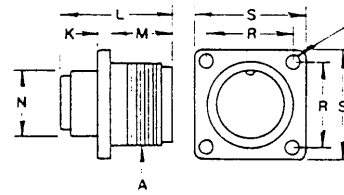

Mounting Holes  
 10 3/4 3/4 DIA  
 FOR SIZES 32 AND 36  
 1 7/8 3/4 DIA  
 FOR SIZES 24 and 28  
 2 3/4 3/4 DIA  
 FOR ALL OTHER SIZES

Panel Opening

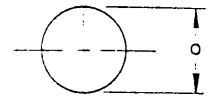

97-4100A/97-4101A

Shell Size	A Coupling Threads	K		L		M		N		O		R		S		V Fittings Threads
		Inches +.020 - .005	MM +.508 - .127	Inches Max.	MM Max.	Inches +.031 - .000	MM +0.787 - .0	Inches Max.	MM Max.	Inches .016	MM 0.406	Inches .005	MM 0.127	Inches +.031	MM +0.787	
10SL	5/8-24	.083	2.23	1.531	38.88	.562	14.27	.770	19.55	.812	20.62	.719	18.26	1.000	25.40	1 1/16-24
12S	3/4-20	.083	2.23	1.688	42.87	.562	14.27	.800	20.32	.812	20.62	.812	20.62	1.094	27.78	3/4-24
14S	7/8-20	.083	2.23	1.688	42.87	.562	14.27	.895	22.73	.938	23.82	.906	23.01	1.168	29.66	3/4-20
16S	1-20	.083	2.23	1.688	42.87	.562	14.27	1.020	25.90	1.062	26.97	.969	24.61	1.281	32.53	3/8-20
18	1 1/8-18	.125	3.175	2.062	52.37	.750	19.050	1.145	29.083	1.188	30.175	1.062	26.974	1.375	34.925	1-20
20	1 1/4-18	.125	3.175	2.188	55.57	.750	19.050	1.270	32.258	1.312	33.324	1.156	29.362	1.500	38.100	1 1/16-18
22	1 3/8-18	.125	3.175	2.188	55.57	.750	19.050	1.397	35.483	1.438	36.525	1.250	31.750	1.625	41.275	1 1/16-18
24	1 1/2-18	.125	3.175	2.312	58.72	.812	20.624	1.520	38.608	1.562	39.674	1.375	34.925	1.750	44.450	1 1/16-18
28	1 3/4-18	.125	3.175	2.312	58.72	.812	20.624	1.770	44.958	1.812	46.024	1.562	39.674	2.000	50.800	1 1/16-18
32	2-18	.130	3.302	2.438	61.92	.875	22.225	2.035	51.689	2.062	52.374	1.750	44.450	2.250	57.150	1 3/4-18
36	2 1/4-16	.130	3.302	2.438	61.92	.875	22.225	2.250	57.15	2.312	58.72	1.937	49.20	2.500	63.50	2-18

97-4102A

Shell Size	A Coupling Threads	K		L		M		N		O		R		S	
		Inches +.020 - .005	MM +.508 - .127	Inches Max.	MM Max.	Inches +.031 - .000	MM +0.787 - .0	Inches Max.	MM Max.	Inches .016	MM 0.406	Inches .005	MM 0.127	Inches +.031	MM +0.787
10SL	5/8-24	.083	2.23	1.305	33.14	.562	14.27	.697	17.70	.812	20.62	.719	18.26	1.000	25.40
12S	3/4-20	.083	2.23	1.305	33.14	.562	14.27	.697	17.70	.812	20.62	.812	20.62	1.094	27.78
14S	7/8-20	.083	2.23	1.305	33.14	.562	14.27	.765	19.43	.938	23.82	.906	23.01	1.168	29.66
16S	1-20	.083	2.23	1.305	33.14	.562	14.27	.890	22.50	1.062	26.97	.969	24.61	1.281	32.53
18	1 1/8-18	.125	3.175	1.531	38.887	.750	19.050	1.005	25.527	1.188	30.175	1.062	26.974	1.375	34.925
20	1 1/4-18	.125	3.175	1.531	38.887	.750	19.050	1.130	28.702	1.312	33.324	1.156	29.362	1.500	38.100
22	1 3/8-18	.125	3.175	1.531	38.887	.750	19.050	1.255	31.877	1.438	36.525	1.250	31.750	1.625	41.275
24	1 1/2-18	.125	3.175	1.531	38.887	.812	20.624	1.380	35.052	1.562	39.674	1.375	34.925	1.750	44.450
28	1 3/4-18	.125	3.175	1.531	38.887	.812	20.624	1.630	41.402	1.812	46.024	1.562	39.674	2.000	50.800
32	2-18	.130	3.302	1.531	38.887	.875	22.225	1.910	48.514	2.062	52.374	1.750	44.450	2.250	57.150
36	2 1/4-16	.130	3.302	1.531	38.887	.875	22.225	2.135	54.229	2.312	58.720	1.937	49.200	2.500	63.500

97-4106A/97-4107A

97-4106A

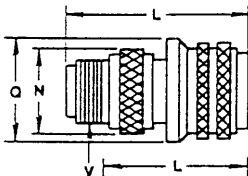

97-4107A

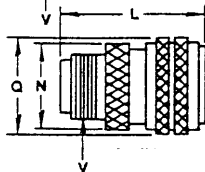

Shell Size	L		N		Q		V Fitting Threads
	Inches Max.	MM Max.	Inches Max.	MM Max.	Inches Max.	MM Max.	
10SL	1.531	38.88	.770	19.55	.969	24.61	5/8-24
12S	1.688	42.87	.800	20.32	1.062	26.97	5/8-24
14S	1.688	42.87	.895	22.73	1.156	29.36	3/4-20
16S	1.688	42.87	1.020	25.90	1.250	31.75	7/8-20
18	2.062	52.370	1.145	29.083	1.344	34.137	1-20
20	2.188	55.575	1.270	32.258	1.469	37.312	1 1/16-18
22	2.188	55.575	1.397	35.483	1.594	40.487	1 3/16-18
24	2.312	58.720	1.520	38.608	1.719	43.662	1 7/16-18
28	2.312	58.720	1.770	44.958	1.969	50.012	1 7/16-18
32	2.438	61.925	2.035	51.689	2.219	56.362	1 3/4-18
36	2.438	61.925	2.250	57.150	2.469	62.690	2-18

\*Available for 97-4106A only.

# shell dimensions (continued)

## 97-4108A

Shell Size	L		Q		U		V Fitting Threads	Y	
	Inch	MM	Inch	MM	Inch	MM		Inch	MM
10SL	1.312	33.32	.875	22.23	1.000	25.40	3/8-24	1.062	26.92
12S	1.375	34.93	1.000	25.40	1.000	25.40	3/8-24	1.062	26.92
14S	1.375	34.93	1.125	28.58	1.000	25.40	3/4-20	1.062	26.92
16S	1.500	38.10	1.250	31.75	1.125	28.58	7/8-20	1.312	33.32
18	1.9375	49.20	1.3438	34.11	1.250	28.58	1-20	1.3125	33.32
20	2.0625	52.37	1.4688	37.29	1.3125	33.32	1 1/16-18	1.6250	42.28
22	2.0625	52.37	1.5938	40.46	1.3215	33.32	1 1/16-18	1.6250	42.28
24	2.4688	62.69	1.7188	43.64	1.5000	38.10	1 7/16-18	2.0000	50.30
28	2.4688	62.69	1.9688	49.99	1.5000	38.10	1 7/16-18	2.0000	50.30

97-4108A angle plug

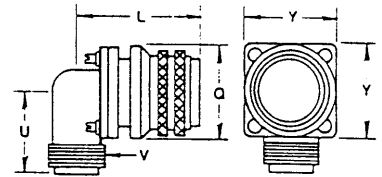

## 97-4106B

Shell Size	L		Q		V Fitting Threads	Y	
	Inch	MM	Inch	MM		Inch	MM
14S	1.687	42.85	1.125	28.58	3/4-20	1.156	29.36
16S	1.687	42.85	1.250	31.75	7/8-20	1.250	31.75
18	2.062	52.37	1.3438	34.11	1-20	1.6406	41.66
20	2.188	55.57	1.4688	37.29	1 1/16-18	1.8125	46.02
22	2.188	55.57	1.5938	40.46	1 1/16-18	1.9375	49.20
24	2.312	58.72	1.7188	43.64	1 7/16-18	2.0625	52.37
28	2.312	58.72	1.9688	49.99	1 7/16-18	2.3125	58.72
32	2.438	61.92	2.2188	56.34	1 3/4-18	2.5938	65.36
36	2.438	61.92	2.4688	62.69	2-18	2.8438	72.21

97-4106B straight plug

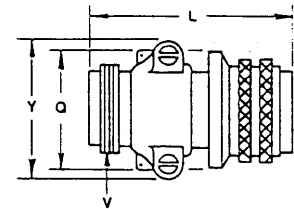

## 97-4107B

Shell Size	L		Q		V Fitting Threads	Y	
	Inch	MM	Inch	MM		Inch	MM
14S	1.687	42.85	1.125	28.58	3/4-20	1.156	29.36
16S	1.687	42.85	1.250	31.75	7/8-20	1.250	31.75
18	2.062	52.37	1.3438	34.11	1-20	1.6406	41.66
20	2.125	53.99	1.4688	37.29	1 3/16-18	1.8125	46.02
22	2.125	53.99	1.5938	40.46	1 3/16-18	1.9375	49.20
24	2.281	57.94	1.7188	43.64	1 7/16-18	2.0625	52.37
28	2.281	57.94	1.9688	49.99	1 7/16-18	2.3125	58.72

97-4107B straight plug

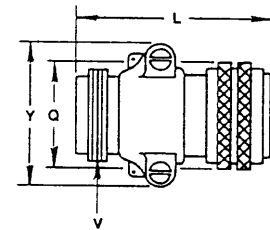

## 97-4108B

Shell Size	L		Q		U		V Fitting Threads	Y	
	Inch	MM	Inch	MM	Inch	MM		Inch	MM
10SL	1.500	38.10	.875	22.23	1.000	25.40	3/8-24	-	-
12S	1.562	39.67	1.000	25.40	1.000	25.40	3/8-24	.500	12.70
14S	1.718	43.64	1.125	28.58	1.062	26.97	3/4-20	.656	16.66
16S	1.750	44.45	1.250	31.75	1.125	28.58	7/8-20	1.500	38.10
18	2.1562	54.75	1.3438	34.11	1.1875	30.15	1-20	1.6406	41.66
20	2.3750	60.33	1.4688	37.29	1.3125	33.32	1 1/16-18	1.8125	46.02
22	2.4062	61.11	1.5938	40.46	1.3125	33.32	1 1/16-18	1.9375	49.20
24	2.6250	66.68	1.7188	43.64	1.4375	36.50	1 7/16-18	2.0625	52.37
28	2.6250	66.68	1.9688	49.99	1.4375	36.50	1 7/16-18	2.3125	58.72
32	2.8125	71.42	2.2188	56.34	1.7500	44.45	1 3/4-18	2.5938	65.86
36	2.8438	72.21	2.4688	62.69	1.9375	49.20	2-18	2.8438	72.21

97-4108B angle plug

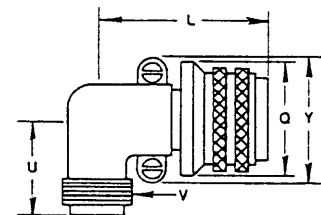

## accessories

Standard hardware available for 97 series connectors can be used with the 97 series crimp contact rear release line. Accessories should be ordered with the (639) plating deviation in order to match the connector plating, which is a bright cadmium finish.

# 97 series (crimp) how to order

## Connector Ordering Information

Example of Part Number

97 4101 A - 28-21 S Y (6XX)

**SERIES**

**SHELL TYPE**  
 4100 Wall Receptacle  
 4101 Cable Receptacle  
 4102 Box Receptacle  
 4106 Straight Plug  
 4107 Quick Disconnect Plug  
 4108 Angle Plug  
 Note: "4" Designates crimp contact rear release connector.

**SHELL CONSTRUCTION**  
 A - Solid Backshell  
 B - Split Backshell

**SHELL SIZE**  
 10SL, 12S, 14S, 16S, 18, 20, 24, 28, 32 & 36

**SHELL FINISH** Omit for standard finish (bright clear cadmium)  
 (662) Olive drab chromate over cadmium plate  
 (604) Anodized with dichromate seal

**ALTERNATE INSERT POSITIONS**  
 Omit for standard position. W, X, Y, or Z for alternate positions, depending on insert.

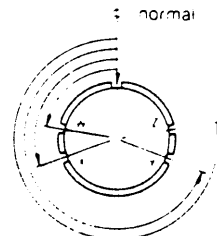

Insert	Degrees			
	W	X	Y	Z
12S-3	70	145	215	290
14S-2	-	120	240	-
14S-5	-	110	-	-
14S-7	90	180	270	-
16S-1	80	-	-	280
16S-8	-	170	265	-
18-1	70	145	215	290
18-4	35	110	250	325
18-11	-	170	265	-
18-12	80	-	-	280
18-19	-	120	240	-
18-20	90	180	270	-
20-4	45	110	250	-
20-7	80	110	250	280
20-27	35	110	250	325
22-14	80	-	-	280
24-2	80	-	-	280
28-9	80	110	250	280
28-11	80	110	250	280
28-12	90	180	270	-
28-20	80	110	250	280
28-21	80	110	250	280
32-8	80	125	235	280
32-414*	80*	110*	250*	280*
36-10	80	125	235	280

**TYPE OF CONTACT**  
 P - Pin  
 S - Socket

**INSERT DESIGNATION**  
 See insert arrangements page 2.

\*Rotates opposite above illustration.

Please note:  
 Contacts are not supplied with connector - see ordering information below.

## Contact Ordering Information

Reel Assembly (For use with semi-automatic crimping equipment; order number of reels required).

### REEL ASSEMBLIES AVAILABLE

Part Number	Size	For Connector Sizes
9738-1216P-X250	12	18 thru 36
9738-1216S-X250	12	18 thru 36
9745-1418P-X400	16	10SL thru 36
9745-1418S-X400	16	18 thru 36
9755-1418S-X400	16	10SL thru 16S only
9745-1622P-X400	16	10SL thru 36
9755-1622S-X400	16	10SL, 12S, 14S, 16S only
9745-1622S-X400	16	18 thru 36
9745-2026P-X400	16	10SL thru 36
9755-2026S-X400	16	10SL, 12S, 14S, 16S only
9745-2026S-X400	16	18 thru 36
9745-2630P-X400	16	10SL thru 36
9755-2630S-X400	16	10SL, 12S, 14S, 16S only
9745-2630S-X400	16	18 thru 36

Example of Part Number

97 38 1216 P X 250

**SERIES**

**CONTACT SIZE**  
 (38 = 12 size, 45, 55 = 16 size)

**WIRE SIZE ACCOMMODATED**  
 Example: 1216 will accommodate size 12 through 16 AWG wire.

**MATING END**  
 (P = Pin, S = Socket)

**QUANTITY PER REEL**  
 (250 = 2500, 400 = 4000)

**"X" INDICATES PLATING**  
 4- Silver Plate .0002 min. over Copper .00005 min.  
 5- Gold Plate .00003 min. over Nickel .00005 min.

### BULK PACKAGED CONTACTS AVAILABLE

Part Number	Size	For Connector Sizes
9738-1216P-X(920)	12	18 thru 36
9738-1216S-X(920)	12	18 thru 36
9745-1418P-X(920)	16	10SL thru 36
9745-1418S-X(920)	16	18 thru 36
9755-1418S-X(920)	16	10SL thru 16S only
9745-1622P-X(920)	16	10SL thru 36
9755-1622S-X(920)	16	10SL, 12S, 14S, 16S only
9745-1622S-X(920)	16	18 thru 36
9745-2026P-X(920)	16	10SL thru 36
9755-2026S-X(920)	16	10SL, 12S, 14S, 16S only
9745-2026S-X(920)	16	18 thru 36
9745-2630P-X(920)	16	10SL thru 36
9755-2630S-X(920)	16	10SL, 12S, 14S, 16S only
9745-2630S-X(920)	16	18 thru 36

Example of Part Number

97 38 1216 P X (920)

**SERIES**

**CONTACT SIZE**  
 (38 = 12 size, 45, 55 = 16 size)

**WIRE SIZE ACCOMMODATED**  
 Example: 1216 will accommodate size 12 through 16 AWG wire.

**MATING END**  
 (P = Pin, S = Socket)

**BULK PACKAGED**

**"X" INDICATES PLATING**  
 4- Silver Plate .0002 min. over Copper .00005 min.  
 5- Gold Plate .00003 min. over Nickel .00005 min.

NOTE: The 10SL, 12S, 14S, 16S connectors with socket contacts require short contact denoted by 9755-XXXX-XX part number.

NOTE: Order termination tools separately, see page 25.



## 97 Contact Code Table\*

Wire Range**	Contact Code	Pin	Contact Code	Socket	Contact Code	Socket
1622	A	97-45-1622P-X(XXX)	B	97-55-1622S-X(XXX)	C	97-45-1622S-X(XXX)
1418	D	97-45-1418P-X(XXX)	E	97-55-1418S-X(XXX)	F	97-45-1418S-X(XXX)
2026	G	97-45-2026P-X(XXX)	H	97-55-2026S-X(XXX)	I	97-45-2026S-X(XXX)
2630	J	97-45-2630P-X(XXX)	K	97-55-2630S-X(XXX)	L	97-45-2030S-X(XXX)
1216	M	97-38-1216P-X(XXX)			O	97-38-1216S-X(XXX)

\*See Order Information for bulk and reel contact deviation numbers.

\*\*Wire range is size of wires contact will accommodate. For example, wire range "1622" will accommodate size 16 through 22.

## Insert/Contact Where Used Table

Insert Arrangement	Contact Qty.	Contact Size	Use Contacts With Code*		Insert Arrangement	Contact Qty.	Contact Size	Use Contacts With Code*	
			Pin	Socket				Pin	Socket
10SL-3	3	16	A,D,G,J	B,E,H,K	18-20	5	16	A,D,G,J	C,F,I,L
10SL-4	2	16	A,D,G,J	B,E,H,K	20-4	4	12	M	O
12S-3	2	16	A,D,G,J	B,E,H,K	20-7	8	16	A,D,G,J	C,F,I,L
14S-1	3	16	A,D,G,J	B,E,H,K	20-27	14	16	A,D,G,J	C,F,I,L
14S-2	4	16	A,D,G,J	B,E,H,K	22-14	19	16	A,D,G,J	C,F,I,L
14S-5	5	16	A,D,G,J	B,E,H,K	24-2	7	12	M	O
14S-7	3	16	A,D,G,J	B,E,H,K	28-11	4	12	M	O
16S-1	7	16	A,D,G,J	B,E,H,K		18	16	A,D,G,J	C,F,I,L
16S-8	5	16	A,D,G,J	B,E,H,K	28-12	26	16	A,D,G,J	C,F,I,L
18-1	10	16	A,D,G,J	C,F,I,L	28-20	10	12	M	O
18-4	4	16	A,D,G,J	C,F,I,L		4	16	A,D,G,J	C,F,I,L
18-11	5	12	M	O	28-21	37	16	A,D,G,J	C,F,I,L
18-12	6	16	A,D,G,J	C,F,I,L	32-414	52	16	A,D,G,J	C,F,I,L
18-19	10	16	A,D,G,J	C,F,I,L	36-10	48	16	A,D,G,J	C,F,I,L

Codes in bold letters are most common.

## termination tools

### Insertion/Extraction Tools

Contact Size	16	12
Part Number	M81969/14-03	M81969/14-04

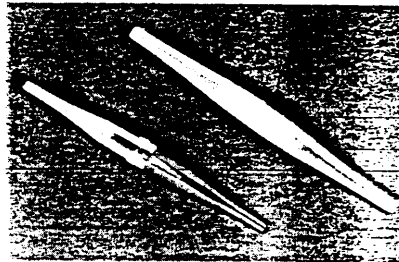

### Crimping Tools

Full Cycle

Part No.	Contact Part Number
357-578	9738-1216X-X Thru 9745-1622X-X
357-579	9745-2026X-X and 9745-2630X-X



### Wire Preparation

Strip wire to length shown in chart. Do not cut or nick wire strands. Twist wire strands back to their original lay.

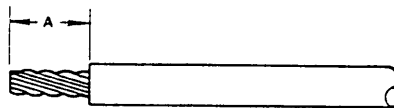

Contact Size	Contact Part No.	Insulation O.D.	Stripping Length "A"
12	9738-1216X-X	.097/.160	.200-.240
16	97XX-1418X-X	.079/.100	.170-.190
16	97XX-1622X-X	.079/.100	.140-.160
16	97XX-2026X-X	.039/.090	.140-.160
16	97XX-2630X-X	.030/.054	.140-.160

Note: XX = 45 or 55

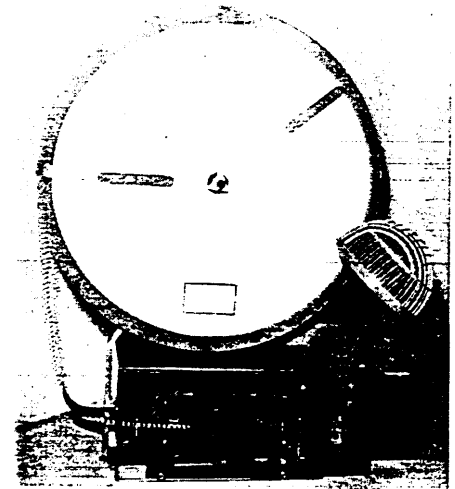

### Strip-Crimp Master

For large production quantities consult Sidney, NY for information on semi-automatic crimping equipment.

Press — 359-634

Tooling Sets

Part No.	Contact Part Number
359-634-200-94	9738-1216X-XXXX contact
359-634-200-95	9745-1418X-XXXX contact
359-634-200-91	9745-1622X-XXXX contact
359-634-200-96	9745-2026X-XXXX contact
359-634-200-97	9745-2630X-XXXX contact

# 97 series MS type connectors for special purposes potting (438 construction)

Potting constructions actually exceed the Type "E" requirements of military specifications for moisture-proof connectors. These constructions replace the back shell completely with a lightweight threaded retainer ring permanently staked to the shell.

To seal the back of the connector, potting compound is injected into an expendable polyethylene potting form and allowed to cure or set. When the form is removed, the resilient, hemispherically shaped insulation extends well into the connector. It forms a chemical bond to the inner and outer walls of the plug, to the back of the insert, around the soldered connections and well out along the leads.

Not only is the back shell eliminated, but also the cable clamp. The solder joints are completely and individually protected by the resilient mass which surrounds them and resists transmittal of vibration to the soldered connections. The completed assembly is not only moistureproof, but also pressurized and resistant to salt water, aircraft lubricating oil, and jet fuels.

## expendable potting forms

For companies not using their own potting molds expendable polyethylene forms can be provided. These expendable forms need no treatment before use. Though designed to be discarded without difficulty, they can be left on assemblies after potting. Nylon potting forms to be left permanently on the assembly are also available. These forms are supplied with construction (824) and (871).

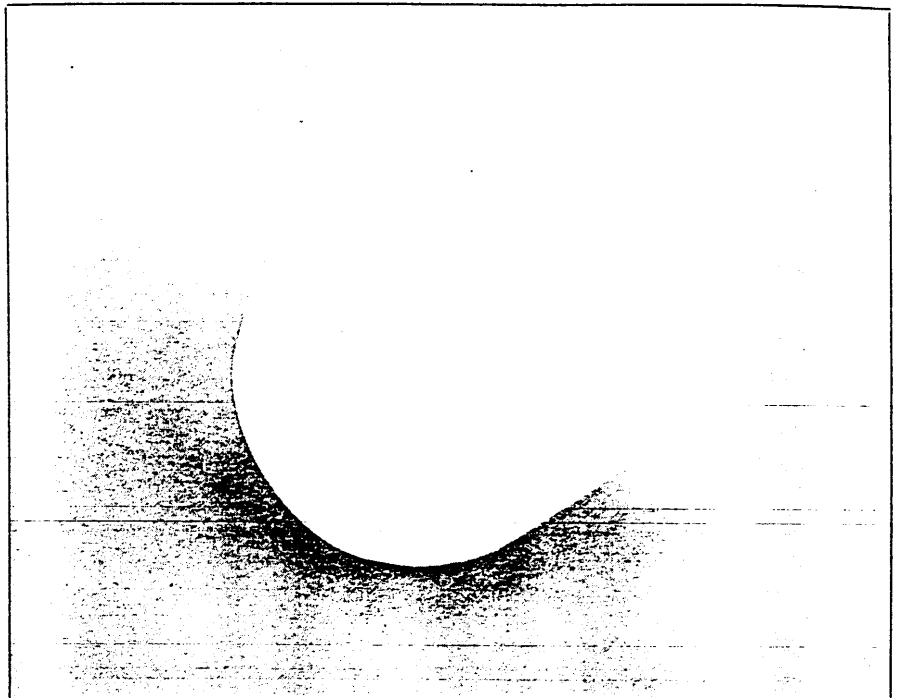

Deviation	Explanation	Shell	Styles
438	Modified "MS", for potting where back shell is replaced by threaded retainer ring. A type "W" washer is included under 3106 coupling ring.	3100 3101	3106 3107
517	New (438) construction having retainer ring type grounding lug. Connectors are marked 97-310X-XX-XX(517).	3100 3101	3106 3107
521	Consists of (438) construction with expendable dust cap on one end. Connector is marked 97-310X-XX-XX(438).	3100 3101	3106 3107
541	Consists of (438) construction with 9755-255-XX expendable poly potting form. Connectors are marked 97-310X-XX-XX(541).	3100 3101	3106 3107
542	(438) construction with grounding lug and expendable poly potting form. Connectors are marked 97-310X-XX-XX(542).	3100 3101	3106 3107
824	Consists of (438) construction plus nylon potting form, bagged marked MS 25183.		3106
826	Consists of (517) construction plus nylon potting form marked MS 25183A.		3106
871	Consists of (438) construction with 9755-271-XX nylon potting form, bagged. Connectors are marked 97-310X-XX-XX(871).	3100 3101	3106 3107

# 97 series MS type connectors for special purposes potting (438 construction) (cont.)

## how to order

To order Amphenol MS connectors in constructions for potting, use the standard MS nomenclature (MS 3100A, MS 3101A, and MS 3106A constructions are available), but

substitute "97" for "MS", drop the "A" suffix for type of back shell, and add the applicable deviation (XXX) as shown on the preceding page. Example: 97-3106-28-16S (438).

# connectors for special purposes box type plugs (97-5105 construction)

97-5105 construction

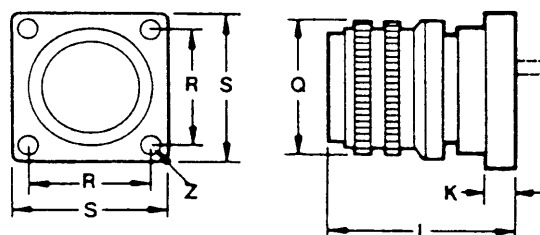

Mounts directly on box or housing. For direct connection of two pieces of equipment without interconnecting wires. Available in all sizes: male or female inserts. To order, complete part number (97-5105) by adding proper insert number.

Example: 97-5105-28-20S. To prevent connector from rotating: Order deviation 205 (single stake, with swivel ring pinned) or 206 (double staking, with both swivel plate and swivel ring pinned). Example: 97-5105-28-20S (205) or 97-5105-28-20S (206).

Connector Size	K		L		Q		R		S		Z Mounting Threads
	Inch	mm	Inch	mm	Inch	mm	Inch	mm	Inch	mm	
8S	1/8	3.18	7/8	22.23	3/4	19.05	9/16	14.27	25/32	19.84	4-36
10S	1/8	3.18	7/8	22.23	7/8	22.23	9/16	14.27	25/32	19.84	4-36
12S	5/32	3.96	31/32	24.59	1	25.40	13/16	20.62	1-1/16	26.97	4-36
12	5/32	3.96	1-3/8	34.93	1	25.40	13/16	20.62	1-1/16	26.97	4-36
14S	5/32	3.96	31/32	24.59	1-1/8	28.56	13/16	20.62	1/16	26.97	4-36
14	5/32	3.96	1-3/8	34.93	1-1/8	28.56	13/16	20.62	1-1/16	26.97	4-36
16S	5/32	3.96	31/32	24.59	1-1/4	31.75	1	25.40	1-5/16	33.32	6-32
16	5/32	3.96	1-13/32	35.71	1-1/4	31.75	1	25.40	1-5/16	33.32	6-32
18	5/32	3.96	1-13/32	35.71	1-11/32	34.11	1	25.40	1-5/16	33.32	6-32
20	3/16	4.75	1-13/32	35.71	1-15/32	37.29	1-1/4	31.75	1-5/8	41.28	10-24
22	3/16	4.75	1-13/32	35.71	1-19/32	40.46	1-1/4	31.75	1-5/8	41.28	10-24
24	3/16	4.75	1-13/32	35.71	1-23/32	43.64	1-9/16	39.67	2	50.80	10-24
28	3/16	4.75	1-13/32	35.71	1-31/32	49.99	1-9/16	39.67	2	50.80	10-24



# 97 series small flange receptacles

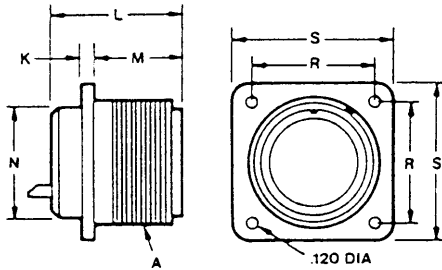

Small flange, (115) construction, receptacles are available in sizes 12S and 14S with pin or socket inserts and in size 10 SL with pin contacts only. To order, complete part number (97-3102) by adding proper insert and construction numbers: 97-3102A12S-4S(115). For pressurized construction (pin contacts only), specify (231) in place of (115).

Connector Size	A Coupling Threads	K Ref.		L Max.		M Ref.		N Ref.		R Ref.		S Ref.	
		Inch	mm	Inch	mm	Inch	mm	Inch	mm	Inch	mm	Inch	mm
10SL	5/8-24	5/64	1.98	55/64	21.82	9/16	14.27	5/8	15.88	.625	15.88	13/16	20.62
12S	3/4-20	3/32	2.36	27/32	21.41	9/16	14.27	5/8	15.88	.664	16.87	7/8	22.23
14S	7/8-20	3/32	2.36	27/32	21.41	9/16	14.27	23/32	18.24	.730	18.54	15/16	23.80

# 97 series ECG connector

For ECG monitoring cable and equipment. Meets requirements of ECG connector standard draft by A.A.M.I. (Association for the Advancement of Medical Instrumentation). Standard number in AAMI ECGC-D 10/75.

7-8905 - 97-3102A14S-6S (639) with insert rotated 30° off normal position between contacts "A" and "F".

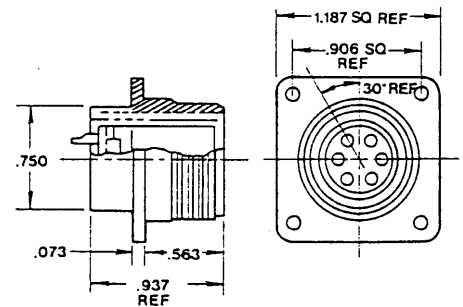

**NOTE:**

This connector is to be used **only** for apparatus as described in the A.A.M.I. Standard "A.A.M.I. ECG Connector Standard." Other uses may result in a possible hazardous connection.

7-8906 - 97-3106A14S-6P (639) with insert rotated 30° off normal position between contacts "A" and "F".

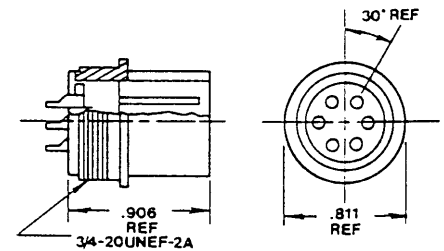

# 97 series MS connector accessories

## cable clamp MS3057A

For jacketed cable or wires protected by tubing. Both clamping halves float for maximum strain relief. For unjacketed cable or wires use corresponding MS 3420 bushing. To order clamp with bushing, add -1 to the 97-number. Two telescoping bushings are furnished with shells sizes 24 and larger. M85049/41-XA supersedes MS3057-XA.

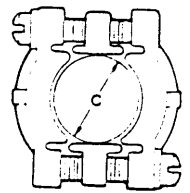
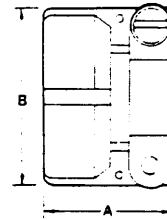
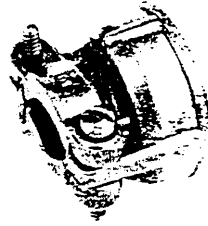

MS Number	Amphenol Number	Shell Size	Max. O.D. Cable		A		B		C		Threads
			Inch	mm	Inch	mm	Inch	mm	Inch	mm	
M85049/41-4A	97-3057-1004	10SL, 12S	5/16	7.92	.795	20.19	.842	21.39	5/16	7.92	5/8-24
M85049/41-6A	97-3057-1007	14, 14S	7/16	11.10	.850	21.59	.995	25.27	7/16	11.10	3/4-20
M85049/41-8A	97-3057-1008	16, 16S	9/16	14.27	.920	23.37	1.120	28.45	9/16	14.27	7/8-20
M85049/41-10A	97-3057-1010	18	5/8	15.88	.920	23.37	1.216	30.89	5/8	15.88	1-20
M85049/41-12A	97-3057-1012	20, 22	3/4	19.05	.927	23.55	1.403	35.64	3/4	19.05	1-3/16-18
M85049/41-16A	97-3057-1016	24, 28	15/16	23.80	1.015	25.78	1.683	42.75	15/16	23.80	1-7/16-18
M85049/41-20A	97-3057-1020	32	1-1/4	31.75	1.095	27.81	2.050	52.07	1-1/4	31.75	1-3/4-18
M85049/41-24A	97-3057-1024	36	1-3/8	34.93	1.156	29.36	2.245	57.02	1-3/8	34.93	2-18

## bushing MS3420

Rubber bushing specifically designed for MS3057A cable clamp. Can also be used as a reducing bushing.

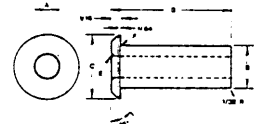

Part Number		A		B		C		D		E		F	
MS	Amphenol	Inch	mm	Inch	mm	Inch	mm	Inch	mm	Inch	mm	Inch	mm
3420-3	9779-513-3	.130	3.30	.210	5.33	.374	9.50	2.875	73.03	1/32	.79	1/32	.79
3420-4	9779-513-4	.220	5.59	.302	7.67	.500	12.70	2.750	69.85	1/32	.79	1/32	.79
3420-6	9779-513-6	.312	7.92	.427	10.85	.614	15.60	2.625	66.68	1/32	.79	1/16	1.57
3420-8	9779-513-8	.437	11.10	.552	14.02	.739	18.77	2.500	63.50	1/16	1.57	1/16	1.57
3420-10	9779-513-10	.562	14.27	.615	15.62	.885	22.58	2.375	60.33	1/16	1.57	1/16	1.57
3420-12	9779-513-12	.625	15.88	.740	18.80	1.084	27.53	2.250	57.15	1/16	1.57	1/16	1.57
3420-16	9779-513-16	.750	19.05	.927	23.55	1.309	26.39	2.125	53.98	1/16	1.57	1/16	1.57
3420-20	9779-513-20	.937	23.80	1.240	31.50	1.591	40.41	2.000	50.80	1/16	1.57	1/16	1.57
3420-24	9779-513-24	1.250	31.75	1.365	34.67	1.842	46.79	1.875	47.63	1/16	1.57	1/16	1.57

## cable clamp - AN 3057

For jacketed cable or wires protected by tubing. Cable or wires should be centered in jaws of clamp for maximum grip. A vinyl or rubber bushing or sleeve may be used for centering. One resilient washer and two fiber washers are included with each clamp.

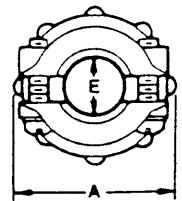
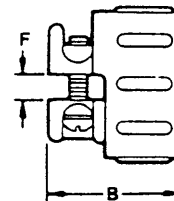
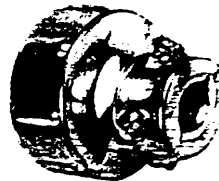

AN Number	Fits Shell Size	Fits AN Fitting Size	Max. O.D. Cable		A		B		E		F		Threads	Weight Lbs. Per 100
			Inch	mm	Inch	mm	Inch	mm	Inch	mm	Inch	mm		
AN 3057-3	8S, 10S	3	1/4	6.35	11/16	17.45	1	25.40	1/4	6.35	1/8	3.18	1/2-28	1.89
AN 3057-4	10SL, 12S	4	5/16	7.92	25/32	19.84	1	25.40	5/16	7.92	3/16	4.75	5/8-24	2.12
AN 3057-6	14, 14S	6	7/16	11.10	15/16	23.80	1-5/64	27.38	7/16	11.10	3/16	4.75	3/4-20	2.94
AN 3057-8	16, 16S	8	9/16	14.27	1-1/16	26.97	1-1/8	28.58	9/16	14.27	9/32	7.14	7/8-20	3.44
AN 3057-10	18	10	5/8	15.88	1-3/16	30.15	1-1/8	28.58	5/8	15.88	5/16	7.92	1-20	4.72
AN 3057-12	20, 22	12	3/4	19.05	1-3/8	34.93	1-3/16	30.15	3/4	19.05	5/16	7.92	1-3/16-18	6.10
AN 3057-16	24, 28	16	15/16	23.80	1-5/8	41.28	1-5/16	33.32	15/16	23.80	3/8	9.53	1-7/16-18	8.71
AN 3057-20	32	20	1-1/4	31.75	1-15/16	49.20	1-1/2	38.10	1-1/4	31.75	1/2	12.70	1-3/4-18	14.85
AN 3057-24	36	24	1-3/4	34.93	2-3/16	55.55	1-9/16	39.67	1-3/8	34.93	19/32	15.06	2-18	18.15
AN 3057-28	40	28	1-5/8	41.28	2-1/2	63.50	1-9/16	39.67	1-5/8	41.28	21/32	16.66	2-1/4-16	21.50

# 97 series MS connector accessories (cont.)

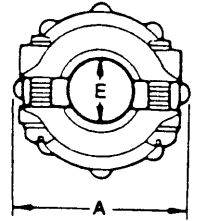
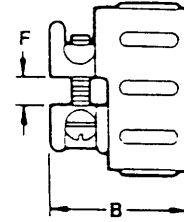

## step down clamp 97-3057

Similar to AN 3057 except step down feature accommodates smaller cable.

Amphenol Number	Fits Shell Size	Fits AN Fitting Size	Max. O.D. Cable		A		B		E		F		Threads	Weight Lbs. Per 100
			Inch	mm	Inch	mm	Inch	mm	Inch	mm	Inch	mm		
97-3057-10-6	18	10	1/2	12.70	1-3/16	30.15	1-1/8	28.58	7/16	11.10	3/16	4.75	1-20	3.94
97-3057-12-6	20, 22	12	1/2	12.70	1-3/8	34.93	1-3/16	30.15	7/16	11.10	3/16	4.75	1-3/16-18	4.40

**waterproof cable clamps - 9767 for MS connectors - 9767 assembly includes AN 3057 clamp, rubber bushing, washer and AN 3055 adapter.** To assure watertight integrity of the connector assembly, the plug must be ordered with deviation (417), which supplies a W washer cemented to the shoulder of the plug shell.

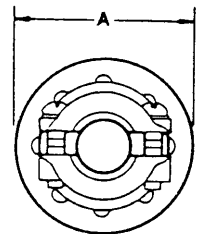
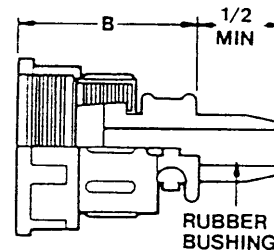
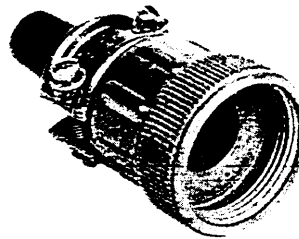

Max. O.D. Cable		Amphenol Number	Connector Size	A		B		Threads	Weight Lbs. Per 100
Inch	mm			Inch	mm	Inch	mm		
7/32	5.54	9767-12-4	10SL, 12S, 12	25/32	19.84	1-17/32	38.89	5/8-24	3.82
		9767-14-4	12SL, 14S, 14	29/32	23.01	1-17/32	38.89	3/4-20	3.87
		9767-16-4	16S, 16	1-1/16	26.97	1-17/32	38.89	7/8-20	4.00
11/32	8.71	9767-14-6	12SL, 14S, 14	29/32	23.01	1-19/32	40.46	3/4-20	5.54
		9767-16-6	16S, 16	1-1/16	26.97	1-19/32	40.46	7/8-20	5.84
		9767-18-6	18	1-3/16	30.15	1-19/32	40.46	1-2	5.94
7/16	11.10	9767-16-8	16S, 16	1-1/16	26.97	1-19/32	40.46	7/8-20	6.92
		9767-18-8	18	1-3/16	30.15	1-19/32	40.46	1-20	7.10
		9767-22-8	20, 22	1-3/8	34.93	1-19/32	40.46	1-3/16-18	7.27
9/16	14.27	9767-18-10	18	1-3/16	30.15	1-19/32	40.46	1-20	8.79
		9767-22-10	20, 22	1-3/8	34.93	1-19/32	40.46	1-3/16-18	8.97
		9767-28-10	24, 28	1-5/8	41.28	1-17/32	38.89	1-7/16-18	9.12
11/16	17.45	9767-22-12	20, 22	1-3/8	34.93	1-21/32	42.06	1-3/16-18	12.65
		9767-28-12	24, 28	1-5/8	41.28	1-21/32	42.06	1-7/16-18	12.86
27/32	21.41	9767-28-16	24, 28	1-5/8	41.28	1-25/32	45.24	1-7/16-18	14.95
		9767-36-16	36	2-3/16	55.56	1-31/32	50.00	2-18	16.36
1-1/32	26.19	9767-32-20	32	1-15/16	49.20	1-31/32	50.00	1-3/4-18	22.27

## cable clamps - for AN fittings

In selecting a cable clamp for a connection with fittings, the 9767 clamp with the adapter may be used.

Max. Cable O.D.		Amphenol Number	Fitting Size	A		B		Threads	Weight Lbs. Per 100
Inch	mm			Inch	mm	Inch	mm		
7/32	5.54	9767-4	4	25/32	19.84	1	25.40	5/8-24	2.45
11/32	8.71	9767-6	6	29/32	23.01	1-5/64	27.38	3/4-20	3.94
7/16	11.10	9767-8	8	1-1/16	26.97	1-1/8	28.58	7/8-20	4.57
9/16	14.27	9767-10	10	1-3/16	30.15	1-1/8	28.58	1-20	5.97
11/16	17.45	9767-12	12	1-3/8	34.93	1-3/16	30.15	1-3/16-18	7.85
27/32	21.41	9767-16	16	1-5/8	41.28	1-5/16	33.32	1-7/16-18	9.53

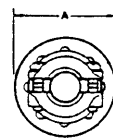
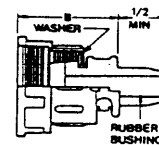

# 97 series MS connector accessories cap and chain assemblies

Fit MS and 97 type receptacles and plugs. Provide protection against live circuits and keep out dirt and dust when connector is not in use.

Two styles are available: one with a stainless steel link chain, and one with a beaded chain. Both use the same caps and both have a cadmium olive drab finish.

Caps for receptacles have internal threads and used on MS-3102, MS-3101, and MS-3100 receptacles. A soft rubber disc seats on the connector shell forming a watertight joint. Caps for plugs have external threads for use on all plugs where a coupling nut is provided (MS-3106 and MS-3108).

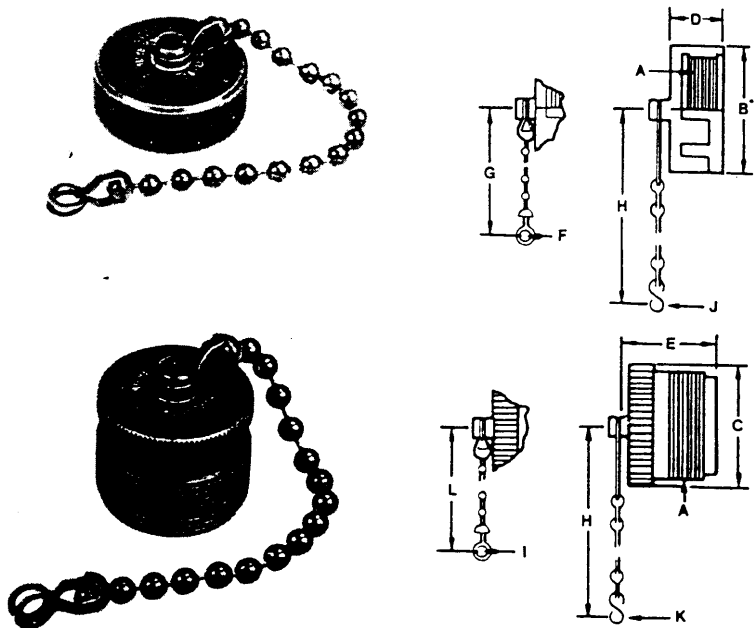

## cap & chain assemblies

For Receptacles		For Plugs		For Connector Size	A Threads	B*		C		D*		E	
Link Chain	Bead Chain	Link Chain	Bead Chain			Inch	mm	Inch	mm	Inch	mm	Inch	mm
9760-908	9760-8	9760-808	9760-8P	8S	1/2-28	5/8	15.88	1/2	12.70	7/16	11.10	21/32	16.66
-910	-10	-810	-10P	10S, 10SL	5/8-24	13/16	20.62	5/8	15.88	7/16	11.10	21/32	16.66
-912	-12	-812	-12P	12, 12S, 12SL	3/4-20	15/16	23.80	3/4	19.05	7/16	11.10	27/32	21.41
-914	-14	-814	-14P	14, 14S	7/8-20	1-1/16	26.97	7/8	22.23	7/16	11.10	27/32	21.41
-916	-16	-816	-16P	16, 16S	1-20	1-1/8	28.58	1	25.40	7/16	11.10	27/32	21.41
-918	-18	-818	-18P	18	1-1/8-18	1-5/16	33.32	1-1/8	28.58	7/16	11.10	27/32	21.41
-920	-20	-820	-20P	20	1-1/4-18	1-7/16	36.50	1-1/4	31.75	7/16	11.10	27/32	21.41
-922	-22	-822	-22P	22	1-3/8-18	1-9/16	39.67	1-3/8	34.93	7/16	11.10	27/32	21.41
-924	-24	-824	-24P	24	1-1/2-18	1-11/16	42.85	1-1/2	38.10	7/16	11.10	27/32	21.41
-928	-28	-828	-28P	28	1-3/4-18	1-59/64	48.79	1-3/4	44.45	1/2	12.70	27/32	21.41
-932	-32	-832	-32P	32	2-18	2-3/16	55.55	2	50.80	1/2	12.70	27/32	21.41
-936	-36	-836	-36P	36	2-1/4-16	2-7/16	61.90	2-1/4	57.15	1/2	12.70	27/32	21.41

For Connector Size	F		G		H ± 1 LINK		I		J		K		L	
	Inch	mm	Inch	mm	Inch	mm	Inch	mm	Inch	mm	Inch	mm	Inch	mm
8S	125	3.18	2-9/16	65.07	4.0	101.60	125	3.18	140	3.56	156	3.96	2-9/16	65.07
10S, 10SL	125	3.18	2-9/16	65.07	4.0	101.60	125	3.18	140	3.56	156	3.96	2-13/16	71.44
12, 12S, 12SL	125	3.18	2-9/16	65.07	4.5	114.30	125	3.18	140	3.56	156	3.96	3-13/16	96.84
14, 14S	125	3.18	2-9/16	65.07	4.5	114.30	125	3.18	140	3.56	156	3.96	3-13/16	96.84
16, 16S	167	4.24	4-5/8	117.48	4.5	114.30	167	4.24	140	3.56	156	3.96	4-5/8	117.48
18	167	4.24	4-5/8	117.48	4.5	114.30	167	4.24	140	3.56	156	3.96	4-5/8	117.48
20	167	4.24	4-5/8	117.48	5.0	127.00	167	4.24	140	3.56	187	4.75	4-5/8	117.48
22	167	4.24	4-5/8	117.48	5.0	127.00	167	4.24	140	3.56	187	4.75	4-5/8	117.48
24	167	4.24	4-5/8	117.48	5.5	139.70	167	4.24	171	4.34	187	4.75	4-5/8	117.48
28	167	4.24	4-5/8	117.48	7.75	196.85	167	4.24	171	4.34	187	4.75	4-5/8	117.48
32	190	4.83	5-3/4	146.05	7.75	196.85	260	6.60	187	4.75	218	5.54	5-3/4	146.05
36	190	4.83	5-3/4	146.05	7.75	196.85	260	6.60	187	4.75	218	5.54	5-3/4	146.05

\*B dimension 1/16 inch less and D dimension 1/64 inch less for screw machine parts, sizes 8 thru 22.  
†Caps less chains are available. To order, add G to the part number: for example, 9760-8G.

# protective caps for MS connectors 97121

## protective caps for MS connectors — 97121

MS 90376 Expendable polyethylene dust caps provide added protection for precision-built MS connectors during storage and handling, in assembling with other equipment, and after complete assembly into a finished apparatus. Protective caps cover threaded sections of plugs and

receptacles; assure against damage to thread from any cause; permit low-cost, attractive coverings which protect contacts and the insulation from dust, dirt and handling damage. When ordering MS connectors, specify MS connectors with protective caps. See ordering instructions below.

### order information

In ordering new connectors it is best to arrange to have the connectors arrive at your plant with caps assembled. This will assure you of protection against thread damage, dust and foreign matter in transit, in your stock and on your assembly line until the connectors are finally mated. To order connectors complete with protective caps assembled to both ends, specify

(258) after the connector number; for example, MS 3106A20-20P (258), MS 3102A20-20S (258). For connectors in stock or on your production line you may order the caps separately by use of the tabulation below.

### type 97121-4XXY

For engagement with internal threads of coupling rings.

### type 97121-4XXR

For engagement with external threads for coupling and fitting threads.

## TYPES AND SIZES REQUIRED

For Type MS3100

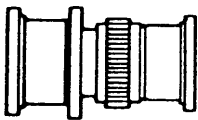

For Type MS3101

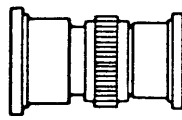

For Type MS3102

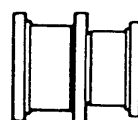

For Type MS3106

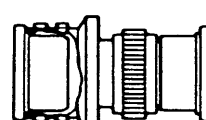

For Type MS3108

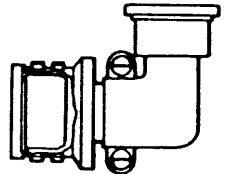

Connector Size	Mating End	Termination End	Mating End	Termination End	Mating End	Termination End	Mating End	Termination End	Mating End	Termination End
8S	—408R	—408R	—408R	—408R	—408R	—408R	—408Y	—408R	—408Y	—408R
10S	—410R	—408R	—410R	—408R	—410R	—408R	—410Y	—408R	—410Y	—408R
10SL	—410R	—410R	—410R	—410R	—410R	—410R	—410Y	—410R	—410Y	—410R
12S-12	—412R	—410R	—412R	—410R	—412R	—410R	—412Y	—410R	—412Y	—410R
14S-14	—414R	—412R	—414R	—412R	—414R	—412R	—414Y	—412R	—414Y	—412R
16S-16	—416R	—414R	—416R	—414R	—416R	—414R	—416Y	—414R	—416Y	—414R
18	—418R	—416R	—418R	—416R	—418R	—416R	—418Y	—416R	—418Y	—416R
20	—420R	—420Y	—420R	—420Y	—420R	—418R	—420Y	—420Y	—420Y	—420Y
22	—422R	—420Y	—422R	—420Y	—422R	—420R	—422Y	—420Y	—422Y	—420Y
24	—424R	—424Y	—424R	—424Y	—424R	—422R	—424Y	—424Y	—424Y	—424Y
28	—428R	—424Y	—428R	—424Y	—428R	—428R	—428Y	—424Y	—428Y	—424Y
32	—432R	—428R	—432R	—428R	—432R	—432R	—432Y	—428R	—432Y	—428R
36	—436R	—432R	—436R	—432R	—436R		—436Y	—432R	—436Y	—432R
40	—440R	—436R	—440R	—436R	—440R		—440Y	—436R	—440Y	—436R

**NOTE:** A complete part number consists of type number 97121 and the size indicated by a dash number such as —408R, or —440Y. Examples of complete part numbers: 97121—408R, 97121—440Y, etc.



# 97 series MS connector accessories

Made to military standards. Many fittings have the official "AN" part number plainly stamped or cast on them. The military marking arrangement consists of a class number (type of fitting) and dash number (size). Example: AN3066-12. The AN 3066-12 is the general classification of hexagon locknuts, and the -12 is the size for 3/4" conduit.

**adapter - AN 3055**  
Used as reducing or extending bushing.

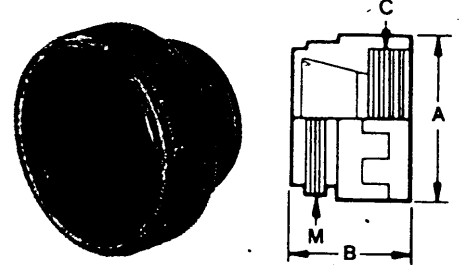

## adapters for MS connectors - AN 3055

Conduit Size		AN Number	Used On Connector Sizes	A		B		C Threads	M Threads	Weight Lbs. Per 100
Inch	mm			Inch	mm	Inch	mm			
1/4	6 35	AN3055-12-4	12S. 12	25/32	18 24	7/8	22 23	5/8-24	5/8-24	1 37
		AN3055-14-4	14S. 14	29/32	23 01	7/8	22 23	3/4-20	5/8-24	1 42
3/8	9 53	AN3055-14-6	14S. 14	29/32	23 01	7/8	22 23	3/4-20	3/4-20	1 60
		AN3055-16-6	16S. 16	1-1/16	26 97	7/8	22 23	7/8-20	3/4-20	1 90
		AN3055-18-6	18	1-3/16	30 15	7/8	22 23	1-20	3/4-20	2 00
1/2	12 70	AN3055-16-8	16S. 16	1-1/16	26 97	7/8	22 23	7/8-20	7/8-20	2 35
		AN3055-18-8	18	1-3/16	30 15	7/8	22 23	1-20	7/8-20	2 53
		AN3055-22-8	20. 22	1-3/8	34 93	7/8	22 23	1-3/16-18	7/8-20	2 70
5/8	17 88	AN3055-18-10	18	1-3/16	30 15	7/8	22 23	1-20	1-20	2 82
		AN3055-22-10	20. 22	1-3/8	34 93	7/8	22 23	1-3/16-18	1-20	3 00
		AN3055-28-10	24. 28	1-5/8	41 28	7/8	22 23	1-7/16-18	1-20	3 15
3/4	19 05	AN3055-22-12	20. 22	1-3/8	34 93	7/8	22 23	1-3/16-18	1-3/16-18	4 80
		AN3055-28-12	24. 28	1-5/8	41 28	7/8	22 23	1-7/16-18	1-3/16-18	5 01
1	25 40	AN3055-28-16	24. 28	1-5/8	41 28	7/8	22 23	1-7/16-18	1-7/16-18	5 42
		AN3055-32-16	32	1-15/16	49 20	15/16	23 80	1-3/4-18	1-7/16-18	5 60
		AN3055-36-16	36	2-3/16	55 55	1-1/16	26 97	2-18	1-7/16-18	5 73

**conduit box connector - AN 3064**  
Used with AN 3066 locknut to form termination at conduit boxes or panel.  
May be used with AN-3057 clamp to relieve strain on wiring cable terminals.

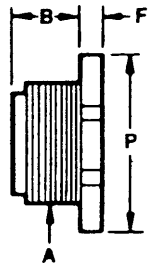

## conduit box connectors - AN 3064

Conduit Size		AN Number	Use Conduit Coupling Lock Nut Size	Use Conduit Coupling Nut Size	A		B		F		P		Weight Lbs. Per 100
Inch	mm				Threads	Inch	mm	Inch	mm	Inch	mm		
1/4	6 35	AN3064-4	AN3066-4	AN3054-4	5/8-24	3/4	19 05	1/8	3 18	13/16	20 62	1 75	
3/8	9 53	AN3064-6	AN3066-6	AN3054-6	3/4-20	3/4	19 05	1/8	3 18	15/16	23 80	2 18	
1/2	12 70	AN3064-8	AN3066-8	AN3054-8	7/8-20	7/8	22 23	3/16	4 75	1-1/16	26 97	3 15	
5/8	17 88	AN3064-10	AN3066-10	AN3054-10	1-20	7/8	22 23	3/16	4-75	1-1/4	31 75	3 94	
3/4	19 05	AN3064-12	AN3066-12	AN3054-12	1-3/16-18	7/8	22 23	3/16	4 75	1-3/8	34 93	4 98	

# 97 series MS connector accessories (cont.)

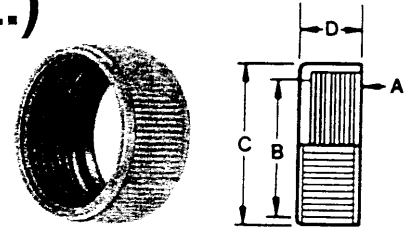

conduit coupling nut - AN3054

Max. Conduit Size		AN Number	MS Connector Size	AN Conduit Fitting Size	A Threads	B		C		D		Weight Lbs. Per 100
Inch	mm					Inch	mm	Inch	mm	Inch	mm	
3/8	9.53	AN3054-6	14, 14S	6	3/4-20	.583	14.81	27/32	21.41	7/16	11.10	70
5/8	17.88	AN3054-10	18	10	1-20	.833	21.16	1-1/8	28.58	7/16	11.10	1.31
3/4	19.05	AN3054-12	20, 22	12	1-3/16-18	.933	23.70	1-5/16	33.32	7/16	11.10	1.60
1	25.40	AN3054-16	24, 28	16	1-7/16-18	1.278	32.46	1-9/16	39.67	7/16	11.10	1.90

conduit coupling lock nut - AN3066

Conduit Size		AN Number	A		F		P		Q		Weight Lbs. Per 100
Inch	mm		Threads	Inch	mm	Inch	mm	Inch	mm		
1/4	6.35	AN3066-4	5/8-24	1/8	3.18	13/16	20.62	15/16	23.80	27.80	36
3/8	9.53	AN3066-6	3/4-20	1/8	3.18	15/16	23.80	1-3/32	27.76	27.76	41
1/2	12.70	AN3066-8	7/8-20	3/16	4.75	1-1/16	26.97	1-15/64	31.34	31.34	72
5/8	15.88	AN3066-10	1-20	3/16	4.75	1-1/4	31.75	1-7/16	34.21	34.21	86
3/4	19.05	AN3066-12	1-3/16-18	3/16	4.75	1-3/8	34.93	1-19/32	40.46	40.46	101

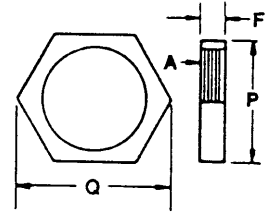

dummy receptacle shells - 97-181

For Connector Size	MS Number	Amphenol Number	A		B		C		D	
			Inch	mm	Inch	mm	Inch	mm	Inch	mm
10S	MS3105-10S	97-181-10S	.562	14.27	.375	9.53	.719	18.26	1.000	25.40
12S	MS3105-12S	97-181-12S	.562	14.27	.375	9.53	.812	20.62	1.094	27.79
14S	MS3105-14S	97-181-14S	.562	14.27	.375	9.53	.906	23.01	1.188	30.18
16S	MS3105-16S	97-181-16S	.750	19.05	.375	9.53	.969	24.61	1.281	32.54
16	MS3105-16	97-181-16	.750	19.05	.625	15.88	.969	24.61	1.281	32.54
18	MS3105-18	97-181-18	.750	19.05	.625	15.88	1.062	26.97	1.375	34.93
20	MS3105-20	97-181-20	.750	19.05	.625	15.88	1.156	29.36	1.500	38.10
22	MS3105-22	97-181-22	.750	19.05	.625	15.88	1.250	31.75	1.625	41.28
24	MS3105-24	97-181-24	.812	20.62	.625	15.88	1.375	34.92	1.750	44.45
28	MS3105-28	97-181-28	.812	20.62	.625	15.88	1.562	39.67	2.000	50.80
32	MS3105-32	97-181-32	.875	22.23	.625	15.88	1.750	44.45	2.250	57.15

dummy receptacle - 97-181

Same as MS receptacle less installation and contacts. Used to anchor MS plugs when not in use.

dummy receptacle shells - 97-181

For Connector Size	E Dia.		F Threads	Mtg. Flange Thickness				Weight Lbs. Per 100
	Inch	mm		Max.		Min.		
10S	.120	3.05	5/8-24	.156	3.96	.078	1.98	1.10
12S	.120	3.05	3/4-20	.156	3.96	.078	1.98	1.73
14S	.120	3.05	7/8-20	.156	3.96	.078	1.98	2.00
16S	.120	3.05	1-20	.156	3.96	.078	1.98	2.35
16	.120	3.05	1-20	.156	3.96	.078	1.98	3.10
18	.120	3.05	1-1/8-16	.203	5.16	.094	2.39	3.18
20	.120	3.05	1-1/4-18	.203	5.16	.094	2.39	3.80
22	.120	3.05	1-3/8-18	.203	5.16	.094	2.39	4.50
24	.147	3.73	1-1/2-18	.203	5.16	.094	2.39	5.00
28	.147	3.73	1-3/4-18	.203	5.16	.094	2.39	6.58
32	.173	4.39	2-18	.359	9.12	.125	3.18	9.75

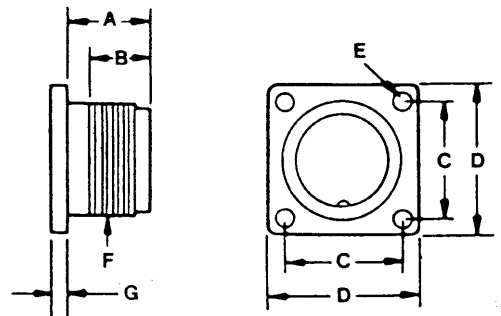

# 97 series accessories

## metal protection caps

### 9760 Caps and Chain Assemblies

Fit MS and 97 type receptacles and plugs; provide protection against live circuits and keep out dirt and dust when connector is not in use.

Two styles are available: one with a stainless steel link chain, and one with a beaded chain. Both use the same caps and both have a cadmium olive drab finish.

Caps for receptacles have internal threads and are used on MS3102, MS3101, and MS3100 receptacles. A soft rubber disc seats on the connector shell, forming a water-tight joint.

Caps for plugs have external threads for use on all plugs where a coupling nut is provided (MS3106 and MS3108).

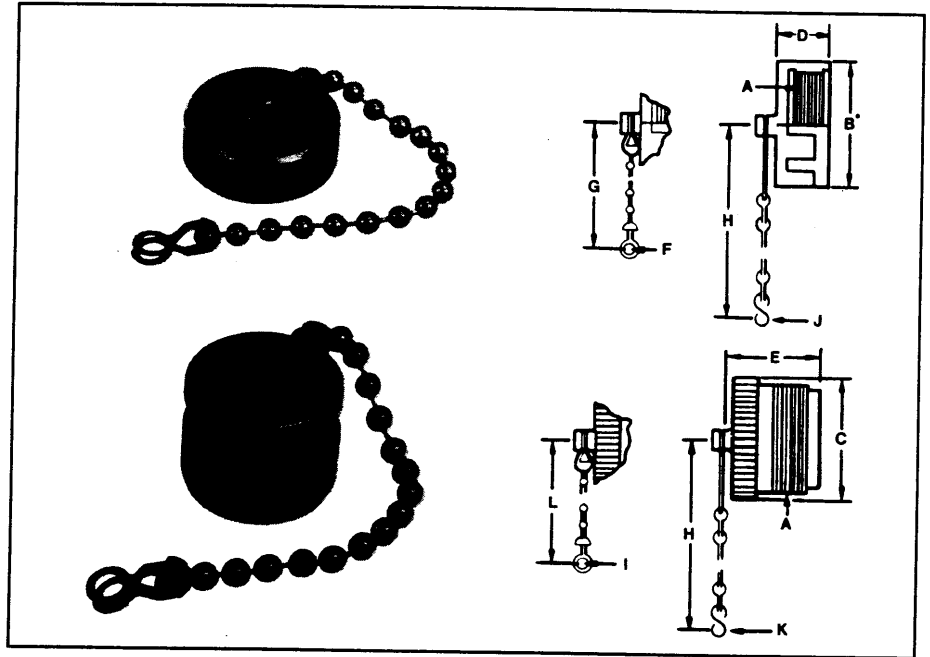

For Receptacles†		For Plugs†		For Connector Size	A Threads	B*		C		D*		E	
Link Chain	Bead Chain	Link Chain	Bead Chain			Inch	mm	Inch	mm	Inch	mm	Inch	mm
9760-908	9760-8	9760-808	9760-8P	8S	1/2-28	5/8	15.88	1/2	12.70	7/16	11.10	21.32	16.66
9760-910	9760-10	9760-810	9760-10P	10S, 10SL	5/8-24	13/16	20.62	5/8	15.88	7/16	11.10	21/32	16.66
9760-912	9760-12	9760-812	9760-12P	12, 12S, 12SL	3/4-20	15/16	23.80	3/4	19.05	7/16	11.10	27/32	21.41
9760-914	9760-14	9760-814	9760-14P	14, 14S	7/8-20	1-1/16	26.97	7/8	22.23	7/16	11.10	27/32	21.41
9760-916	9760-16	9760-816	9760-16P	16, 16S	1 -20	1-1/8	28.58	1	25.40	7/16	11.10	27/32	21.41
9760-918	9760-18	9760-818	9760-18P	18	1-1/8-18	1-5/16	33.32	1-1/8	28.58	7/16	11.10	27/32	21.41
9760-920	9760-20	9760-820	9760-20P	20	1-1/4-18	1-7/16	36.50	1-1/4	31.75	7/16	11.10	27/32	21.41
9760-922	9760-22	9760-822	9760-22P	22	1-3/8-18	1-9/16	39.67	1-3/8	34.93	7/16	11.10	27/32	21.41
9760-924	9760-24	9760-824	9760-24P	24	1-1/2-18	1-11/16	42.85	1-1/2	38.10	7/16	11.10	27/32	21.41
9760-928	9760-28	9760-828	9760-28P	28	1-3/4-18	1-59/64	48.79	1-3/4	44.45	1/2	12.70	27/32	21.41
9760-932	9760-32	9760-832	9760-32P	32	2 -18	2-3/16	55.55	2	50.80	1/2	12.70	27/32	21.41
9760-936	9760-36	9760-836	9760-36P	36	2-1/4-16	2-7/16	61.90	2-1/4	57.15	1/2	12.70	27/32	21.41

For Connector Size	F		G		H ± 1 Link		I		J		K		L	
	Inch	mm	Inch	mm	Inch	mm	Inch	mm	Inch	mm	Inch	mm	Inch	mm
8S	.125	3.18	2-9/16	65.07	4.0	101.60	.125	3.18	.140	3.56	.156	3.96	2-9/16	65.07
10S, 10SL	.125	3.18	2-9/16	65.07	4.0	101.60	.125	3.18	.140	3.56	.156	3.96	2-13/16	71.44
12, 12S, 12SL	.125	3.18	2-9/16	65.07	4.5	114.30	.125	3.18	.140	3.56	.156	3.96	3-13/16	96.84
14, 14S	.125	3.18	2-9/16	65.07	4.5	114.30	.125	3.18	.140	3.56	.156	3.96	3-13/16	96.84
16, 16S	.167	4.24	4-5/8	117.48	4.5	114.30	.167	4.24	.140	3.56	.156	3.96	4-5/8	117.48
18	.167	4.24	4-5/8	117.48	4.5	114.30	.167	4.24	.140	3.56	.156	3.96	4-5/8	117.48
20	.167	4.24	4-5/8	117.48	5.0	127.00	.167	4.24	.140	3.56	.187	4.75	4-5/8	117.48
22	.167	4.24	4-5/8	117.48	5.0	127.00	.167	4.24	.140	3.56	.187	4.75	4-5/8	117.48
24	.167	4.24	4-5/8	117.48	5.5	139.70	.167	4.24	.171	4.34	.187	4.75	4-5/8	117.48
28	.167	4.24	4-5/8	117.48	7.75	196.85	.167	4.24	.171	4.34	.187	4.75	4-5/8	117.48
32	.190	4.83	5-3/4	146.05	7.75	196.85	.260	6.60	.187	4.75	.218	5.54	5-3/4	146.05
36	.190	4.83	5-3/4	146.05	7.75	196.85	.260	6.60	.187	4.75	.218	5.54	5-3/4	146.05

\* B dimension 1/16 inch less, and D dimension 1/64 inch less for screw machine parts, sizes 8 thru 22.

† Caps less chains are available. To order, add G to the part number; for example: 9760-8G.

# 97 series accessories

## polyethylene protection caps

### 97121 Polyethylene Protective Dust Caps

Expendable polyethylene dust caps provide added protection for connectors during storage and handling, in assembling with other equipment, and after complete assembly into a finished apparatus. Protective caps cover threaded sections of plugs and receptacles, assure against damage to threads from any cause; permit low-cost, attractive coverings which protect contacts and the insulation from dust, dirt and handling damage.

### To order connectors complete with caps:

When ordering new connectors, it is best to arrange to have the connectors arrive at your plant with caps assembled. This will assure you of protection against thread damage, dust and foreign matter in transit, in your stock and on your assembly line until the connectors are finally mated. To order connectors complete with protective caps assembled to both ends, specify (258) after the connector number; for example: MS3106A20-20P(258), or MS3102A20-20S(258).

### To order caps separately:

**Type 97121-4XXY** - For engagement with internal threads of coupling rings.  
Example of complete part number: 97121-408Y

**Type 97121-4XXR** - For engagement with external threads for coupling and fitting threads.  
Example of complete part number: 97121-408R

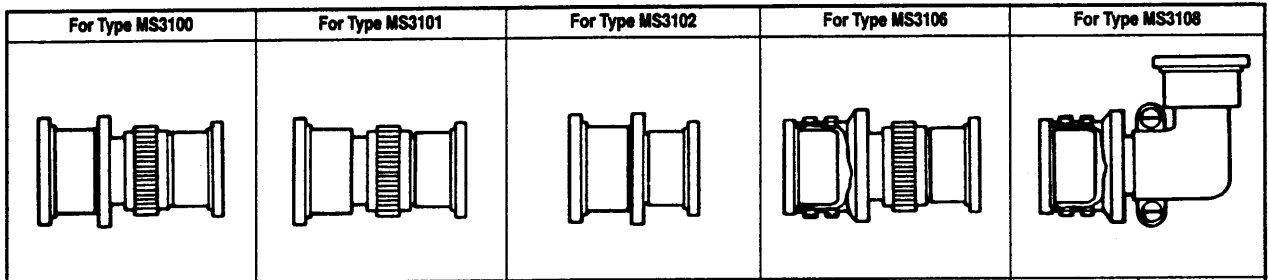

Connector Size	For Type MS3100		For Type MS3101		For Type MS3102		For Type MS3106		For Type MS3108	
	Mating End	Termination End	Mating End	Termination End	Mating End	Termination End	Mating End	Termination End	Mating End	Termination End
8S	-408R	-408R	-408R	-408R	-408R		-408Y	-408R	-408Y	-408R
10S	-410R	-408R	-410R	-408R	-410R	-408R	-410Y	-408R	-410Y	-408R
10SL	-410R	-410R	-410R	-410R	-410R	-410R	-410Y	-410R	-410Y	-410R
12S-12	-412R	-410R	-412R	-410R	-412R		-412Y	-410R	-412Y	-410R
14S-14	-414R	-412R	-414R	-412R	-414R	-412R	-414Y	-412R	-414Y	-412R
16S-16	-416R	-414R	-416R	-414R	-416R	-414R	-416Y	-414R	-416Y	-414R
18	-418R	-416R	-418R	-416R	-418R	-416R	-418Y	-416R	-418Y	-416R
20	-420R	-420Y	-420R	-420Y	-420R	-418R	-420Y	-420Y	-420Y	-420Y
22	-422R	-420Y	-422R	-420Y	-422R	-420R	-422Y	-420Y	-422Y	-420Y
24	-424R	-424Y	-424R	-424Y	-424R	-422R	-424Y	-424Y	-424Y	-424Y
28	-428R	-424Y	-428R	-424Y	-428R		-428Y	-424Y	-428Y	-424Y
32	-432R	-428R	-432R	-428R	-432R		-432Y	-428R	-432Y	-428R
36	-436R	-432R	-436R	-432R	-436R		-436Y	-432R	-436Y	-432R
40	-440R	-436R	-440R	-436R	-440R		-440Y	-436R	-440Y	-436R

# 97 series accessories

## connector adapters

### AN3055 Adapter

Used as reducing or extending bushing.

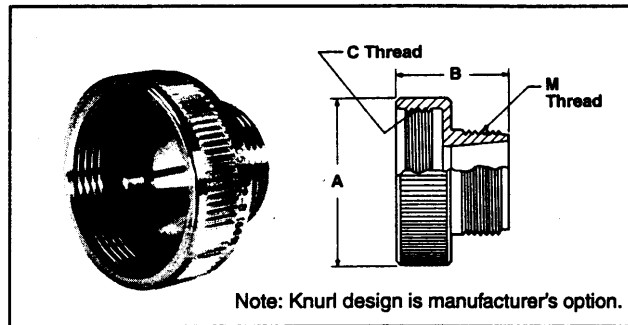

Conduit Size		AN Number	Used on Connector Size	A		B		C Threads	M Threads	Weight Lbs. per 100
Inch	mm			Inch	mm	Inch	mm			
1/4	6.35	AN3055-12-4	12S, 12	25/32	18.24	7/8	22.23	5/8-24	5/8-24	1.37
		AM3055-14-4	14S, 14	29/32	23.01	7/8	22.23	3/4-24	5/8-24	1.42
3/8	9.53	AN3055-14-6	14S, 14	29/32	23.01	7/8	22.23	3/4-20	3/4-20	1.60
		AN3055-16-6	16S, 16	1-1/16	26.97	7/8	22.23	7/8-20	3/4-20	1.90
		AN3055-18-6	18	1-3/16	30.15	7/8	22.23	1 -20	3/4-20	2.00
1/2	12.70	AN3055-16-8	16S, 16	1-1/16	26.97	7/8	22.23	7/8-20	7/8-20	2.35
		AN3055-18-8	18	1-3/16	30.15	7/8	22.23	1 -20	7/8-20	2.53
		AN3055-22-8	20, 22	1-3/8	34.93	7/8	22.23	1-3/16-18	7/8-20	2.70
5/8	17.88	AN3055-18-10	18	1-3/16	30.15	7/8	22.23	1 -20	1 -20	2.82
		AN3055-22-10	20, 22	1-3/8	34.93	7/8	22.23	1-3/16-18	1 -20	3.00
		AN3055-28-10	24, 28	1-5/8	41.28	7/8	22.23	1-7/16-18	1 -20	3.15
3/4	19.05	AN3055-22-12	20, 22	1-3/8	34.93	7/8	22.23	1-3/16-18	1-3/16-18	4.80
		AN3055-28-12	24, 28	1-5/8	41.28	7/8	22.23	1-7/16-18	1-3/16-18	5.01
1	25.40	AN3055-28-16	24, 28	1-5/8	41.28	7/8	22.23	1-7/16-18	1-7/16-18	5.42
		AN3055-32-16	32	1-15/16	49.20	15/16	23.80	1-3/4-18	1-7/16-18	5.60
		AN3055-36-16	36	2-3/16	55.55	1-1/16	26.97	2 -18	1-7/16-18	5.73

### 97-3055-120 Adapter, Type II 97-3055-121 Adapter, Type I

Used to terminate pipe threads.

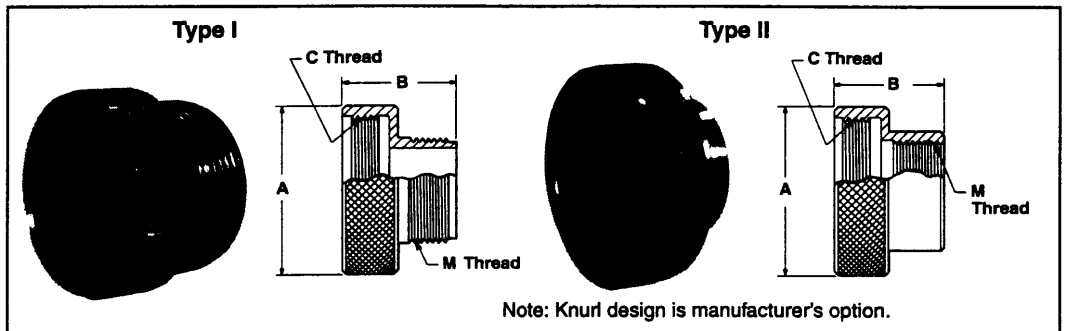

M Thread Size	Type	Part Number	Shell Sizes	A Ref.		B Max.		C Thread
				Inch	mm	Inch	mm	
1/4 NPT	I	97-3055-121-12001	10SL, 12, 12S	25/32	18.24	1-1/8	22.23	5/8-24
1/2 NPT	II	97-3055-120-18002	18,	1-3/16	30.15	1-1/8	22.23	1 -20
		97-3055-120-22002	20, 22	1-3/8	34.93	1-1/8	22.23	1-3/16-18
		97-3055-120-28002	24, 28	1-5/8	41.28	1-1/8	22.23	1-7/16-18
1/2 NPT	I	97-3055-121-22002	20, 22	1-3/8	34.93	1-1/4	25.40	1-3/16-18
		97-3055-121-28002	24, 28	1-5/8	41.28	1-1/4	25.40	1-7/16-18
3/4 NPT	II	97-3055-120-32003	32	1-15/16	49.20	1-3/16	23.80	1-3/4 -18
3/4 NPT	I	97-3055-121-22003	20, 22	1-3/8	34.93	1-1/4	25.40	1-3/16-18
		97-3055-121-28003	24, 28	1-5/8	41.28	1-1/4	25.40	1-7/16-18
1 NPT	I	97-3055-121-28004	24, 28	1-5/8	41.28	1-1/4	25.40	1-7/16-18

# 97 series accessories

## conduit box connectors, conduit coupling nuts

### AN3064 Conduit Box Connector

Used with AN3066 locknut to form termination at conduit boxes or panel. May be used with AN3057 clamp to relieve strain on wiring cable terminals.

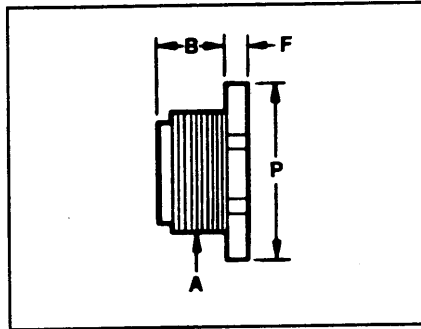

Max. Conduit Size		AN Number	Use Conduit Coupling Lock Nut Size	Use Conduit Coupling Nut Size	A Thread	B		F		P		Weight Lbs. per 100
Inch	mm					Inch	mm	Inch	mm	Inch	mm	
1/4	6.35	AN3064-4	AN3066-4	AN3054-4	5/8-24	5/8	19.05	1/8	3.18	13/16	20.62	1.75
3/8	9.53	AN3064-6	AN3066-6	AN3054-6	3/4-20	5/8	19.05	1/8	3.18	15/16	23.80	2.18
1/2	12.70	AN3064-8	AN3066-8	AN3054-8	7/8-20	11/16	22.23	3/16	4.75	1-1/16	26.97	3.15
5/8	17.88	AN3064-10	AN3066-10	AN3054-10	1 -20	11/16	22.23	3/16	4.75	1-1/4	31.75	3.94
3/4	19.05	AN3064-12	AN3054-12	AN3054-12	1-3/16-18	11/16	22.23	3/16	4.75	1-3/8	34.93	4.98

### AN3054 Conduit Coupling Nut

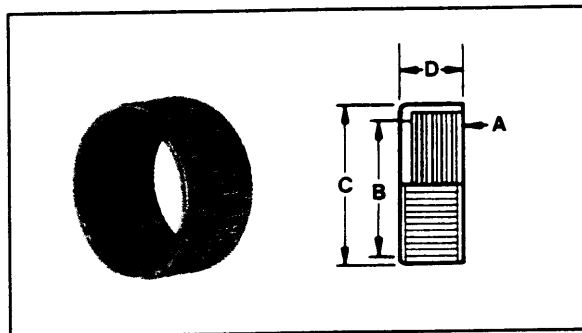

Max. Conduit Size		AN Number	MS Connector Size	AN Conduit Fitting Size	A Thread	B		C		D		Weight Lbs. per 100
Inch	mm					Inch	mm	Inch	mm	Inch	mm	
3/8	9.53	AN3054-6	14, 14S	6	3/4-20	.583	14.81	27/32	21.41	7/16	11.10	.70
5/8	17.88	AN3054-10	18	10	1 -20	.833	21.16	1-1/8	28.58	7/16	11.10	1.31
3/4	19.05	AN3054-12	20, 22	12	1-3/16-18	.933	23.70	1-5/16	33.32	7/16	11.10	1.60
1	25.40	AN3054-16	24, 28	16	1-7/16-18	1.278	32.46	1-9/16	39.67	7/16	11.10	1.90

### AN3066 Conduit Coupling Lock Nut

Conduit Size		AN Number	A Thread	F		P		Q		Weight Lbs. per 100
Inch	mm			Inch	mm	Inch	mm	Inch	mm	
1/4	6.35	AN3066-4	5/8-24	1/8	3.18	13/16	20.62	15/16	23.80	.36
3/8	9.53	AN3066-6	3/4-20	1/8	3.18	15/16	23.80	1-3/32	27.76	.41
1/2	12.70	AN3066-8	7/8-20	3/16	4.75	1-1/16	26.97	1-15/64	31.34	.72
5/8	15.88	AN3066-10	1 -20	3/16	4.75	1-1/4	31.75	1-7/16	34.21	.86
3/4	19.05	AN3066-12	1-3/16-18	3/16	4.75	1-3/8	34.93	1-19/32	40.46	1.01

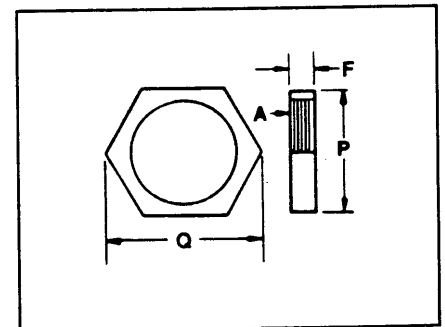

# 97 series accessories

## dummy receptacles

### 97-181 Dummy Receptacle Shells

Same as MS receptacle less insert and contacts.  
Used to anchor MS plugs when not in use.

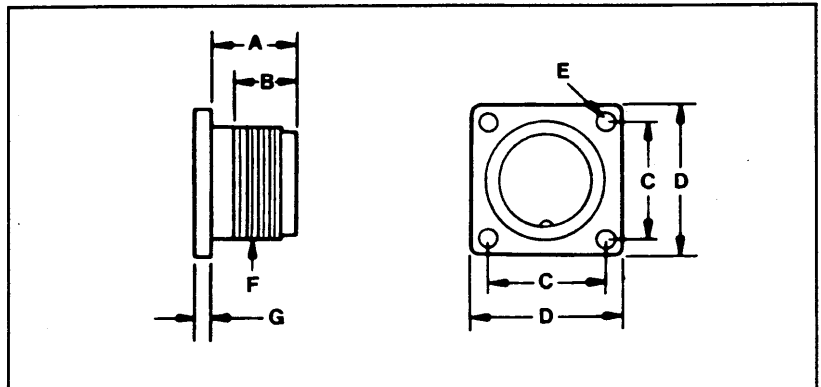

For Connector Size	MS Part Number	Amphenol Part Number	A		B		C		D		E Dia.		F Thread	G Mounting Flange Thickness				Weight Lbs. per 100
			Inch	mm	Inch	mm	Inch	mm	Inch	mm	Inch	mm		Inch	mm	Inch	mm	
10S		97-181-10S	.562	14.27	.375	9.53	.719	18.26	1.000	25.40	.120	3.05	5/8-24	.156	3.96	.078	1.98	1.10
12S		97-181-12S	.562	14.27	.375	9.53	.812	20.62	1.094	27.79	.120	3.05	3/4-20	.156	3.96	.078	1.98	1.73
14S	MS3105-14S	97-181-14S	.562	14.27	.375	9.53	.906	23.01	1.188	30.18	.120	3.05	7/8-20	.156	3.96	.078	1.98	2.00
16S	MS3105-16S	97-181-16S	.562	19.05	.375	9.53	.969	24.61	1.281	32.54	.120	3.05	1 -20	.156	3.96	.078	1.98	2.35
16	MS3105-16	97-181-16	.750	19.05	.625	15.88	.969	24.61	1.281	32.54	.120	3.05	1 -20	.156	3.96	.078	1.98	3.10
18	MS3105-18	97-181-18	.750	19.05	.625	15.88	1.062	26.97	1.375	34.93	.120	3.05	1-1/8-16	.203	5.16	.094	2.39	3.18
20	MS3105-20	97-181-20	.750	19.05	.625	15.88	1.156	29.36	1.500	38.10	.120	3.05	1-1/4-18	.203	5.16	.094	2.39	3.80
22	MS3105-22	97-181-22	.750	19.05	.625	15.88	1.250	31.75	1.625	41.28	.120	3.05	1-3/8-18	.203	5.16	.094	2.39	4.50
24	MS3105-24	97-181-24	.812	20.62	.625	15.88	1.375	34.92	1.750	44.45	.147	3.73	1-1/2-18	.203	5.16	.094	2.39	5.00
28	MS3105-28	97-181-28	.812	20.62	.625	15.88	1.562	39.67	2.000	50.80	.147	3.73	1-3/4-18	.203	5.16	.094	2.39	6.58
32	MS3105-32	97-181-32	.875	22.23	.625	15.88	1.750	44.45	2.250	57.15	.173	4.39	2 -18	.359	9.12	.125	3.18	9.75