

PLUG

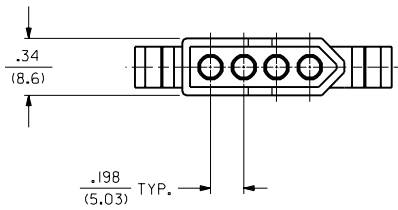
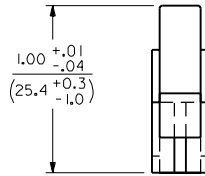
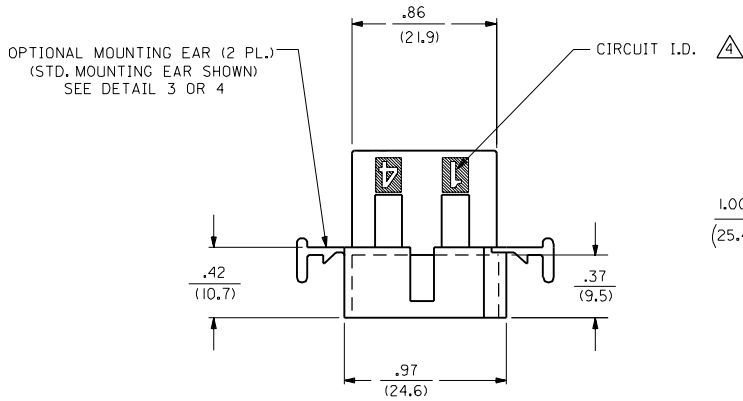
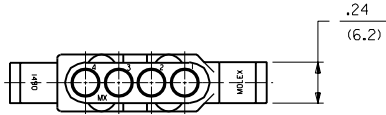

PLUG HOUSING

T	3	T
S	2	T
RI	1	T
R		
P		
MFG.	SH.	REV.
LTR.		REVISIONS

UNLESS OTHERWISE SPECIFIED TOLERANCES: ANGULAR \pm .004

DIMENSIONS SHOWN (METRIC) INCH		UNLESS OTHERWISE SPECIFIED TOLERANCES: ANGULAR \pm .004	
3 PLACE	INCH	2 PLACE	METRIC
± .010	---	± .014	± 0.25
---	---	---	± 0.35

DRAFT WHERE APPLICABLE MUST REMAIN WITHIN DIMENSIONS

DRWG. BY: RAS	CHKD. BY: RW	FILE NAME: SD I490X1 DUN	SCALE: 2 : 1
---------------	--------------	--------------------------	--------------

PART NO. SEE CHART

TITLE: .093/(2.36) HOUSING, PLUG AND RECEPTACLE, 4 CKT. ± .198/(5.03) CTRS.

MOLEX INCORPORATED LITTLE ROCK, ARK. U.S.A.

SHEET NO. 1 OF 3 DATE 3/9/88

DRWG. NO. SD-1490-*

THIS DRAWING CONTAINS INFORMATION THAT IS PROPRIETARY TO MOLEX INC. AND SHOULD NOT BE USED WITHOUT WRITTEN PERMISSION.

T	ADD -PIBU VERSION PER ECN #U3 1537 10-21-93 RW
S	REVISE PER ECR #U1 1686 8/9/91 RW
RI	ADD EDP'S & REVISE SUFFIXES, ECR #U0834 4/24/91 RW
R	REV. LENGTH TOL. ECN #U1 0685 3-22-91 RW
P	REV. & REDRAWN, ECR #U8 1139 GEP 3-8-88 RW

PLUG		RECEPTACLE	
PART NO.	ENG. NO.	PART NO.	ENG. NO.
03-09-2041	I490-P	03-09-1041	I490-R
03-09-2042	I490-P1	03-09-1042	I490-R1
03-09-7041	I490-PBK	03-09-6041	I490-RBK
03-09-7042	I490-P1BK	03-09-6042	I490-R1BK
PRELIMINARY	I490-P2	03-09-1043	I490-R2
03-09-3042	I490-P1BU	03-09-6043	I490-RBU
		03-09-6045	I490-RGN

LEGEND:

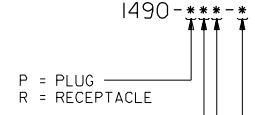

BLANK = WITH STANDARD EARS
 1 = WITHOUT EARS
 2 = WITH PREBENT EARS, PER DETAIL 4

COLOR: BLANK=NATURAL COLOR
 AM=AMBER BK=BLACK BU=BLUE
 BN=BROWN CY=GRAY GN=GREEN
 OR=ORANGE RD=RED YW=YELLOW
 BLANK = MATERIAL CODE A

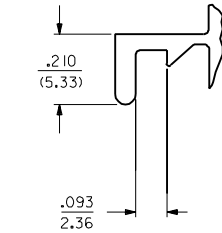

DETAIL 3
 .093/(2.36) STANDARD MOUNTING EAR
 (SCALE 4:1)

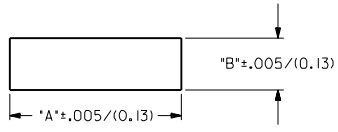
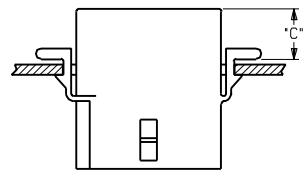

HOUSING	DIM. "A"	DIM. "B"	DIM. "C"
PLUG	1.131/(28.73)	.375/(9.52)	.36/(9.1)
RECEPTACLE	1.038/(26.36)	.312/(7.92)	.37/(9.4)

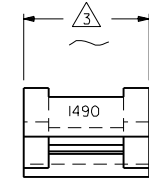

DETAIL 4
 .093/(2.36) PREBENT MOUNTING EAR
 (SCALE 4:1)

NOTES:

- MATERIAL CODES:
A = NYLON 6/6, 94V-2
- THIS PART COMPLIES WITH MOLEX PRODUCT SPEC. 02-09.
- FOR DIMENSION SEE SHEET 1 AND 2.
- CIRCUIT I.D. NUMBERS ON HOUSING APPEAR ON PARTS FROM TOOLS BUILT AFTER 8/7/91.

DIMENSIONS SHOWN (METRIC) INCH		▽ = 0 ▽ = 0		REVISE ONLY ON CAD SYSTEM	
UNLESS OTHERWISE SPECIFIED TOLERANCES ARE: .010 ± .010					
3 PLACE	± .010	---	---	---	---
2 PLACE	± .014	± 0.25	---	---	---
1 PLACE	---	± 0.35	---	---	---
DRAFT WHERE APPLICABLE MUST REMAIN WITHIN DIMENSIONS					
DRWG. BY	CEP	CHK'D. BY	RW		
APP'D. BY	RAS	SCALE	2 : 1		
LTR.	REVISIONS	LTR.	REVISIONS		

TITLE		PART NO.		DATE	
.093/(2.36) HOUSINGS, PLUG AND RECEPTACLE, 4 CKT., .198/(5.03) CTRS.		SD-1490-*		3/10/88	
MOLEX INCORPORATED		SHEET NO. 3		U.S.A.	
SEE CHART		DRWG. NO.			
FILE NAME: SD1490X3.DGN		THIS DRAWING CONTAINS INFORMATION THAT IS PROPRIETARY TO MOLEX INC. AND SHOULD NOT BE USED WITHOUT WRITTEN PERMISSION.		DWN. SIZE: CP C	