





## OVO-3



- Ergonomic designed pocket enclosure with one, two or three push-buttons configuration. The model "Ovo-3/0" has no buttons. Simple interlocking assembly. Space for round PCB (35 mm) with button cell batteries. Mat surface finish.

### COLOURS

.4 (Dark gray RAL 7016)

MODEL		DIMENSIONS mm.		
		L	W	H
	OVO-3/0.4	55	43.7	14
	OVO-3/1.4	55	43.7	14
	OVO-3/2.4	55	43.7	14
	OVO-3/3.4	55	43.7	14

[Download Acrobat ® PDF Drawing](#)

[back <](#)

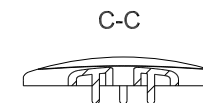
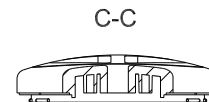
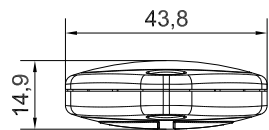
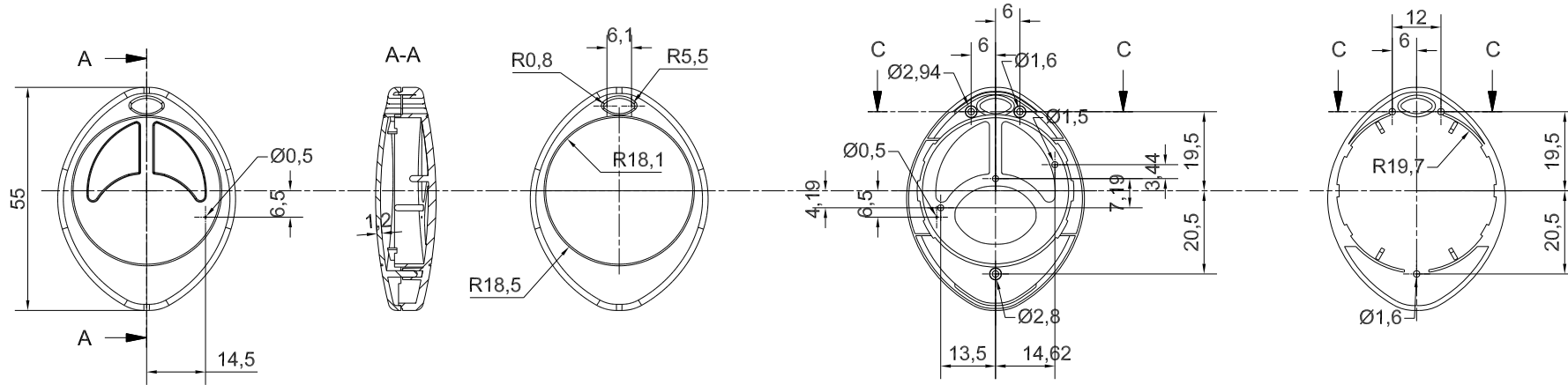
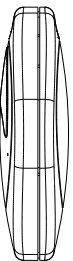

PCB MAX SIZE

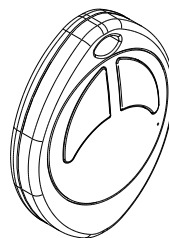
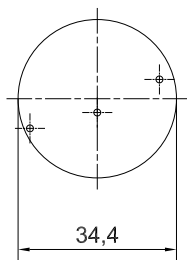

	Denomination	Part. Number	
	<p style="text-align: center;"><b>Assembly OVO-3/2</b></p> <p style="text-align: center;">Subject to technical modification without prior notice. Tipographical and other errors do not justify any claim for damages. All dimensions should be verified using an actual moulded part.</p>	<b>OVO-3/2</b>	
	This document contains proprietary information of <b>TEKO S.p.a.</b> and is tendered subject to the conditions that the information be retained in confidence not be reproduced or copied and not be used or incorporated in any product.		Rev. Index
	Date	Scale	Format design
	10/10/2005		A3