



High Definition Multimedia Interface (HDMI)* Connector System

INTRODUCTION

Molex's new High Definition Multimedia Interface (HDMI) connectors and cable assemblies provide an uncompressed digital link between consumer electronics equipment such as DVD players, set-top boxes and audio/video monitors such as plasma display screens for high-definition TVs.

HDMI is a small, user-friendly interconnect that provides up to 5 Gbps of bandwidth to support high-definition video plus multi-channel audio in a single cable. This system eliminates the cost, complexity and confusion of multiple cables used to connect current A/V systems. Molex offers a full selection of both HDMI connectors and cable assemblies.

Specifications:

- Bandwidth up to 5 Gbps
- 10,000 cycles
- Gold-plated contacts
- Lead-free plating
- Tray and embossed packaging
- Current: 0.5A
- Voltage: 40V



FEATURES AND BENEFITS

- Compact, user-friendly design → Meets Consumer equipment needs
- 5 Gbps bandwidth → Carries uncompressed audio/video in a single cable
- HDMI-DVI cables → DVI backward compatible
- Mounting flange → Protects solder joints; additional grounding
- Signal With Coupled Ground → Low impedance mismatch
- Fully shielded → ESD protection

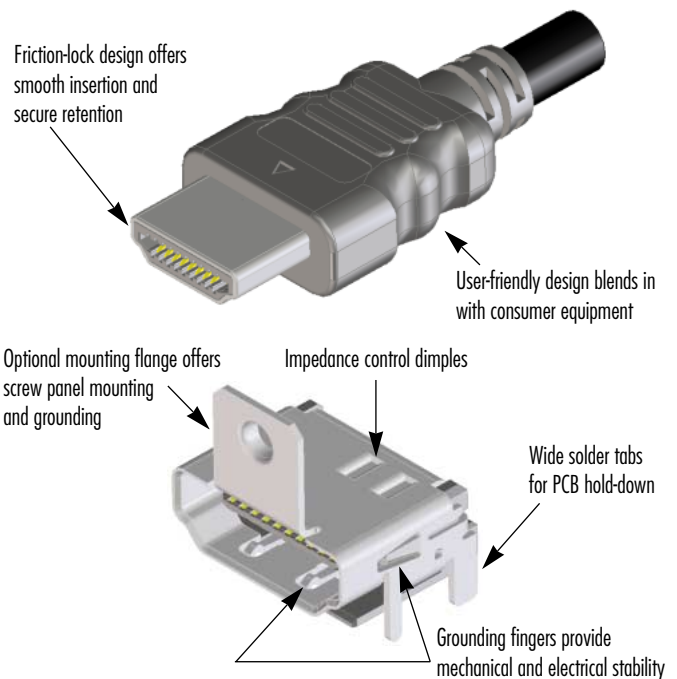
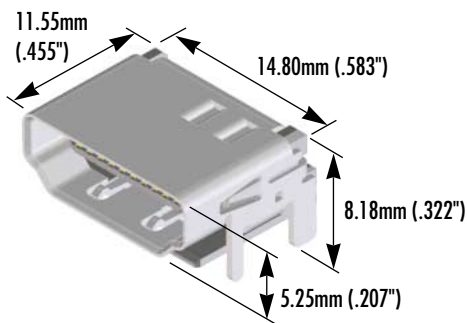

APPLICATIONS

- Digital TVs
- Plasma Displays
- LCDs
- Set-Top Boxes
- DVD Players/Recorders
- Audio/Video Receivers
- D-VHS Players
- High Definition Monitors
- TiVo
- Satellite Boxes

TOPOLOGY

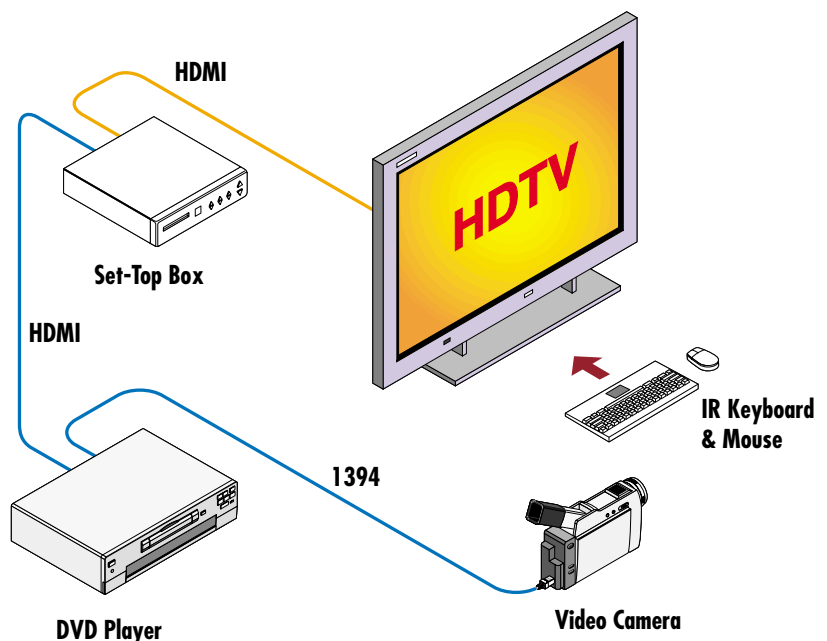

*Note: High Definition Multimedia Interface and HDMI are trademarks of HDMI Licensing, LLC.

See other side for selection chart

PCB Headers

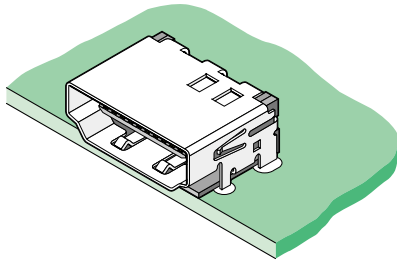

Standard Type

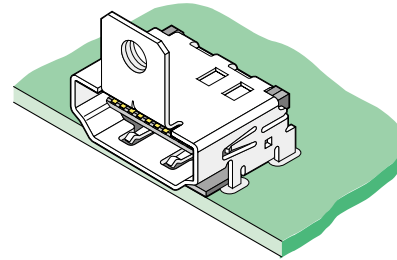

Flange Version

Order No.	Circuits	Packaging
500254-1907	19	Embossed Tape

Order No.	Circuits	Packaging
500254-1911	19	Tray

Cable Assemblies

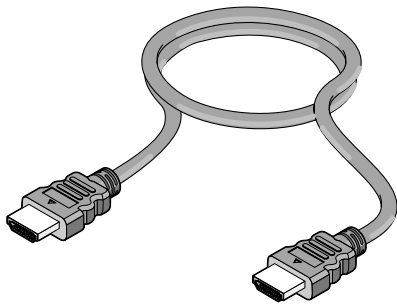

HDMI — HDMI

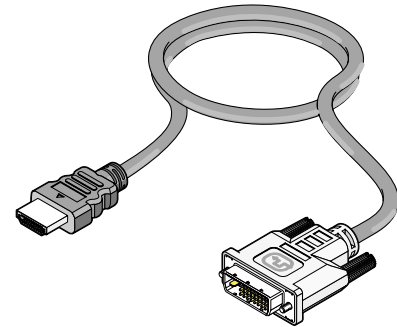

HDMI — DVI*

Order No.	Cable Length*	AWG	Outer Diameter	Cable Color
88768-9800	1 Meters	28 (TMDS)	7.30 (.287)	Black
88768-9810	2 Meters			
88768-9820	3 Meters			
88768-9830	5 Meters	30 (TMDS)	6.00 (.236)	
88768-9900	1 Meters			
88768-9910	2 Meters			
88768-9920	3 Meters			

Order No.	Cable Length*	AWG	Outer Diameter	Cable Color
88768-3500	1 Meters	28 (TMDS)	7.30 (.287)	Black
88768-3510	2 Meters			
88768-3520	3 Meters			
88768-3530	5 Meters	30 (TMDS)	5.50 (.217)	
88768-3600	1 Meters			
88768-3610	2 Meters			
88768-3620	3 Meters			
88768-3630	5 Meters			

* For custom cable lengths contact Molex

* Provides backward compatibility to DVI; for custom cable lengths contact Molex

See www.molex.com for drawings and details



Bringing People & Technology Together, WorldwideSM

Americas Headquarters
 2222 Wellington Ct.
 Lisle, Illinois 60532 USA
 Tel: 1-800-78MOLEX
 amerinfo@molex.com

Far East North Headquarters
 Yamato, Kanagawa, Japan
 Tel: 81-462-65-2324
 feninfo@molex.com

Far East South Headquarters
 Jurong, Singapore
 Tel: 65-6-268-6868
 fesinfo@molex.com

European Headquarters
 Munich, Germany
 Tel: 49-89-413092-0
 eurinfo@molex.com

Corporate Headquarters
 2222 Wellington Ct.
 Lisle, Illinois 60532 USA
 Tel: 630-969-4550

Visit our website at www.molex.com