

XPT IGBT

Copack

$I_{C25} = 20 \text{ A}$
 $V_{CES} = 1200 \text{ V}$
 $V_{CE(sat)typ} = 1.8 \text{ V}$

Part number

IXA12IF1200HB

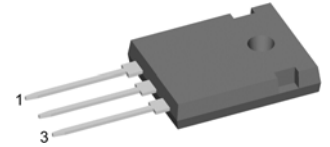
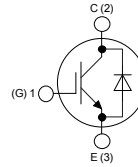

Features / Advantages:

- Easy paralleling due to the positive temperature coefficient of the on-state voltage
- Rugged XPT design (Xtreme light Punch Through) results in:
 - short circuit rated for 10 μsec .
 - very low gate charge
 - low EMI
 - square RBSOA @ 3x I_c
- Thin wafer technology combined with the XPT design results in a competitive low $V_{CE(sat)}$
- SONIC™ diode
 - fast and soft reverse recovery
 - low operating forward voltage

Applications:

- AC motor drives
- Solar inverter
- Medical equipment
- Uninterruptible power supply
- Air-conditioning systems
- Welding equipment
- Switched-mode and resonant-mode power supplies
- Inductive heating, cookers

Package:

- Housing: TO-247
- Industry standard outline
- Epoxy meets UL 94V-0
- RoHS compliant

IGBT

Symbol	Definition	Conditions	Ratings			Unit
			min.	typ.	max.	
V_{CES}	Collector emitter voltage	$V_{GE} = 0 \text{ V}$			1200	V
V_{GES}	Maximum DC gate voltage				± 20	V
I_{C25}	Collector current				20	A
I_{C100}					13	A
P_{tot}	Total power dissipation				85	W
I_{CES}	Collector emitter leakage current	$V_{CE} = V_{CES} ; V_{GE} = 0 \text{ V}$			0.1	mA
				0.1		mA
I_{GES}	Gate emitter leakage current	$V_{CE} = 0 \text{ V}; V_{GE} = \pm 20 \text{ V}$			500	nA
$V_{CE(sat)}$	Collector emitter saturation voltage	$I_C = 9 \text{ A}; V_{GE} = 15 \text{ V}$		1.8	2.1	V
				2.1		V
$V_{GE(th)}$	Gate emitter threshold voltage	$I_C = 0.3 \text{ mA}; V_{GE} = V_{CE}$	5.4	6	6.5	V
Q_{on}	Total gate charge	$V_{CE} = 600 \text{ V}; V_{GE} = 15 \text{ V}; I_C = 10 \text{ A}$		27		nC
$t_{d(on)}$	Turn-on delay time			70		ns
t_r	Current rise time			40		ns
$t_{d(off)}$	Turn-off delay time	Inductive load		250		ns
t_f	Current fall time	$V_{CE} = 600 \text{ V}; I_C = 10 \text{ A}$		100		ns
E_{on}	Turn-on energy per pulse	$V_{GE} = \pm 15 \text{ V}; R_G = 100 \Omega$	$T_{VJ} = 125^\circ\text{C}$	1.1		mJ
E_{off}	Turn-off energy per pulse			1.1		mJ
RBSOA	Reverse bias safe operation area	$V_{GE} = 15 \text{ V}; R_G = 100 \Omega$ $V_{CEK} = 1200 \text{ V}$	$T_{VJ} = 125^\circ\text{C}$		30	A
SCSOA	Short circuit safe operation area					
t_{sc}	Short circuit duration	$V_{CE} = 900 \text{ V}; V_{GE} = \pm 15 \text{ V}$	$T_{VJ} = 125^\circ\text{C}$		10	μs
I_{sc}	Short circuit current	$R_G = 100 \Omega$; non-repetitive			40	A
R_{thJC}	Thermal resistance junction to case				1.5	K/W

Diode

Symbol	Definition	Conditions	Ratings			Unit
			min.	typ.	max.	
I_{F25}	Forward current	$T_C = 25^\circ\text{C}$			22	A
I_{F100}		$T_C = 100^\circ\text{C}$			14	A
V_F	Forward voltage	$I_F = 10\text{ A}$	$T_{VJ} = 25^\circ\text{C}$	1.95	2.2	V
			$T_{VJ} = 125^\circ\text{C}$	1.95		V
Q_{rr}	Reverse recovery charge	$V_R = 600\text{ V}$		1.3		μC
I_{RM}	Maximum reverse recovery current	$di_F/dt = - 250\text{ A}/\mu\text{s};$	$T_{VJ} = 125^\circ\text{C}$	10.5		A
t_{rr}	Reverse recovery time	$I_F = 10\text{ A}$		350		ns
$E_{rec(off)}$	Reverse recovery losses at turn-off			0.35		mJ
R_{thJC}	Thermal resistance junction to case				1.8	K/W

Equivalent Circuits for Simulation

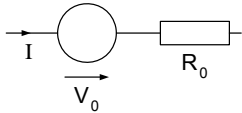

Symbol	Definition		Ratings			Unit
			min.	typ.	max.	
V_0	IGBT	$T_{VJ} = 150^\circ\text{C}$			1.1	V
R_0					153	m Ω
V_0	Diode	$T_{VJ} = 150^\circ\text{C}$			1.25	V
R_0					85	m Ω

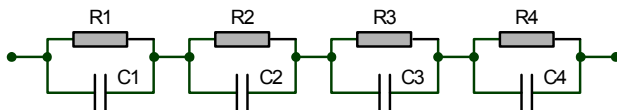

$$Z_{th}(t) = \sum_{i=1}^n \left[R_i \cdot \left(1 - \exp\left(-\frac{t}{\tau_i}\right) \right) \right]$$

$$\tau_i = R_i \cdot C_i$$

	IGBT	Diode
R_1	tbd	tbd
R_2	tbd	tbd
R_3	tbd	tbd
R_4	tbd	tbd
τ_1	tbd	tbd
τ_2	tbd	tbd
τ_3	tbd	tbd
τ_4	tbd	tbd

Package TO-247

Symbol	Definition	Conditions	Ratings			Unit
			min.	typ.	max.	
T_{vj}	Virtual junction temperature		-55		150	°C
T_{stg}	Storage temperature		-55		150	°C
R_{thCH}	Thermal resistance case to heatsink			0.25		K/W
Weight				6		g
M_D	Mounting torque		0.8		1.2	Nm
F_C	Mounting force with clip		20		120	N

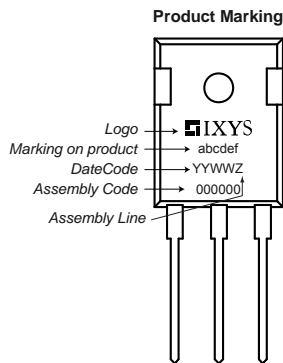
Part number

I = IGBT
 X = XPT IGBT
 A = Gen 1 / std
 12 = Current Rating [A]
 IF = Copack
 1200 = Reverse Voltage [V]
 HB = TO-247AD (3)

Ordering	Part Name	Marking on Product	Delivering Mode	Base Qty	Code Key
Standard	IXA 12 IF 1200 HB	IXA12IF1200HB	Tube	30	508453

Similar Part	Package	Voltage class
IXA12IF1200PB	TO-220AB (3)	1200
IXA12IF1200PC	TO-263AB (D2Pak)	1200
IXA12IF1200TC	TO-268AA (D3Pak)	1200

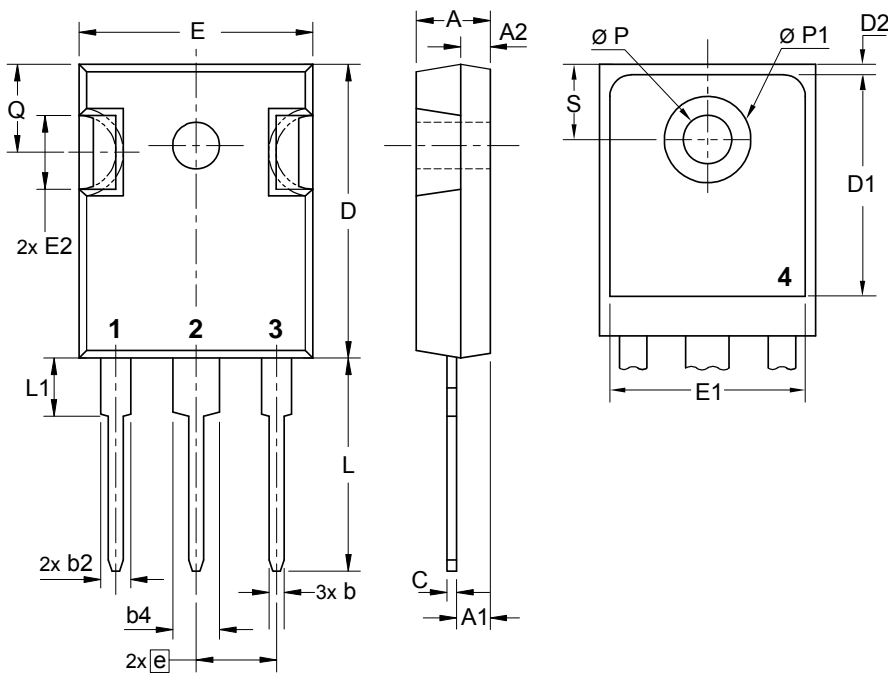

Sym.	Inches		Millimeter	
	min.	max.	min.	max.
A	0.185	0.209	4.70	5.30
A1	0.087	0.102	2.21	2.59
A2	0.059	0.098	1.50	2.49
D	0.819	0.845	20.79	21.45
E	0.610	0.640	15.48	16.24
E2	0.170	0.216	4.31	5.48
e	0.215 BSC		5.46 BSC	
L	0.780	0.800	19.80	20.30
L1	-	0.177	-	4.49
Ø P	0.140	0.144	3.55	3.65
Q	0.212	0.244	5.38	6.19
S	0.242 BSC		6.14 BSC	
b	0.039	0.055	0.99	1.40
b2	0.065	0.094	1.65	2.39
b4	0.102	0.135	2.59	3.43
c	0.015	0.035	0.38	0.89
D1	0.515	-	13.07	-
D2	0.020	0.053	0.51	1.35
E1	0.530	-	13.45	-
Ø P1	-	0.29	-	7.39

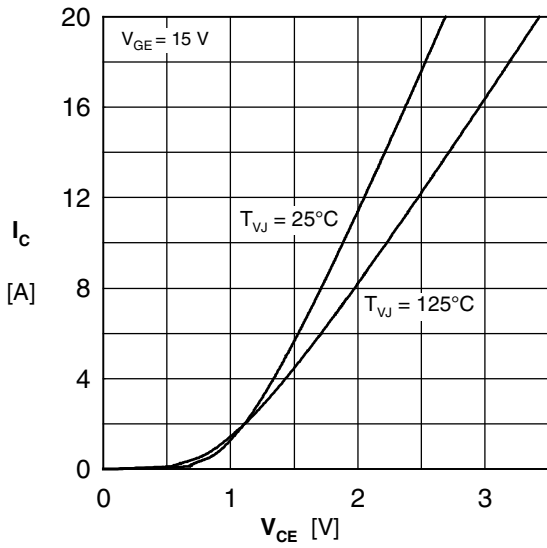

Fig. 1 Typ. output characteristics

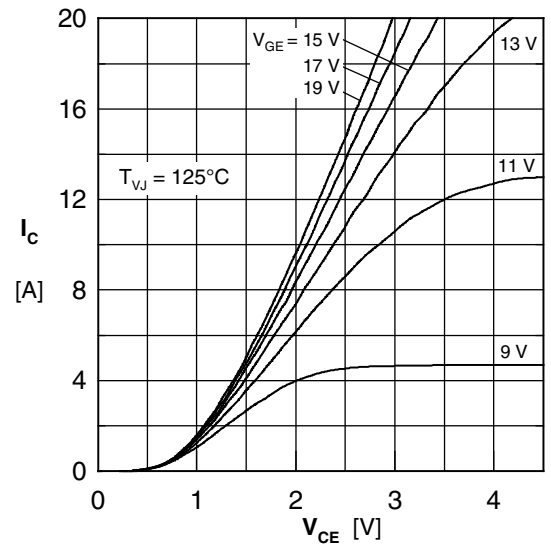

Fig. 2 Typ. output characteristics

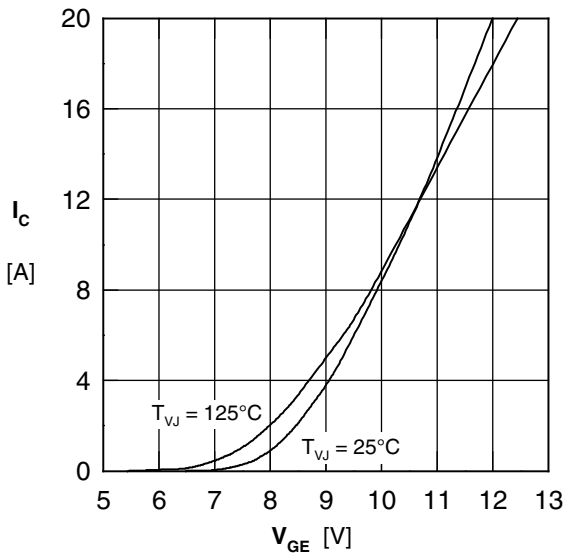

Fig. 3 Typ. transfer characteristics

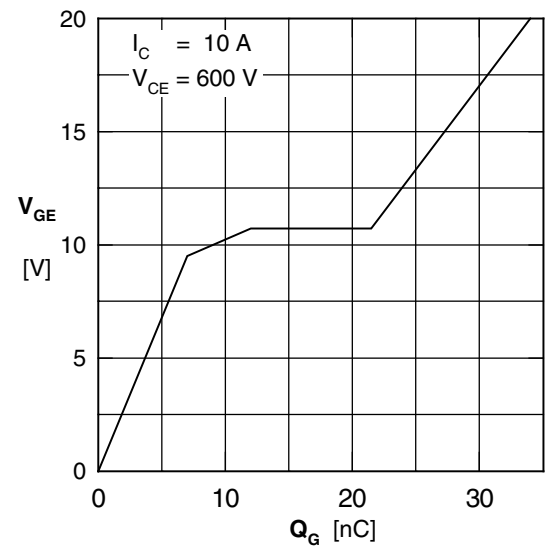

Fig. 4 Typ. turn-on gate charge

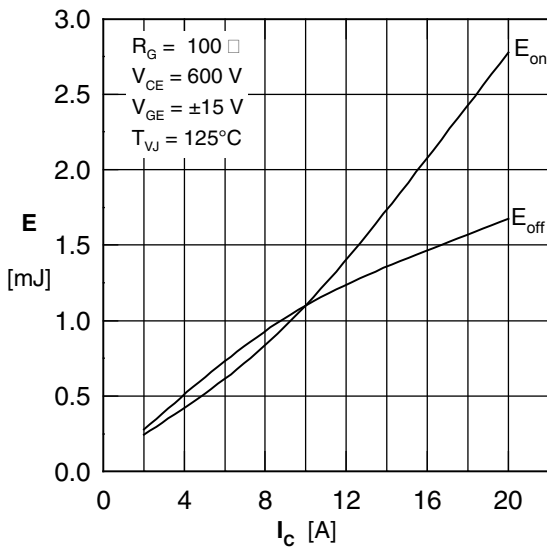

Fig. 5 Typ. switching energy vs. collector current

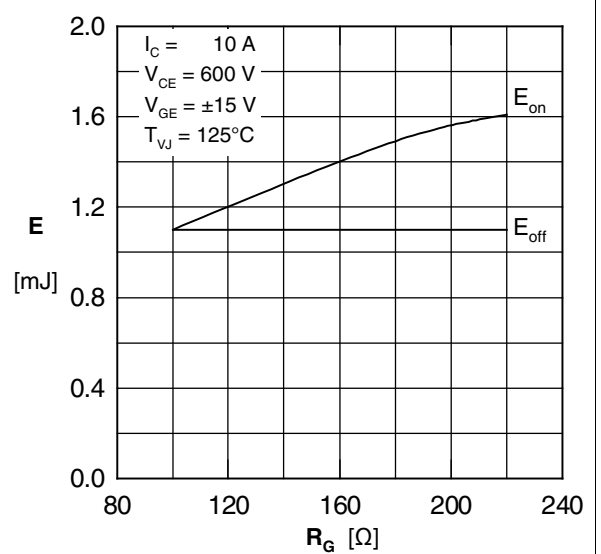

Fig. 6 Typ. switching energy vs. gate resistance

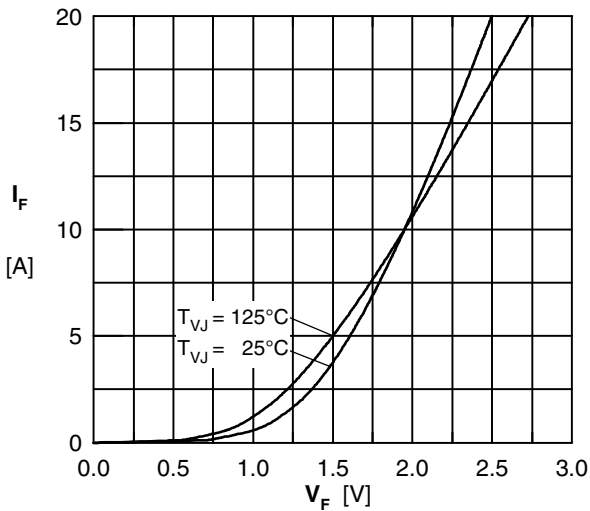

Fig. 7 Typ. forward characteristics

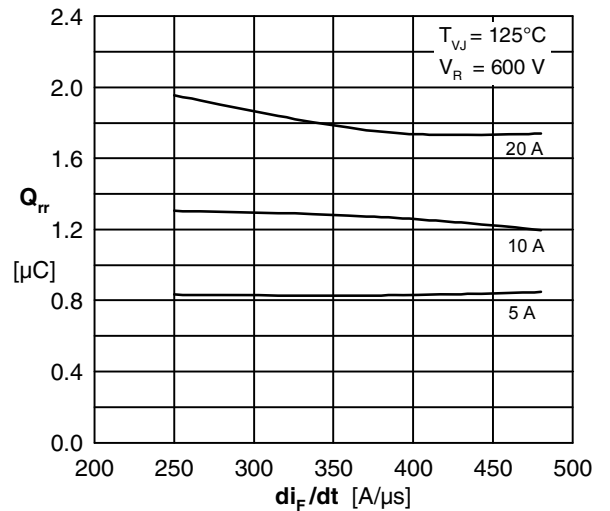

Fig. 8 Typical reverse recovery charge Q_{rr} versus di_F/dt (125°C)

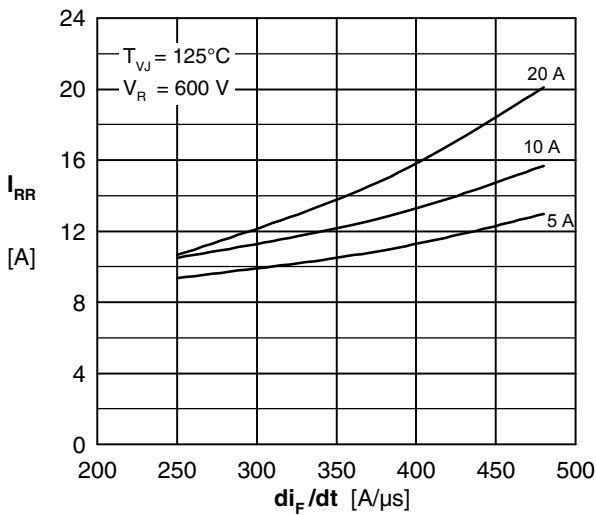

Fig. 9 Typical peak reverse current I_{RR} versus di_F/dt (125°C)

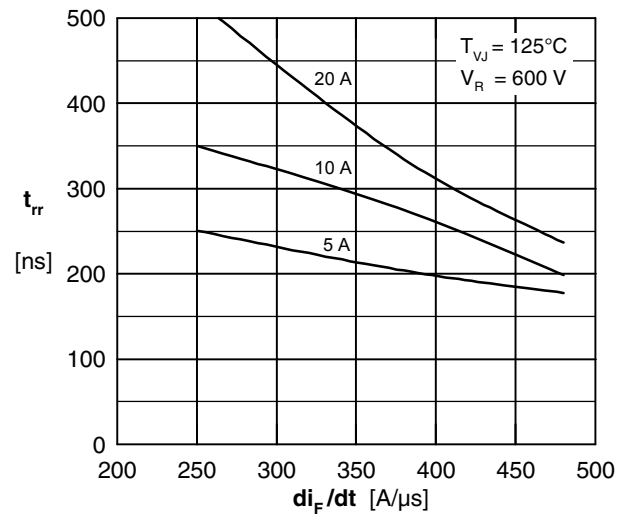

Fig. 10 Typ. recovery time t_{rr} vs. di/dt (125°C)

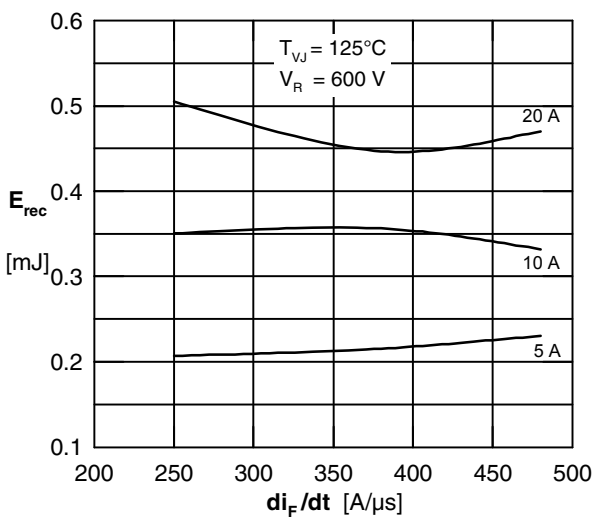

Fig. 11 Typ. recovery energy E_{rec} vs. di_F/dt (125°C)