

Delivery address: Mackenrodtstraße 14,
36039 Fulda, Germany
Postal address: 36035 Fulda, Germany
Phone: +49 661 6003-0
Fax: +49 661 6003-607
E-mail: mail@jumo.net
Internet: www.jumo.net

JUMO House
Temple Bank, Riverway
Harlow, Essex CM 20 2TT, UK
Phone: +44 1279 635533
Fax: +44 1279 635262
E-mail: sales@jumo.co.uk
Internet: www.jumo.co.uk

885 Fox Chase, Suite 103
Coatesville PA 19320, USA
Phone: 610-380-8002
1-800-554-JUMO
Fax: 610-380-8009
E-mail: info@JumoUSA.com
Internet: www.JumoUSA.com



JUMO VIBROtemp

Screw-in resistance thermometers with plug connector

- for temperatures from -50 to +300°C
- highly resistant to shock and vibration
- connector locked in for reliable contact, IP65 or IP69K protection
- available with transmitter

Shockproof screw-in resistance thermometers enable temperature measurement under pressure in motors, compressors, plant engineering and in ship building.

The connection between the protection fitting and the connecting cable incorporates a locking system and has IP65 or IP69K protection rating when assembled.

The measuring insert is normally fitted with a Pt100 temperature sensor to EN 60 751, Class B in 2-wire circuit. Versions with Pt500 or Pt1000 as well as semiconductor or NTC temperature sensors (only on Types 902004/10 and .../15) can also be supplied. With Types 902004/20 and .../21, there is a choice between 2-wire and 4-wire circuit connections. Types 902004/25 to .../29 are available with transmitter (output 4 – 20mA).

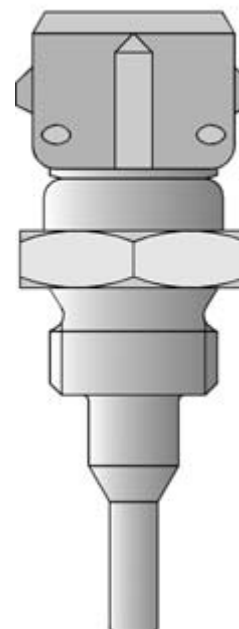

Technical data

Connection

Type 902004/10 plug connector with gold-plated contacts, IP65 when assembled
Type 902004/15 connector DIN 72 585, IP69K when assembled
Types 902004/20, ... /25 and .../28, connector EN 175301-803, Pg9
Types 902004/21, ... /26 and .../29, connector EN 175301-803, Pg11
max. conductor cross-section 1.5mm², IP65, ambient temperature -40 to +125°C,
version with transmitter: ambient temperature -40 to +85°C

Process connection

thread, stainless steel 1.4301 / 1.4571

Protection tube

stainless steel 1.4301, 6mm and 7.5mm dia. stepped down to 4mm
brass 2.0401, 7.5mm dia. stepped down to 4mm
stainless steel 1.4571, 8mm and 6mm dia. stepped down to 3.3mm,
pressure loading 50bar max. at 200°C (Types 902004/20 and .../21)

Measuring insert

Pt100 temperature sensor, EN 60 751, Class B in 2-wire circuit
(replaceable on Types 902004/20 and .../21)*

Protection

IP65, IP69K when assembled (Type 902004/15)

Response times

Type 902004/10:	$t_{0.5} = 1.2 \text{ sec}$, $t_{0.9} = 6 \text{ sec}$, in water with 0.2m/sec, 4mm dia.
Type 902004/15:	$t_{0.5} = 1.2 \text{ sec}$, $t_{0.9} = 6 \text{ sec}$, in water with 0.2m/sec, 4mm dia.
Types 902004/20 and .../21:	$t_{0.5} = 15 \text{ sec}$, $t_{0.9} = 45 \text{ sec}$, in water with 0.2m/sec, 8mm dia.
	$t_{0.5} = 23 \text{ sec}$, $t_{0.9} = 59 \text{ sec}$, in oil with 0.2m/sec, 8mm dia.
Types 902004/25 to .../29:	$t_{0.5} < 2 \text{ sec}$, $t_{0.9} < 4 \text{ sec}$, in water with 0.2m/sec, 6mm dia. stepped down to 3mm dia.

Vibration strength

Germanischer Lloyd Application Category D Characteristic 2

Approvals

Types 902004/20 and .../21 GL Germanischer Lloyd

Accessories

pockets, see Data Sheet 90.9721
mating plug for Type 902004/10 with or without siliconized connecting cable, 2.5m long, see Data Sheet 90.9726
mating plug for extra code 424 (machinery plug M 12x1) with PVC connecting cable, 2 m long

* With Types 902004/20 and .../21, short fitting lengths in conjunction with unfavorable installation conditions (heat conduction error) may result in the tolerance class being exceeded.

Delivery address: Mackenrodtstraße 14,
36039 Fulda, Germany
Postal address: 36035 Fulda, Germany
Phone: +49 661 6003-0
Fax: +49 661 6003-607
E-mail: mail@jumo.net
Internet: www.jumo.net

JUMO House
Temple Bank, Riverway
Harlow, Essex CM 20 2TT, UK
Phone: +44 1279 635533
Fax: +44 1279 635262
E-mail: sales@jumo.co.uk
Internet: www.jumo.co.uk

885 Fox Chase, Suite 103
Coatesville PA 19320, USA
Phone: 610-380-8002
1-800-554-JUMO
Fax: 610-380-8009
E-mail: info@JumoUSA.com
Internet: www.JumoUSA.com



Transmitter	Input	
	Measurement input	Pt100 (EN 60 751)
	Measurement range limits	-50 to +260°C
	Measurement span	25 to 310°C
	Sensor current	≤ 0.5mA
	Sampling rate	continuous measurement because of analog signal path
	Measurement circuit monitoring	
	Underrange	falling to ≤ 3.6mA
	Overrange	rising to ≥ 22mA to < 28mA (24mA typical)
	Probe short circuit	≤ 3.6mA
	Probe and lead break	positive: ≥ 22mA to < 28mA (24mA typical)
	Output	
	Output signal	proportional DC current 4 – 20mA
	Transfer characteristic	linear with temperature
	Transfer accuracy	≤ ±0.1%
	Damping of ripple on 24V supply, amplitude 10V/50Hz, burden 470Ω/load 10MΩ	40dB
	Burden (R _b)	$R_b = (U_b - 7.5V) / 22mA$
	Burden error	≤ ±0.02% / 100Ω ¹
	Settling time on temperature change	≤ 10msec
	Calibration conditions	24V DC / approx. 22°C
	Calibration accuracy	≤ ±0.2% ^{1,2} or ≤ ±0.2°C
	Overall accuracy: sensor/calibration	±0.4°C (typical) at 20°C / 24V DC supply voltage
	Supply	
	Supply voltage (U _b)	7.5 – 30V DC
	Reverse polarity protection	yes
	Supply voltage error	≤ ±0.01% per V deviation from 24V ¹
	Ambient conditions	
	Operating temperature range	-40 to +85°C
	Storage temperature range	-40 to +100°C
	Temperature error	≤ ±0.01% per °C deviation from 22°C ¹
	Climatic conditions similar to EN 60 654 Class D1	relative humidity ≤ 95% annual mean, no condensation
	EMC interference emission/immunity	EN 61 326 Class B / to industrial requirements

1. All data refer to the end-of-range value 20mA.
2. The larger value applies.

Connection example with supply unit

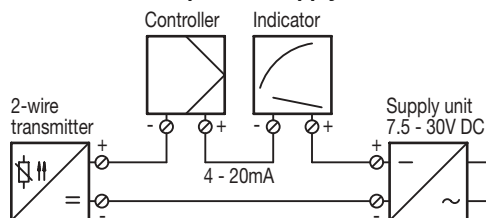

Connection diagram

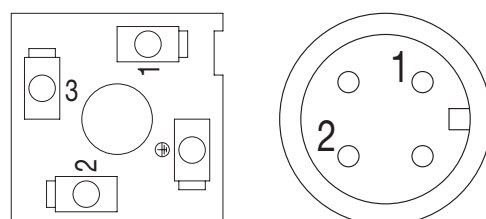

Connection for		Terminal assignment							
	Supply 7.5 – 30V DC	+ 1	$R_B = \frac{U_b - 7.5V}{22mA}$						
	Current output 4 – 20mA	- 2	$R_B = \text{burden resistance}$ $U_b = \text{supply voltage}$						
			<table border="0"> <tr> <td style="text-align: center;">1</td> <td style="text-align: center;">2</td> </tr> <tr> <td style="text-align: center;"> </td> <td style="text-align: center;"> </td> </tr> <tr> <td style="text-align: center;">+</td> <td style="text-align: center;">-</td> </tr> </table>	1	2			+	-
1	2								
+	-								



Dimensions

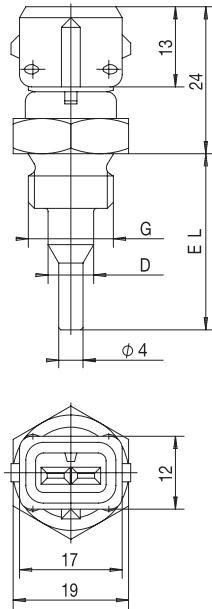

Type 902004/10

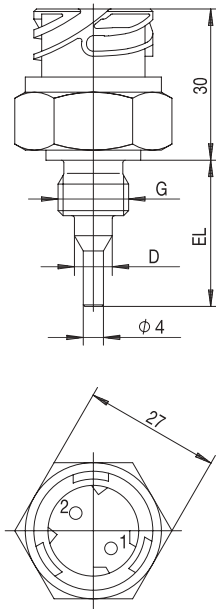

Type 902004/15

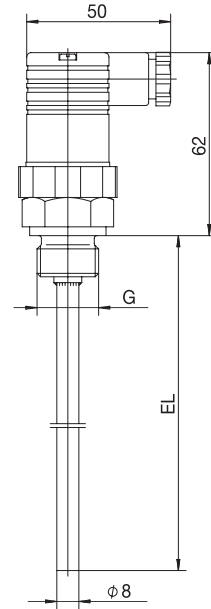

Type 902004/20
Type 902004/21

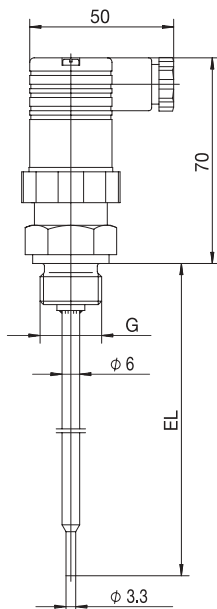

Type 902004/25
Type 902004/26

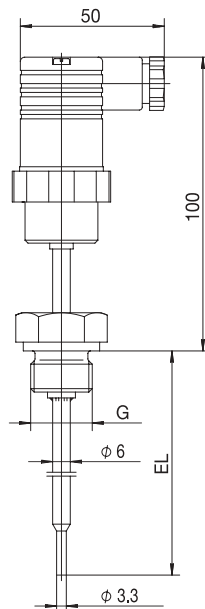

Type 902004/28
Type 902004/29

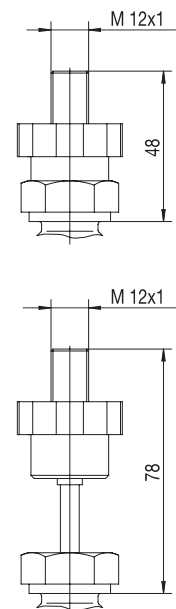

with extra code 424

Delivery address: Mackenrodtstraße 14,
36039 Fulda, Germany
Postal address: 36035 Fulda, Germany
Phone: +49 661 6003-0
Fax: +49 661 6003-607
E-mail: mail@jumo.net
Internet: www.jumo.net

JUMO House
Temple Bank, Riverway
Harlow, Essex CM 20 2TT, UK
Phone: +44 1279 635533
Fax: +44 1279 635262
E-mail: sales@jumo.co.uk
Internet: www.jumo.co.uk

885 Fox Chase, Suite 103
Coatesville PA 19320, USA
Phone: 610-380-8002
1-800-554-JUMO
Fax: 610-380-8009
E-mail: info@JumoUSA.com
Internet: www.JumoUSA.com



Order details: Screw-in resistance thermometers with plug connector

(1) Basic version

902004/10 Screw-in resistance thermometer with plug connector

902004/15 Screw-in resistance thermometer with connector DIN 72 585

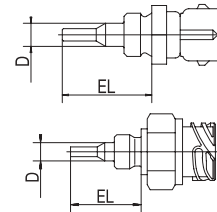

(2) Operating temperature in °C

x 384 -50 to +240°C
x 390 -50 to +300°C

(3) Measuring insert

x x 1003 1 x Pt100 in 2-wire circuit
x x 1004 1 x Pt500 in 2-wire circuit
x x 1005 1 x Pt1000 in 2-wire circuit
x x 1601 1 x KTY 11-6 in 2-wire circuit

(4) Tolerance class to EN 60 751

x x 0 KTY temperature sensor
x x 1 Class B (standard)
x x 2 Class A

(5) Protection tube diameter D in mm

x x 6 6mm with EL = 60mm
x x 7,5 7.5mm stepped down to 4mm with EL = 29mm

(6) Fitting length EL in mm

x x 29 29mm
x x 60 60mm

(7) Process connection

x x 103 G 3/8 thread
x x 121 M 14x1.5 thread
x x 141 1/8-27NPT thread
x x 542 R 3/8 DIN 2999 thread
x x 543 R 1/2 DIN 2999 thread, only with EL = 60mm

(8) Protection tube material

x x 21 stainless steel 1.4301
x x 50 brass 2.0401

Order code	(1)	(2)	(3)	(4)	(5)	(6)	(7)	(8)
Order example	902004/10	- 390	- 1003	- 1	- 6	- 29	- 103	- 21

Delivery address: Mackenrodtstraße 14,
36039 Fulda, Germany
Postal address: 36035 Fulda, Germany
Phone: +49 661 6003-0
Fax: +49 661 6003-607
E-mail: mail@jumo.net
Internet: www.jumo.net

JUMO House
Temple Bank, Riverway
Harlow, Essex CM 20 2TT, UK
Phone: +44 1279 635533
Fax: +44 1279 635262
E-mail: sales@jumo.co.uk
Internet: www.jumo.co.uk

885 Fox Chase, Suite 103
Coatesville PA 19320, USA
Phone: 610-380-8002
1-800-554-JUMO
Fax: 610-380-8009
E-mail: info@JumoUSA.com
Internet: www.JumoUSA.com



Order details: Screw-in resistance thermometers with plug connector

(1) Basic version

	902004/20	Screw-in resistance thermometer with terminal box, Pg9, to EN 175301-803 (DIN 43 650)
	902004/21	Screw-in resistance thermometer with terminal box, Pg11, to EN 175301-803 (DIN 43 650)
		(2) Operating temperature in °C
x	x	380 -50 to +200°C
		(3) Measuring insert
x	x	1003 1 x Pt100 in 2-wire circuit
x	x	1011 1 x Pt100 in 4-wire circuit
x	x	2003 2 x Pt100 in 2-wire circuit
		(4) Tolerance class to EN 60 751
x	x	1 Class B (standard)
x	x	2 Class A
		(5) Protection tube diameter D in mm
x	x	8 8mm
		(6) Fitting length EL in mm (50 ≤ EL ≤ 250)
x	x	50 50mm
x	x	100 100mm
x	x	150 150mm
x	x	200 200mm
x	x	250 250mm (without GL approval)
x	x	... please specify in plain text (in 50mm steps)
		(7) Process connection
x	x	102 G 1/4 thread
x	x	103 G 3/8 thread
x	x	104 G 1/2 thread
x	x	126 M 18x1.5 thread
x	x	128 M 20x1.5 thread
x	x	144 1/2-14NPT thread
		(8) Protection tube material
x	x	26 stainless steel 1.4571
		(9) Extra code
x	x	000 no extra code
x	x	062 GL approval (max. fitting length EL = 200mm)
x	x	424 machinery plug M 12x1

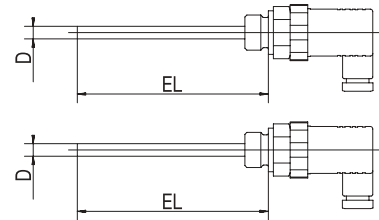

Order code	(1)	(2)	(3)	(4)	(5)	(6)	(7)	(8)	(9)	,...
Order example	902004/20	- 380	- 1003	- 1	- 8	- 50	- 102	- 26	/ 000 ¹	

1. List extra codes in sequence, separated by commas.

Delivery address: Mackenrodtstraße 14,
36039 Fulda, Germany
Postal address: 36035 Fulda, Germany
Phone: +49 661 6003-0
Fax: +49 661 6003-607
E-mail: mail@jumo.net
Internet: www.jumo.net

JUMO House
Temple Bank, Riverway
Harlow, Essex CM 20 2TT, UK
Phone: +44 1279 635533
Fax: +44 1279 635262
E-mail: sales@jumo.co.uk
Internet: www.jumo.co.uk

885 Fox Chase, Suite 103
Coatesville PA 19320, USA
Phone: 610-380-8002
1-800-554-JUMO
Fax: 610-380-8009
E-mail: info@JumoUSA.com
Internet: www.JumoUSA.com



Order details: Screw-in resistance thermometers with plug connector

(1) Basic version

902004/25	Screw-in resistance thermometer with transmitter and terminal box, Pg9 to EN 175301-803 (DIN 43 650)
902004/26	Screw-in resistance thermometer with transmitter and terminal box, Pg11 to EN 175301-803 (DIN 43 650)
902004/28	Screw-in resistance thermometer with transmitter and terminal box, Pg9 to EN 175301-803 (DIN 43 650), version with extension for elevated temperatures
902004/29	Screw-in resistance thermometer with transmitter and terminal box, Pg11 to EN 175301-803 (DIN 43 650), version with extension for elevated temperatures

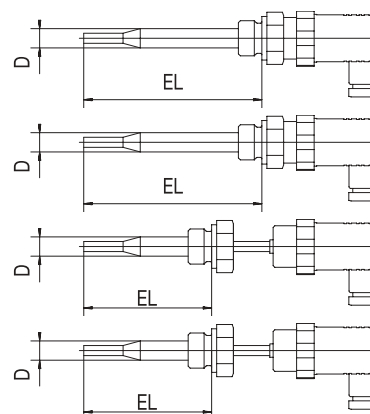

(2) Operating temperature in °C

x	x		370	-50 to +150°C
		x	386	-50 to +260°C
(3) Measuring insert				
x	x	x	1003	1 x Pt100 in 2-wire circuit
(4) Tolerance class to EN 60 751				
x	x	x	1	Class B (standard)
x	x	x	2	Class A
(5) Protection tube diameter D in mm				
x	x	x	6	6mm stepped down to 3.3mm
(6) Fitting length EL in mm (50 ≤ EL ≤ 250)				
x	x	x	50	50mm
x	x	x	100	100mm
x	x	x	150	150mm
x	x	x	200	200mm
x	x	x	250	250mm
x	x	x	...	please specify in plain text (in 50mm steps)

(7) Process connection

x	x	x	102	G 1/4 thread
x	x	x	103	G 3/8 thread
x	x	x	104	G 1/2 thread
x	x	x	126	M 18x1.5 thread
x	x	x	128	M 20x1.5 thread
x	x	x	144	1/2-14NPT thread

(8) Protection tube material

x	x	x	26	stainless steel 1.4571
---	---	---	----	------------------------

(9) Extra code

x	x	x	000	no extra code
x	x	x	424	machinery plug M 12x1

Order code	(1)	(2)	(3)	(4)	(5)	(6)	(7)	(8)	(9)							
Order example	902004/25	-	370	-	1003	-	1	-	6	-	50	-	102	-	26	/	000

Delivery address: Mackenrodtstraße 14,
36039 Fulda, Germany
Postal address: 36035 Fulda, Germany
Phone: +49 661 6003-0
Fax: +49 661 6003-607
E-mail: mail@jumo.net
Internet: www.jumo.net

JUMO House
Temple Bank, Riverway
Harlow, Essex CM 20 2TT, UK
Phone: +44 1279 635533
Fax: +44 1279 635262
E-mail: sales@jumo.co.uk
Internet: www.jumo.co.uk

885 Fox Chase, Suite 103
Coatesville PA 19320, USA
Phone: 610-380-8002
1-800-554-JUMO
Fax: 610-380-8009
E-mail: info@JumoUSA.com
Internet: www.JumoUSA.com



Stock versions:

(1)	(2)	(3)	(4)	(5)	(6)	(7)	(8)	Sales No.
902004/10	390	1003	1	7,5	29	121	21	90/00089616
902004/10	390	1003	1	7,5	29	121	50	90/00089617

Stock versions:

(1)	(2)	(3)	(4)	(5)	(6)	(7)	(8)	(9)	Sales No.
902004/20	380	1003	1	8	50	104	26	000	90/00365259
902004/20	380	1003	1	8	100	104	26	000	90/00368414
902004/20	380	1003	1	8	150	104	26	000	90/00368416

Accessory

Mating plug for Type 902004/10 with siliconized connecting cable, 2.5m long	Sales No.
Mating plug for extra code 424 (machinery plug M 12x1) with PVC connecting cable, 2m long	90/00308880
	90/00404585