

FEATURES	APPLICATIONS
<ul style="list-style-type: none"> <li>■ Wide Frequency Range</li> <li>■ Additional EMI Protection</li> <li>■ Custom Manufacturing Capability</li> <li>■ Fast Turnaround Options</li> </ul>	<ul style="list-style-type: none"> <li>■ Microprocessor Systems</li> <li>■ Datacommunications</li> <li>■ Consumer Electronics</li> <li>■ Automotive Electronics</li> </ul>

STANDARD SPECIFICATION	
Frequency Range:	300 kHz to 225 MHz
Adjustment Tolerance at 25°C:	± 30PPM Max.
Frequency Stability:	± 50PPM Max.
Operating Temperature Range:	-10°C to +60°C
Load Capacity:	30pF
E.S.R.:	See Table
Drive level:	500 MicroWatt
Ageing:	± 5PPM 1st Year Max.

Frequency Range	E.S.R
300kHz ~ 800 kHz	3000 Ω
800kHz ~ 1.3 MHz	5000 Ω
1.8 MHz ~ 2.0 MHz	800 Ω
2.0MHz ~ 2.4 MHz	300 Ω
2.4MHz ~ 3.0 MHz	250 Ω
3.0MHz ~ 3.2 MHz	120 Ω
3.2MHz ~ 4.0 MHz	90 Ω
4.0MHz ~ 4.2 MHz	100 Ω
4.2MHz ~ 6.0 MHz	50 Ω
6.0MHz ~ 8.0 MHz	40 Ω
8.0MHz ~ 36 MHz	25 Ω
36MHz ~ 64 MHz	40 Ω
64MHz ~ 125 MHz	80 Ω
125MHz ~ 200 MHz	140 Ω

AVAILABLE OPTIONS	
Frequency Range:	300 kHz ~ 225 MHz
Adjustment Tolerance	±5PPM ~ ± 100PPM
Load Capacity:	Series or 9pF ~ 50pF
Shunt Capacity (C0):	4.5pF ~ 7pF (Typ.)
Dynamic Capacity (C1):	18fF ~ 20fF (Typ.)

Frequency Stability vs Operating Temperature Range													
Operating Temperature Range	Temperature Stability												
-10 to +60 -20 to +70 -40 to +90 -55 to +105 -55 to +125	<table style="margin: auto;"> <tr> <td style="text-align: center;">+/-5PPM</td> <td style="text-align: center;">+/-10PPM</td> <td style="text-align: center;">+/-20PPM</td> <td style="text-align: center;">+/-30PPM</td> <td style="text-align: center;">+/-40PPM</td> <td style="text-align: center;">+/-50PPM</td> </tr> <tr> <td style="text-align: center;">■</td> <td style="text-align: center;">■</td> <td style="text-align: center;">■</td> <td style="text-align: center;">■</td> <td style="text-align: center;">■</td> <td style="text-align: center;">■</td> </tr> </table>	+/-5PPM	+/-10PPM	+/-20PPM	+/-30PPM	+/-40PPM	+/-50PPM	■	■	■	■	■	■
+/-5PPM	+/-10PPM	+/-20PPM	+/-30PPM	+/-40PPM	+/-50PPM								
■	■	■	■	■	■								

Value Added Services	
In addition, AEL Crystals Ltd are able to offer our customers the following value added services:-	
<ul style="list-style-type: none"> <li>■ Fitted Insulators</li> <li>■ Radial Taping</li> <li>■ Lead Pre-Forming</li> </ul>	<ul style="list-style-type: none"> <li>■ Lead Cropping</li> <li>■ Earth Lead</li> <li>■ Bar-Coding</li> </ul>

# Specify AEL

## UM-1 UM-5 & UM-4 Miniature Crystals

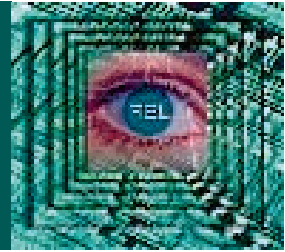

Quartz Crystal Resonators

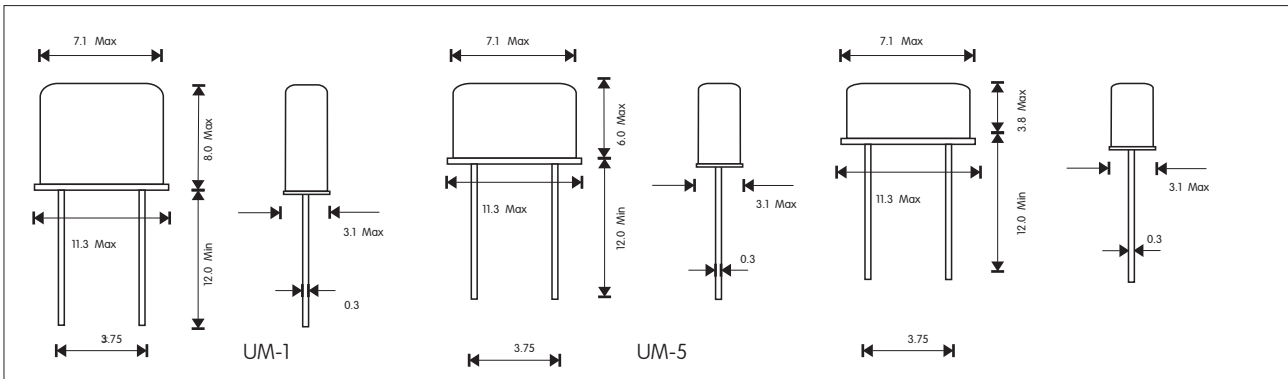

### FEATURES

- Small Size
- Wide Frequency Range
- High Stability
- Fast Turnaround Options

### APPLICATIONS

- Pagers
- Radio Communications
- Telemetry Systems
- Automotive Electronics

### STANDARD SPECIFICATION

Frequency Range: 4.00 MHz to 300.00 MHz\*

Adjustment Tolerance at 25°C: ± 30PPM Max.

Frequency Stability: ± 50PPM Max.

Operating Temperature Range: -10°C to +60°C

Load Capacity: 30pF

E.S.R.: See Table

Drive level: 100 MicroWatt

Ageing: ± 3PPM 1st Year Max.  
(\*UM-4/UM-5 From 10MHz)

Frequency Range	E.S.R	Mode
4.00 MHz ~ 4.99 MHz	200	Ω Fund
5.00 MHz ~ 5.99 MHz	150	Ω Fund
6.00 MHz ~ 6.99 MHz	120	Ω Fund
7.00 MHz ~ 8.99 MHz	100	Ω Fund
8.00 MHz ~ 9.99 MHz	90	Ω Fund
10.00 MHz ~ 15.99 MHz	40	Ω Fund
16.00 MHz ~ 22.99 MHz	30	Ω Fund
23.00 MHz ~ 39.99 MHz	60	Ω 3 O/T
40.00 MHz ~ 100.00 MHz	60	Ω 3 O/T
50.00 MHz ~ 150.00 MHz	90	Ω 5 O/T
100.0 MHz ~ 300.00 MHz	150	Ω 7 O/T

### AVAILABLE OPTIONS

Frequency Range: 4.00MHz ~ 300 MHz

Adjustment Tolerance ± 5PPM ~ ± 30PPM

Load Capacity: Series or 9pF ~ 50pF

Shunt Capacity (C0): 4.5pF ~ 7pF (Typ.)  
18fF ~ 20fF (Typ.)

Also available with SMD Metal Clip (UM-1 & UM-5)

### Frequency Stability vs Operating Temperature Range

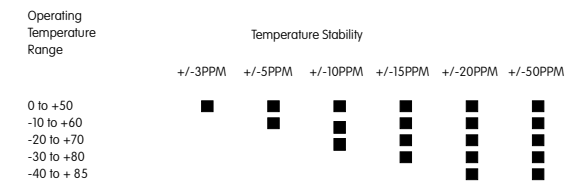

### Value Added Services

In addition, AEL Crystals Ltd are able to offer our customers the following value added services:-

- Fitted Insulators
- Radial Taping
- Lead Pre-Forming
- Lead Cropping
- Earth Lead
- Bar-Coding



quartz based frequency control components

Order Hotline +44 1293 524245

www.aelcrystals.co.uk  
sales@aelcrystals.co.uk

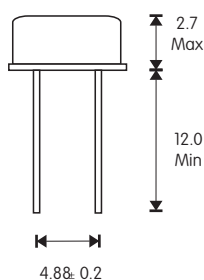

HC-49/SS

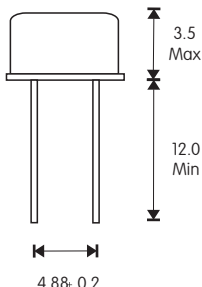

HC-49/S

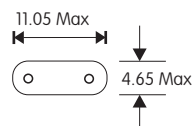

FEATURES	APPLICATIONS
<ul style="list-style-type: none"> <li>■ Standard Frequencies Ex-Stock</li> <li>■ Low Cost Solution</li> <li>■ Standard I.C Height</li> <li>■ Standard HC49U Base</li> </ul>	<ul style="list-style-type: none"> <li>■ Microprocessor Systems</li> <li>■ Datacommunications</li> <li>■ Consumer Electronics</li> <li>■ Automotive Electronics</li> </ul>

STANDARD SPECIFICATION
Frequency Range: 3.20 MHz to 70.00 MHz
Adjustment Tolerance at 25°C: ±30PPM Max.
Frequency Stability: ±50PPM Max.
Operating Temperature Range: -10°C to +60°C
Load Capacity: 30pF
E.S.R: See Table
Drive level: 100 MicroWatt
Ageing: ±5PPM 1st Year Max.

AVAILABLE OPTIONS
Frequency Range: 3.2 MHz ~ 70.0 MHz
Adjustment Tolerance: ±10PPM ~ ±100PPM
Load Capacity: Series or 9pF ~ 50pF
Shunt Capacity (C0): 4.5pF ~ 7pF (Typ.)
Dynamic Capacity (C1): 18fF ~ 20fF (Typ.)

Frequency Range	E.S.R
3.2 MHz ~ 3.49 MHz	200 Ω Fund
3.5 MHz ~ 3.99 MHz	140 Ω Fund
4.0 MHz ~ 4.39 MHz	120 Ω Fund
4.4 MHz ~ 4.89 MHz	100 Ω Fund
4.9 MHz ~ 5.99 MHz	80 Ω Fund
6.0 MHz ~ 6.99 MHz	60 Ω Fund
7.0 MHz ~ 7.99 MHz	50 Ω Fund
8.0 MHz ~ 10.99 MHz	45 Ω Fund
11.0 MHz ~ 11.99 MHz	40 Ω Fund
12.0 MHz ~ 14.99 MHz	35 Ω Fund
15.0 MHz ~ 36.00 MHz	30 Ω Fund
27.0 MHz ~ 70.00 MHz	100 Ω 3 O/T

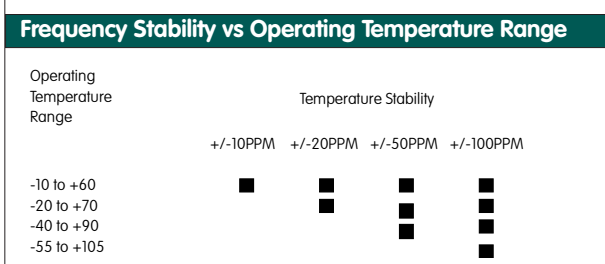

e e Service
In addition, AEL Crystals Ltd are able to offer our customers the following value added services:-
<ul style="list-style-type: none"> <li style="width: 50%;">■ Fitted Insulators</li> <li style="width: 50%;">■ Lead Cropping</li> <li style="width: 50%;">■ Radial Taping</li> <li style="width: 50%;">■ Earth Lead</li> <li style="width: 50%;">■ Lead Pre-Forming</li> <li style="width: 50%;">■ Bar-Coding</li> </ul>



Crystals Limited

quartz based frequency control components

Order Hotline +44 1293 524245

www.aelcrystals.co.uk  
sales@aelcrystals.co.uk

# Specify AEL

## 3x9mm AT-Cut Crystals

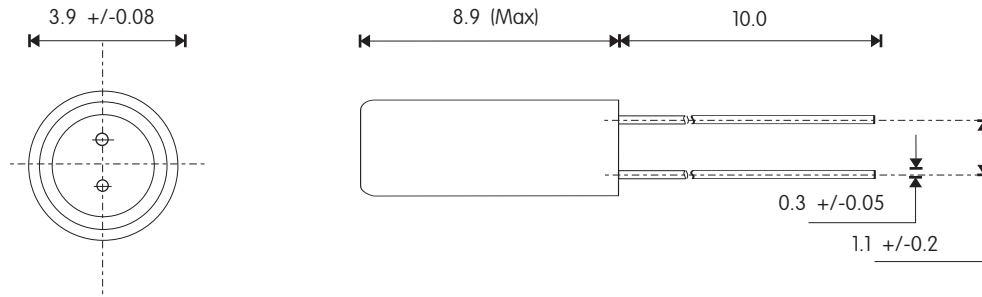
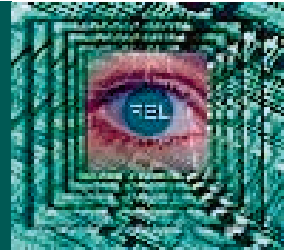

All Dims. in mm

Quartz Crystal Resonators

### FEATURES

- Small Size
- Wide Frequency Range
- High Shock Tolerance
- Good Frequency Stability

### APPLICATIONS

- Instrumentation
- Microprocessor Systems
- Process Control
- Automotive Electronics

### STANDARD SPECIFICATION

Frequency Range: 3.579 MHz to 70.00 MHz  
 Adjustment Tolerance at 25°C: ± 30PPM Max.  
 Frequency Stability: ± 50PPM Max.  
 Operating Temperature Range: -10°C to +60°C  
 Load Capacity: 30pF  
 E.S.R: See Table  
 Drive level: 100 MicroWatt  
 Ageing: ± 3PPM 1st Year Max.

Frequency Range	E.S.R	Mode
3.57 MHz	3.00 MHz	200 Ω Fund
4.00 MHz	4.49 MHz	150 Ω Fund
4.50 MHz	4.99 MHz	120 Ω Fund
5.00 MHz	5.99 MHz	100 Ω Fund
6.00 MHz	8.99 MHz	80 Ω Fund
9.00 MHz	9.99 MHz	60 Ω Fund
10.00 MHz	12.99 MHz	50 Ω Fund
13.00 MHz	18.99 MHz	35 Ω Fund
19.00 MHz	29.99 MHz	25 Ω Fund
30.00 MHz	33.00 MHz	20 Ω Fund
30.00 MHz	34.99 MHz	80 Ω 3 O/T
35.00 MHz	39.99 MHz	70 Ω 3 O/T
40.00 MHz	44.99 MHz	65 Ω 3 O/T
45.00 MHz	49.99 MHz	60 Ω 3 O/T
50.00 MHz	70.00 MHz	80 Ω 3 O/T

### AVAILABLE OPTIONS

Frequency Range: 3.57MHz ~ 70 MHz  
 Adjustment Tolerance: ± 10PPM ~ ± 30PPM  
 Load Capacity: Series or 9pF ~ 50pF  
 Shunt Capacity (C0): 4.5pF ~ 7pF (Typ.)  
 18fF ~ 20fF (Typ.)

#### Frequency Stability vs Operating Temperature Range

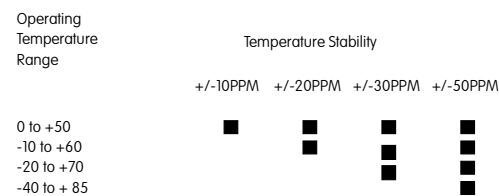

#### Value Added Services

In addition, AEL Crystals Ltd are able to offer our customers the following value added services:-

- Lead Cropping
- Bar-Coding
- Lead Pre-Forming



quartz based frequency control components

Order Hotline +44 1293 524245

www.aelcrystals.co.uk  
 sales@aelcrystals.co.uk

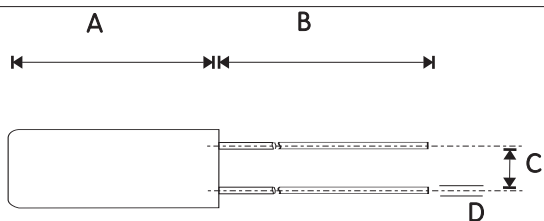

Package Style	A	B	C	D	E
3x8	8.2	9.0	1.10	0.35	3.10
2x6	6.2	9.0	0.70	0.26	2.10
1x5	5.1	4.0	0.45	0.15	1.50

### FEATURES

- Range of Sizes
- Low Cost
- High Shock Resistance
- Extensive UK Stocks

### APPLICATIONS

- Time Keeping
- Datacommunications
- Consumer Electronics
- Automotive Electronics

### STANDARD SPECIFICATION

Frequency Range: 32.768 kHz  
 Adjustment Tolerance at 25°C:  $\pm 20\text{PPM}$   
 Frequency Stability:  $-0.038\text{PPM}/^\circ\text{C}^2$   
 Operating Temperature Range:  $-10^\circ\text{C}$  to  $+60^\circ\text{C}$   
 Load Capacity: 12.5pF  
 E.S.R: 35 kOhm  
 Drive level: 1MicroWatt  
 Ageing:  $\pm 1\text{PPM}$  1st Year Typ.

#### Frequency Range

#### E.S.R

20.0 kHz	29.9 kHz	55k $\Omega$
30.0 kHz	39.9 kHz	45k $\Omega$
40.0 kHz	59.9 kHz	20k $\Omega$
60.0 kHz	69.9 kHz	15k $\Omega$
70.0 kHz	119.9 kHz	12k $\Omega$
120.0 kHz	164.9 kHz	10k $\Omega$
307.20 kHz		6k $\Omega$

### AVAILABLE OPTIONS

Frequency Range: 20 kHz to 165 kHz & 307.2kHz

Adjustment Tolerance  $\pm 20\text{PPM}$   $\pm 50\text{PPM}$   $\pm 100\text{PPM}$

Load Capacity: 6pF ~  $\infty$

Shunt Capacity (C0): 4.0pF Max

Also available from stock is a 32.768 kHz crystal specifically designed for the Dallas Semiconductor RTC

### Frequency Stability vs Operating Temperature Range

Tuning fork crystals exhibit a parabolic temperature coefficient with a response curve typically as shown

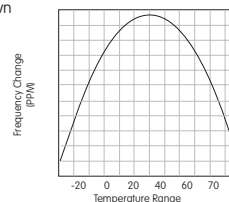

### Handling Note

Crystals utilising a tuning fork element should not be subjected to ultrasonic cleaning. This is because the blank can be damaged due to the frequency of the ultrasonic bath being in resonance with the crystal itself.



Crystals Limited

quartz based frequency control components

Order Hotline +44 1293 524245

www.aelcrystals.co.uk  
sales@aelcrystals.co.uk