

SECTION Z-Z

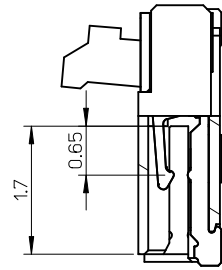

SECTION Y-Y

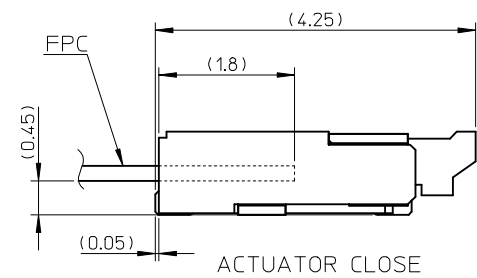
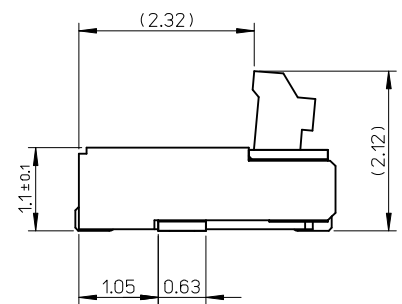

ACTUATOR CLOSE

15.6	15.8	14.4	15.0	17.2	501616-5185	501616-5150	51
13.8	14.0	12.6	13.2	15.4	501616-4585	501616-4550	45
12.6	12.8	11.4	12.0	14.2	501616-4185	501616-4150	41
12.0	12.2	10.8	11.4	13.6	501616-3985	501616-3950	39
10.8	11.0	9.6	10.2	12.4	501616-3585	501616-3550	35
E	D	(C)	(B)	A	EMBOSSED TAPE ORDER No.		MATERIAL NO. CIRCUIT

部品構成

- ハウジング・・・材質：耐熱性樹脂 黒色 UL94V-0
HOUSING MATERIAL :HEAT RESISTANT POLYMER BLACK UL94-V0
- 奇数ターミナル・・・材質：銅合金
ODD TERMINAL MATERIAL :COPPER ALLOY
処理：ニッケル下地部分金メッキ（接触部及びテール部）
FINISH :PARTLY GOLD(CONTACT,TAIL) OVER NICKEL PLATING
- 偶数ターミナル・・・材質：銅合金
EVEN TERMINAL MATERIAL:COPPER ALLOY
処理：ニッケル下地部分金メッキ（接触部及びテール部）
FINISH :PARTLY GOLD(CONTACT,TAIL) OVER NICKEL PLATING
- アクチュエータ・・・材質：耐熱性樹脂 灰色 UL94V-0
ACTUATOR MATERIAL :HEAT RESISTANT POLYMER GRAY UL94-V0
- ネイル・・・材質：銅合金
NAIL MATERIAL:COPPER ALLOY
処理：ニッケル下地すずめっき
FINISH :TIN OVER NICKEL PLATING

REVISED EC NO: J2009-1320 DRAWN: TAKAHASHI 03/2008/11/21 CHKD: THARUYAMA 2008/11/21 APPR: NUKITA 2008/11/21	DESCRIPTION	GENERAL TOLERANCES (UNLESS SPECIFIED)		DIMENSION STYLE MM ONLY		SCALE 15:1	DESIGN UNITS METRIC	THIRD ANGLE PROJECTION	
		10 UNDER	± 0.2	DRAWN BY K. SATO	DATE 2007/01/26	TITLE 0.3 FPC CONN. E/O H=1.1 HSG ASSY LONG ACTUATOR			
		10 OVER 30 UNDER	± 0.25	CHECKED BY H. HIRATA	DATE 2007/01/26	MATERIAL NO. DOCUMENT NO.			
		30 OVER	± 0.3	APPROVED BY M. SASAO	DATE 2007/01/26	SHEET NO. 1 OF 2			
ANGULAR ± 3 °		DRAFT WHERE APPLICABLE MUST REMAIN WITHIN DIMENSIONS		SEE CHART		MOLEX INCORPORATED SD-501616-007			
THIS DRAWING CONTAINS INFORMATION THAT IS PROPRIETARY TO MOLEX INCORPORATED AND SHOULD NOT BE USED WITHOUT WRITTEN PERMISSION									

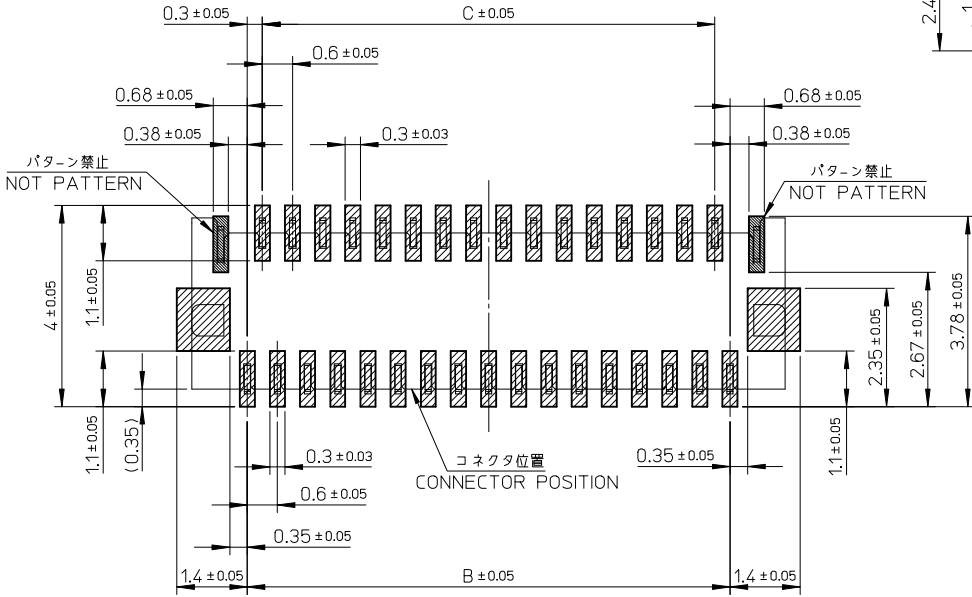

参考基板レイアウト (マウント面)
P.C. BOARD PATTERN DIM.(REF.)

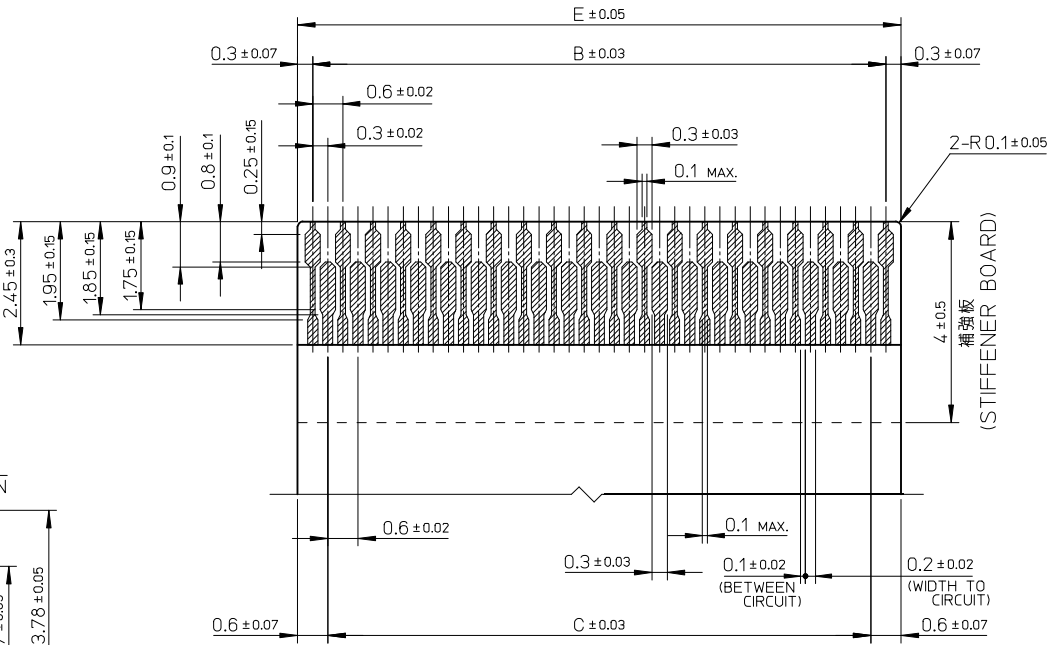

適合FPC推奨寸法
仕上がり厚さ : 0.2±0.03
APPLY FPC
RECOMMENDED DIM.
THICKNESS : 0.2±0.03

15.6	14.4	15.0	501616-5185	501616-5150	51
13.8	12.6	13.2	501616-4585	501616-4550	45
12.6	11.4	12.0	501616-4185	501616-4150	41
12.0	10.8	11.4	501616-3985	501616-3950	39
10.8	9.6	10.2	501616-3585	501616-3550	35
E	C	B	EMBOSSD TAPE ORDER No.	MATERIAL NO.	CIRCUIT

- 注記
- 基板実装前にアクチュエータを操作しないで下さい。
PLEASE DO NOT OPERATE THE ACTUATOR BEFORE MOUNTING.
必ず基板に実装し、FPCを挿入してからアクチュエータを操作して下さい。
PLEASE OPERATE THE ACTUATOR AFTER MOUNTING ON THE SUBSTRATE, AND MATING FPC.
 - ELV及びRoHS適合品
ELV AND RoHS COMPLIANT

REVISED EC NO: J2009-1320 DRAWN: TAKAHASHI 03 2008/11/24 CHKD: THARUYAMA 2008/11/24 APPR: NUKITA 2008/11/24	DESCRIPTION	GENERAL TOLERANCES (UNLESS SPECIFIED)		DIMENSION STYLE MM ONLY		SCALE 10:1	DESIGN UNITS METRIC	THIRD ANGLE PROJECTION	
		10 UNDER	±0.2	DRAWN BY K.SATO	DATE 2007/01/26	TITLE 0.3 FPC CONN. E/O H=1.1 HSG ASSY LONG ACTUATOR			
		10 OVER 30 UNDER	±0.25	CHECKED BY H.HIRATA	DATE 2007/01/26	MOLEX MOLEX INCORPORATED DOCUMENT NO. SD-501616-007 SHEET NO. 2 OF 2			
		30 OVER	±0.3	APPROVED BY M.SASAO	DATE 2007/01/26				
		ANGULAR ±3 ° DRAFT WHERE APPLICABLE MUST REMAIN WITHIN DIMENSIONS		MATERIAL NO. SEE CHART		THIS DRAWING CONTAINS INFORMATION THAT IS PROPRIETARY TO MOLEX INCORPORATED AND SHOULD NOT BE USED WITHOUT WRITTEN PERMISSION			

NOTES

- 製品 (501616-**50) の詳細寸法については、図面 SD-501616-007 をご参照下さい。
IN THE PACKAGE, PART NO. 501616-**50 DETAILED DIMENSIONS, REFER TO SALES DRAWING NO. SD-501616-007.
- 梱包数量 : 3000個/リール
NUMBER OF CONNECTORS : 3000 PCS/REEL
- リードテープ長さ
LEAD TAPE LENGTH

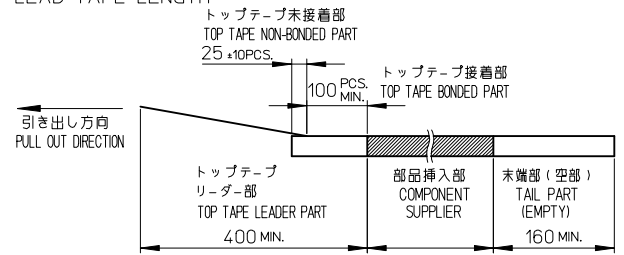

- 材料
キャリアテープ : ポリスチレン (PS)
トップテープ : PET, PE, PEF
リール : ポリスチレン (PS) <リサイクル材を含む>
MATERIAL
CARRIER TAPE : POLYSTYRENE (PS)
TOP TAPE : PET, PE, PEF
REEL : POLYSTYRENE (PS) <RECYCLE MATERIAL CONTAINED>
- ELV及びRoHS適合品
ELV AND RoHS COMPLIANT

37.4	33.4	32±0.3	28.4	14.2	15.4	17.4	501616-5185	51
					13.6	15.6	501616-4585	45
29.4	25.4	24±0.3	++	11.5	12.4	14.4	501616-4185	41
					11.8	13.8	501616-3985	39
					10.6	12.6	501616-3585	35
G	F	E キャリアテープ幅 EMBOSSED TAPE WIDTH	D	C	B	A	EMBOSSED PACKAGE オーダー番号 ORDER No.	極数 CIRCUIT

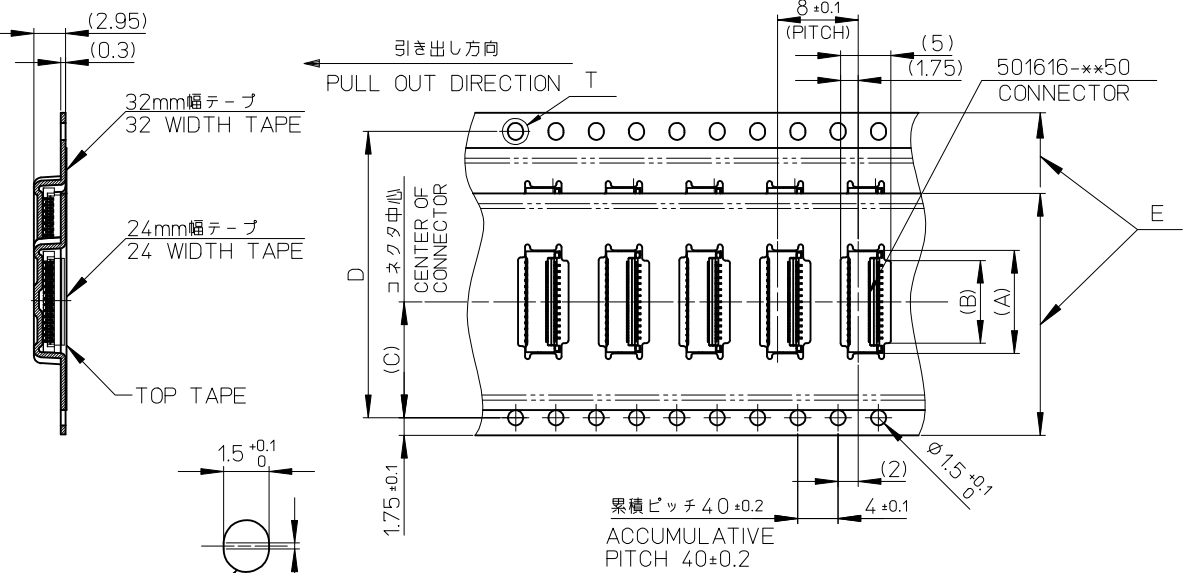
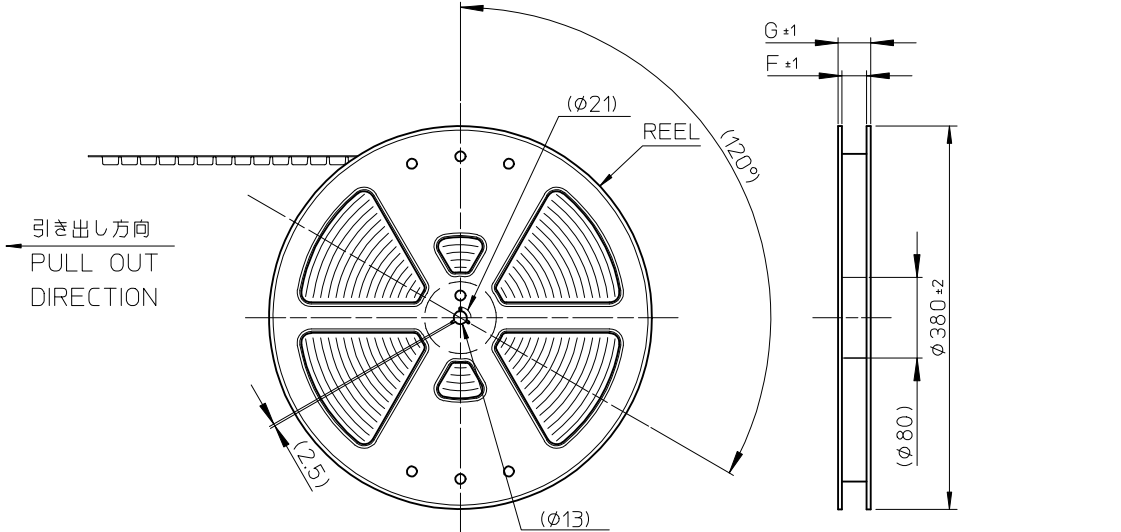

REVISED EC NO: J2009-1784 DRWN:MKAWABATA 2009/01/26 CHKD:HSHIROYAMA 2009/01/26 APPR:HSHIROYAMA 2009/01/26	DESCRIPTION	GENERAL TOLERANCES (UNLESS SPECIFIED)		DIMENSION STYLE MM ONLY		SCALE ---	DESIGN UNITS METRIC		THIRD ANGLE PROJECTION	
		10 UNDER	± ---	DRAWN BY K. SATO	DATE 2007/05/14	TITLE 0.3 FPC CONN. H=1.1 EMBSTP PKG (LONG-ACT)				
		10 OVER 30 UNDER	± ---	CHECKED BY H. HIRATA	DATE 2007/05/14	MOLEX INCORPORATED				
		30 OVER	± ---	APPROVED BY M. SASAO	DATE 2007/05/14	DOCUMENT NO. SD-501616-008				
ANGULAR	± --- °	DRAFT WHERE APPLICABLE MUST REMAIN WITHIN DIMENSIONS		SEE CHART		SHEET NO. 1 OF 1				
SIZE A3	THIS DRAWING CONTAINS INFORMATION THAT IS PROPRIETARY TO MOLEX INCORPORATED AND SHOULD NOT BE USED WITHOUT WRITTEN PERMISSION									