

CHIA SHIN KNOB CO LTD

SINCE 1976

High Quality, Attractive Prices, Excellent Services

multicomp[®]

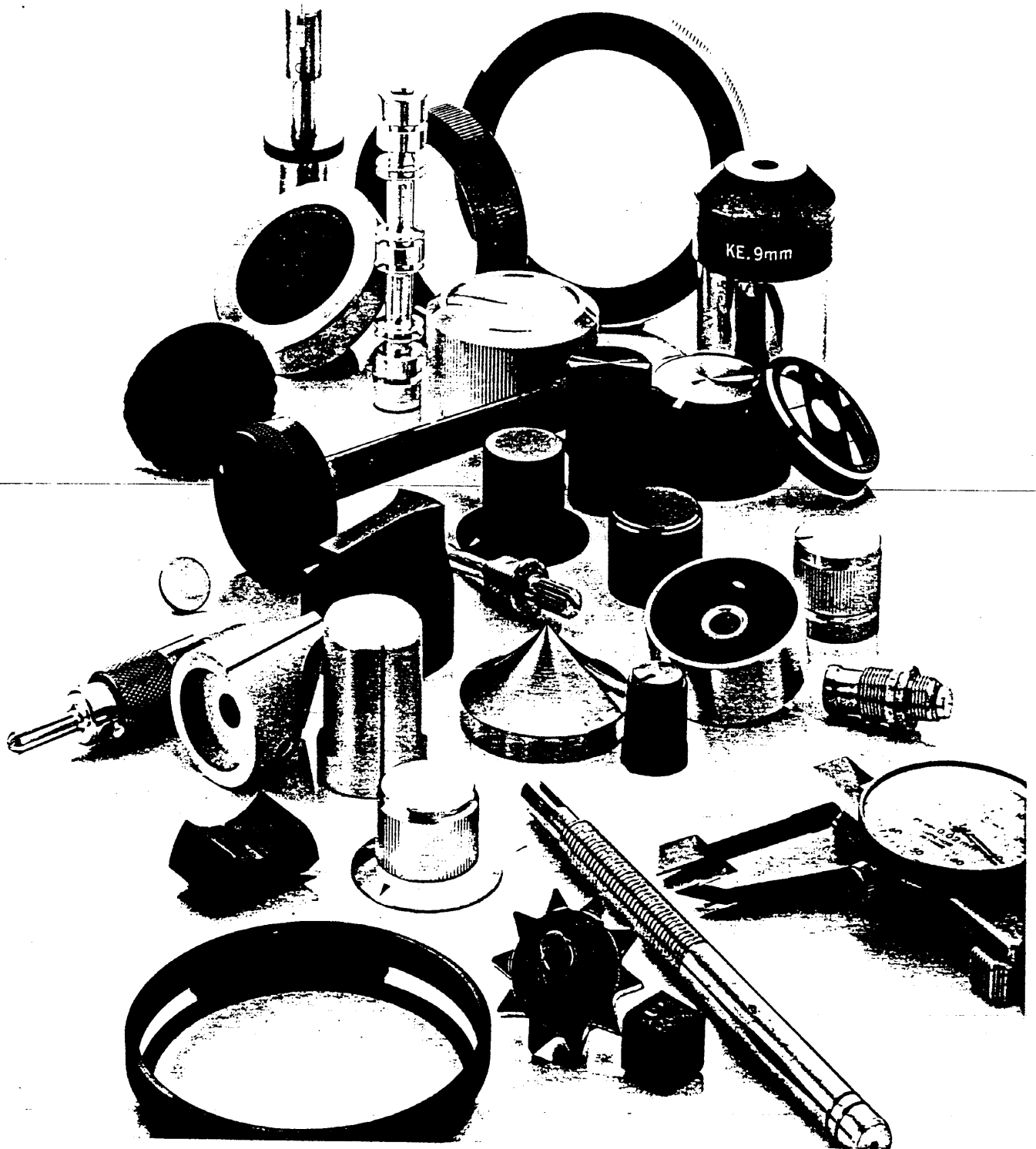

OEMS & Customers' Specifications Are Welcome.

Chia Shin Knobs

CS SERIES: MACHINED SOLID ALUMINUM KNOBS.

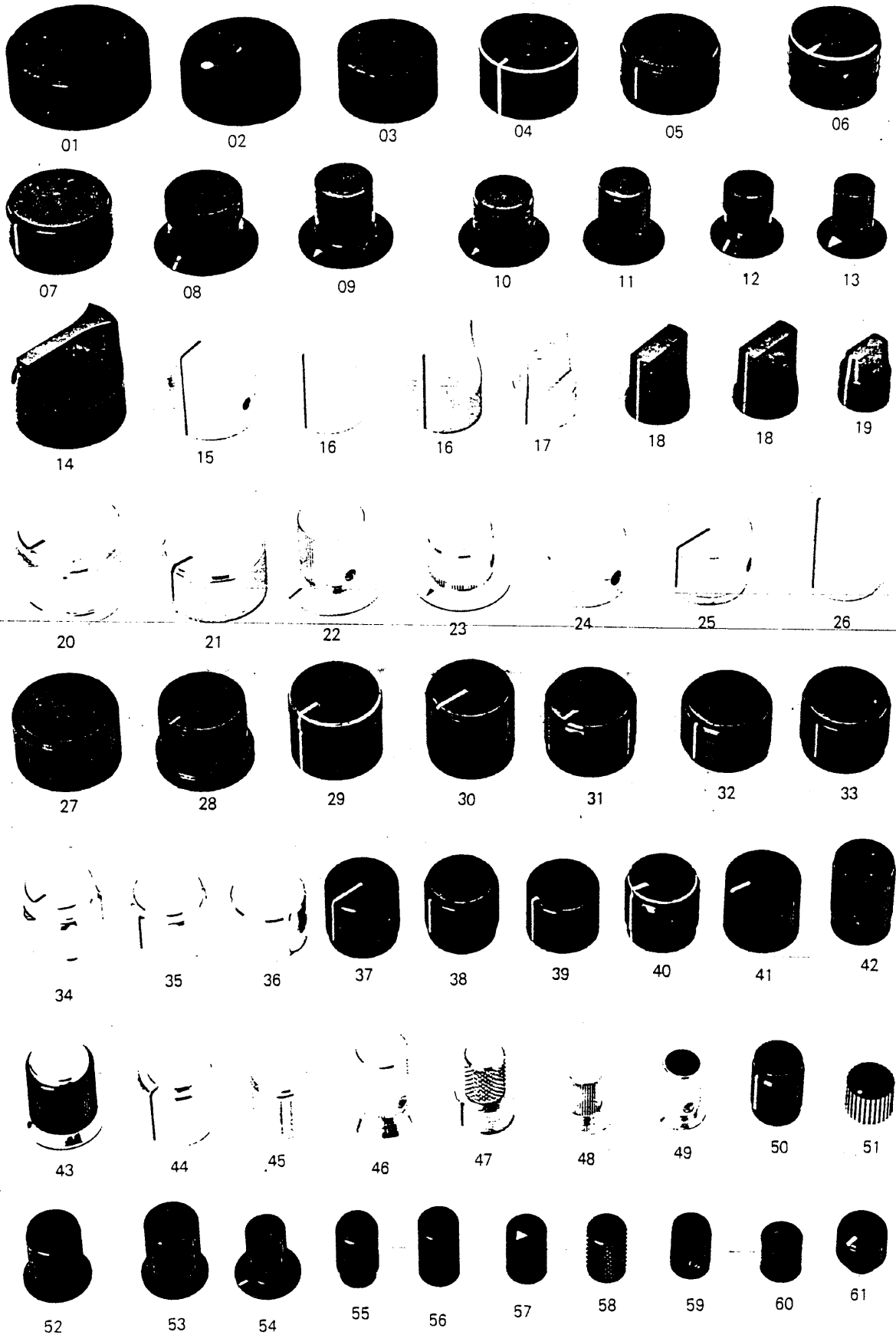

CC SERIES: MACHINED ALUMINUM SHELL WITH PLASTIC INSERT KNOBS.

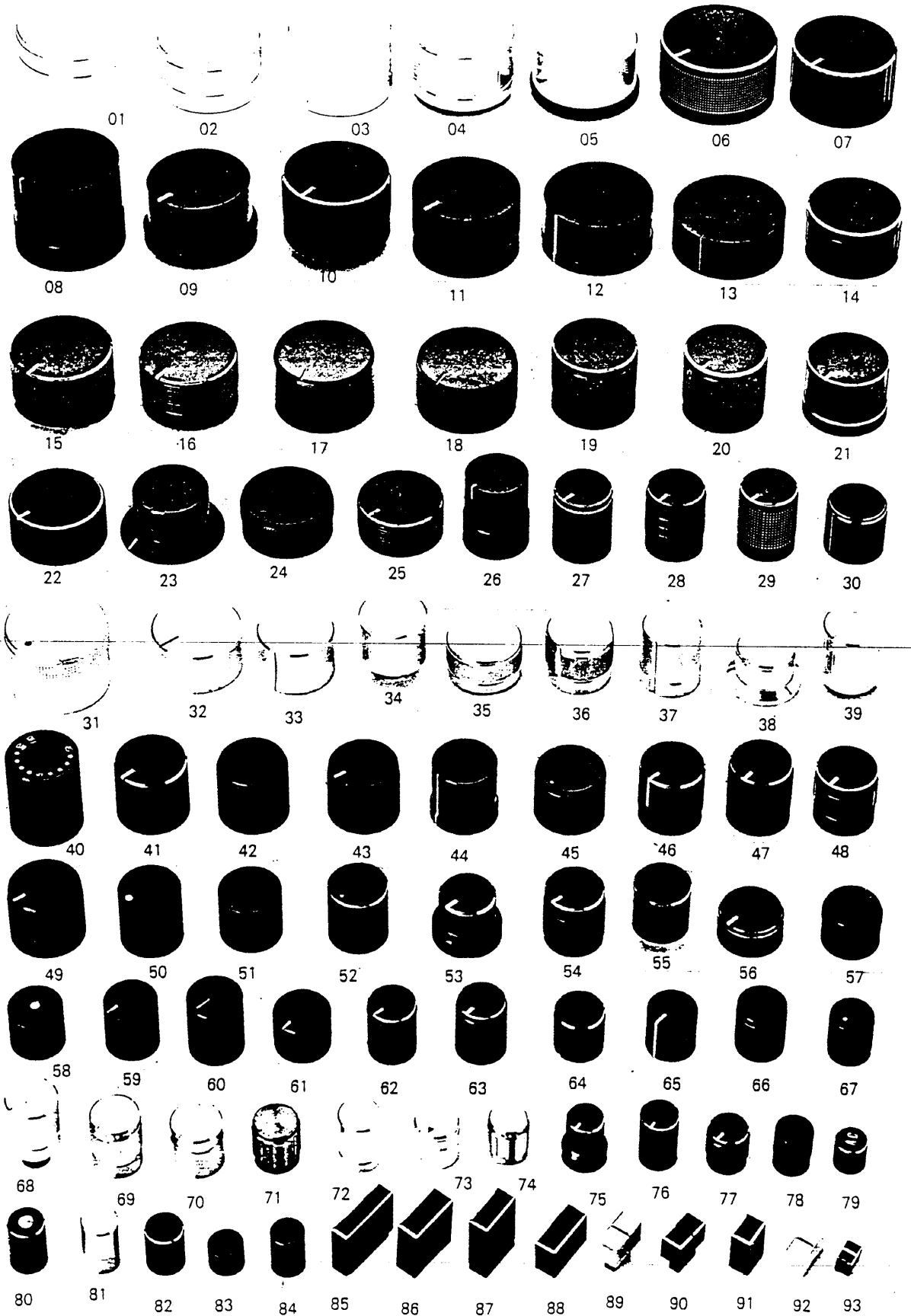

CP SERIES: BAKELITE KNOBS.
 CP SERIES: ABS PLASTIC KNOBS.

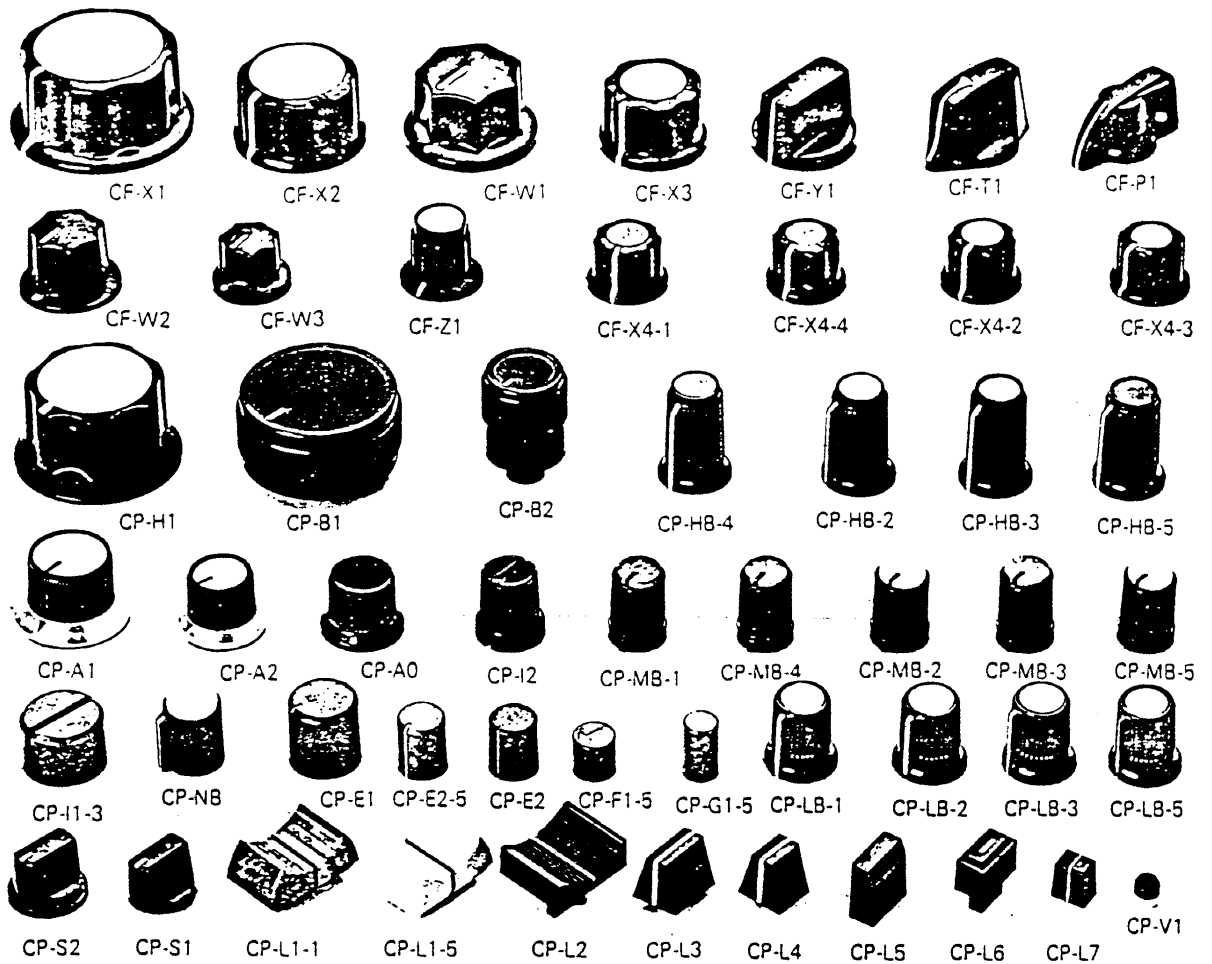

OEMS Welcome

ITEM OF PRODUCTION:

- Aluminum Knobs
- Plastic Knobs
- Bakelite Knobs
- Shaft (Tuning/Valve/Printer)
- Foot Stands (Stainless Steel/Aluminum Shell)
- Video Cassette Parts
- Optical Instrument Parts
- Roller
- Plastic-Injection Molds

Material:

Aluminum/Brass/steel (bearing, alloy, carbon, tool, stainless)

Size:

Outside diameter: $\phi 0.5\text{mm}-\phi 120\text{mm}$

VARIOUS HARDWARE PARTS
FOOT STANDS/TUNING SHAFT/VALVE SHAFT/PRINTER SHAFT....ETC.

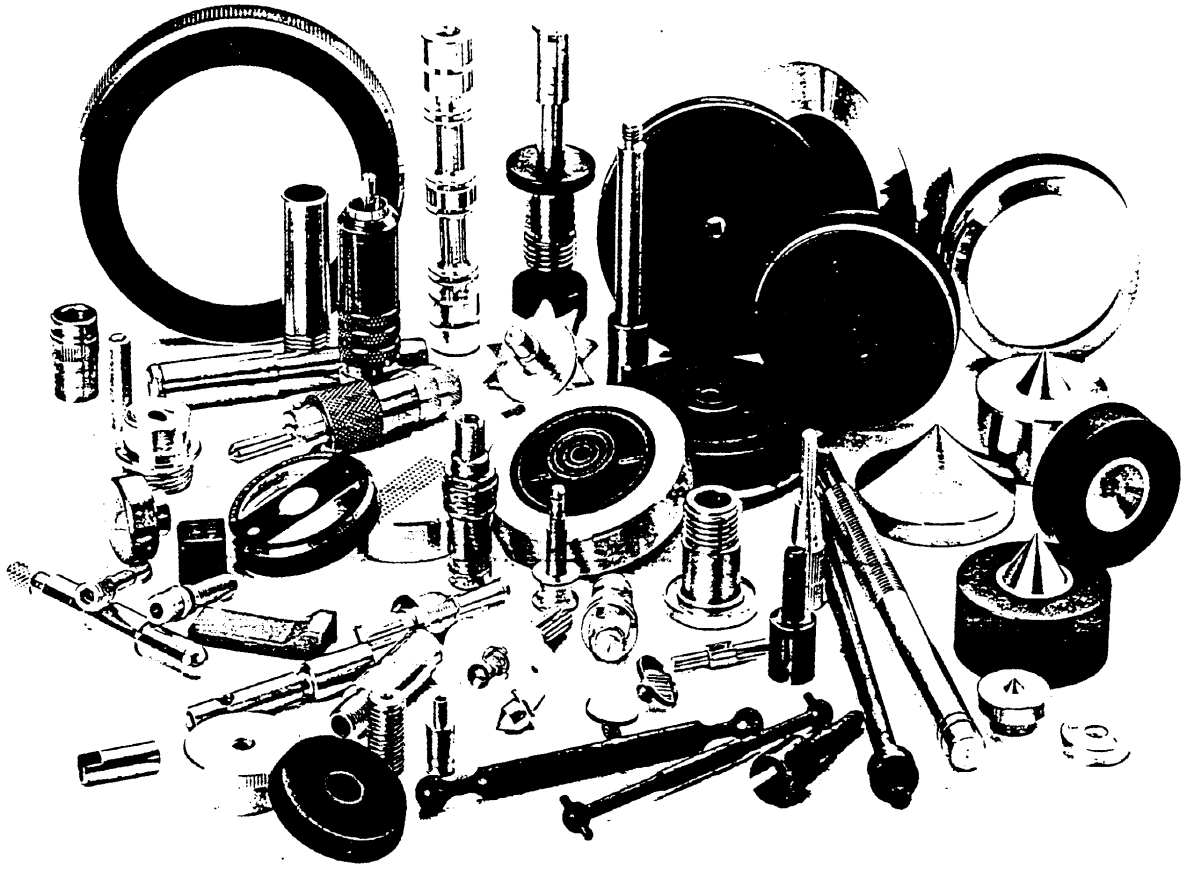

PARTS OF OPTICAL INSTRUMENTS



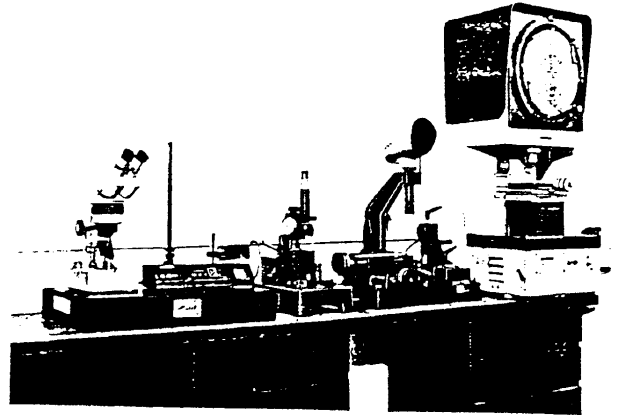
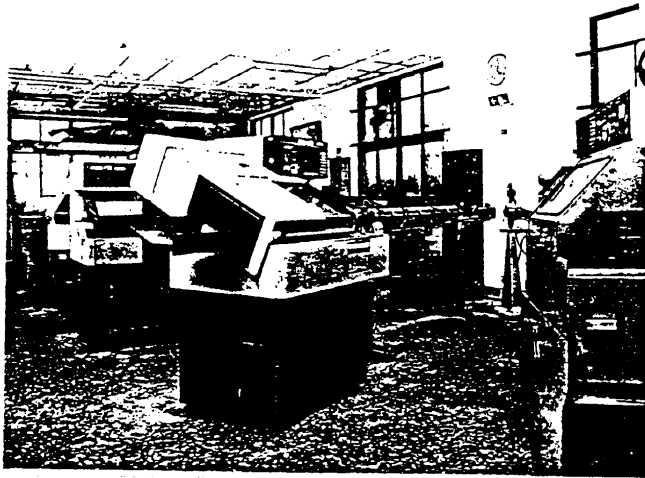

MAIN EQUIPMENTS:

■ FACTORY AREA	10.600 ft ²
■ CNC AUTOMATIC LATHE	6 SETS
■ SEMIAUTOMATIC LATHE	12 SETS
■ HAND LATHE	8 SETS
■ PRESS	8 SETS
■ MILLING MACHINE	3 SETS
■ PLASTIC INJECTION MACHINE	2 SETS
■ EXTERNAL/INTERNAL GRINDING MACHINE	1 SET
■ DRILLING MACHINE	8 SETS
■ AUTOMATIC TAPPING MACHINE	6 SETS
■ KNURLING MACHINE	8 SETS
■ HAIR LINE FINISHING MACHINE	4 SETS
■ BLASTING EQUIPMENT	1 EA
■ ANODIZING EQUIPMENT	1 EA
■ SCREW AIR-COMPRESSOR	1 EA

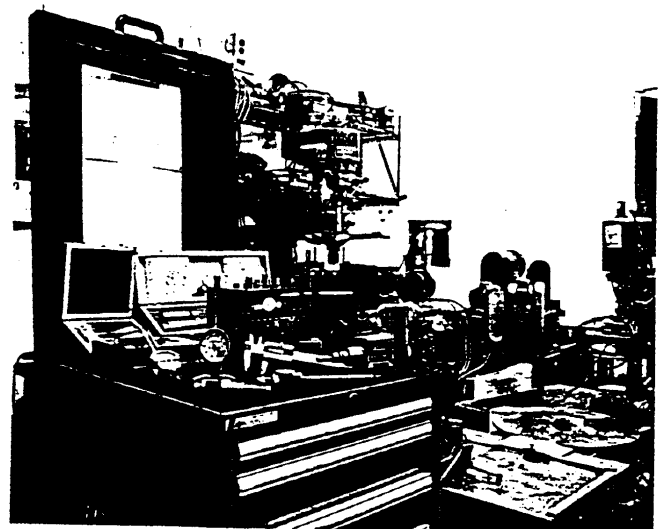
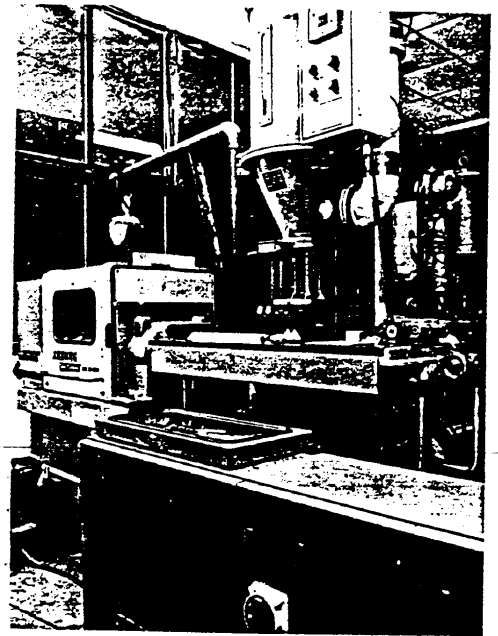

CHIA SHIN KNOBS CO., LTD.

ESTABLISHED IN 1976

351, Yungho Road, Chungho City, Taipei Hsien, Taiwan, R.O.C.

Tel:(02)2251216/7, 2250953 Fax: 886-2-2227312



MACHINED SOLID ALUMINUM KNOBS WITH SCREW									
MODEL NO	SIZE	FINISH	COLOR	SHAFT HOLE	MODEL NO	SIZE	FINISH	COLOR	SHAFT HOLE
CS-01	45 Ø	HAIRLINE	BLACK	6.0	CS-26	22 Ø	SANDBLAST	NATURAL	6.4
CS-02	38 Ø	SANDBLAST	BLACK	6.4	CS-27	20 Ø	SPUN	BLACK	6.4
CS-03	32 Ø	SANDBLAST	BLACK	6.4	CS-28	25 Ø	SANDBLAST	BLACK	6.4
CS-04	32 Ø	SPUN	BLACK	6.4	CS-29	25 Ø	SPUN	BLACK	3.2
CS-05	32 Ø	SPUN	BLACK	6.4	CS-30	25 Ø	SPUN	BLACK	6.4
CS-06	32 Ø	SPUN	BLACK	6.4	CS-31	25 Ø	SPUN	BLACK	6.4
CS-07	32 Ø	SPUN	BLACK	6.4	CS-32	25 Ø	SPUN	BLACK	6.4
CS-08	32 Ø	SPUN	BLACK	6.4	CS-33	25 Ø	SPUN	BLACK	6.4
CS-09	32 Ø	SPUN	BLACK	6.4	CS-34	22 Ø	SPUN	NATURAL	6.4
CS-10	32 Ø	SPUN	BLACK	6.4	CS-35	21 Ø	SPUN	NATURAL	6.4
CS-11	32 Ø	SPUN	BLACK	6.4	CS-36	20 Ø	SPUN	NATURAL	6.4
CS-12	24 Ø	SPUN	BLACK	6.4	CS-37	19 Ø	SPUN	BLACK	6.4
CS-13	22 Ø	SPUN	BLACK	6.4	CS-38	19 Ø	SPUN	BLACK	6.4
CS-14	38 Ø	SANDBLAST	BLACK	6.4	CS-39	19 Ø	SPUN	BLACK	6.4
CS-15	25 Ø	SANDBLAST	NATURAL	6.4	CS-40	20 Ø	NATURAL	BLACK	6.4
CS-16	22 Ø	SANDBLAST	GOLD	6.4	CS-41	20 Ø	SPUN	BLACK	6.4
CS-17	19 Ø	SANDBLAST	NATURAL	6.4	CS-42	16 Ø	HAIRLINE	BLACK	6.0
CS-18	19 Ø	SANDBLAST	BLACK	3.2	CS-43	19 Ø	SPUN	TWO-TONE	3.2
CS-19	15 Ø	SANDBLAST	BLACK	3.2	CS-44	6.0F	SPUN	NATURAL	6.0
CS-20	25 Ø	SPUN	NATURAL	6.4	CS-45	15 Ø	SPUN	NATURAL	6.4
CS-21	29 Ø	HAIRLINE	NATURAL	6.4	CS-46	16 Ø	SPUN	NATURAL	3.2
CS-22	28 Ø	SPUN	NATURAL	6.4	CS-47	15 Ø	SPUN	GOLD	3.2
CS-23	28 Ø	SPUN	NATURAL	6.4	CS-48	13 Ø	SPUN	NATURAL	3.2
CS-24	28 Ø	SPUN	NATURAL	6.0	CS-49	12 Ø	SPUN	BLACK	3.2
CS-25	29 Ø	SPUN	NATURAL	6.4	CS-50	12 Ø	SPUN	BLACK	6.4



CHIA SHIN KNOBS CO., LTD.

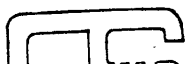

351, YUNGHO ROAD, CHUNGHO CITY,
TAIPEI HSIEN, TAIWAN, R.O.C.

MACHINED SOLID ALUMINUM KNOBS WITH SCREW

MODEL NO	SIZE	FINISH	COLOR	SHAFT HOLE	MODEL NO	SIZE	FINISH	COLOR	SHAFT HOLE
CS-51	12 Ø	SPUN	TWO TONE	6.0					
CS-52	16 Ø	SPUN	BLACK	6.0					
CS-53	16 Ø	SPUN	BLACK	3.2					
CS-54	16 Ø	SPUN	BLACK	3.2					
CS-55	13 Ø	SPUN	BLACK	3.2					
CS-56	12 Ø	SANDBLAST	BLACK	6.0					
CS-57	13 Ø	SPUN	BLACK	3.2					
CS-58	12 Ø	SPUN	BLACK	3.2					
CS-59	13 Ø	SPUN	BLACK	3.2					
CS-60	10 Ø	SANDBLAST	BLACK	6.0					
CS-61	12 Ø	SPUN	BLACK	6.0					

1. MATERIAL: 6063 ALUMINUM ALLOY ROD, OR 997 PURE ALUMINUM ROD.
2. SHAFT HOLE SIZE: ① 6.4MM ② 6.0MM ③ 3.2MM ④ 4.8MM
3. NUMBER OF CARBON STEEL LINEAR HEX SOCKET HEAD SET SCREW:
 - 1. 1 PLACE, OR 2 PLACES.
 - 2. METRIC, SLOTTED HEAD SCREWS ARE AVAILABLE IF SPECIFIED.

** ALL ABOVE SPECIFICATIONS ARE CHANGEABLE, WE CAN MAKE ANY SIZE TO YOUR SPECIAL NEEDS.**

ALUMINUM SHELL KNOBS WITH PLASTIC INSERT									
MODEL NO	SIZE	FINISH	COLOR	SHAFT HOLE	MODEL NO	SIZE	FINISH	COLOR	SHAFT HOLE
CC-01	45	SPUN	NATURAL	T	CC-29	20	SPUN	TWO TONE	T
CC-02	40	HAIRLINE	NATURAL	T	CC-30	20	SANDBLAST	TWO TONE	T
CC-03	40	SANDBLAST	CHAMPAGNE	T	CC-31	34	SANDBLAST	NATURAL	
CC-04	40	SPUN	NATURAL	T	CC-32	28	SPUN	NATURAL	T
CC-05	40	SPUN	NATURAL	T	CC-33	25	SANDBLAST	NATURAL	T
CC-06	45	SPUN	TWO TONE	T	CC-34	25	HAIRLINE	NATURAL	T
CC-07	45	SPUN	BLACK	T	CC-35	24	HAIRLINE	GOLD	T
CC-08	40	SANDBLAST	BLACK	T	CC-36	25	HAIRLINE	GOLD	T
CC-09	38	SPUN	BLACK	T	CC-37	20	SANDBLAST	GOLD	T
CC-10	40	HAIRLINE	BLACK	T	CC-38	22	SPUN	NATURAL	T
CC-11	40	HAIRLINE	BLACK	T	CC-39	20	SPUN	NATURAL	T
CC-12	40	SPUN	BLACK	T	CC-40	22	SPUN	BLACK	T
CC-13	40	SANDBLAST	BLACK	T	CC-41	22	HAIRLINE	BLACK	T
CC-14	40	SPUN	BLACK	T	CC-42	22	SANDBLAST	BLACK	T
CC-15	39	HAIRLINE	BLACK	T	CC-43	22	HAIRLINE	BLACK	T
CC-16	40	SPUN	BLACK	T	CC-44	22	SANDBLAST	BLACK	T
CC-17	40	SANDBLAST	BLACK	T	CC-45	22	SANDBLAST	BLACK	T
CC-18	35	SANDBLAST	BLACK	T	CC-46	20	HAIRLINE	BLACK	T
CC-19	25	HAIRLINE	BLACK	T	CC-47	19	HAIRLINE	BLACK	T
CC-20	29	SPUN	TWO TONE	T	CC-48	19	SPUN	BLACK	T
CC-21	30	SPUN	BLACK	T	CC-49	20	HAIRLINE	BLACK	T
CC-22	30	SPUN	BLACK	T	CC-50	20	SANDBLAST	BLACK	T
CC-23	35	SPUN	BLACK	T	CC-51	20	SANDBLAST	BLACK	T
CC-24	31	SANDBLAST	BLACK	T	CC-52	18	SPUN	BLACK	T
CC-25	25	SPUN	TWO TONE	T	CC-53	17	SPUN	BLACK	T
CC-26	18	SANDBLAST	BLACK	T	CC-54	19	SPUN	BLACK	T
CC-27	20	SANDBLAST	BLACK	T	CC-55	18	SPUN	BLACK	T
CC-28	20	SPUN	BLACK	T	CC-56	17	SANDBLAST	BLACK	T

ALUMINUM SHELL KNOBS WITH PLASTIC INSERT									
MODEL NO	SIZE	FINISH	COLOR	SHAFT HOLE	MODEL NO	SIZE	FINISH	COLOR	SHAFT HOLE
CC-57		SANDBLAST	BLACK	T	CC-76	11	SPUN	BLACK	T
CC-58	16	SANDBLAST	BLACK	T	CC-77	12	SPUN	BLACK	T
CC-59	16	SANDBLAST	BLACK	T	CC-78	11	SPUN	BLACK	T
CC-60	16	SANDBLAST	BLACK	T	CC-79	9	SPUN	BLACK	T
CC-61	17	SPUN	BLACK	T	CC-80	10.5	SPUN	BLACK	S
CC-62	15	SPUN	BLACK	T	CC-81	10	SPUN	GOLD	S
CC-63	15	SANDBLAST	BLACK	T	CC-82	11	SPUN	BLACK	S
CC-64	15	SANDBLAST	BLACK	T	CC-83	10.5	SANDBLAST	BLACK	T
CC-65	15	SANDBLAST	BLACK	T	CC-84	10	SANDBLAST	BLACK	T / S
CC-66	15	HAIRLINE	BLACK	T	CC-85	5X20	SANDBLAST	BLACK	S
CC-67	13	SANDBLAST	BLACK	T	CC-86	6X16	SANDBLAST	BLACK	S
CC-68	15	SANDBLAST	NATURAL	T	CC-87	6X14	SANDBLAST	BLACK	S
CC-69	15	SPUN	GOLD	T	CC-88	6X16	HAIRLINE	BLACK	F
CC-70	15	SANDBLAST	GOLD	T	CC-89	6x12	HAIRLINE	GOLD	F
CC-71	14	SPUN	GOLS	T	CC-90	6X12	HAIRLINE	BLACK	F
CC-72	12	SPUN	NATURAL	T	CC-91	6X9	SANDBLAST	BLACK	S
CC-73	13	SANDBLAST	NATURAL	T	CC-92	6X12	SANDBLAST	NATURAL	F
CC-74	12	SPUN	GOLD	T	CC-93	5X9	HAIRLINE	BLACK	
CC-75	11	SPUN	BLACK	T					

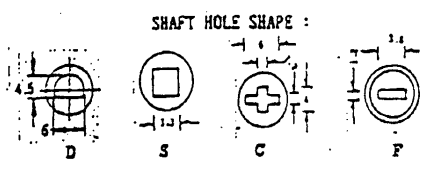
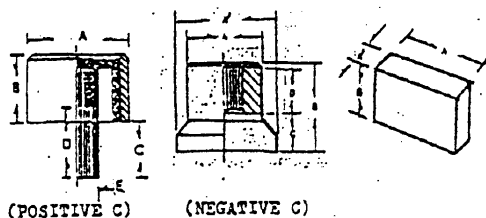

- SHAFT HOLE SHAPE:
 T: FOR 18/36 TOOTH KNURLED SHAFT (6MM DIA.)
 D: FOR "D" TYPE SHAFT (6MM DIA.)
 S: FOR SQUARE TYPE SHAFT.
 C: FOR FLAT TYPE SHAFT.
 F: FOR FLAT TYPE SHAFT.
 * SHAFT T AND D ARE ROTARY KNOBS;
 * SHAFT S AND C AND F ARE PUSH BUTTON OR LEVEL KNOBS.
- EVERY MODEL NUMBER HAS SEVERAL SETS OF DIMENTION C & D FOR CHOICE. YOU CAN ASK FOR YOUR DIMENTIONS.

** IF YOU WANT TO CHANGE DIMENTIONS OF A MODEL. PLEASE SPECIFY THEM BEHIND ORDER NUMBER.

** ALL ABOVE SPECIFICATIONS ARE CHANGEABLE, WE CAN MAKE ANY SIZE TO YOUR SPECIAL NEED. **

BAKELITE KNOBS & ABS PLASTIC KNOBS									
MODEL NO	SIZE	MATERIAL	SHAFT TYPE	SHAFT HOLE	MODEL NO	SIZE	MATERIAL	SHAFT TYPE	SHAFT HOLE
CF-X1	45	BAKELITE	S & T	6.4	CP-MB-3	13.2	ABS (BLUE)	T	6.0
CF-X2	33	BAKELITE	S & T	6.4	CP-MB-4	13.2	ABS (GREEN)	T	6.0
CF-W1	33.4	BAKELITE	S & T	6.4	CP-MB-5	13.2	ABS (GRAY)	T	6.0
CF-X3	27	BAKELITE	S & T	6.4	CP-11-3	18	BLUE ABS	T	6.0
CF-Y1	27	BAKELITE	S & T	6.4	CP-NB-1	14.5	BAKELITE (RED)	S	6.4
CF-T1	32	BAKELITE	S & T	6.4	CP-NB-2	14.5	BAKELITE (Y)	S	6.4
CF-P1	32	BAKELITE	S & T	6.4	CP-NB-3	14.5	BAKELITE (BLUE)	S	6.4
CF-W2	24.2	BAKELITE	S & T	6.4	CP-NB-4	14.5	BAKELITE (GREEN)	S	6.4
CF-W3	19	BAKELITE	S & T	6.4	CP-E1	15.4	ABS	T	6.0
CF-Z1	20.5	BAKELITE	S & T	6.4	CP-E2-5	10.8	GRAY ABS	T	6.0
CF-X4-1	19.6	BAKELITE	S & T	6.4	CP-E2	10.8	BLACK ABS	T	6.0
CF-X4-2	19.6	BAKELITE	S & T	6.4	CP-F1-5	9.5	GRAY ABS	T	6.0
CF-X4-3	19.6	BAKELITE	S & T	6.4	CP-G1-5	8.0	GRAY ABS	PUSH	3.3X3.3
CF-X4-4	19.6	BAKELITE	S & T	6.4	CP-LB-1	16	ABS (RED)	T	6.0
CP-H1	45	ABS	T	6.0	CP-LB-2	16	ABS (YELLOW)	T	6.0
CP-B1	40	ABS	T	6.0	CP-LB-3	16	ABS (BLUE)	T	6.0
CP-B2	18	ABS	T	6.0	CP-LB-4	16	ABS (GREEN)	T	6.0
CP-HB-1	17	ABS (RED)	T	6.0	CP-LB-5	16	ABS (GRAY)	T	6.0
CP-HB-2	17	ABS (YELLOW)	T	6.0	CP-S2	16.5	ABS	T/D	6.0
CP-HB-3	17	ABS (BLUE)	T	6.0	CP-S1	14	ABS	T/D	6.0
CP-HB-4	17	ABS (GREEN)	T	6.0	CP-L1-1	24X15	ABS (RED)	SLIDE	8X1.9
CP-HB-5	17	ABS (GRAY)	T	6.0	CP-L1-5	24X15	ABS (GRAY)	SLIDE	8X1.9
CP-A1	25	ABS	T	6.0	CP-L2	20X17	ABS	SLIDE	4X1.2
CP-A2	19	ABS	T	6.0	CP-L3	14X11	ABS	SLIDE	4X1.2
CP-A0	19	ABS	T	6.0	CP-L4	10X11	ABS	SLIDE	4X1.2
CP-12	15.6	BAKELITE	S & T	6.4	CP-L5	13X6	ABS	PUSH	3X3.5
CP-MB-1	13.2	ABS (RED)	T	6.0	CP-L6	13X7	ABS	SLIDE	4X1.2
CP-MB-2	13.2	ABS (YELLOW)	T	6.0	CP-L7	9X6	ABS	PUSH	3X3

1. SHAFT HOLE TYPE :
S: FOR SCREW, 6.4MM, 6.0MM
T: FOR 18/36 TOOTH KNURLED SHAFT (6MM DIA.)
D: FOR "D" TYPE SHAFT (6MM DIA.)

** ALL ABOVE SPECIFICATIONS ARE CHANGEABLE, WE CAN MAKE ANY SIZE TO YOUR SPECIAL NEEDS.**

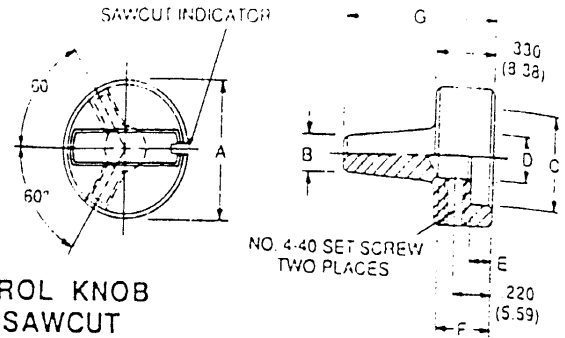
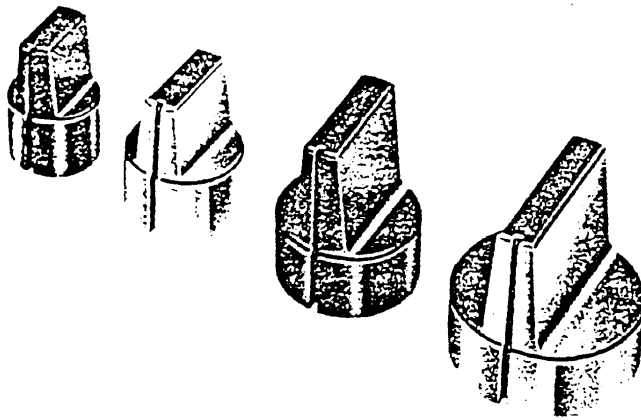

**CONTROL KNOB
WITH SAWCUT
INDICATOR**

1/8" SHAFT = .126"(3.20)
1/4" SHAFT = .251"(6.35)

CS-17 TYPE:

DIAMETER DIMENSIONS		DIAMETER DIMENSIONS		DIAMETER DIMENSIONS		DIAMETER DIMENSIONS	
A	B	C	D	E	F	G	
.500 (12.7)	.200 (5.08)	.370 (9.40)		.120 (3.05)	.330 (8.38)	.750 (19.0)	
.620 (15.8)	.200 (5.08)	.390 (9.90)		.120 (3.05)	.330 (8.38)	.750 (19.0)	
.750 (19.0)	.200 (5.08)	.510 (13.0)		.120 (3.05)	.330 (8.38)	.900 (22.9)	
.940 (23.9)	.200 (5.08)	.710 (18.0)		.120 (3.05)	.330 (8.38)	.900 (22.9)	

COLOR: NATURAL AND BLACK D: 1/8" SHAFT (3.2MM) OR 1/4" SHAFT (6.35MM)

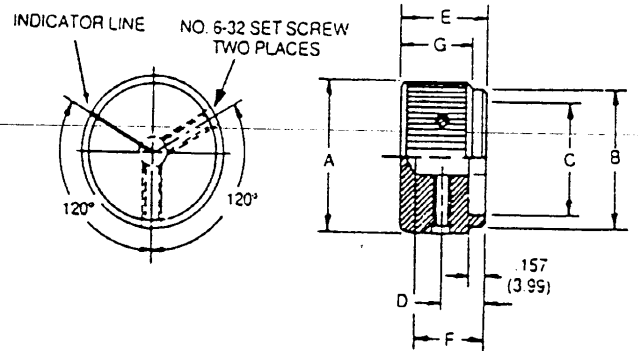
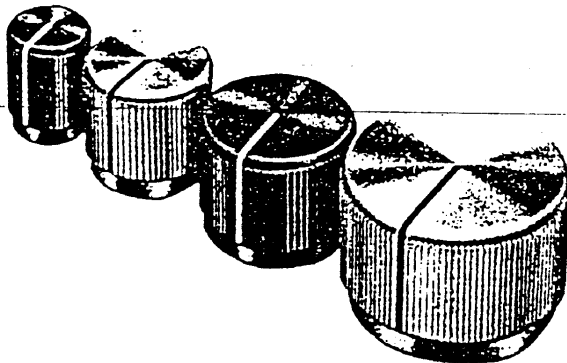

**STRAIGHT KNURL
WITH TOP AND SIDE
INDICATOR**

1/8" SHAFT = .126"(3.20)
1/4" SHAFT = .251"(6.37)

CS-37 TYPE:

DIAMETER DIMENSIONS		DIAMETER DIMENSIONS		DIAMETER DIMENSIONS		DIAMETER DIMENSIONS	
A	B	C	D	E	F	G	
.500 (12.7)	.450 (11.4)	.380 (9.65)	.280 (7.11)	.630 (16.0)	.510 (13.0)	.530 (13.5)	
.750 (19.0)	.700 (17.8)	.590 (14.9)	.280 (7.11)	.630 (16.0)	.510 (13.0)	.530 (13.5)	
.940 (23.9)	.880 (22.3)	.710 (18.0)	.280 (7.11)	.630 (16.0)	.510 (13.0)	.530 (13.5)	
1.25 (31.7)	1.20 (30.5)	.980 (24.9)	.280 (7.11)	.630 (16.0)	.510 (13.0)	.530 (13.5)	

