

MMBZ5221BLT1 Series

Preferred Device

Zener Voltage Regulators

225 mW SOT-23 Surface Mount

This series of Zener diodes is offered in the convenient, surface mount plastic SOT-23 package. These devices are designed to provide voltage regulation with minimum space requirement. They are well suited for applications such as cellular phones, hand held portables, and high density PC boards.

Features

- 225 mW Rating on FR-4 or FR-5 Board
- Zener Voltage Range – 2.4 V to 91 V
- Package Designed for Optimal Automated Board Assembly
- Small Package Size for High Density Applications
- ESD Rating of Class 3 (>16 KV) per Human Body Model
- Pb-Free Packages are Available

Mechanical Characteristics

CASE: Void-free, transfer-molded, thermosetting plastic case

FINISH: Corrosion resistant finish, easily solderable

MAXIMUM CASE TEMPERATURE FOR SOLDERING PURPOSES:

260°C for 10 Seconds

POLARITY: Cathode indicated by polarity band

FLAMMABILITY RATING: UL 94 V-0

MAXIMUM RATINGS

Rating	Symbol	Max	Unit
Total Power Dissipation on FR-5 Board, (Note 1) @ $T_A = 25^\circ\text{C}$ Derated above 25°C	P_D	225 1.8	mW mW/°C
Thermal Resistance, Junction-to-Ambient	$R_{\theta JA}$	556	°C/W
Total Power Dissipation on Alumina Substrate, (Note 2) @ $T_A = 25^\circ\text{C}$ Derated above 25°C	P_D	300 2.4	mW mW/°C
Thermal Resistance, Junction-to-Ambient	$R_{\theta JA}$	417	°C/W
Junction and Storage Temperature Range	T_J, T_{stg}	-65 to +150	°C

Maximum ratings are those values beyond which device damage can occur. Maximum ratings applied to the device are individual stress limit values (not normal operating conditions) and are not valid simultaneously. If these limits are exceeded, device functional operation is not implied, damage may occur and reliability may be affected.

1. FR-5 = 1.0 X 0.75 X 0.62 in.
2. Alumina = 0.4 X 0.3 X 0.024 in, 99.5% alumina.



ON Semiconductor®

<http://onsemi.com>

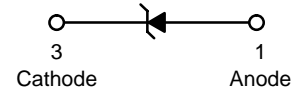

MARKING DIAGRAM

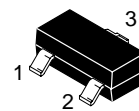

SOT-23
CASE 318
STYLE 8

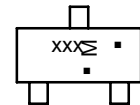

xxx = Specific Device Code

M = Date Code

■ = Pb-Free Package

(Note: Microdot may be in either location)

ORDERING INFORMATION

Device**	Package	Shipping†
MMBZ52xxBLT1	SOT-23	3000/Tape & Reel
MMBZ52xxBLT1G	SOT-23 (Pb-Free)	3000/Tape & Reel
MMBZ52xxBLT3	SOT-23	10,000/Tape & Reel
MMBZ52xxBLT3G	SOT-23 (Pb-Free)	10,000/Tape & Reel

**The "T1" suffix refers to an 8 mm, 7 inch reel.
The "T3" suffix refers to an 8 mm, 13 inch reel.

†For information on tape and reel specifications, including part orientation and tape sizes, please refer to our Tape and Reel Packaging Specifications Brochure, BRD8011/D.

DEVICE MARKING INFORMATION

See specific marking information in the device marking column of the Electrical Characteristics table on page 3 of this data sheet.

Devices listed in **bold, italic** are ON Semiconductor **Preferred** devices. **Preferred** devices are recommended choices for future use and best overall value.

MMBZ5221BLT1 Series

ELECTRICAL CHARACTERISTICS

(Pinout: 1-Anode, 2-No Connection, 3-Cathode) ($T_A = 25^\circ\text{C}$ unless otherwise noted, $V_F = 0.95\text{ V Max. @ } I_F = 10\text{ mA}$)

Symbol	Parameter
V_Z	Reverse Zener Voltage @ I_{ZT}
I_{ZT}	Reverse Current
Z_{ZT}	Maximum Zener Impedance @ I_{ZT}
I_{ZK}	Reverse Current
Z_{ZK}	Maximum Zener Impedance @ I_{ZK}
I_R	Reverse Leakage Current @ V_R
V_R	Reverse Voltage
I_F	Forward Current
V_F	Forward Voltage @ I_F

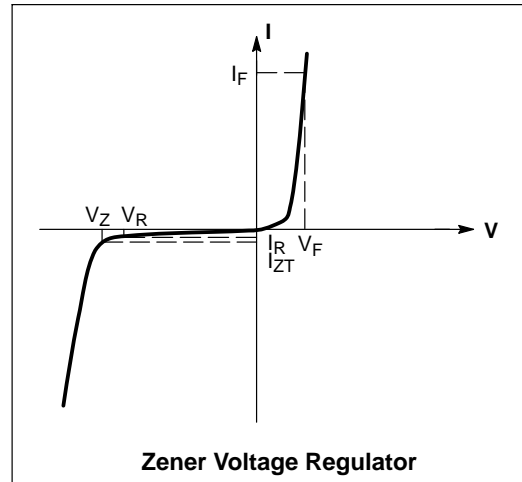

MMBZ5221BLT1 Series

ELECTRICAL CHARACTERISTICS (Pinout: 1-Anode, 2-NC, 3-Cathode) ($V_F = 0.9\text{ V Max @ } I_F = 10\text{ mA}$ for all types.)

Device	Device Marking	Zener Voltage (Note 3)			Zener Impedance			Leakage Current		
		V_Z (Volts)			@ I_{ZT}	Z_{ZT} @ I_{ZT}	Z_{ZK} @ I_{ZK}		I_R @ V_R	
		Min	Nom	Max	mA	Ω	Ω	mA	μA	Volts
MMBZ5221BL, G	18A	2.28	2.4	2.52	20	30	1200	0.25	100	1
MMBZ5222BL, G	18B	2.37	2.5	2.63	20	30	1250	0.25	100	1
MMBZ5223BL, G	18C	2.56	2.7	2.84	20	30	1300	0.25	75	1
MMBZ5224BL, G	18D	2.66	2.8	2.94	20	30	1400	0.25	75	1
MMBZ5225BL, G	18E	2.85	3	3.15	20	29	1600	0.25	50	1
MMBZ5226BL, G	8A	3.13	3.3	3.47	20	28	1600	0.25	25	1
MMBZ5227BL, G	8B	3.42	3.6	3.78	20	24	1700	0.25	15	1
MMBZ5228BL, G	8C	3.70	3.9	4.10	20	23	1900	0.25	10	1
MMBZ5229BL, G	8D	4.08	4.3	4.52	20	22	2000	0.25	5	1
MMBZ5230BL, G	8E	4.46	4.7	4.94	20	19	1900	0.25	5	2
MMBZ5231BL, G	8F	4.84	5.1	5.36	20	17	1600	0.25	5	2
MMBZ5232BL, G	8G	5.32	5.6	5.88	20	11	1600	0.25	5	3
MMBZ5233BL, G	8H	5.70	6	6.30	20	7	1600	0.25	5	3.5
MMBZ5234BL, G	8J	5.89	6.2	6.51	20	7	1000	0.25	5	4
MMBZ5235BL, G	8K	6.46	6.8	7.14	20	5	750	0.25	3	5
MMBZ5236BL, G	8L	7.12	7.5	7.88	20	6	500	0.25	3	6
MMBZ5237BL, G	8M	7.79	8.2	8.61	20	8	500	0.25	3	6.5
MMBZ5238BL, G	8N	8.26	8.7	9.14	20	8	600	0.25	3	6.5
MMBZ5239BL, G	8P	8.64	9.1	9.56	20	10	600	0.25	3	7
MMBZ5240BL, G	8Q	9.50	10	10.50	20	17	600	0.25	3	8
MMBZ5241BL, G	8R	10.4	11	11.55	20	22	600	0.25	2	8.4
MMBZ5242BL, G	8S	11.40	12	12.60	20	30	600	0.25	1	9.1
MMBZ5243BL, G	8T	12.35	13	13.65	9.5	13	600	0.25	0.5	9.9
MMBZ5244BL, G	8U	13.30	14	14.70	9	15	600	0.25	0.1	10
MMBZ5245BL, G	8V	14.25	15	15.75	8.5	16	600	0.25	0.1	11
MMBZ5246BL, G	8W	15.20	16	16.80	7.8	17	600	0.25	0.1	12
MMBZ5247BL, G	8X	16.15	17	17.85	7.4	19	600	0.25	0.1	13
MMBZ5248BL, G	8Y	17.10	18	18.90	7	21	600	0.25	0.1	14
MMBZ5249BL, G	8Z	18.05	19	19.95	6.6	23	600	0.25	0.1	14
MMBZ5250BL, G	81A	19.00	20	21.00	6.2	25	600	0.25	0.1	15
MMBZ5251BL, G	81B	20.90	22	23.10	5.6	29	600	0.25	0.1	17
MMBZ5252BL, G	81C	22.80	24	25.20	5.2	33	600	0.25	0.1	18
MMBZ5253BL, G	81D	23.75	25	26.25	5	35	600	0.25	0.1	19
MMBZ5254BL, G	81E	25.65	27	28.35	4.6	41	600	0.25	0.1	21
MMBZ5255BL, G	81F	26.60	28	29.40	4.5	44	600	0.25	0.1	21
MMBZ5256BL, G	81G	28.50	30	31.50	4.2	49	600	0.25	0.1	23
MMBZ5257BL, G	81H	31.35	33	34.65	3.8	58	700	0.25	0.1	25
MMBZ5258BL, G	81J	34.20	36	37.80	3.4	70	700	0.25	0.1	27
MMBZ5259BL, G	81K	37.05	39	40.95	3.2	80	800	0.25	0.1	30
MMBZ5260BL, G	81L	40.85	43	45.15	3	93	900	0.25	0.1	33
MMBZ5261BL, G	81M	44.65	47	49.35	2.7	105	1000	0.25	0.1	36
MMBZ5262BL, G	81N	48.45	51	53.55	2.5	125	1100	0.25	0.1	39
MMBZ5263BL, G	81P	53.20	56	58.80	2.2	150	1300	0.25	0.1	43
MMBZ5264BL, G	81Q	57.00	60	63.00	2.1	170	1400	0.25	0.1	46
MMBZ5265BL, G	81R	58.90	62	65.10	2	185	1400	0.25	0.1	47
MMBZ5266BL, G	81S	64.60	68	71.40	1.8	230	1600	0.25	0.1	52
MMBZ5267BL, G	81T	71.25	75	78.75	1.7	270	1700	0.25	0.1	56
MMBZ5268BL, G	81U	77.90	82	86.10	1.5	330	2000	0.25	0.1	62
MMBZ5270BL, G	81W	86.45	91	95.55	1.4	400	2300	0.25	0.1	69

3. Zener voltage is measured with a pulse test current I_Z at an ambient temperature of 25°C

NOTE: MMBZ5233BLT1, MMBZ5246BLT1, MMBZ5251BLT1, and MMBZ5252BLT1 Not Available in 10,000/Tape & Reel.

†The "G" suffix indicates Pb-Free package available.

MMBZ5221BLT1 Series

TYPICAL CHARACTERISTICS

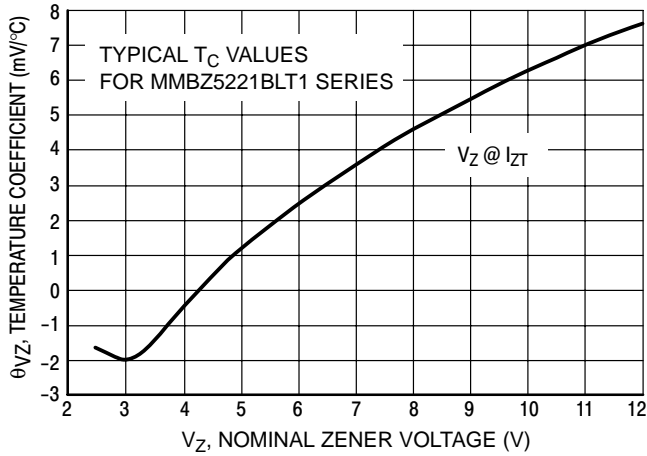

**Figure 1. Temperature Coefficients
(Temperature Range -55°C to +150°C)**

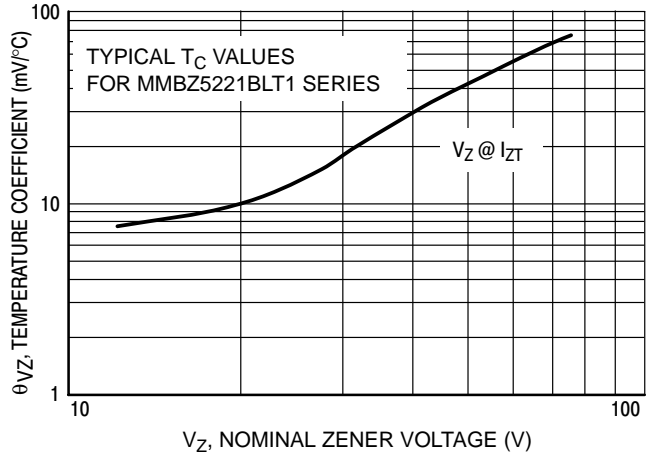

**Figure 2. Temperature Coefficients
(Temperature Range -55°C to +150°C)**

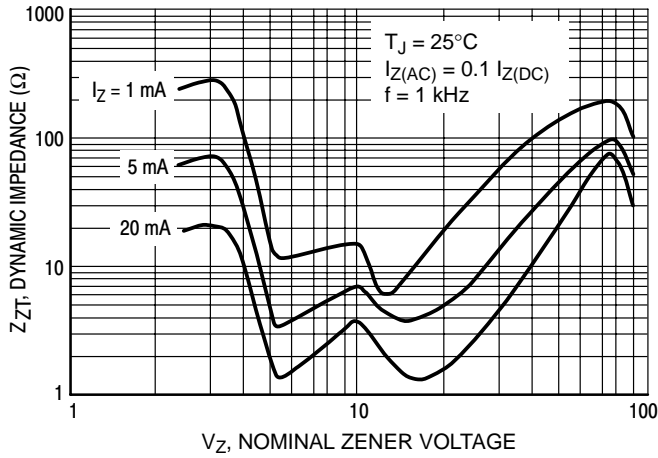

**Figure 3. Effect of Zener Voltage on
Zener Impedance**

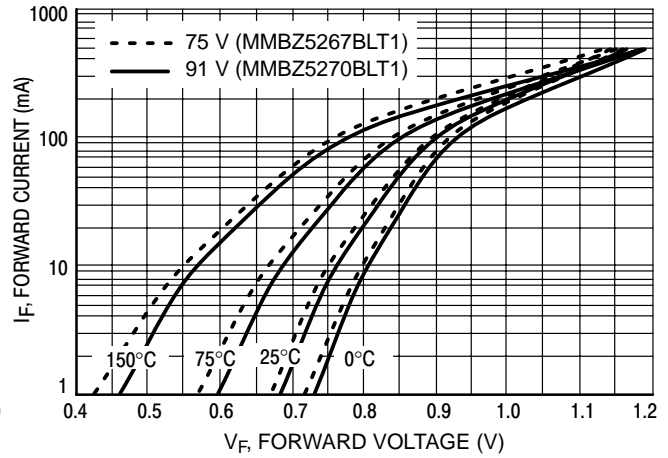

Figure 4. Typical Forward Voltage

MMBZ5221BLT1 Series

TYPICAL CHARACTERISTICS

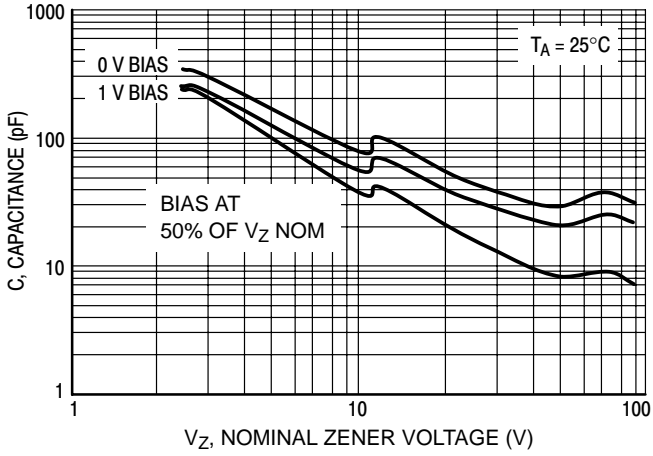

Figure 5. Typical Capacitance

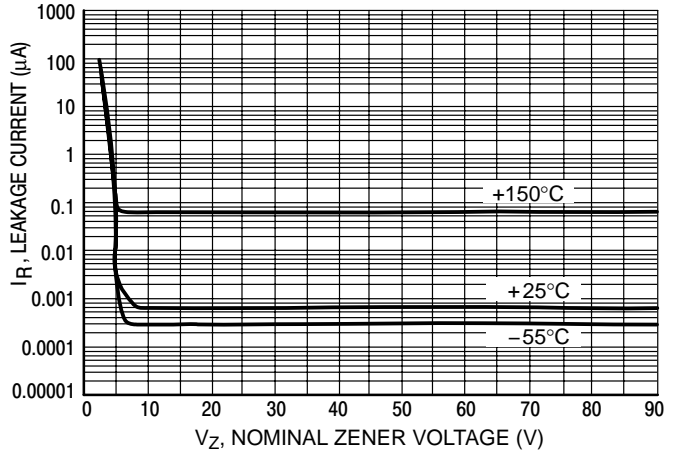

Figure 6. Typical Leakage Current

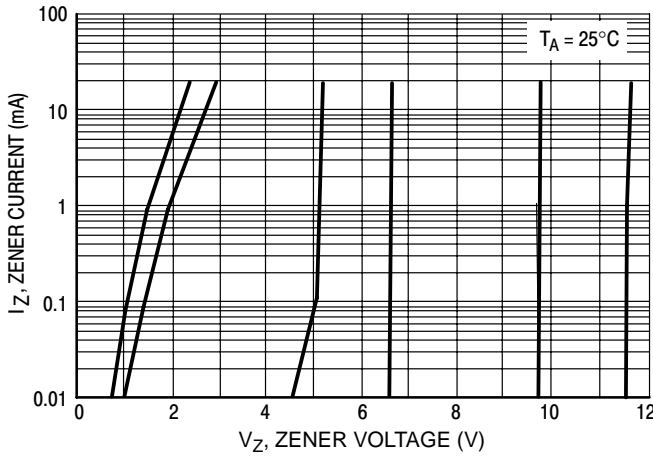

Figure 7. Zener Voltage versus Zener Current (V_Z Up to 12 V)

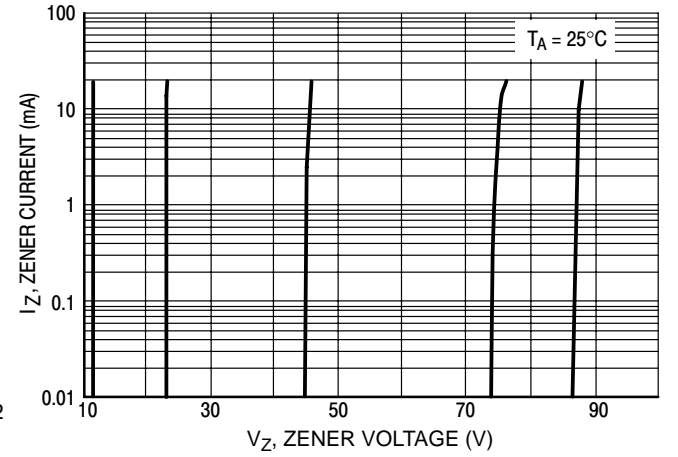
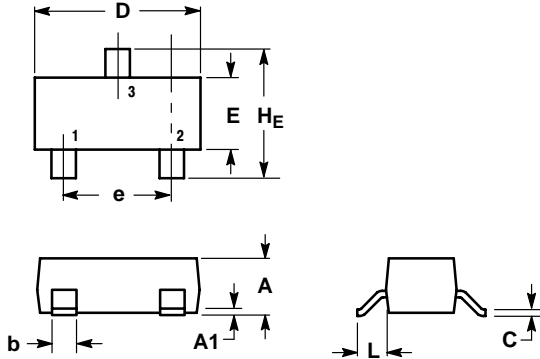

Figure 8. Zener Voltage versus Zener Current (12 V to 91 V)

MMBZ5221BLT1 Series

PACKAGE DIMENSIONS

SOT-23 (TO-236)
CASE 318-08
ISSUE AL



NOTES:

1. DIMENSIONING AND TOLERANCING PER ANSI Y14.5M, 1982.
2. CONTROLLING DIMENSION: INCH.
3. MAXIMUM LEAD THICKNESS INCLUDES LEAD FINISH THICKNESS. MINIMUM LEAD THICKNESS IS THE MINIMUM THICKNESS OF BASE MATERIAL.
4. 318-01 THRU -07 AND -09 OBSOLETE, NEW STANDARD 318-08.

DIM	MILLIMETERS			INCHES		
	MIN	NOM	MAX	MIN	NOM	MAX
A	0.89	1.00	1.11	0.035	0.040	0.044
A1	0.01	0.06	0.10	0.001	0.002	0.004
b	0.37	0.44	0.50	0.015	0.018	0.020
c	0.09	0.13	0.18	0.003	0.005	0.007
D	2.80	2.90	3.04	0.110	0.114	0.120
E	1.20	1.30	1.40	0.047	0.051	0.055
e	1.78	1.90	2.04	0.070	0.075	0.081
L	0.35	0.54	0.69	0.014	0.021	0.029
H _E	2.10	2.40	2.64	0.083	0.094	0.104

SOLDERING FOOTPRINT*

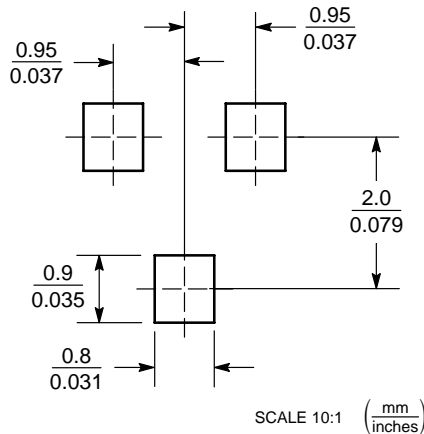

*For additional information on our Pb-Free strategy and soldering details, please download the ON Semiconductor Soldering and Mounting Techniques Reference Manual, SOLDERRM/D.

ON Semiconductor and are registered trademarks of Semiconductor Components Industries, LLC (SCILLC). SCILLC reserves the right to make changes without further notice to any products herein. SCILLC makes no warranty, representation or guarantee regarding the suitability of its products for any particular purpose, nor does SCILLC assume any liability arising out of the application or use of any product or circuit, and specifically disclaims any and all liability, including without limitation special, consequential or incidental damages. "Typical" parameters which may be provided in SCILLC data sheets and/or specifications can and do vary in different applications and actual performance may vary over time. All operating parameters, including "Typicals" must be validated for each customer application by customer's technical experts. SCILLC does not convey any license under its patent rights nor the rights of others. SCILLC products are not designed, intended, or authorized for use as components in systems intended for surgical implant into the body, or other applications intended to support or sustain life, or for any other application in which the failure of the SCILLC product could create a situation where personal injury or death may occur. Should Buyer purchase or use SCILLC products for any such unintended or unauthorized application, Buyer shall indemnify and hold SCILLC and its of r i s . 5 (