

KSR Series Subminiature Tact Switch for SMT

Features/Benefits

- Saves PCB space
- Range of 4 actuation forces
- J or G terminations
- N.O. or N.C. contacts
- Detect type available
- Soft actuator

Typical Applications

- Automotive
- Cellular phones & accessories
- Industrial electronics
- Computers & network equipment



B

Tactile Switches

Specification

FUNCTION: momentary action
CONTACT ARRANGEMENT: N.O.
TERMINALS: J bend & Gullwing type for SMT

Mechanical

Type	Operating force Newtons (grams)	Operating life (operations)	Travel
KSR211/213	1.2 (120) ± 30%	100,000	0,3 ± 0,15
KSR221/223	2.0 (200) ± 25%	200,000	0,5 ± 0,15
KSR231/233	3.0 (300) ± 25%	200,000	0,5 ± 0,15
KSR251/253	4.5 (450) ± 25%	100,000	0,5 ± 0,15
KSR2D3J	1.5 (150) ± 25%	100,000	0,3 ± 0,15
KSR223GNC	2 (200) ± 25%	100,000	0,3 ± 0,15

Packaging

Switches are delivered on continuous tape, in reels of 2,500 pieces.

Electrical

	Silver	Gold
MAXIMUM POWER:	1 VA	0.2 VA
MAXIMUM VOLTAGE:	50 VDC	50 VDC
MINIMUM VOLTAGE:	20 mV	20 mV
MAXIMUM CURRENT DC:	50 mA	10 mA
MINIMUM CURRENT DC:	1 mA	1 mA

CONTACT RESISTANCE: ≤ 100 mΩ
INSULATION RESISTANCE (100 V): 10⁹ Ω
BOUNCE TIME: 1 ms

Environmental

	Silver	Gold
OPERATING TEMPERATURE:	-40°C to 85°C	-40°C to 125°C
STORAGE TEMPERATURE:	-55°C to 85°C	-55°C to 125°C

Process

SOLDERING: Infrared reflow in accordance with CECC00802

NOTE: Part numbers listed above do not represent all possible configurations. For information on specific and custom switches, consult Customer Service Center.

How To Order

Our easy build-a-switch concept allows you to mix and match options to create the switch you need. To order, select desired option from each category and place it in the appropriate box.

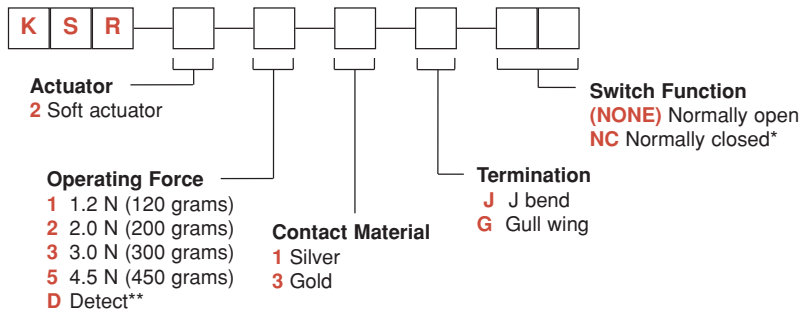

*Available on KSR223GNC only.

**D contact is recommended for long period of closing. No tactile feel. KSR2D3J only.

KSR Series Subminiature Tact Switch for SMT

SERIES

KSR

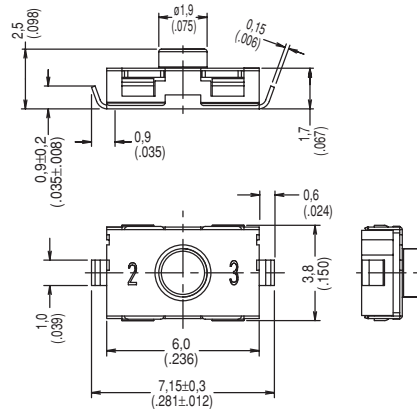

B

Tactile Switches

ACTUATOR

2 Soft Actuator

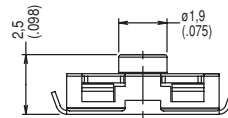

OPERATING FORCE

OPTION CODE	OPERATING FORCE
1	1.2 N (120 grams)
2	2.0 N (200 grams)
3	3.0 N (300 grams)
5	4.0 N (400 grams)
D*	DETECT

*D contact is recommended for long period of closing.
No tactile feel. KSR2D3J only.

CONTACT MATERIAL

OPTION CODE	MATERIAL
1	SILVER
3	GOLD



First Angle
Projection

Dimensions are shown: mm (inch)
Dimensions subject to change

KSR Series Subminiature Tact Switch for SMT

TERMINATION

J J BEND

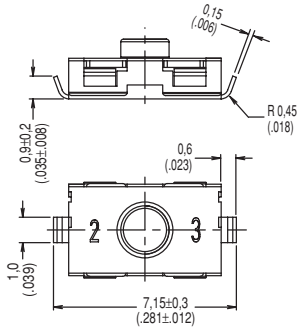

G GULLWING

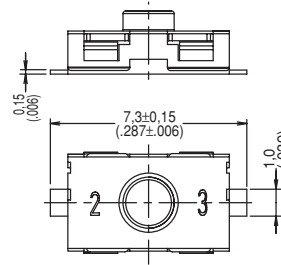

PAD LAYOUT

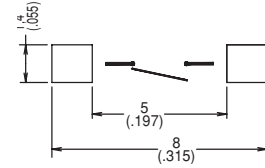

SWITCH FUNCTION

OPTION CODE	FUNCTION
NONE	NORMALLY OPEN
NC*	NORMALLY CLOSED

*Available on KSR223GNC only.

TAPE & REEL

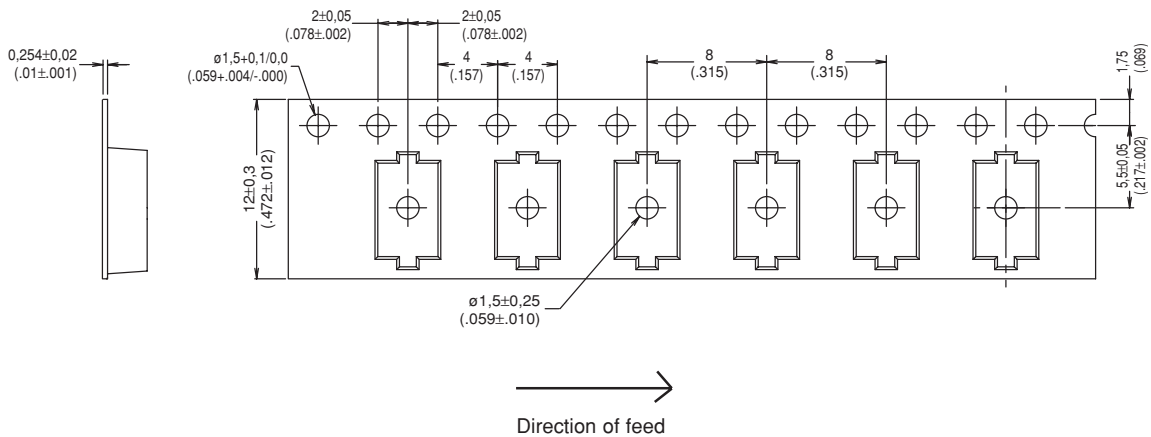

First Angle
Projection

Dimensions are shown: mm (inch)
Dimensions subject to change