

# MAC16D, MAC16M, MAC16N

Preferred Device

## Triacs

### Silicon Bidirectional Thyristors

Designed for high performance full-wave ac control applications where high noise immunity and high commutating di/dt are required.

- Blocking Voltage to 800 Volts
- On-State Current Rating of 15 Amperes RMS at 80°C
- Uniform Gate Trigger Currents in Three Quadrants
- High Immunity to dv/dt — 500 V/μs minimum at 125°C
- Minimizes Snubber Networks for Protection
- Industry Standard TO-220AB Package
- High Commutating di/dt — 9.0 A/ms minimum at 125°C
- Device Marking: Logo, Device Type, e.g., MAC16D, Date Code

#### MAXIMUM RATINGS (T<sub>J</sub> = 25°C unless otherwise noted)

Rating	Symbol	Value	Unit
Peak Repetitive Off-State Voltage <sup>(1)</sup> (T <sub>J</sub> = -40 to 125°C, Sine Wave, 50 to 60 Hz, Gate Open)	V <sub>DRM</sub> , V <sub>RRM</sub>		Volts
MAC16D		400	
MAC16M		600	
MAC16N		800	
On-State RMS Current (Full Cycle Sine Wave, 60 Hz, T <sub>C</sub> = 80°C)	I <sub>T(RMS)</sub>	15	Amps
Peak Non-Repetitive Surge Current (One Full Cycle Sine Wave, 60 Hz, T <sub>J</sub> = 125°C)	I <sub>TSM</sub>	150	Amps
Circuit Fusing Consideration (t = 8.3 ms)	I <sup>2</sup> t	93	A <sup>2</sup> sec
Peak Gate Power (Pulse Width ≤ 1.0 μs, T <sub>C</sub> = 80°C)	P <sub>GM</sub>	20	Watts
Average Gate Power (t = 8.3 ms, T <sub>C</sub> = 80°C)	P <sub>G(AV)</sub>	0.5	Watt
Operating Junction Temperature Range	T <sub>J</sub>	-40 to +125	°C
Storage Temperature Range	T <sub>stg</sub>	-40 to +150	°C

(1) V<sub>DRM</sub> and V<sub>RRM</sub> for all types can be applied on a continuous basis. Blocking voltages shall not be tested with a constant current source such that the voltage ratings of the devices are exceeded.



**ON Semiconductor**

<http://onsemi.com>

**TRIACS**  
**15 AMPERES RMS**  
**400 thru 800 VOLTS**

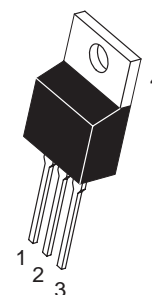
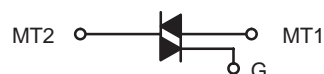

**TO-220AB**  
**CASE 221A**  
**STYLE 4**

PIN ASSIGNMENT	
1	Main Terminal 1
2	Main Terminal 2
3	Gate
4	Main Terminal 2

#### ORDERING INFORMATION

Device	Package	Shipping
MAC16D	TO220AB	50 Units/Rail
MAC16M	TO220AB	50 Units/Rail
MAC16N	TO220AB	50 Units/Rail

Preferred devices are recommended choices for future use and best overall value.

# MAC16D, MAC16M, MAC16N

## THERMAL CHARACTERISTICS

Characteristic	Symbol	Value	Unit
Thermal Resistance — Junction to Case — Junction to Ambient	$R_{\theta JC}$ $R_{\theta JA}$	2.0 62.5	$^{\circ}C/W$
Maximum Lead Temperature for Soldering Purposes 1/8" from Case for 10 Seconds	$T_L$	260	$^{\circ}C$

## ELECTRICAL CHARACTERISTICS ( $T_J = 25^{\circ}C$ unless otherwise noted; Electricals apply in both directions)

Characteristic	Symbol	Min	Typ	Max	Unit
----------------	--------	-----	-----	-----	------

## OFF CHARACTERISTICS

Peak Repetitive Blocking Current ( $V_D = \text{Rated } V_{DRM}, V_{RRM}$ ; Gate Open)	$I_{DRM}$ $I_{RRM}$	— —	— —	0.01 2.0	mA

## ON CHARACTERISTICS

Peak On-State Voltage* ( $I_{TM} = \pm 21$ A Peak)	$V_{TM}$	—	1.2	1.6	Volts
Gate Trigger Current (Continuous dc) ( $V_D = 12$ V, $R_L = 100 \Omega$ ) MT2(+), G(+) MT2(+), G(-) MT2(-), G(-)	$I_{GT}$	10 10 10	16 18 22	50 50 50	mA
Holding Current ( $V_D = 12$ V, Gate Open, Initiating Current = $\pm 150$ mA)	$I_H$	—	20	50	mA
Latching Current ( $V_D = 24$ V, $I_G = 50$ mA) MT2(+), G(+) MT2(+), G(-) MT2(-), G(-)	$I_L$	— — —	33 36 33	50 80 50	mA
Gate Trigger Voltage ( $V_D = 12$ V, $R_L = 100 \Omega$ ) MT2(+), G(+) MT2(+), G(-) MT2(-), G(-)	$V_{GT}$	0.5 0.5 0.5	0.75 0.72 0.82	1.5 1.5 1.5	Volts

## DYNAMIC CHARACTERISTICS

Rate of Change of Commutating Current, See Figure 10. ( $V_D = 400$ V, $I_{TM} = 6.0$ A, Commutating $dv/dt = 24$ V/ $\mu$ s, Gate Open, $T_J = 125^{\circ}C$ , $f = 250$ Hz, No Snubber) $C_L = 10 \mu F$ $L_L = 40$ mH	$(di/dt)_C$	9.0	—	—	A/ms
Critical Rate of Rise of Off-State Voltage ( $V_D = \text{Rated } V_{DRM}$ , Exponential Waveform, Gate Open, $T_J = 125^{\circ}C$ )	$dv/dt$	500	—	—	V/ $\mu$ s

\*Indicates Pulse Test: Pulse Width  $\leq 2.0$  ms, Duty Cycle  $\leq 2\%$ .

# MAC16D, MAC16M, MAC16N

## Voltage Current Characteristic of Triacs (Bidirectional Device)

Symbol	Parameter
$V_{DRM}$	Peak Repetitive Forward Off State Voltage
$I_{DRM}$	Peak Forward Blocking Current
$V_{RRM}$	Peak Repetitive Reverse Off State Voltage
$I_{RRM}$	Peak Reverse Blocking Current
$V_{TM}$	Maximum On State Voltage
$I_H$	Holding Current

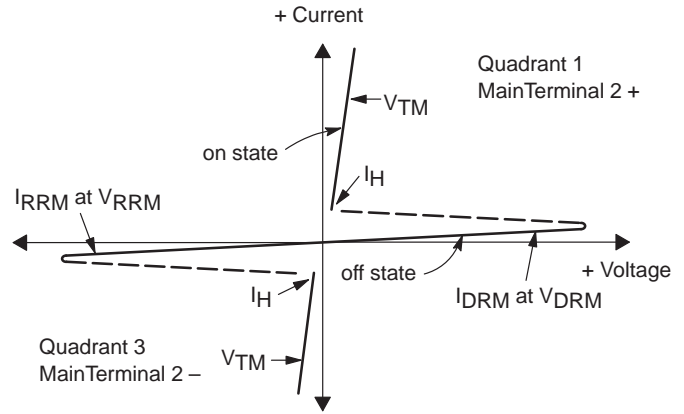

### Quadrant Definitions for a Triac

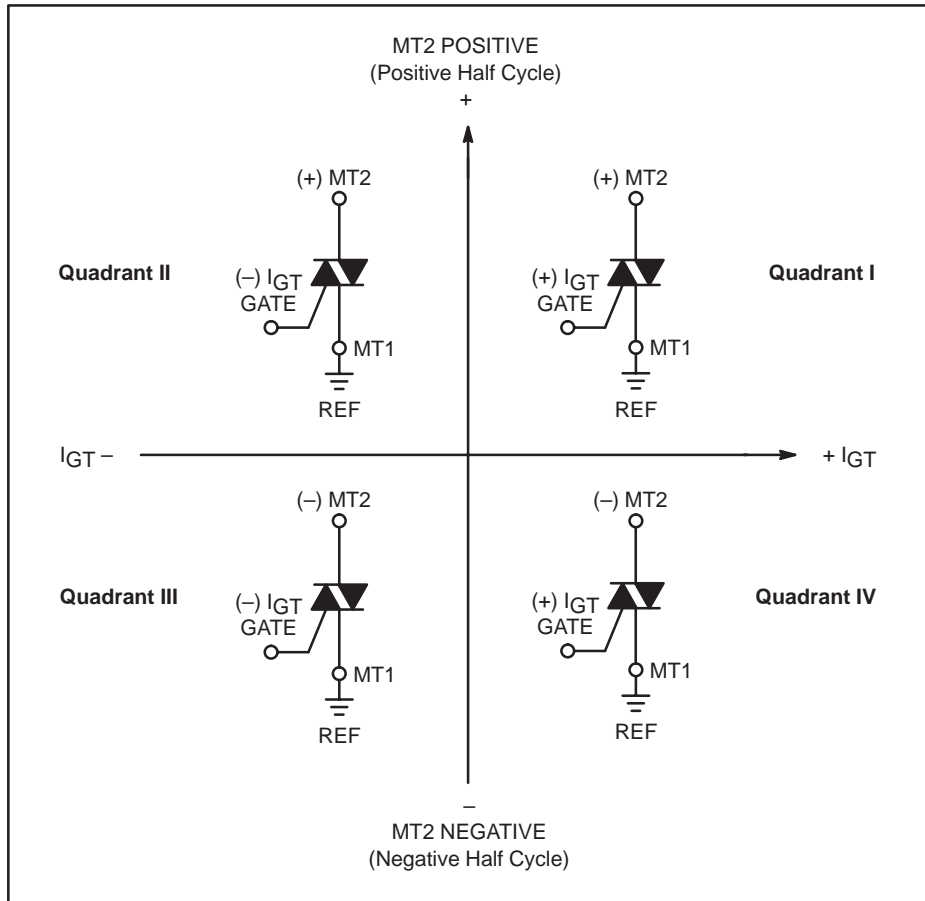

All polarities are referenced to MT1.  
With in-phase signals (using standard AC lines) quadrants I and III are used.

# MAC16D, MAC16M, MAC16N

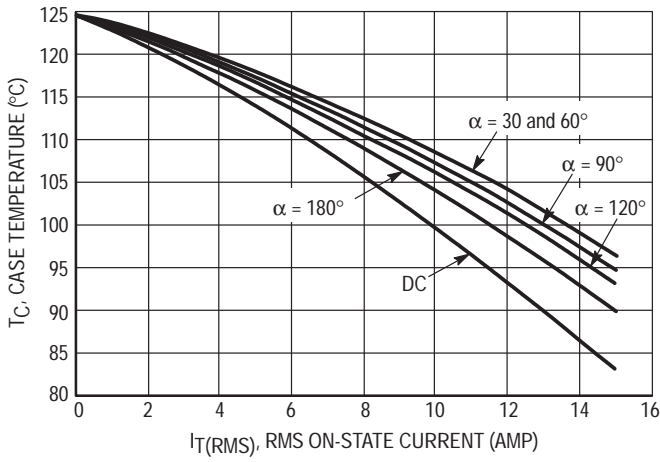

Figure 1. RMS Current Derating

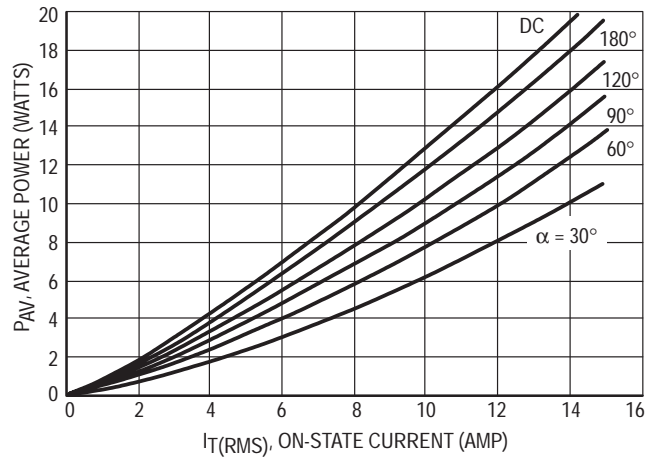

Figure 2. On-State Power Dissipation

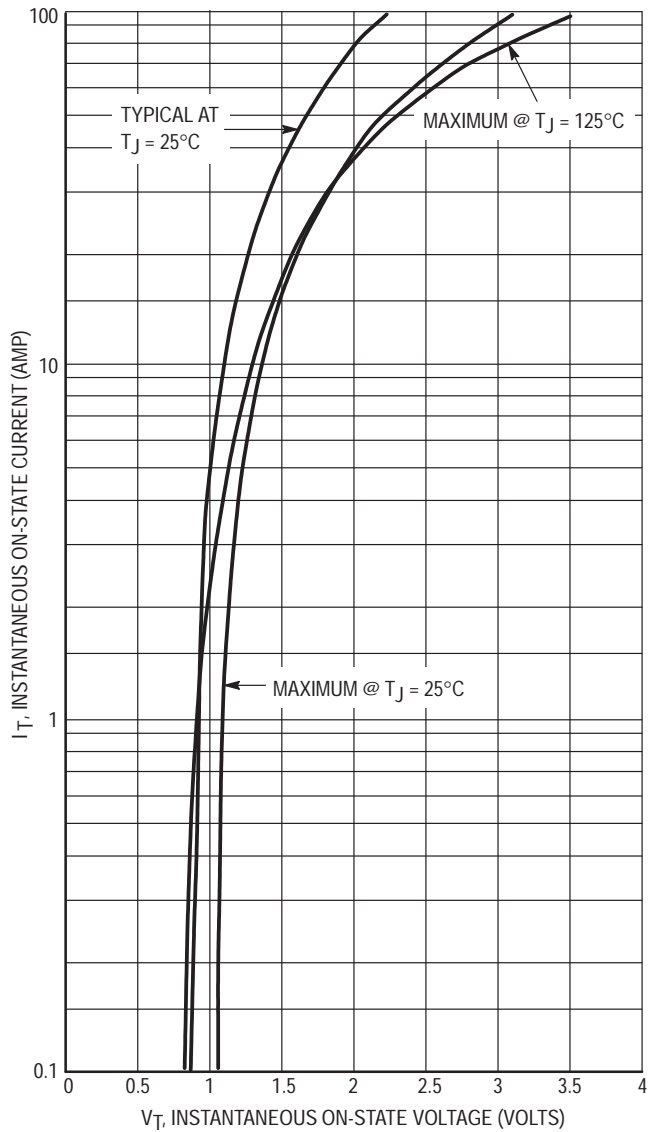

Figure 3. On-State Characteristics

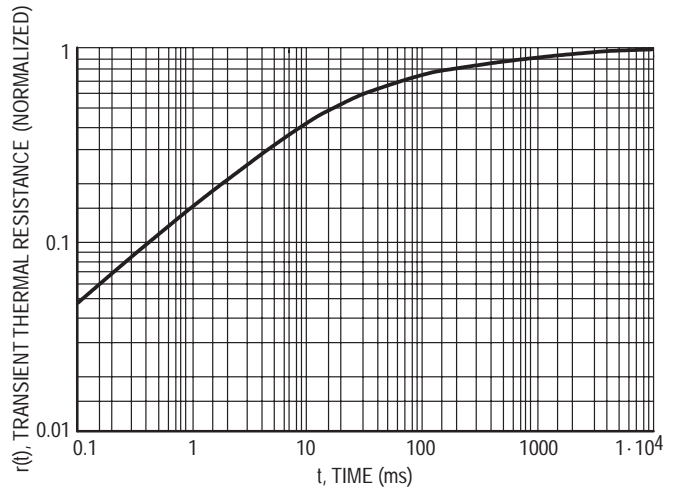

Figure 4. Thermal Response

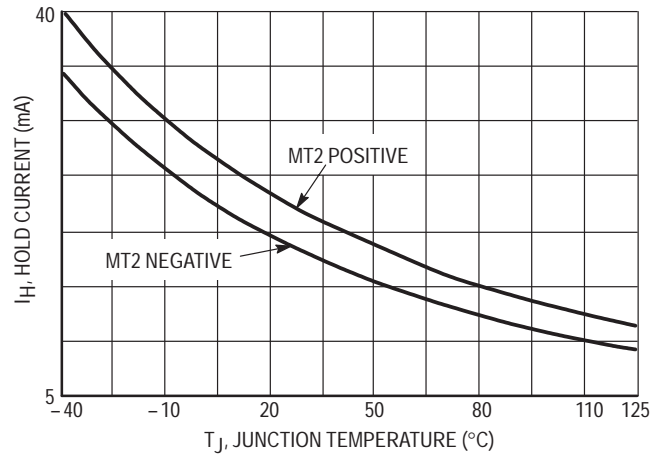

Figure 5. Hold Current Variation

# MAC16D, MAC16M, MAC16N

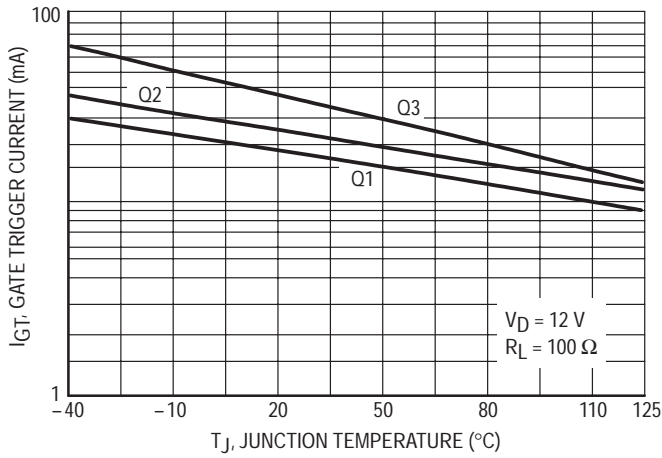

Figure 6. Gate Trigger Current Variation

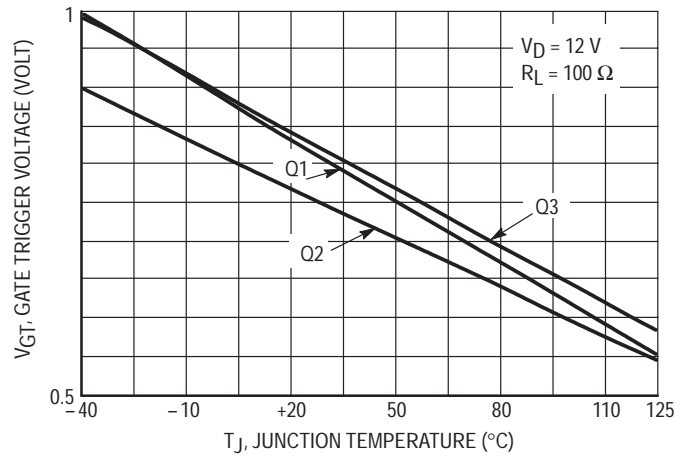

Figure 7. Gate Trigger Voltage Variation

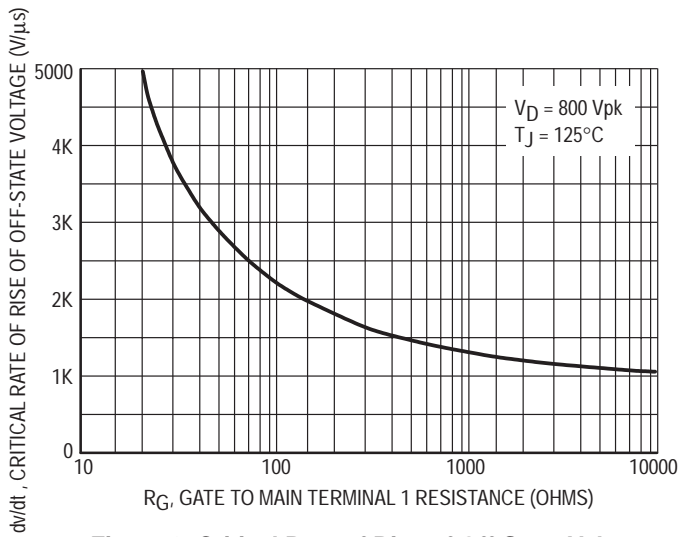

Figure 8. Critical Rate of Rise of Off-State Voltage (Exponential Waveform)

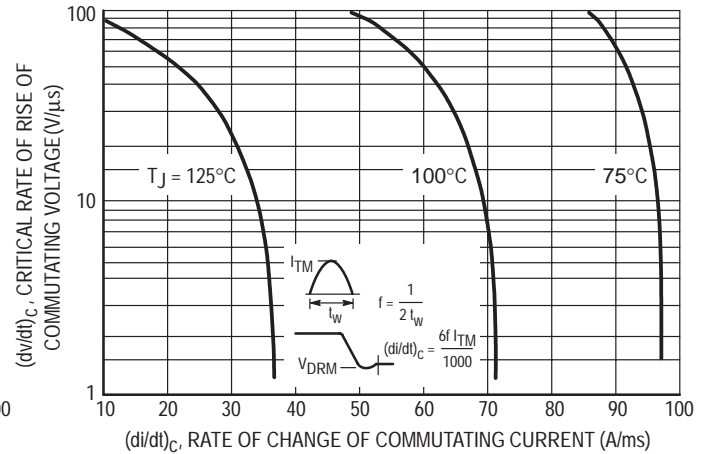
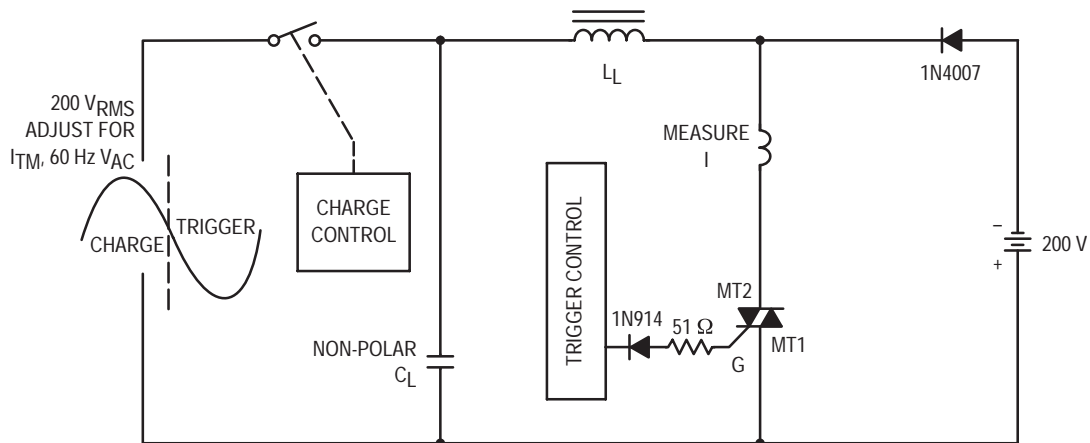

Figure 9. Critical Rate of Rise of Commutating Voltage



Note: Component values are for verification of rated  $(di/dt)_c$ . See AN1048 for additional information.

Figure 10. Simplified Test Circuit to Measure the Critical Rate of Rise of Commutating Current  $(di/dt)_c$

# MAC16D, MAC16M, MAC16N

## PACKAGE DIMENSIONS

TO-220AB  
CASE 221A-09  
ISSUE Z

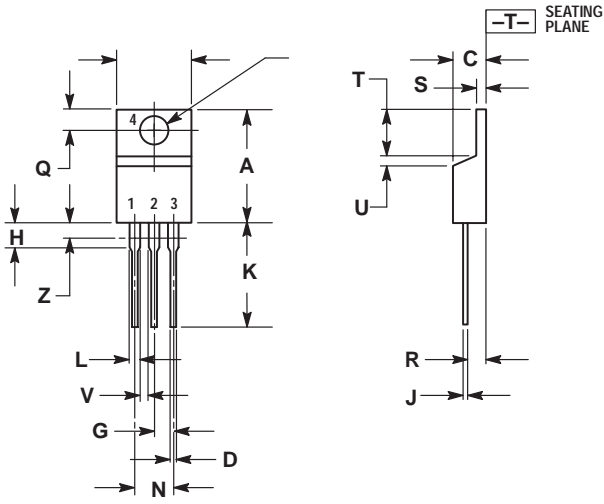

- NOTES:
1. DIMENSIONING AND TOLERANCING PER ANSI Y14.5M, 1982.
  2. CONTROLLING DIMENSION: INCH.
  3. DIMENSION Z DEFINES A ZONE WHERE ALL BODY AND LEAD IRREGULARITIES ARE ALLOWED.

DIM	INCHES		MILLIMETERS	
	MIN	MAX	MIN	MAX
A	0.570	0.620	14.48	15.75
B	0.380	0.405	9.66	10.28
C	0.160	0.190	4.07	4.82
D	0.025	0.035	0.64	0.88
F	0.142	0.147	3.61	3.73
G	0.095	0.105	2.42	2.66
H	0.110	0.155	2.80	3.93
J	0.018	0.025	0.46	0.64
K	0.500	0.562	12.70	14.27
L	0.045	0.060	1.15	1.52
N	0.190	0.210	4.83	5.33
Q	0.100	0.120	2.54	3.04
R	0.080	0.110	2.04	2.79
S	0.045	0.055	1.15	1.39
T	0.235	0.255	5.97	6.47
U	0.000	0.050	0.00	1.27
V	0.045	---	1.15	---
Z	---	0.080	---	2.04

- STYLE 4:  
PIN 1. MAIN TERMINAL 1  
2. MAIN TERMINAL 2  
3. GATE  
4. MAIN TERMINAL 2

## Notes

# MAC16D, MAC16M, MAC16N

**ON Semiconductor** and  are trademarks of Semiconductor Components Industries, LLC (SCILLC). SCILLC reserves the right to make changes without further notice to any products herein. SCILLC makes no warranty, representation or guarantee regarding the suitability of its products for any particular purpose, nor does SCILLC assume any liability arising out of the application or use of any product or circuit, and specifically disclaims any and all liability, including without limitation special, consequential or incidental damages. "Typical" parameters which may be provided in SCILLC data sheets and/or specifications can and do vary in different applications and actual performance may vary over time. All operating parameters, including "Typicals" must be validated for each customer application by customer's technical experts. SCILLC does not convey any license under its patent rights nor the rights of others. SCILLC products are not designed, intended, or authorized for use as components in systems intended for surgical implant into the body, or other applications intended to support or sustain life, or for any other application in which the failure of the SCILLC product could create a situation where personal injury or death may occur. Should Buyer purchase or use SCILLC products for any such unintended or unauthorized application, Buyer shall indemnify and hold SCILLC and its officers, employees, subsidiaries, affiliates, and distributors harmless against all claims, costs, damages, and expenses, and reasonable attorney fees arising out of, directly or indirectly, any claim of personal injury or death associated with such unintended or unauthorized use, even if such claim alleges that SCILLC was negligent regarding the design or manufacture of the part. SCILLC is an Equal Opportunity/Affirmative Action Employer.

## PUBLICATION ORDERING INFORMATION

### **NORTH AMERICA Literature Fulfillment:**

Literature Distribution Center for ON Semiconductor  
P.O. Box 5163, Denver, Colorado 80217 USA  
**Phone:** 303-675-2175 or 800-344-3860 Toll Free USA/Canada  
**Fax:** 303-675-2176 or 800-344-3867 Toll Free USA/Canada  
**Email:** ONlit@hibbertco.com  
Fax Response Line: 303-675-2167 or 800-344-3810 Toll Free USA/Canada

**N. American Technical Support:** 800-282-9855 Toll Free USA/Canada

**EUROPE:** LDC for ON Semiconductor – European Support

**German Phone:** (+1) 303-308-7140 (M-F 1:00pm to 5:00pm Munich Time)  
**Email:** ONlit-german@hibbertco.com  
**French Phone:** (+1) 303-308-7141 (M-F 1:00pm to 5:00pm Toulouse Time)  
**Email:** ONlit-french@hibbertco.com  
**English Phone:** (+1) 303-308-7142 (M-F 12:00pm to 5:00pm UK Time)  
**Email:** ONlit@hibbertco.com

**EUROPEAN TOLL-FREE ACCESS\*: 00-800-4422-3781**

\*Available from Germany, France, Italy, England, Ireland

### **CENTRAL/SOUTH AMERICA:**

**Spanish Phone:** 303-308-7143 (Mon-Fri 8:00am to 5:00pm MST)  
**Email:** ONlit-spanish@hibbertco.com

**ASIA/PACIFIC:** LDC for ON Semiconductor – Asia Support

**Phone:** 303-675-2121 (Tue-Fri 9:00am to 1:00pm, Hong Kong Time)  
Toll Free from Hong Kong & Singapore:  
**001-800-4422-3781**  
**Email:** ONlit-asia@hibbertco.com

**JAPAN:** ON Semiconductor, Japan Customer Focus Center  
4-32-1 Nishi-Gotanda, Shinagawa-ku, Tokyo, Japan 141-8549  
**Phone:** 81-3-5740-2745  
**Email:** r14525@onsemi.com

**ON Semiconductor Website:** <http://onsemi.com>

For additional information, please contact your local Sales Representative.