

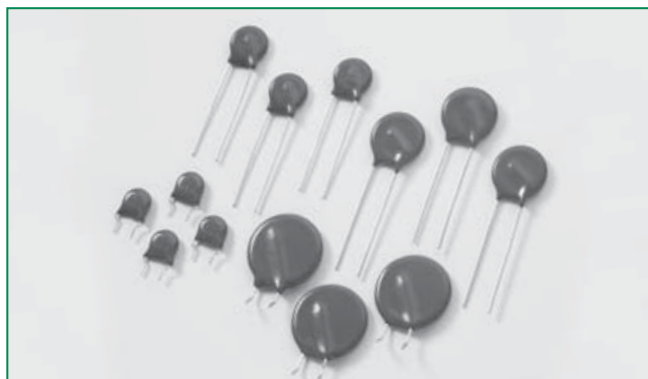



RoHS (Pb) UltraMOV™ Varistor Series

Description

The UltraMOV™ Metal Oxide Varistor Series is designed for applications requiring high peak surge current ratings and high energy absorption capability. UltraMOV™ varistors are primarily intended for use in AC Line Voltage applications such as Transient Voltage Surge Suppressors (TVSS), Uninterruptable Power Supplies (UPS), AC Power Taps, AC Power Meters, or other products that require voltage clamping of high transient surge currents from sources such as lightning, inductive load switching, or capacitor bank switching.

These devices are produced in radial lead package sizes of 7, 10, 14 and 20mm and offered in a variety of lead forms. UltraMOV™s are manufactured with recognized epoxy encapsulation and are rated for ambient temperatures up to 85°C with no derating. This Series is LASER-branded and is supplied in bulk, ammo pack (fan-fold), or tape and reel packaging.

Agency Approvals

Agency	Agency File Number
	E320116
	116895E
	LR91788
	42201-006

Features

- Lead-free and RoHS compliant option available. Please see the device and ratings specifications table for more information
- High peak surge current rating (I_{TM}) up to 10kA, single 8 x 20 pulse, (20mm)
- Standard operating voltage range compatible with common AC line voltages (130 V_{AC} to 625 V_{AC})
- Characterized for maximum standby current (Leakage)
- Custom voltage types available
- Standard lead form and lead space options

ULTRAMOV™ Series
Absolute Maximum Ratings

• For ratings of individual members of a series, see Device Ratings and Specifications chart

Continuous	UltraMOV™ Series	Units
Steady State Applied Voltage:		
DC Voltage Range ($V_{M(AC)RMS}$)	130 to 625	V
Transients:		
Single-Pulse Peak Current (I_{TM}) 8x20 μ s Wave (See Figure 2)	1,750 to 10,000	A
Single-Pulse Energy Range (W_{TM}) 2ms Square Wave	12.5 to 400	J
Operating Ambient Temperature Range (T_A)	-55 to +85	°C
Storage Temperature Range (T_{STG})	-55 to +125	°C
Temperature Coefficient (α^V) of Clamping Voltage (V_C) at Specified Test Current	<0.01	%/°C
Hi-Pot Encapsulation (COATING Isolation Voltage Capability)	2500	V
COATING Insulation Resistance	1000	M Ω

CAUTION: Stresses above those listed in "Absolute Maximum Ratings" may cause permanent damage to the device. This is a stress only rating and operation of the device at these or any other conditions above those indicated in the operational sections of this specification is not implied.

UltraMOV™ Series Ratings & Specifications

Lead-free and RoHS Compliant Models		Standard Models		Maximum Rating (85°C)					Specifications (25°C)				
				Continuous		Transient			Varistor Voltage at 1mA DC Test Current		Maximum Clamping Voltage 8 x 20µs		Typical Capacitance
				RMS Volts	DC Volts	Energy 2ms	Peak Current 8 x 20µs						
Part Number	Branding	Part Number	Branding	V _{M(AC)} (V)	V _{M(DC)} (V)	W _{TM} (J)	I _{TM} 1 x Pulse (A)	I _{TM} 2 x Pulse (A)	V _{NOM} Min (V)	V _{NOM} Max (V)	V _C (V)	I _{PK} (A)	f = 1MHz (pF)
V07E130P	P7V130	V07E130	7V130	130	170	12.5	1750	1200	184	226	340	10	180
V10E130P	P10V130	V10E130	10V130	130	170	25	3500	2500	184	226	340	25	450
V14E130P	P14V130	V14E130	14V130	130	170	50	6000	4500	184	226	340	50	1000
V20E130P	P20V130	V20E130	20V130	130	170	100	10000	6500	184	226	340	100	1900
V07E140P	P7V140	V07E140	7V140	140	180	13.5	1750	1200	200	240	360	10	160
V10E140P	P10V140	V10E140	10V140	140	180	27.5	3500	2500	200	240	360	25	400
V14E140P	P14V140	V14E140	14V140	140	180	55	6000	4500	200	240	360	50	900
V20E140P	P20V140	V20E140	20V140	140	180	110	10000	6500	200	240	360	100	1750
V07E150P	P7V150	V07E150	7V150	150	200	15	1750	1200	216	264	395	10	150
V10E150P	P10V150	V10E150	10V150	150	200	30	3500	2500	216	264	395	25	360
V14E150P	P14V150	V14E150	14V150	150	200	60	6000	4500	216	264	395	50	800
V20E150P	P20V150	V20E150	20V150	150	200	120	10000	6500	216	264	395	100	1600
V07E175P	P7V175	V07E175	7V175	175	225	17	1750	1200	243	297	455	10	130
V10E175P	P10V175	V10E175	10V175	175	225	35	3500	2500	243	297	455	25	350
V14E175P	P14V175	V14E175	14V175	175	225	70	6000	4500	243	297	455	50	700
V20E175P	P20V175	V20E175	20V175	175	225	135	10000	6500	243	297	455	100	1400
V07E230P	P7V230	V07E230	7V230	230	300	20	1750	1200	324	396	595	10	100
V10E230P	P10V230	V10E230	10V230	230	300	42	3500	2500	324	396	595	25	250
V14E230P	P14V230	V14E230	14V230	230	300	80	6000	4500	324	396	595	50	550
V20E230P	P20V230	V20E230	20V230	230	300	160	10000	6500	324	396	595	100	1100
V07E250P	P7V250	V07E250	7V250	250	320	25	1750	1200	351	429	650	10	90
V10E250P	P10V250	V10E250	10V250	250	320	50	3500	2500	351	429	650	25	220
V14E250P	P14V250	V14E250	14V250	250	320	100	6000	4500	351	429	650	50	500
V20E250P	P20V250	V20E250	20V250	250	320	170	10000	6500	351	429	650	100	1000
V07E275P	P7V275	V07E275	7V275	275	350	28	1750	1200	387	473	710	10	80
V10E275P	P10V275	V10E275	10V275	275	350	55	3500	2500	387	473	710	25	200
V14E275P	P14V275	V14E275	14V275	275	350	110	6000	4500	387	473	710	50	450
V20E275P	P20V275	V20E275	20V275	275	350	190	10000	6500	387	473	710	100	900
V07E300P	P7V300	V07E300	7V300	300	385	30	1750	1200	423	517	775	10	70
V10E300P	P10V300	V10E300	10V300	300	385	60	3500	2500	423	517	775	25	180
V14E300P	P14V300	V14E300	14V300	300	385	125	6000	4500	423	517	775	50	400
V20E300P	P20V300	V20E300	20V300	300	385	250	10000	6500	423	517	775	100	800
V07E320P	P7V320	V07E320	7V320	320	420	32	1750	1200	459	561	840	10	65
V10E320P	P10V320	V10E320	10V320	320	420	67	3500	2500	459	561	840	25	170
V14E320P	P14V320	V14E320	14V320	320	420	136	6000	4500	459	561	840	50	380
V20E320P	P20V320	V20E320	20V320	320	420	273	10000	6500	459	561	840	100	750
V07E385P	P7V385	V07E385	7V385	385	505	36	1750	1200	558	682	1025	10	60
V10E385P	P10V385	V10E385	10V385	385	505	75	3500	2500	558	682	1025	25	160
V14E385P	P14V385	V14E385	14V385	385	505	150	6000	4500	558	682	1025	50	360
V20E385P	P20V385	V20E385	20V385	385	505	300	10000	6500	558	682	1025	100	700
V07E420P	P7V420	V07E420	7V420	420	560	40	1750	1200	612	748	1120	10	55
V10E420P	P10V420	V10E420	10V420	420	560	80	3500	2500	612	748	1120	25	140
V14E420P	P14V420	V14E420	14V420	420	560	160	6000	4500	612	748	1120	50	300
V20E420P	P20V420	V20E420	20V420	420	560	320	10000	6500	612	748	1120	100	600
V07E440P	P7V440	V07E440	7V440	440	585	44	1750	1200	643	787	1180	10	50
V10E440P	P10V440	V10E440	10V440	440	585	85	3500	2500	643	787	1180	25	130
V14E440P	P14V440	V14E440	14V440	440	585	170	6000	4500	643	787	1180	50	260
V20E440P	P20V440	V20E440	20V440	440	585	340	10000	6500	643	787	1180	100	500
V07E460P	P7V460	V07E460	7V460	460	615	48	1750	1200	675	825	1240	10	45

UltraMOV™ Series Ratings & Specifications (Continued...)

Lead-free and RoHS Compliant Models		Standard Models		Maximum Rating (85°C)					Specifications (25°C)				
				Continuous		Transient			Varistor Voltage at 1mA DC Test Current		Maximum Clamping Voltage 8 x 20µs		Typical Capacitance
				RMS Volts	DC Volts	Energy 2ms	Peak Current 8 x 20µs						
Part Number	Branding	Part Number	Branding	V _{M(AC)} (V)	V _{M(DC)} (V)	W _{TM} (J)	I _{TM} 1 x Pulse (A)	I _{TM} 2 x Pulse (A)	V _{NOM} Min (V)	V _{NOM} Max (V)	V _C (V)	I _{PK} (A)	f = 1MHz (pF)
V10E460P	P10V460	V10E460	10V460	460	615	90	3500	2500	675	825	1240	25	120
V14E460P	P14V460	V14E460	14V460	460	615	180	6000	4500	675	825	1240	50	220
V20E460P	P20V460	V20E460	20V460	460	615	360	10000	6500	675	825	1240	100	400
V10E510P	P10V510	V10E510	10V510	510	670	80	3500	2500	738	902	1355	25	110
V14E510P	P14V510	V14E510	14V510	510	670	165	6000	4500	738	902	1355	50	200
V20E510P	P20V510	V20E510	20V510	510	670	325	10000	6500	738	902	1355	100	350
V10E550P	P10V550	V10E550	10V550	550	745	90	3500	2500	819	1001	1500	25	100
V14E550P	P14V550	V14E550	14V550	550	745	180	6000	4500	819	1001	1500	50	180
V20E550P	P20V550	V20E550	20V550	550	745	360	10000	6500	819	1001	1500	100	300
V10E625P	P10V625	V10E625	10V625	625	825	100	3500	2500	900	1100	1650	25	90
V14E625P	P14V625	V14E625	14V625	625	825	200	6000	4500	900	1100	1650	50	160
V20E625P	P20V625	V20E625	20V625	625	825	400	10000	6500	900	1100	1650	100	250

NOTE:

1. Average power dissipation of transients should not exceed 0.25W, 0.4W, 0.6W and 1.0W for 7mm, 10mm, 14mm, and 20mm model sizes, respectively.

Power Dissipation Ratings

Should transients occur in rapid succession, the average power dissipation is the energy (watt-seconds) per pulse times the number of pulses per second. The power so developed must be within the specifications shown on the Device Ratings and Specifications Table for the specific device. Furthermore, the operating values need to be derated at high temperatures as shown in above. Because varistors can only dissipate a relatively small amount of average power they are, therefore, not suitable for repetitive applications that involve substantial amounts of average power dissipation.

Current Energy and Power Derating Curve

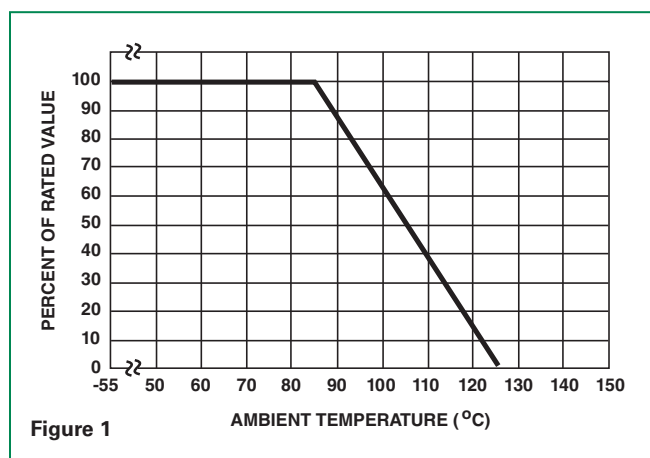

Peak Pulse Current Test Waveform

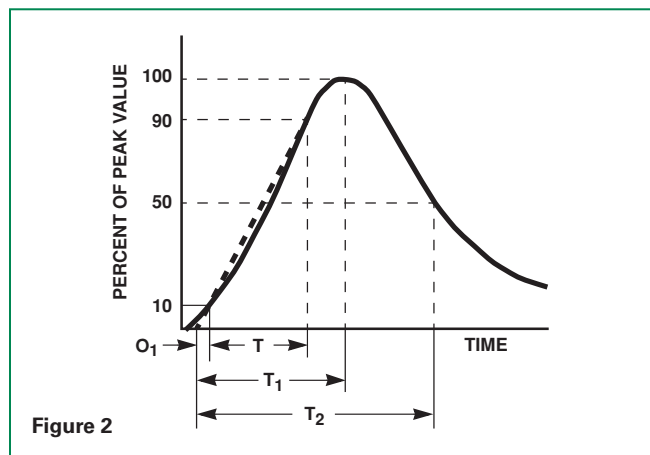

O₁ = Virtual Origin of Wave
 T = Time from 10% to 90% of Peak
 T₁ = Rise Time = 1.25 x T
 T₂ = Decay Time

Example - For an 8/20 µs Current Waveform:

8µs = T₁ = Rise Time
 20µs = T₂ = Decay Time

Transient V-I Characteristics Curves

Maximum Clamping Voltage for 7mm Parts

V7E130(P)-V7E460(P)

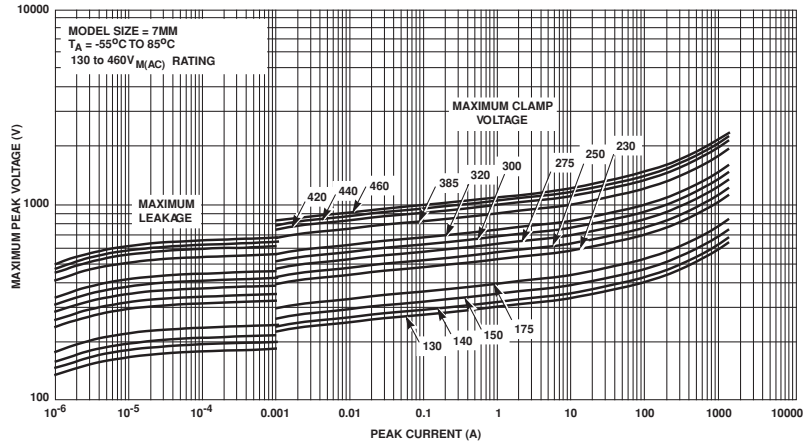

Figure 3

Maximum Clamping Voltage for 10mm Parts

V10E130(P)-V10E625(P)

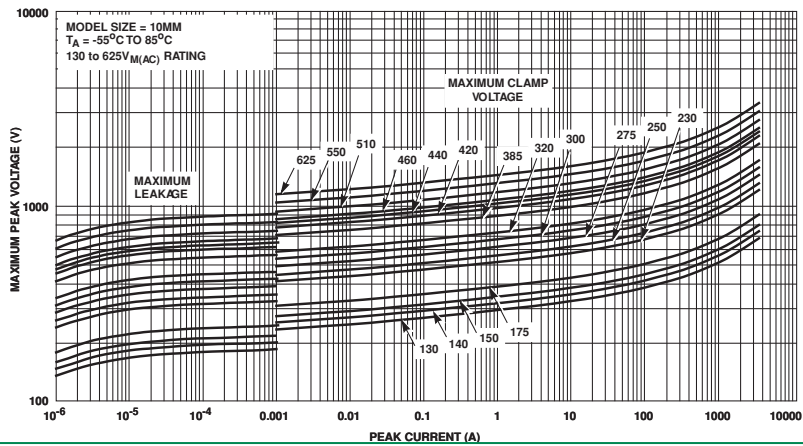

Figure 4

Maximum Clamping Voltage for 14mm Parts

V14E130(P) - V14E625(P)

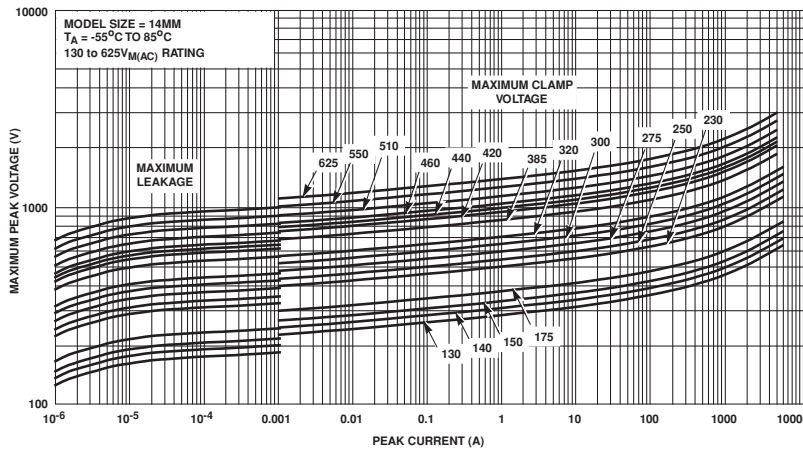
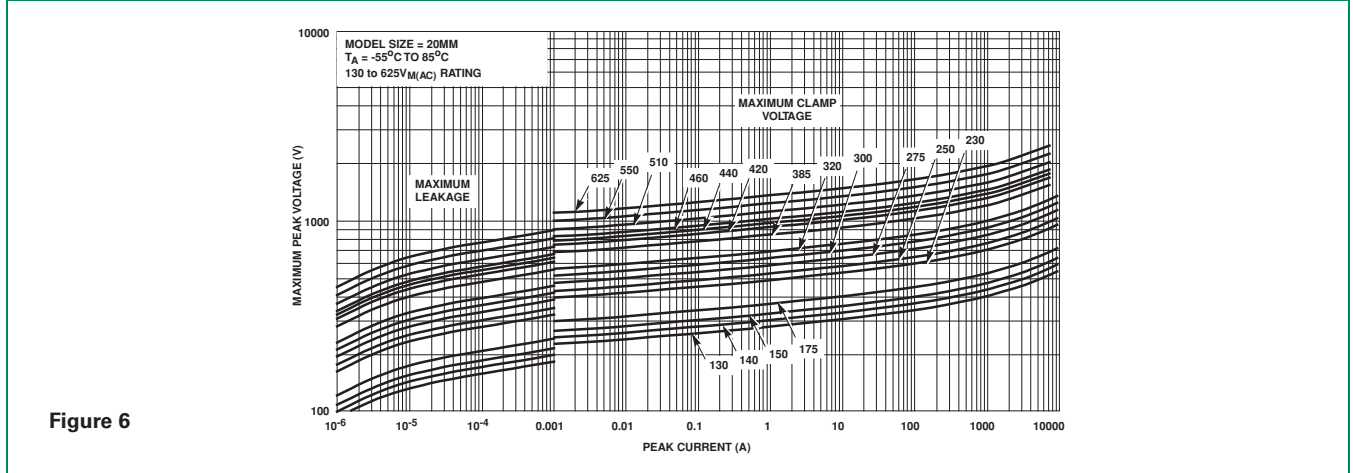

Figure 5

Transient V-I Characteristics Curves (Continued...)

Maximum Clamping Voltage for 20mm Parts

V20E130(P) - V20E625(P)



Pulse Rating Curves

Repetitive Surge Capability for 7mm Parts

V7E130(P) - V7E460(P)

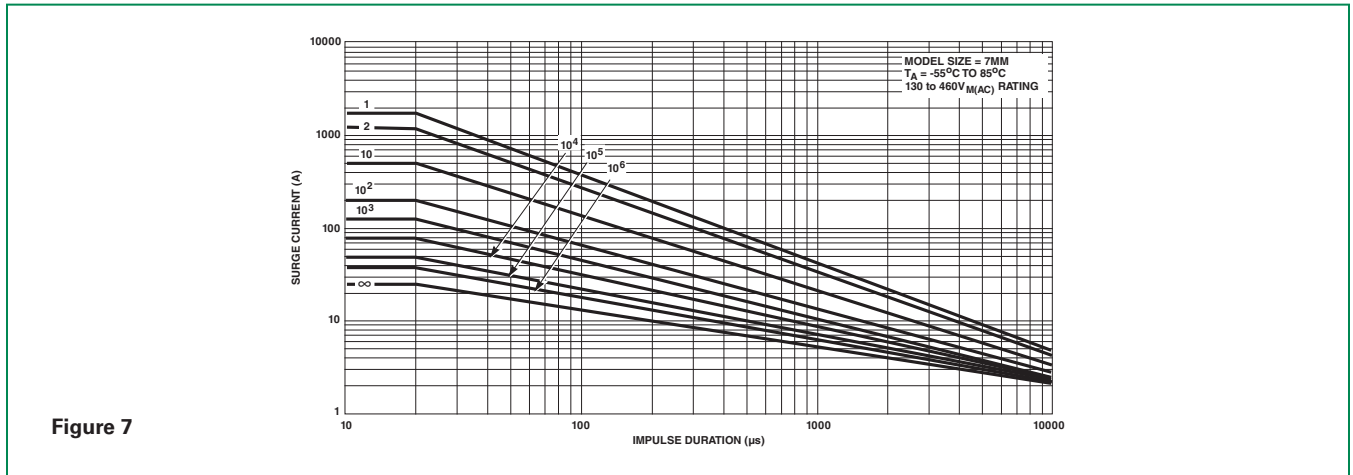

Pulse Rating Curves (Continued...)

Repetitive Surge Capability for 10mm Parts

V10E130(P) - V10E625(P)

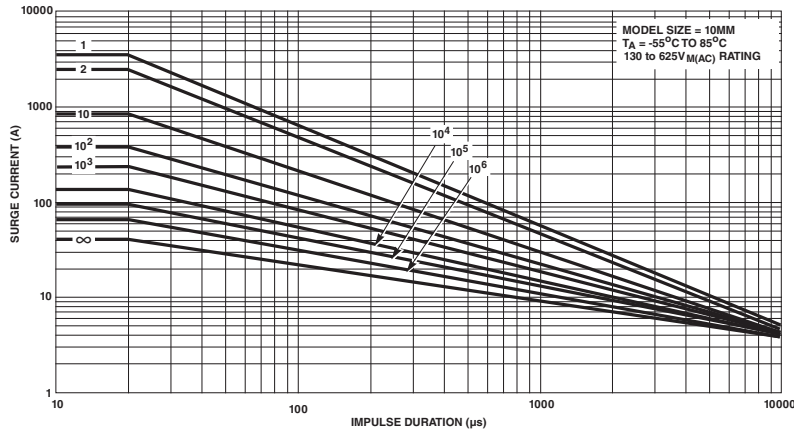

Figure 8

Repetitive Surge Capability for 14mm Parts

V14E130(P) - V14E625(P)

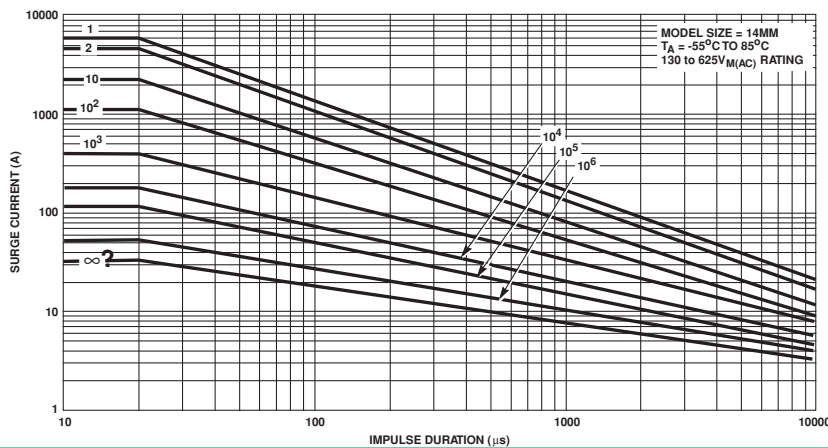

Figure 9

Repetitive Surge Capability for 20mm Parts

V20E130(P) - V20E625(P)

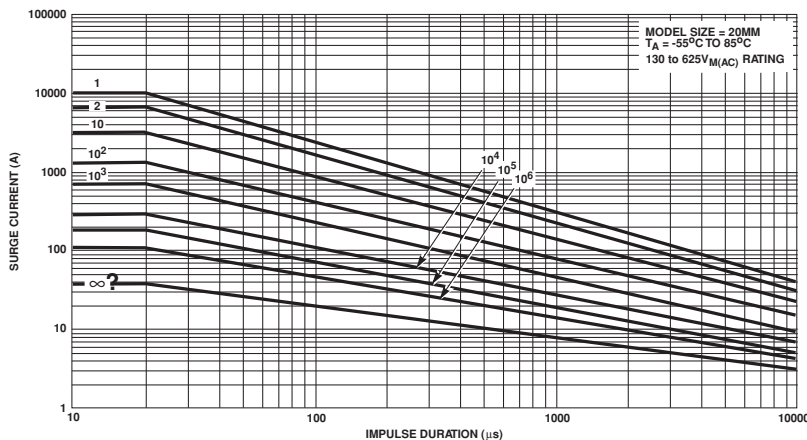

Figure 10

Wave Solder Profile

Non Lead-free Profile

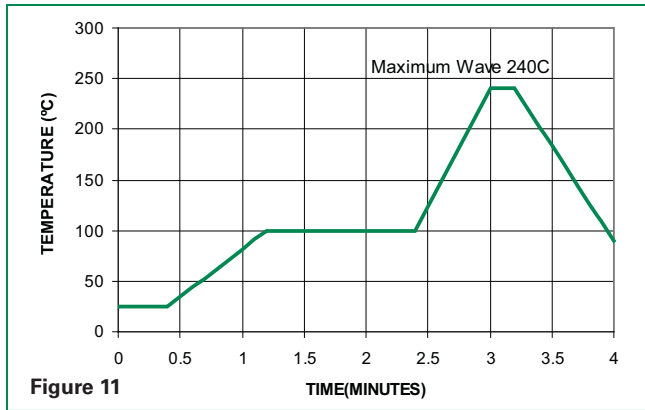

Figure 11

Lead-free Profile

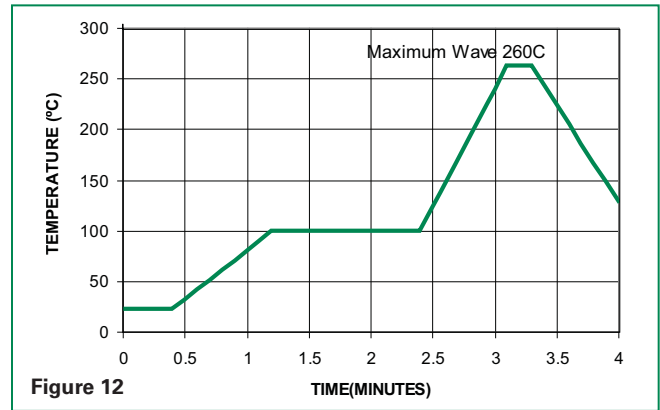

Figure 12

Physical Specifications

Lead Material	Tin-C coated Copper Wire
Soldering Characteristics	Solderability per MIL-STD-202, Method 208E
Insulating Material	Cured, flame retardant epoxy polymer meets UL94V-0 requirements
Device Labeling	Marked with LF, voltage, UL/CSA logos, and date code

Environmental Specifications

Operating/Storage Temperature	-55°C to +85°C/-55°C to +125°C
Humidity Aging	+85°C, 85% RH, 1000 hours +/-10% typical voltage change
Thermal Shock	+85°C to -40°C 5 times +/-10% typical voltage change
Solvent Resistance	MIL-STD-202, Method 215F
Moisture Sensitivity	Level 1, J-STD-020C

ULTRAMOV™ Series

UltraMOV™ Series Varistors for Hi-Temperature Operating Conditions:

- Phenolic Coated UltraMOV™ Series devices are available with improved maximum operating temperature 125°C.
- These devices also have improved temperature cycling performance capability.
- Ratings and Specifications are as per standard UltraMOV™ Series except Hi-Pot Encapsulation (Isolation Voltage Capability) = 500V.
- Phenolic Coating is HALOGEN FREE. To order: change 'E' (Epoxy coating) in part number to 'P' (Phenolic coating; e.g. V20P230). See Part Numbering System section of this series for more information.
- UL Approval for Phenolic Coating parts to E75961 Pending.
- Contact factory for further details.

Product Dimensions (mm)

Lead form options L1 and L3 (refer to table below)

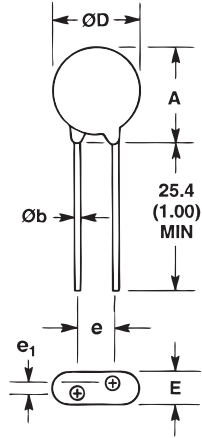

Lead form options L2 and L4 (refer to table below)

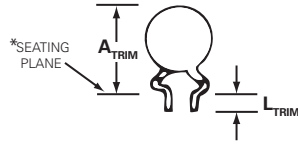

*Seating plane interpretation per IEC-717
(not available on tape or ammo pack)

Dimension	V _{RMS} Voltage Model	7mm Size		10mm Size		14mm Size		20mm Size	
		Min. mm (in)	Max. mm (in)	Min. mm (in)	Max. mm (in)	Min. mm (in)	Max. mm (in)	Min. mm (in)	Max. mm (in)
A	130-320	-	12 (0.472)	-	16 (0.630)	-	20 (0.787)	-	26.5 (1.043)
	385-625	-	13 (0.512)	-	17 (0.689)	-	20.5 (0.807)	-	28 (1.102)
ØD	All	-	9 (0.354)	-	12.5 (0.492)	-	17 (0.669)	-	23 (0.906)
e (Note 2)	All	4 (0.157)	6 (0.236)	6.5 (0.256)	8.5 (0.335)	6.5 (0.256)	8.5 (0.335)	9 (0.354)	11 (0.433)
e ₁ (Note 3)	130-320	1.5 (0.059)	3.5 (0.138)	1.5 (0.059)	3.5 (0.138)	1.5 (0.059)	3.5 (0.138)	1.5 (0.059)	3.5 (0.138)
	385-625	2.5 (0.098)	5.5 (0.217)	2.5 (0.098)	5.5 (0.217)	2.5 (0.098)	5.5 (0.217)	2.5 (0.098)	5.5 (0.217)
E	130-320	-	5.6 (0.220)	-	5.6 (0.220)	-	5.6 (0.220)	-	5.6 (0.220)
	385-510	-	7.3 (0.287)	-	7.3 (0.287)	-	7.3 (0.287)	-	7.3 (0.287)
	550-625	-	8.3 (0.327)	-	8.3 (0.327)	-	8.3 (0.327)	-	8.3 (0.327)
Ø b	All	0.585 (0.023)	0.685 (0.027)	0.76 (0.030)	0.86 (0.034)	0.76 (0.030)	0.86 (0.034)	0.76 (0.030) (Note 2)	0.86 (0.034) (Note 2)
A _{TRIM}	All	-	15 (0.591)	-	19.5 (0.768)	-	22.5 (0.886)	-	29.0 (1.142)
L (L2)	All	25.4 (1.00)	-	25.4 (1.00)	-	25.4 (1.00)	-	25.4 (1.00)	-
*L (L4)	All	2.41 (0.095)	4.69 (0.185)	2.41 (0.095)	4.69 (0.185)	2.41 (0.095)	4.69 (0.185)	2.41 (0.095)	4.69 (0.185)

NOTES:

1. Measurements displayed in Millimeters (Inches in parentheses).
2. Standard lead space.
3. For in-line lead option L3, dimension e, is "zero". Straight lead form option L1 shown.

For information about bulk packaging quantities, please refer to the Ordering Notes section at the end of this document.

Tape Specifications for Reel and Ammo Pack Items (Refer to dimensions on following page)

7mm Devices

10, 14 and 20mm Devices

CRIMPED LEADS "L2"

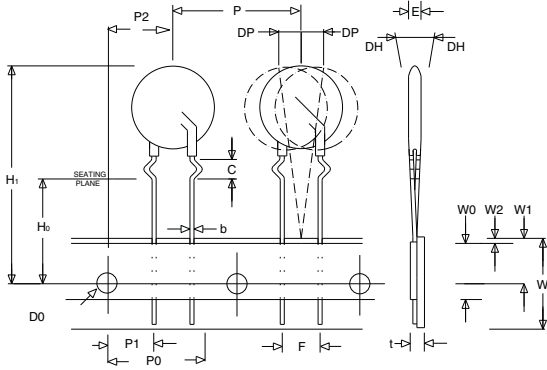

CRIMPED LEADS "L2"

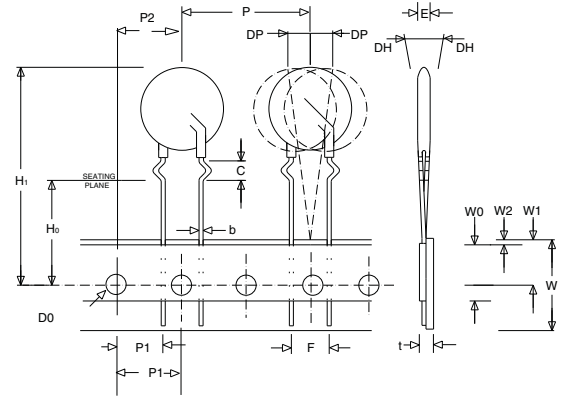

INLINE LEADS "L3"

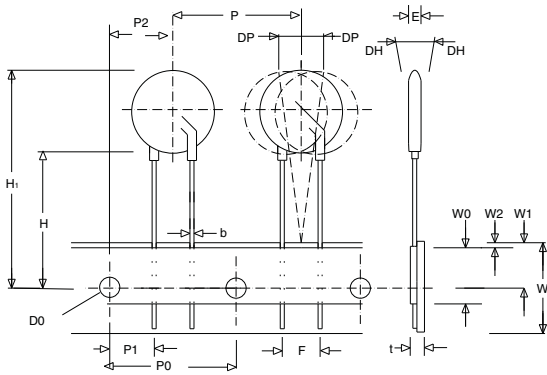

INLINE LEADS "L3"

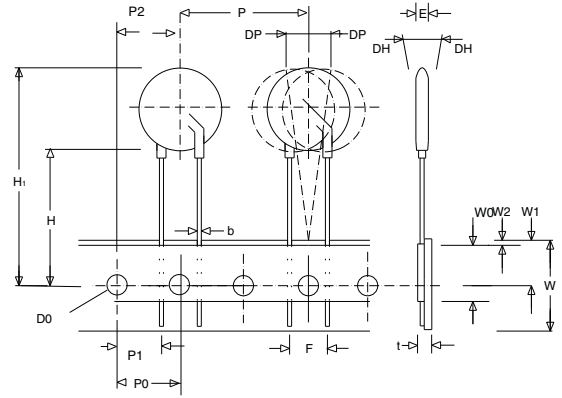

STRAIGHT LEADS "L1"

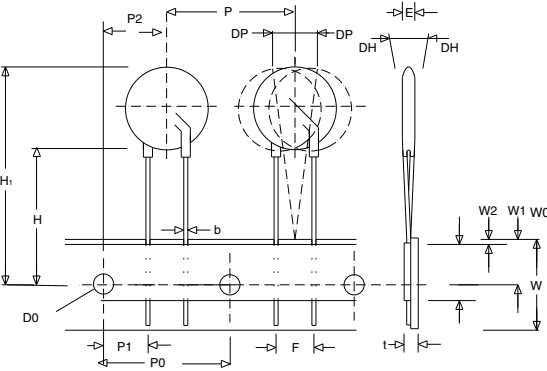

STRAIGHT LEADS "L1"

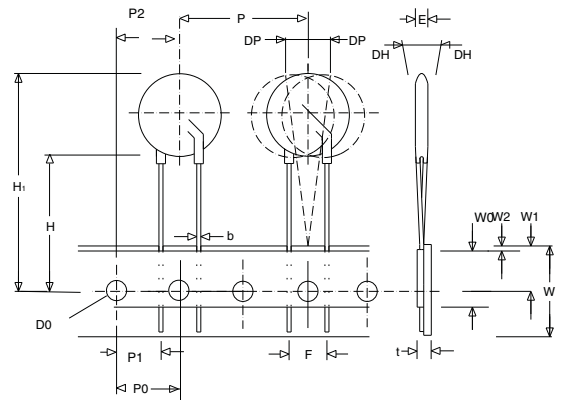

ULTRAMOV™ Series

Tape Specifications for Reel and Ammo Pack Items (Refer to drawings on previous page)

- Conforms to ANSI and EIA specifications.
- Can be supplied to IEC Publication 286-2.
- Radial devices on tape are offered with crimped leads, straight leads, or in-line leads. See Ordering Information.
- For 10mm devices 'P' (component pitch) is 12.7mm when 'F' (lead space) is 5mm.
- 7mm parts are available on tape and reel up to 460 VAC only
- 10mm parts are available on tape and reel up to 510 VAC only
- 14mm and 20mm parts are available on tape and reel up to 550 VAC only
- 7mm devices with 7.5mm lead spacing option will be taped at 25.4mm component pitch and 500 pieces per reel
- 10mm devices with 5.0mm lead spacing option will be taped at 12.7mm component pitch and 1000 pieces per reel

Symbol	Description	Model Size			
		7mm	10mm	14mm	20mm
B₁	Component Top to Seating Plane	15 Max	19.5 Max	22.5 Max	29 Max
C	Crimp Length	2.4 Typ	2.6 Typ	2.6 Typ	2.6 Typ
P	Pitch of Component	12.7 +/- 1.0	25.4 +/- 1.0	25.4 +/- 1.0	25.4 +/- 1.0
P₀	Feed Hole Pitch	12.7 +/- 0.2	12.7 +/- 0.2	12.7 +/- 0.2	12.7 +/- 0.2
P₁	Feed Hole Center to Pitch	3.85 +/- 0.7	8.85 +/- 0.7	8.85 +/- 0.7	7.70 +/- 0.7
P₂	Hole Center to Component Center	6.35 +/- 0.7	12.7 +/- 0.7	12.7 +/- 0.7	12.7 +/- 0.7
F	Lead to Lead Distance	5.0 +/- 0.8	7.5 +/- 0.8	7.5 +/- 0.8	10.0 +/- 0.8
Δh	Component Alignment	2.0 Max	2.0 Max	2.0 Max	2.0 Max
W	Tape Width	18.0 +1.0 / -0.5	18.0 +1.0 / -0.52	18.0 +1.0 / -0.5	18.0 +1.0 / -0.5
W₀	Hold Down Tape Width	12.0 +/- 0.3	12.0 +/- 0.3	12.0 +/- 0.3	12.0 +/- 0.3
W₁	Hole Position	9.0 +0.75 / -0.50	9.0 +0.75 / - 0.50	9.0 +0.75 / 0.50	9.0 +0.75 / -0.50
W₂	Hold Down Tape Position	0.5 Max	0.5 Max	0.5 Max	0.5 Max
H	Height from Tape Center to Component Base	18.0 +2.0 / -0.0	18.0 +2.0 / -0.0	18.0 +2.0 / -0.0	18.0 +2.0 / -0.0
H₀	Seating Plane Height	16.0 +/- 0.5	16.0 +/- 0.5	16.0 +/- 0.5	16.0 +/- 0.5
H₁	Component Height	32.0 Max	36.0 Max	40.0 Max	46.5 Max
D₀	Feed Hole Diameter	4.0 +/- 0.2	4.0 +/- 0.2	4.0 +/- 0.2	4.0 +/- 0.2
t	Total Tape Thickness	0.7 +/- 0.2	0.7 +/- 0.2	0.7 +/- 0.2	0.7 +/- 0.2
Δp	Component Alignment	3° Max, 1.00mm	3° Max, 1.00mm	3° Max, 1.00mm	3° Max, 1.00mm

For information on tape and reel packaging quantities, please refer to the Ordering Notes section at the end of this document.

Part Numbering System

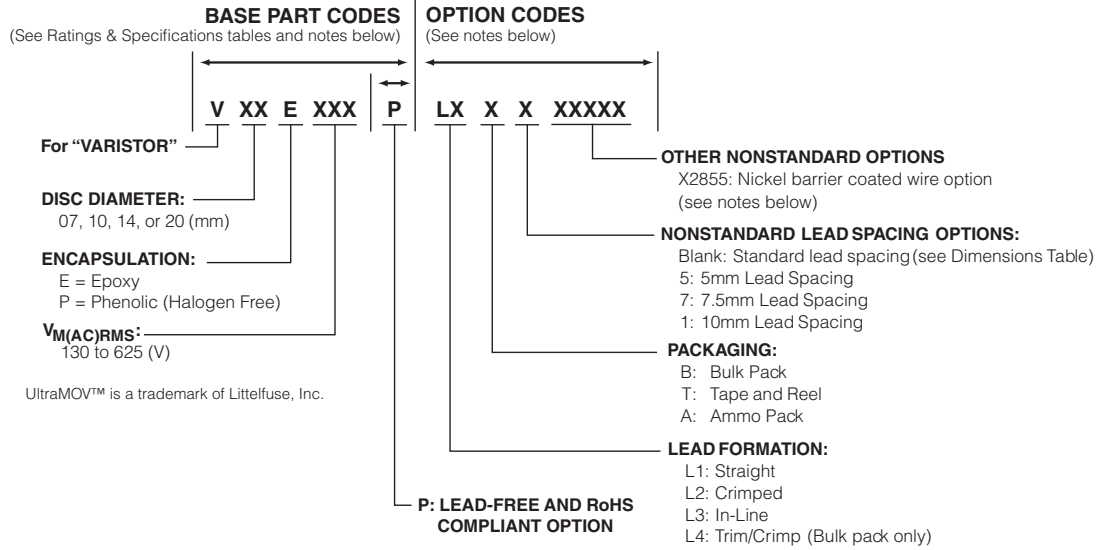

Ordering Notes:

For standard parts, use the **BASE PART** designator only.

For parts with non-standard options (such as additional form, packaging and lead space options) use, **BASE PART + OPTION CODE**.

OPTION CODE items are subject to availability and minimum order requirements. Please contact a Littelfuse representative if you require additional information

BASE PART CODES:

Lead-free/RoHS Designator:

For Lead-free and RoHS compliant parts add "P" after the **BASE PART** number and before any other **OPTION CODE**:

Standard Model	Order As
V07E130	V07E130 P

Standard Model with Option	Order As
V07E130L1B5	V07E130 PL 1B5

OPTION CODES:

X2855: Nickel Barrier COATED WIRE OPTION

All standard parts use Tin-coated Copper Wire Nickel Barrier Coated Wire is available as an option, consisting of Copper Wire with a flashing of Nickel followed by a top coating of Tin.

To order: append standard model **BASE PART** number with "X2855." Example:

Standard Model	Order As
V18ZA40	V18ZA40 X2855

PACKAGING:

Littelfuse UltraMOV™ varistors are shipped standard in bulk pack with straight leads and lead spacing outlined in the dimensions sections of this document. Contact a Littelfuse representative to discuss non-standard options.

Standard Part Default Conditions

Device Size	Part #	Lead Space	Packaging
7mm	V07E-	5.0-/±1	Bulk
10mm	V10E-	7.5-/±1	Bulk
14mm	V14E-	7.5-/±1	Bulk
20mm	V20E-	10.0-/±1	Bulk

Standard Bulk Pack Quantity

Varistor Voltage	Standard Bulk Pack Quantity			
	Varistor Model Size			
	7mm	10mm	14mm	20mm
130 – 275	1500	1000	700	500
300 – 460	1500	700	600	400
510 – 625	1500	700	500	400

Tape & Reel Quantity

Varistor Voltage	Shipping Quantity Per Reel			
	7mm	10mm	14mm	20mm
130 – 275	1000	500	500	500
300 – 625	1000	500	400	400