

Three-phase Voltage Relay K8AB-PW

Ideal for monitoring 3-phase power supplies for industrial facilities and equipment.

- Monitor overvoltages and undervoltages for three-phase 3-wire or 4-wire power supplies.
Switch setting for 3-phase 3-wire or 3-phase 4-wire power supply.
- Two SPDT output relays, 6 A at 250 VAC (resistive load).
Separate outputs possible for overvoltages and undervoltages.
- World-wide power specifications supported by one Unit (switchable).
- Relay warning status easily monitoring using LED indicator.
- Easy wiring with ferrules
2 × 2.5 mm² solid or 2 × 1.5 mm² standard ferrules.
- CE mark compliance certified by third party.
UL certification pending.

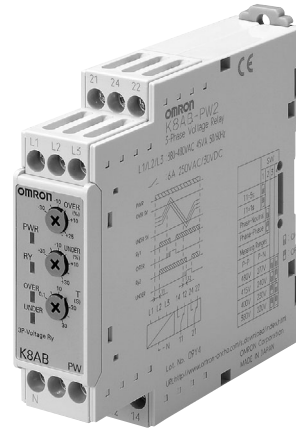

Model Number Structure

■ Model Number Legend

K8AB-□□
1 2 3

- 1. Basic Model**
K8AB: Measuring and Monitoring Relays
- 2. Functions**
PW: Three-phase Voltage Relay (Simultaneous upper and lower monitoring)
- 3. Rated Input Voltage**
 - 1: 115, 127, 133, 138, 200, 220, 230, 240 VAC
 - 2: 220, 230, 240, 277, 380, 400, 415, 480 VAC

Ordering Information

■ List of Models

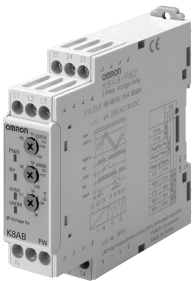
Three-phase Voltage Relay	Rated input (See note 2.)		Model
	3-phase 3-wire mode	200, 220, 230, 240 VAC	K8AB-PW1
	3-phase 4-wire mode	115, 127, 133, 138 VAC	
	3-phase 3-wire mode	380, 400, 415, 480 VAC	K8AB-PW2
	3-phase 4-wire mode	220, 230, 240, 277 VAC	

- Note:** 1. Three-phase 3-wire or 4-wire and the input range are switched using a switch.
 2. The power supply is shared with the rated input voltage.

Ratings and Specifications

■ Ratings

Rated input voltage	K8AB-PW1	Three-phase, three-wire mode: 200, 220, 230, 240 VAC Three-phase, four-wire mode: 115, 127, 133, 138 VAC
	K8AB-PW2	Three-phase, three-wire mode: 380, 400, 415, 480 VAC Three-phase, four-wire mode: 220, 230, 240, 277 VAC
Operation (overvoltage and undervoltage)	Operating value setting range	Overvoltage = -30% to 25% of maximum rated input voltage Undervoltage = -30% to 25% of maximum rated input voltage Note: The rated input voltage is switched with a switch.
	Operating value	100% operation at set value
Reset (HYS.)	Hysteresis	5% of operating value (fixed)
	Resetting method	Automatic reset
Operating time (T)	Overvoltage/undervoltage	0.1 to 30 s (Value when input rapidly changes from 0% to 120%.)
Power ON lock (LOCK)		1 s or 5 s (Value when input rapidly changes from 0% to 100%. The operating time is the shortest at this point.)
Setting accuracy		±10% of full scale
Time error		±10% of set value (Minimum error: 50 ms)
Input frequency		45 to 65 Hz
Input impedance		100 kΩ min.
Indicators		Power (PWR): Green LED, Relay output (RY): Yellow LED, Alarm outputs (ALM1/2): Red LED
Output relays		Two SPDT relays (6 A at 250 VAC, resistive load) Normally closed operation (normally ON) (separate outputs possible for overvoltages and undervoltages)

■ Specifications

Ambient operating temperature		-20 to 60°C (with no condensation or icing)
Storage temperature		-40 to 70°C (with no condensation or icing)
Ambient operating humidity		25% to 85%
Storage humidity		25% to 85%
Altitude		2,000 m max.
Voltage fluctuation range		85% to 110% of rated input voltage
Input frequency		50/60 Hz ±5 Hz (AC power supply)
Output relays	Resistive load	6 A at 250 VAC (cos φ = 1) 6 A at 30 VDC (L/R = 0 ms)
	Inductive load	1 A at 250 VAC (cos φ = 0.4) 1 A at 30 VDC (L/R = 7 ms)
	Minimum load	10 mA at 5 VDC
	Maximum contact voltage	250 VAC
	Maximum contact current	6 A AC
	Maximum switching capacity	1,500 VA
	Mechanical life	10,000,000 operations
	Electrical life	Make: 50,000 times, Break: 30,000 times
Terminal screw tightening torque		1.2 N·m
Crimp terminals		Two solid wires of 2.5 mm ² , two crimp terminals of 1.5 mm ² with insulation sleeves, can be tightened together
Insulation resistance		20 MΩ (at 500 V) between charged terminals and exposed uncharged parts 20 MΩ (at 500 V) between any charged terminals (i.e., between input, output, and power supply terminals)
Degree of protection		Terminal section: IP20, Rear case: IP40
Case color		Munsell 5Y8/1 (ivory)
Case material		ABS resin (self-extinguishing resin) UL94-V0
Weight		200 g
Mounting		Mounted to DIN Track or via M4 screws
Dimensions		22.5 (W) x 90 (H) x 100 (D) mm
Installation environment		Overvoltage Category III, Pollution Degree 2
Application standards		EN60255-5/-6
Safety standards		EN60664-1
EMC		EMI: EN61326 Industrial applications Electromagnetic interference wave CISPR11 Group 1, Class A: CISPR16-1/-2 Terminal interference wave voltage CISPR11 Group 1, Class A: CISPR16-1/-2 EMS: EN61326 Industrial applications Electrostatic discharge EN61000-4-2: 8 kV (in air) Radiating radio-frequency electromagnetic field EN61000-4-3: 10 V/m 1 kHz sine wave amplitude modulation (80 MHz to 1 GHz) Burst EN61000-4-4: 1 kV (I/O signal line), 2 kV (power line) Surge EN61000-4-5: 1 kV with line (power line), 2 kV with ground (power line) Conducted RF EN61000-4-6: 3 V (0.15 to 80 MHz) Power frequency magnetic field immunity EN61000-4-8: 30 A/m Voltage dip/short interruptions EN61000-4-11: 0.5 cycle, 0.180° each, polarity 100% (rated voltage)

Connections

Wiring Diagram

Overvoltage and Undervoltage Operation Diagram

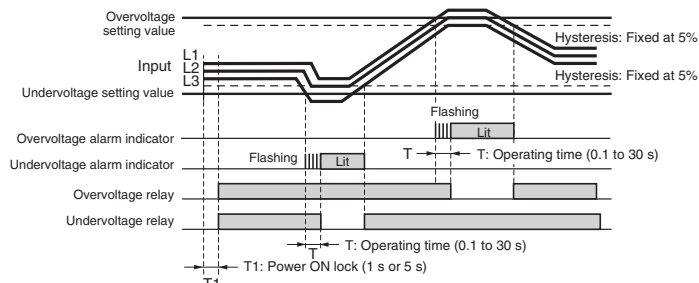

- Note:**
1. The K8AB-PW output relay is normally operative.
 2. The power ON lock prevents unnecessary alarms from being generated during the instable period when the power is first turned on. There is no relay output during timer operation.

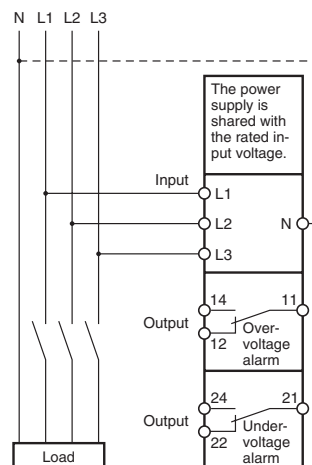

Nomenclature

Front

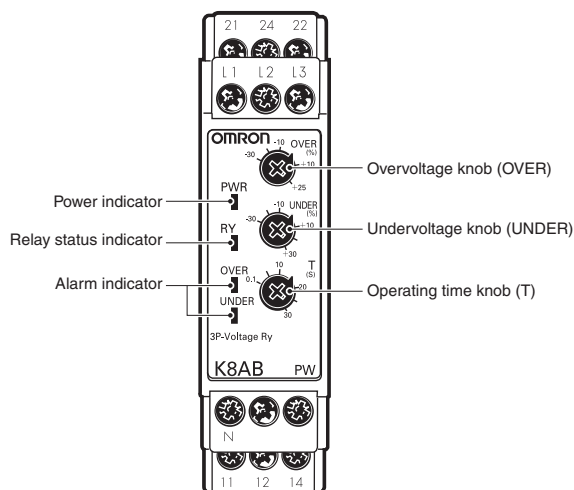

Indicators

Item	Meaning	
Power indicator (PWR: Green)	Lit when power is being supplied.	
Relay status indicator (RY: Yellow)	Lit when relay is operating (normally lit).	
Alarm indicator (ALM: Red)	Overvoltage: Red	The indicator flashes to indicate the error status after the overvoltage has exceeded the threshold value while the operating time is being clocked.
	Undervoltage: Red	The indicator flashes to indicate the error status after the undervoltage has exceeded the threshold value while the operating time is being clocked.

Setting Knobs

Item	Usage
Overvoltage knob (OVER)	Used to set the voltage to -30% to 25% of the rated input voltage.
Undervoltage knob (UNDER)	Used to set the voltage to -30% to 25% of the rated input voltage.
Operating time knob (T)	Used to set the operating time to 0.1 to 30 s.

■ Bottom

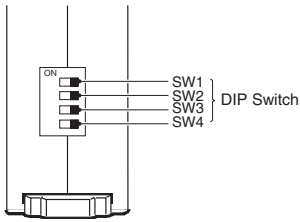

DIP Switch Functions

		Function		Default
SW1	Power ON lock time	OFF	1 s	OFF
		ON	5 s	
SW2	Monitoring mode selector	OFF	3-phase 3-wire power monitoring mode	OFF
		ON	3-phase 4-wire power monitoring mode	

SW3	SW4	Function	Function		Default	
			3-phase 3-wire mode	3-phase 4-wire mode	SW3	SW4
OFF	OFF	Rated input voltage switch (K8AB-PW1)	200 VAC	115 VAC	OFF	OFF
ON	OFF		220 VAC	127 VAC		
OFF	ON		230 VAC	133 VAC		
ON	ON		240 VAC	138 VAC		
OFF	OFF	Rated input voltage switch (K8AB-PW2)	380 VAC	220 VAC	OFF	OFF
ON	OFF		400 VAC	230 VAC		
OFF	ON		415 VAC	240 VAC		
ON	ON		480 VAC	277 VAC		

Dimensions

K8AB-PW

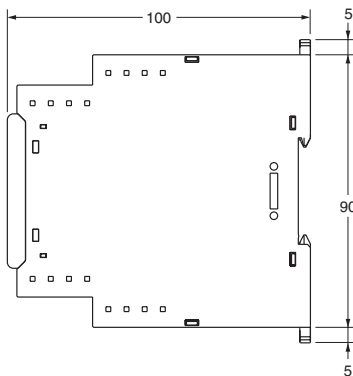
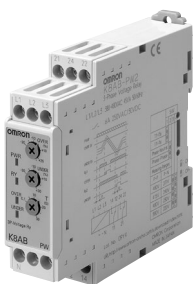

Safety Precautions

■ Precautions for Safe Use

Make sure to follow the instructions below to ensure safety.

1. Do not use or keep this product in the following environments.
 - Outdoors, or places subject to direct sunlight or wearing weather.
 - Places where dust, iron powder, or corrosive gases (in particular, sulfuric or ammonia gas) exist.
 - Places subject to static electricity or inductive noise.
 - Places where water or oil come in contact with the product.
2. Make sure to install this product in the correct direction.
3. There is a remote risk of electric shock. Do not touch terminals while electricity is being supplied.
4. Make sure to thoroughly understand all instructions in the Instructions Manual before handling this product.
5. Make sure to confirm terminal makings and polarity for correct wiring.
6. Tighten terminal screws firmly using the following torque.
Recommended torque: 0.54 N·m
7. Operating ambient temperature and humidity for this product must be within the indicated rating when using this product.
8. There is a remote risk of explosion. Do not use this product where flammable or explosive gas exists.
9. Make sure that no weight rests on the product after installation.
10. To enable an operator to turn off this product easily, install switches or circuit breakers that conform to relevant requirements of IEC60947-1 and IEC60947-3, and label them appropriately.

■ Precautions for Correct Use

For Proper Use

1. Do not use the product in the following locations.
 - Places subject to radiant heat from heat generating devices.
 - Places subject to vibrations or physical shocks.
2. Make sure to use setting values appropriate for the controlled object. Failure to do so can cause unintended operation, and may result in accident or corruption of the product.
3. Do not use thinner or similar solvent for cleaning. Use commercial alcohol.
4. When discarding, properly dispose of the product as industrial waste.
5. Only use this product within a board whose structure allows no possibility for fire to escape.

About Installation

1. When wiring, use only recommended crimp terminals.
2. Do not block areas around the product for proper dissipation of heat. (If you do not secure space for heat dissipation, life cycle of the product will be compromised.)
3. To avoid electrical shocks, make sure that power is not supplied to the product while wiring.
4. To avoid electrical shocks, make sure that power is not supplied to the product when performing DIP switch settings.

Noise Countermeasures

1. Do not install the product near devices generating strong high frequency waves or surges.
2. When using a noise filter, check the voltage and current and install it as close to the product as possible.
3. In order to prevent inductive noise, wire the lines connected to the product separately from power lines carrying high voltages or currents. Do not wire in parallel with or on the same cable as power lines.
Other measures for reducing noise include running lines along separate ducts and using shield lines.

To avoid faulty operations, malfunctions, or failure, observe the following operating instructions.

1. When turning on the power, make sure to realize rated voltage within 1 second from the time of first supply of electricity.
2. Make sure to use power supply for operations, inputs, and transformer with the appropriate capacity and rated burden.
3. Maintenance and handling of this product may only be performed by qualified personnel.
4. Distortion ratio of input wave forms must be 30% or less. Use of this product with circuits that have large distortion in wave forms may result in unwanted operations.
5. Using this product for thyristor controls or inverters will result in errors.
6. When setting the volume, adjust the control from the minimum side to the maximum side.

Warranty and Application Considerations

Read and Understand this Catalog

Please read and understand this catalog before purchasing the products. Please consult your OMRON representative if you have any questions or comments.

Warranty and Limitations of Liability

WARRANTY

OMRON's exclusive warranty is that the products are free from defects in materials and workmanship for a period of one year (or other period if specified) from date of sale by OMRON.

OMRON MAKES NO WARRANTY OR REPRESENTATION, EXPRESS OR IMPLIED, REGARDING NON-INFRINGEMENT, MERCHANTABILITY, OR FITNESS FOR PARTICULAR PURPOSE OF THE PRODUCTS. ANY BUYER OR USER ACKNOWLEDGES THAT THE BUYER OR USER ALONE HAS DETERMINED THAT THE PRODUCTS WILL SUITABLY MEET THE REQUIREMENTS OF THEIR INTENDED USE. OMRON DISCLAIMS ALL OTHER WARRANTIES, EXPRESS OR IMPLIED.

LIMITATIONS OF LIABILITY

OMRON SHALL NOT BE RESPONSIBLE FOR SPECIAL, INDIRECT, OR CONSEQUENTIAL DAMAGES, LOSS OF PROFITS, OR COMMERCIAL LOSS IN ANY WAY CONNECTED WITH THE PRODUCTS, WHETHER SUCH CLAIM IS BASED ON CONTRACT, WARRANTY, NEGLIGENCE, OR STRICT LIABILITY.

In no event shall the responsibility of OMRON for any act exceed the individual price of the product on which liability is asserted.

IN NO EVENT SHALL OMRON BE RESPONSIBLE FOR WARRANTY, REPAIR, OR OTHER CLAIMS REGARDING THE PRODUCTS UNLESS OMRON'S ANALYSIS CONFIRMS THAT THE PRODUCTS WERE PROPERLY HANDLED, STORED, INSTALLED, AND MAINTAINED AND NOT SUBJECT TO CONTAMINATION, ABUSE, MISUSE, OR INAPPROPRIATE MODIFICATION OR REPAIR.

Application Considerations

SUITABILITY FOR USE

OMRON shall not be responsible for conformity with any standards, codes, or regulations that apply to the combination of products in the customer's application or use of the products.

Take all necessary steps to determine the suitability of the product for the systems, machines, and equipment with which it will be used.

Know and observe all prohibitions of use applicable to this product.

NEVER USE THE PRODUCTS FOR AN APPLICATION INVOLVING SERIOUS RISK TO LIFE OR PROPERTY WITHOUT ENSURING THAT THE SYSTEM AS A WHOLE HAS BEEN DESIGNED TO ADDRESS THE RISKS, AND THAT THE OMRON PRODUCTS ARE PROPERLY RATED AND INSTALLED FOR THE INTENDED USE WITHIN THE OVERALL EQUIPMENT OR SYSTEM.

Disclaimers

PERFORMANCE DATA

Performance data given in this catalog is provided as a guide for the user in determining suitability and does not constitute a warranty. It may represent the result of OMRON's test conditions, and the users must correlate it to actual application requirements. Actual performance is subject to the OMRON *Warranty and Limitations of Liability*.

CHANGE IN SPECIFICATIONS

Product specifications and accessories may be changed at any time based on improvements and other reasons. Consult with your OMRON representative at any time to confirm actual specifications of purchased product.

DIMENSIONS AND WEIGHTS

Dimensions and weights are nominal and are not to be used for manufacturing purposes, even when tolerances are shown.

ALL DIMENSIONS SHOWN ARE IN MILLIMETERS.

To convert millimeters into inches, multiply by 0.03937. To convert grams into ounces, multiply by 0.03527.

Cat. No. N148-E1-01 **In the interest of product improvement, specifications are subject to change without notice.**

OMRON Corporation

Industrial Automation Company

Industrial Devices and Components Division H.Q.

Industrial Control Components Department

Shiokoji Horikawa, Shimogyo-ku,

Kyoto, 600-8530 Japan

Tel: (81)75-344-7119/Fax: (81)75-344-7149