



technical hotline +44 (0)1268 563720

ingress protected | wiring devices

Polycarbonate Chemical Resistance Table

Key:

- ▲ Resistant
- Limited resistance
- Not resistant

REAGENT	CONCENTRATION	RESISTANCE
Acetic Acid, aqueous	40	■
Acetic acid, aqueous	5	▲
Acetone		■
Ammonia, aqueous	10	■
Benzene		■
Beverages, alcoholic		▲
Bitumen		Not tested
Bleaching lye, aqueous		■
Boric Acid	10	▲
Butanol		■
Butter		●
Butyric acid		■
Calcium chloride, aqueous	10	▲
Carbon tetrachloride		■
Chlorine gas		●
Chlorine, aqueous solution		■
Chloroform		■
Citric acid, aqueous	10	▲
Coconut oil		▲
Diesel fuel		●
Edible fats		▲
Edible oils		▲
Ethanol	96	▲
Ethylene acetate		■
Ethylene ether		■
Formaldehyde, aqueous	30	▲
Formic acid, aqueous	40	●
Freon, liquid		▲
Frigen, liquid		▲
Fruit juices		▲
Fuel oil (heating)		●
Gas liquor		Not tested
Glycerine		▲
Glycol		▲
Glystantine, aqueous	40	Not tested
Hexane		▲
Hydrochloric acid, aqueous	2	■
Hydrofluoric acid, aqueous	40	▲
Hydrogen peroxide, aqueous	10	▲
Ink		▲
Iodine tincture, alcoholic		■

REAGENT	CONCENTRATION	RESISTANCE
Kerosene		■
Lactic acid, aqueous	10	▲
Lavender oil		Not tested
Linseed oil		Not tested
Machine oils		▲
Mercury		▲
Methanol		■
Methylene chloride		■
Milk		▲
Mineral oils		▲
Nitric acid, aqueous	2	▲
Oleic acid		▲
Ozone		▲
Paraffin oil		▲
Peppermint oil		Not tested
Perfumes		■
Petrol (gasoline)		●
Phenol, aqueous		■
Phosphoric acid, aqueous	10	■
Potassium hydroxide solution, aqueous	5	■
Potassium hydroxide solution, aqueous	50	■
Rose oil		●
Salt solution, household, aqueous	10	▲
Silicon oils		▲
Soap solution, aqueous		▲
Soda solution, aqueous	10	▲
Sodium hydroxide solution, aqueous	10	■
Sodium, aqueous	10	Not tested
Sulphur		▲
Sulphuric acid, aqueous	10	▲
Tallow		▲
Tar		▲
Tetrachloroethene		■
Toluene		■
Trichlorethane		■
Vaseline		▲
Water		▲
Water, hot (80°C)		●
Wax, melted		Not tested
Xylene		■

For a full range of corresponding products, see pages 214-221 in the product selector.

13 Amp Socket Outlets

Standards and approvals

Socket outlets comply with BS 1363 Part 2: 1995.

All products allow compliance with BS 7671: 2008 when correctly installed.

Technical specification

Electrical

Voltage rating:
250V a.c.

Current rating:
13A per socket outlet

Terminal capacity:
Live, neutral & earth
3 x 2.5mm²
3 x 4mm²
2 x 6mm² (standard)

Physical

Ambient operating temperature:
0°C to +40°C

IP rating:
IP56

Max. installation altitude:
2000 metres

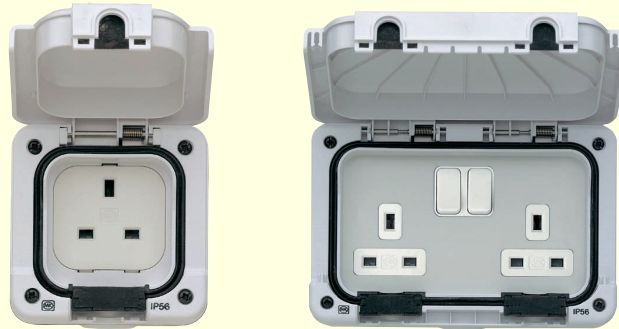

Description

A range of sockets outlets specifically designed for use outdoors or in areas heavily exposed to dust and/or splashing water. Constructed from extremely robust polycarbonate, the range is sealed to IP56 against dust, water and is impact resistant and will completely protect virtually any 13 amp plug* allowing safe connection to any appliance.

*When in doubt, please use an MK 13A plug or Duraplug.

Boxes

Rear entry back boxes (56504, 56505) are to be used in surface mounted situations or flush mounting when used with Flush Mounting Bezels

(56502, 1 gang / 56503, 2 gang). These boxes must also be used if cable or conduit enters the enclosure from the rear.

IP56 Protection

Each digit in the IP (Ingress Protection) rating denotes resistance to dust and water. The Masterseal IP56 rating breakdown is as follows:

IP	5	6
Ingress protection	Dustproof to sawdust, dust and other small particles	Waterproof to strong jets of water, any direction

Features

- IP56 protected to BS EN 60529: 1992
- Winner of Electrical Review industry awards
- Ideal for gardens, workshops, industry, farm buildings, ponds and pools etc.
- Easy to install: captive, backed out terminal screws, clearly marked top facing terminals, push fit knockouts and conduit entries
- Smooth, curved design is aesthetically pleasing and adds to strength
- Special gel seal gives complete protection
- Most products are available in grey or white enclosures to suit installation
- Impact resistance – all Masterseal products have impact resistance equivalent to a 500g object falling from a height of 400m
- 3 pin operated safety shutter on 13 Amp socket
- 3mm minimum switch contact gap
- Additional electrical safety from neutral 'make first, break last' feature
- Moulded 'on' indicator flash on switches will not rub off – totally safe
- Printed terminal markings on grey rear mouldings for clearer identification
- Top access, angled terminals make wiring easier and quicker
- Double pole switching
- Switch contacts with silver contacts on both surfaces for good continuity
- Backed out and captive terminal screws

Dimensions (mm)

1 gang / 2 gang with fixing dimensions

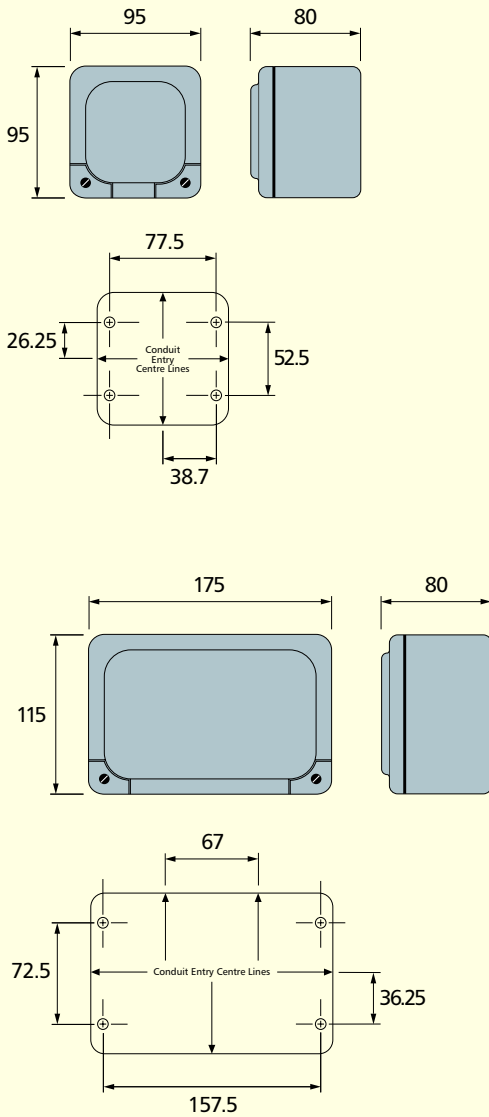

Flush Mounting Bezels

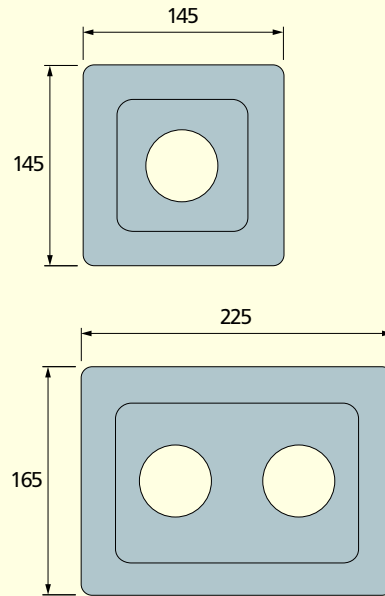

Flush Mounting Frames

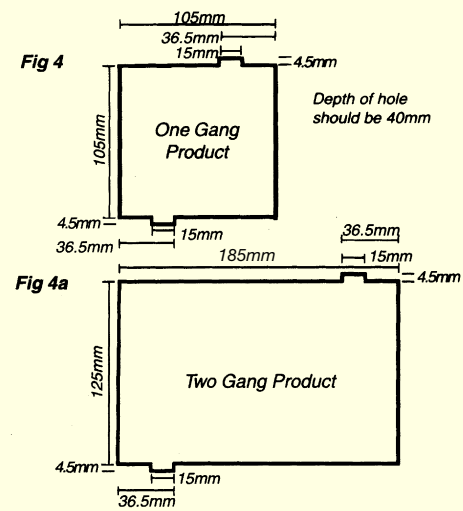

Timer Socket Outlet

Standards and approvals

Socket outlet complies with BS 1363 Part 2: 1995.

Enclosure conforms to BS EN 60529 IP56

Timer module complies with IEC 60730-1
IEC 60730-2-7, EN 55014 -1: 2000, EN 55022,
EN 61000-3-2, EN 61000-4-2, EN 61000-4-4,
EN 61000-4-5, EN 61000-4-6, EN 61000-4-11



Technical specification

Electrical

Supply Voltage	230V a.c.
Supply frequency	50Hz
Current rating for socket outlet	(RESISTIVE) 13A

Terminal capacity

Supply Line, Neutral and Earth	3 x 2.5mm ² 3 x 4 mm ² 2 x 6 mm ²
--------------------------------	--

Physical

Ambient operating temperature range: 0°C to +40°C
IP rating: IP56
Max. installation altitude: 2000 metres

Features

- Single 13A rated socket switched via the Single Pole timer module
- Weekly Electronic Timer
- 24 hour clock
- Multi-function Liquid Crystal Display (LCD)
- 6 ON/OFF programmes per day
- Individual day selection as well as 4 block day selections
- Supplied with a LOOP terminal in the back box, which has 5 entries for cables
- Override button to switch the load ON/OFF directly, bypassing the timer
- Impact resistance – all Masterseal products have impact resistance equivalent to a 500g object falling from a height of 400m

Description

This socket outlet, switched by a single pole timer module is specifically designed for use outdoors or in areas heavily exposed to dust and/or splashing water. Constructed from extremely robust polycarbonate, the product is sealed to IP56 against dust, water and is impact resistant. The product ensures a very high degree of protection for virtually any 13A plug* to BS 1363, allowing safe connection to electrical appliances, which can be switched on and off at pre-determined times.

Timer module

The product employs an electronic timer module, which switches the Supply Line to the socket outlet, via a single pole relay. 6 ON/OFF cycles per day can be programmed via the buttons on the face of the timer module. Days in the week can be set individually or set to repeat in 4 separate blocks as follows:

1. Monday to Friday
2. Saturday and Sunday
3. Monday to Saturday
4. Monday to Sunday

An Override button is available to switch the load ON/OFF directly, bypassing the timer.

Dimensions (mm)

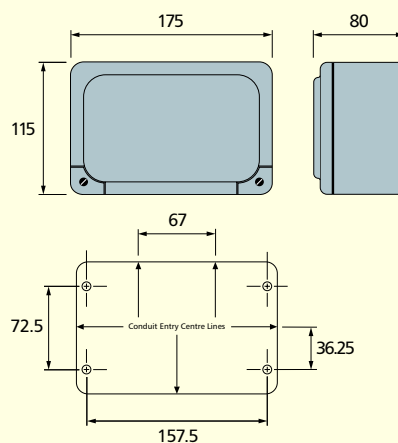

Boxes

Rear entry back box (56505) are to be used in surface mounted situations or flush mounting when used with Flush Mounting Bezel (56503). These boxes must also be used if cable or conduit enters the enclosure from the rear.

IP56 Protection

Each digit in the IP (Ingress Protection) rating denotes resistance to dust and water. The Masterseal IP56 rating breakdown is as follows:

* When in doubt, please use an MK 13A plug

IP	5	6
Ingress protection	Dustproof to sawdust, dust and other small particles	Waterproof to strong jets of water, any direction

Flush Mounting Bezel

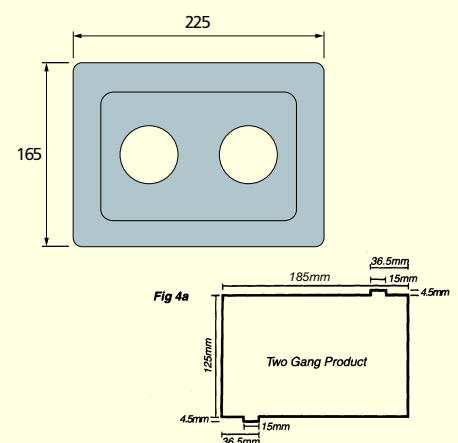



technical hotline +44 (0)1268 563720

ingress protected | wiring devices

Sentrysocket

Compliance with EC Directives, Standards and approvals

All Sentrysockets comply with the following EC Directives and are CE marked:
 Low Voltage Directive Electromagnetic Compatibility Directive (89/336/EEC)

Sentrysocket RCD Single Sockets also comply with the requirements of the following standards:
 BS 7288: 1990
 BS EN 50082-1: 1992

Sentrysocket RCD Double Sockets also comply with the requirements of the following standards:
 BS 7288: 1990
 BS EN 61543: 1996

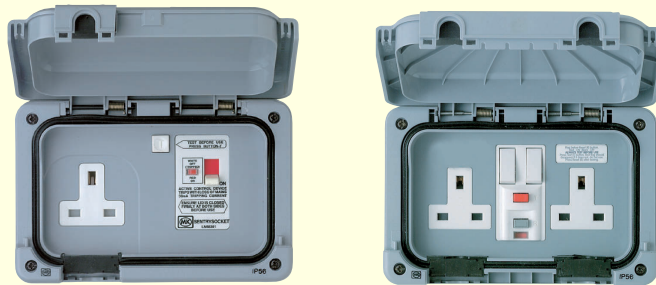

Technical specification

Electrical

Rated Voltage:
240V a.c.

Current rating:
13A resistive

Rated tripping current:
30mA

Terminal capacity:
3 x 4mm²

Physical

Ambient operating temperature:
0°C to +40°C

IP rating:
IP56

Max. installation altitude:
2000 metres

Features

- Suitable for most residential, commercial and light industrial applications
- Active and passive control circuit applications
- Comply fully with current Wiring Regulations if installed correctly
- Double pole switching
- Flexible and versatile in use
- Ideal for use with equipment subject to wet weather or high humidity
- They are a.c. and pulsating d.c. fault current sensitive

Description

Sentrysocket provides a high level of protection for portable equipment when used in damp environments or outdoors.

Active control circuits

Incorporate a 'Re-set' mechanism and are mains failure sensitive, i.e. they will function under all the normal conditions expected of an RCD, but will also trip in the event of a power cut or a sudden, dramatic reduction in mains voltage. This makes them ideal for use where it would be hazardous for equipment to suddenly energise after return of mains power, such as use with rotating machinery and heat developing apparatus.

Passive control circuit

Incorporates a 'Stay-set' mechanism and is mains failure proof, i.e. it will function under all the normal conditions expected of an RCD and will not trip in the event of a power cut. This makes it suitable for use with freezers or in inaccessible or unmanned locations.

Dimensions (mm)

Single and double sockets are identical in size and shape. The following dimensions apply

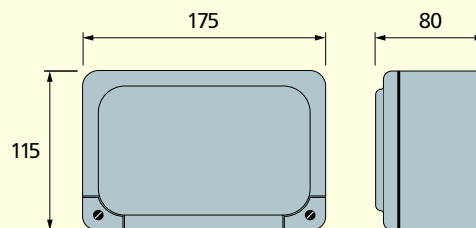

Masterseal Sentrysocket is suitable for surface mounting only.

Fixing Dimensions

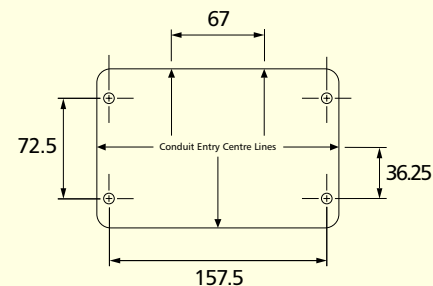

16A 2P+E German Socket Outlet

Standards and approvals

Complies with IEC 60884-1: 2006

Technical specification

Electrical

Voltage rating:
250V a.c.

Current rating:
16A

Terminal capacity:
Live, neutral & earth
4 x 1.5mm²
2 x 2.5mm²
1 x 4mm²

Physical

Ambient operating temperature:
0°C to +40°C
(not to exceed an average of more than 25°C in any
24 hour period)

IP rating:
IP56

Max. installation altitude:
2000 metres



Masterseal 16A 2P + E German socket outlet is suitable for surface mounting only.

Dimensions (mm)

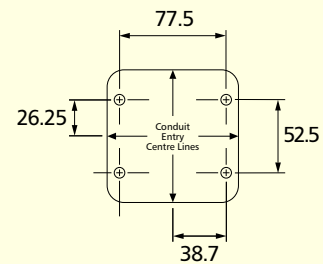
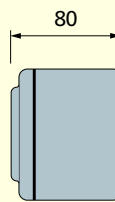
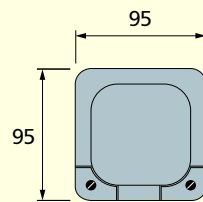

IP	5	6
Ingress protection	Dustproof to sawdust, dust and other small particles	Waterproof to strong jets of water, from any direction

Connection Units

Standards and approvals

All Masterseal Connection Units comply with BS 1363 Part 4: 1995. All units are fitted with a 13A fuse link to BS 1362.

Technical specification

Electrical

Voltage rating:
250V a.c.

Current rating:
Connection units – 13 amp

Terminal capacity:

Supply terminal: 2 x 6mm² stranded
3 x 4mm²
3 x 2.5mm²
3 x 1.5mm²

Load terminals: 1 x 1.5mm²

Physical

Ambient operating temperature:
–5°C to +40°C (not to exceed an average of more than 25°C in any 24 hour period)

IP rating:
IP56

Max. installation altitude:
2000 metres

Features

- IP56 protected to BS EN 60529: 1992
- Winner of Electrical Review industry awards
- Ideal for gardens, workshops, industry, farm buildings, swimming pools etc.
- Easy to install: captive, backed out terminal screws, clearly marked top facing terminals, push fit knockouts and conduit entries
- Smooth, curved design is aesthetically pleasing and adds to strength
- Special gel seal gives complete protection
- Switches have silver contacts
- Screw fitted fuse carrier
- Fuse carrier lockable in open position
- Captive fuse carrier
- Impact resistance – all Masterseal products have impact resistance equivalent to a 500g object falling from a height of 400m



Description

Masterseal connection units are specifically designed for use outdoors or in areas heavily exposed to dust and/or splashing water. Constructed from extremely robust polycarbonate, the range is sealed to IP56 against dust, water and is impact resistant and will completely protect and provide a safe connection to any appliance.

IP56 Protection

Each digit in the IP (Ingress Protection code) rating denotes resistance to dust and water. The Masterseal IP56 rating breakdown as is follows:

Impact Resistance

IP	5	6
Ingress protection	Dustproof to sawdust, dust and other small particles	Waterproof to strong jets of water, any direction

Dimensions (mm)

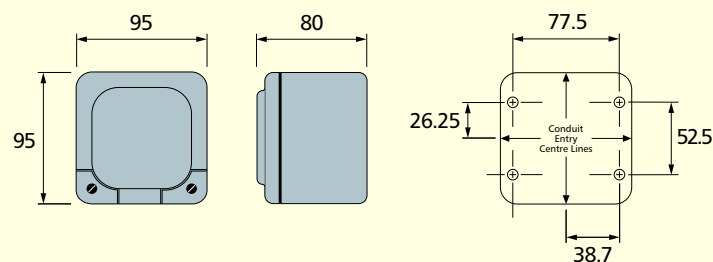

All Masterseal products have an impact resistance equivalent to a 500g object falling from a height of 40cm.

Boxes

Rear entry back boxes (56504) are to be used in 'tamper proof' surface mounted situations or flush mounting when used with Flush Mounting Bezels (56502). These boxes must also be used if cable or conduit enters the enclosure from the rear.

Installation

Masterseal connection units can be wall or bench mounted. Do not use on a trailing lead.

Switches

Standards and approvals

Switches and enclosures comply with BS EN 60669-1: 2000 and are IP56 for BS EN 60529: 1992.

20A Switch modules comply with BS EN 60669-1: 2000.

10A Switch modules comply with BS EN 60669-1: 2000.

All products comply with or allow compliance with BS 7671: 2008.

Technical specification

Electrical

Voltage rating:
250V a.c., 50 Hz

Current rating:
10 or 20 amps – no derating when used on fluorescent or inductive loads.

Load type:
No restriction

Physical

Ambient operating temperature:
0°C to +40°C

IP rating:
IP56

Max. installation altitude:
2000 metres

Features

- IP56 protected to BS EN 60529: 1992
- Ideal for gardens, workshops, industry, farm buildings, ponds and pools etc.
- Large, easy to use rocker switches
- Wide range of switch modules and accessories make Masterseal versatile
- Easy to install: captive, backed out terminal screws, clearly marked top facing terminals
- Switch modules snap into position
- Smooth, curved design is aesthetically pleasing and adds to strength
- Impact resistance – all Masterseal products have impact resistance equivalent to a 500g object falling from a height of 400m



Description

A range of switches and enclosures specifically designed for use outdoors or in areas heavily exposed to dust and/or splashing water. Constructed from extremely robust polycarbonate, the range is sealed to IP56 against dust, water and is impact resistant. Masterseal is easy to install and the large rocker switches and clip in modules make it easy to use, even when wearing heavy gloves.

IP56 Protection

Each digit in the IP (Ingress Protection) rating denotes resistance to dust and water. The Masterseal IP56 rating breakdown is as follows:

IP	5	6
Ingress protection	Dustproof to sawdust, dust and other small particles	Waterproof to strong jets of water, any direction

Dimensions (mm)

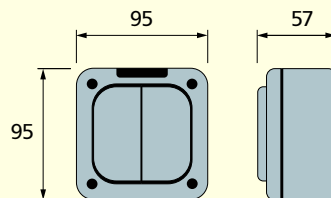

Fixing dimensions

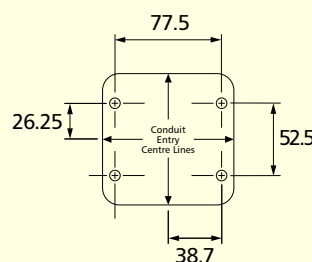

Impact Resistance

All Masterseal products have an impact resistance equivalent to a 500g object falling from a height of 40cm.

Boxes

Rear entry back boxes (56504) are to be used in surface mounted situations or flush mounting when used with Flush Mounting Bezels (56502). These boxes must also be used if cable or conduit enters the enclosure from the rear.

Flush Mounting Bezel

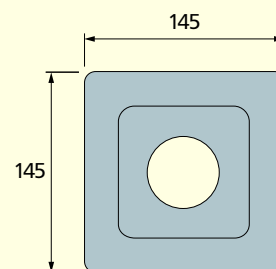

Flush Mounting Frame

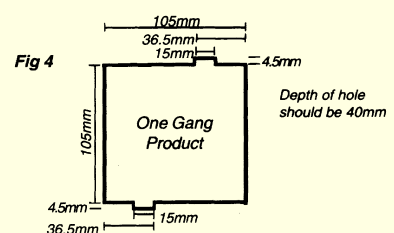

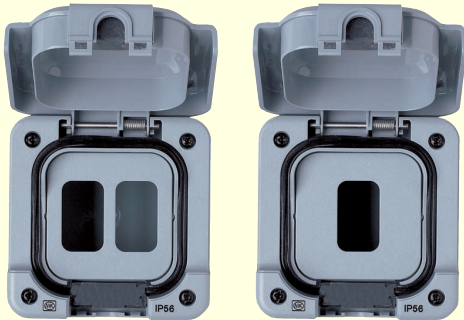

Customer Configurable Grid – 56414

- 1 Up to two wiring device modules may be selected from the MK Grid Plus modular range and fitted to the configurable grid enclosure.
- 2 If a TV outlet is to be fitted in combination with a mains voltage device, then it is essential that the cabling and modules are isolated from each other.
- 3 Grid modules are assembled into the front face of the front plate and clip firmly into position.
- 4 Two bezel mouldings are supplied. Select the appropriate bezel depending on whether one or two modules are fitted, locate in position and secure with the two screws provided as shown in Figure 1.

Figure 1

Fixing dimensions

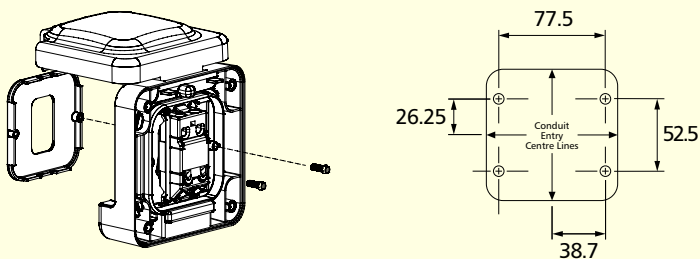

Photo Electric (Dusk/Dawn) Switch

Standards and approvals

IEC 60669-2-1

IP56 to BS EN 60529: 1992

BS EN 50081-1, BS EN 50082-1

Technical specification

Voltage Rating:
230V a.c. 50Hz

Current Rating:
Single pole 6 amp resistive
1000W Tungsten GLS
1000W Tungsten Halogen
1200W Fluorescent
(without PF correction).
100 μ f max. load capacitance.

NOMINAL LIGHT LEVEL
THRESHOLDS:
25 lux ON, 40 lux OFF

Optional timer adjustable from 1-15 hours (nominal)

Features

- IP56 protected to BS EN 60529: 1992
- Ideal for gardens, workshops, industry, farm buildings, ponds etc.
- Photo electric switch will automatically switch on at dusk and off at dawn
- Switch modules snap into position
- Smooth, curved design is aesthetically pleasing and adds to strength
- Impact resistance – all Masterseal products have impact resistance equivalent to a 500g object falling from a height of 400m



Description

Masterseal photo electric switch will automatically switch on at dusk and off at dawn. Alternatively, an optional user adjustable time period can be used to switch the load OFF before dawn, if required.

This product is not suitable for use with low energy, compact, fluorescent lamps.

IP56 Protection

Each digit in the IP (Ingress Protection) rating denotes resistance to dust and water. The Masterseal IP56 rating breakdown is as follows:

IP	5	6
Ingress protection	Dustproof to sawdust, dust and other small particles	Waterproof to strong jets of water, any direction

Dimensions (mm)

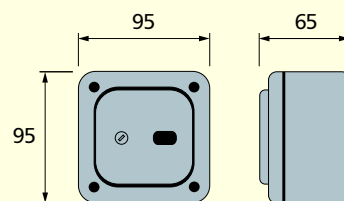

Fixing dimensions

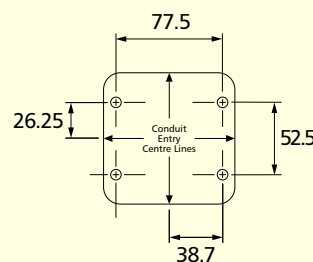

Impact Resistance

All Masterseal products have an impact resistance equivalent to a 500g object falling from a height of 40cm.

Boxes

Rear entry back boxes (56504) are to be used in surface mounted situations or flush mounting when used with Flush Mounting Bezels (56502). These boxes must also be used if cable or conduit enters the enclosure from the rear.

Flush Mounting Bezel

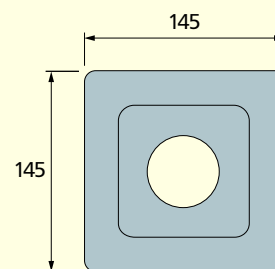

Flush Mounting Frame

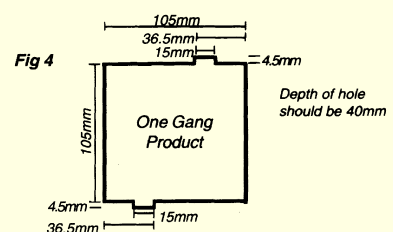



technical hotline +44 (0)1268 563720

ingress protected | wiring devices

Euro Enclosure and Telephone and Data Modules

Standards and approvals

Telephone sockets K5820 and K5821 comply with the following:
BS 6312: 2.2, OFTEL Approval NS/G/23/L/100005.

K5844/K5845/K5845s comply with:
BS EN 50173, IEC 11801, TIA/EIA 568A and TIA/EIA TSB40A.

K5887 complies with FCC68.



Technical specification

Installation tools required IDC Connectors (telephone & RJ45 outlets)

Electrical

Cable types:

Telephone: CW1311, CW1293, CW1308, CW1316

No. of cables per termination:

Telephone: 2

RJ11/12: 1

RJ45: 1

Termination type: IDC

Physical

Temperature range:

Ambient air 0°C to +40°C

IP rating: IP56 (enclosure)

Max. installation altitude: 2000 metres

Features

- IP56 data and telecoms protection
- Meet all relevant BS, OFTEL and cabling standards
- Interchangeable modules clip into enclosure
- Can be specified for all applications
- Impact resistance – all Masterseal products have impact resistance equivalent to a 500g object falling from a height of 400m

MODULE DIMENSIONS(mm)

25 x 50

IP

Ingress protection

5

Dustproof to sawdust, dust and other small particles

6

Waterproof to strong jets of water, any direction

Description

A range of Euro telephone, data and blank modules and weatherproof enclosure. Enclosure accommodates 2 modules providing care is used to ensure that the cables are correctly routed through the outlet.

Installation (Telephone socket modules)

Product performance, systems compatibility

Master Sockets: For use as the first socket outlet on a direct exchange. They contain the required surge protector (for line protection against electrical surges) and ringing capacitor.

Secondary Sockets: for use as extension sockets when connected on the same line as a Master Socket.

Installation tools required IDC Connectors (telephone & RJ45 outlets)

MK insertion tool List No. 400 or 22630.

Wire pull-out force: 10.5 Newtons when installed correctly.

Wiring regulation restrictions

Domestic Installations: The total REN (Ring Equivalent Number) value of all telephone equipment connected on a line must not exceed 4.

BT Wiring Scheme

- 1 GREEN / white
- 2 BLUE / white
- 3 ORANGE / white
- 4 WHITE / orange
- 5 WHITE / blue
- 6 WHITE / green

Note: Main wire colour is shown in capitals

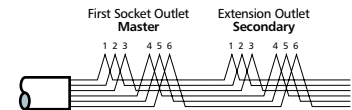
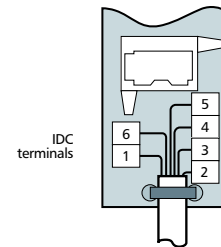

RJ11/12 Wiring Scheme

PIN NO.	STRIPPED COLOUR WIRE	SOLID COLOUR WIRE
1	WHITE / green	White
2	WHITE / orange	Black
3	BLUE / white	Red
4	WHITE / blue	Green
5	ORANGE / white	Yellow
6	GREEN / white	Blue

Note: Main wire colour is shown in capitals

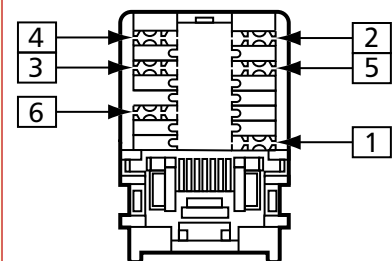

FOR RJ45 WIRING DIAGRAM, PLEASE REFER TO LOGIC PLUS TECHNICAL SECTION, PAGE 402

Socket Outlets / Switches

INSTALLATION OPTIONS

Flush mounting for plaster/tiled walls



Ideal for environments where hygiene is paramount, for example, hospitals and kitchens.

The Flush Mounting Frame is provided with spacers which are used to adjust the height of the box depending upon the depth of plaster, tiling or rendering to be applied to the mounting surface.

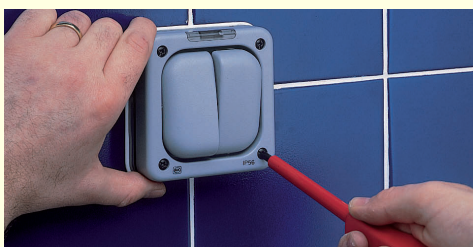
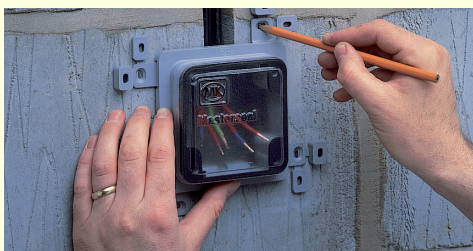

Surface mounting for rear entry

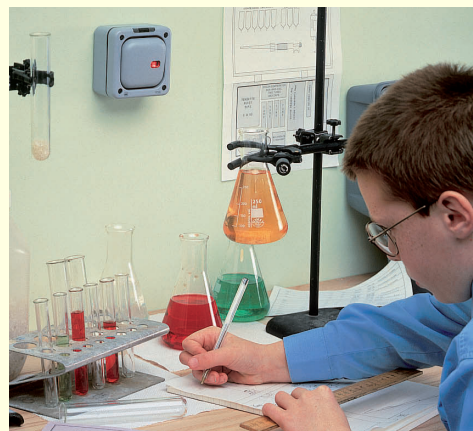

This option is for use in 'tamperproof' environments e.g. schools and public areas.

For this application the cable or conduit enters the Masterseal enclosure from the rear only (there are no side entries).



technical hotline +44 (0)1268 563720

ingress protected | wiring devices

Flush mounting for any finished surface



The bezel provides an alternative method of flush mounting in areas where hygiene is important e.g. food preparation areas.

This bezel can be used on any finished surface e.g. brick or cavity walls. The bezel should be used in conjunction with the rear entry back box.

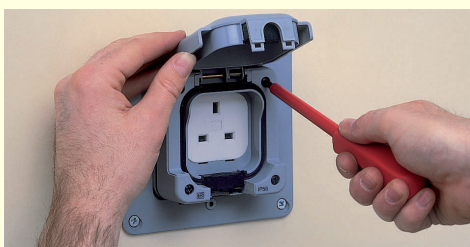
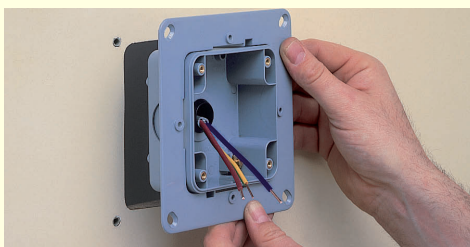

Surface mounting for side entry conduit



The basic Masterseal unit comes complete with a standard surface mounting back box. This enables top, bottom or side entry for the cable or conduit.

