

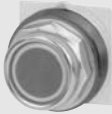

16 mm XB6



22 mm XB4



30 mm Type K



30 mm Type SK



30 mm Type KX



Type KY Enclosure



Pendant Stations



Type B Wall Station



XVL Compact Light



Type O Compact Light



Type J Compact Light

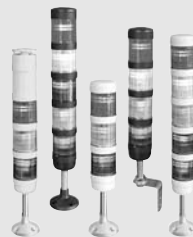

Indicating Banks



Type A Foot Switch

**22 and 30 mm Most Common Complete Operators**

Class 9001 Type K, SK—30 mm and XB4-XB5 22 mm most common complete operators assembled with contact blocks and suggested legend plates. Start-Stop and Hand-Of-Auto are just a few of the configurations offered in this simplified quick selector. **17-2**

**16 mm Push Buttons**

**XB6 16 mm Push Buttons**, selector switches, and pilot lights with a plastic bezel are intended for machine adjustment and set-up, such as conveyor systems and measuring equipment. **17-4**

**22 mm Push Buttons**

**XB4 22 mm Push Buttons**, selector switches, and pilot lights with a metal bezel are designed for industrial applications. They combine ease of installation and robustness. **17-15**

**XB5 22 mm** is the plastic version of the XB4 unit and is particularly suitable for applications requiring a resistance to chemical agents and/or double electrical insulation. **17-34**

**30 mm Push Buttons**

**Class 9001 Type K Heavy Duty Oiltight/Watertight Control Units and Stations** are intended primarily for machine tool and industrial applications. **17-55**

**Class 9001 Type SK Non-Metallic Watertight operators** are designed for use in highly corrosive areas. **17-68**

**Class 9001 Type KX operators** are Square Multifunction Control Units that mount in a Type K mounting hole. This highly versatile line saves space by combining push buttons and pilot lights into one common operator. **17-87**

**Class 9001 Type KY Heavy Duty Control Stations** are ideally suited for commercial and industrial applications. **17-102**

**Indicating Banks and Beacons**

**XVB and XVP Indicating Banks and Beacons** provide instant communication within work groups and across the factory floor. These highly visible, illuminated indicating banks of colored lights and audible alarms enable factory personnel to monitor and control production quality in large automated areas. They also provide 360° indication. **17-108**

**Pendant Stations**

Square D has a full line of pendant stations for most crane and hoist applications. Our pendants range from the light to medium duty **BW** and **XAC** pendants to the heavy duty **SKYP** pendants. **17-115**

**Compact Pilot Lights**

The Compact Pilot light ranges include the **Type J** pilot light, push-to-test and remote test types available in incandescent and LED. The **Type O** is a low cost incandescent and the **XVL** are miniature LED type. **17-106**

**Foot Switches**

The **Type A** foot switch is a heavy duty industrial foot switch which can be used in a variety of industrial applications. **17-120**

**Rotary Cam Switches – A New Extended Offer**

**K10, K2 and K30–K150 Rotary Cam Switches.** Miniature, Custom and Power Switching Cam Switches provide an inexpensive and versatile means of switching from 10 A logic control through 150 A power switching. **17-122**

**Control Stations & Enclosures**

**XAL** control stations are available pre-assembled or custom assembled. These control stations use push buttons and pilot lights from the **XB5** 22 mm range. **XAP** enclosures are available in glass reinforced polyester, die cast metal and flush mount. **17-95**

**Type B** Standard Duty Control Stations in 1, 2 and 3 button configurations are available as predetermined complete stations. **17-99**

# Push Buttons

Class 9001 Type K, SK—30 mm  
Common Operators, Complete with Contact Blocks



www.SquareD.com

For the most up-to-date information

## BLACK—Start Push Buttons

Operator Style	Description	Contact Block	Type	Price	Legend Plate	Price
30 mm Industrial (Metal)			KR1BH13	\$54.	KN201	\$2.90
30 mm Corrosion Resistant (Non-Metallic)			SKR1BH13	54.	KN101SP	2.90

## RED—Stop Push Buttons

Operator Style	Description	Contact Block	Type	Price	Legend Plate	Price
30 mm Industrial (Metal)			KR1RH13	\$54.	KN202	\$2.90
30 mm Corrosion Resistant (Non-Metallic)			SKR1RH13	54.	KN102RP	2.90

## BLACK—Off-On Selector Switch

Operator Style	Description	Contact Sequence (Contact Block Included)	Type	Price	Legend Plate	Price
30 mm Industrial (Metal)			KS11BH13	\$64.	KN244	\$2.90
30 mm Corrosion Resistant (Non-Metallic)			SKS11BH13	64.	KN144SP	2.90

## BLACK—Hand-Off-Auto Selector Switch

Operator Style	Description	Contact Sequence (Contact Block Included)	Type	Price	Legend Plate	Price
30 mm Industrial (Metal)			KS43BH13	\$64.	KN260	\$2.90
30 mm Corrosion Resistant (Non-Metallic)			SKS43BH13	64.	KN160SP	2.90

## RED—120 Vac—On Pilot Light

Operator Style	Description	Type	Price	Legend Plate	Price
30 mm Industrial (Metal)		KP1R31	\$102.	KN203	\$2.90
30 mm Corrosion Resistant (Non-Metallic)		SKP1R31	102.	KN103SP	2.90

## GREEN—120 Vac—Off Pilot Light

Operator Style	Description	Type	Price	Legend Plate	Price
30 mm Industrial (Metal)		KP1G31	\$102.	KN204	\$2.90
30 mm Corrosion Resistant (Non-Metallic)		SKP1G31	102.	KN104SP	2.90

## RED—120 Vac—On Push-To-Test Pilot Light

Operator Style	Description	Type	Price	Legend Plate	Price
30 mm Industrial (Metal)		KT1R31	\$131.	KN203	\$2.90
30 mm Corrosion Resistant (Non-Metallic)		SKT1R31	131.	KN103SP	2.90

## GREEN—120 Vac—Off Push-To-Test Pilot Light

Operator Style	Description	Type	Price	Legend Plate	Price
30 mm Industrial (Metal)		KT1G31	\$131.	KN204	\$2.90
30 mm Corrosion Resistant (Non-Metallic)		SKT1G31	131.	KN104RP	2.90



File E42259  
CCN NKCR







File LR 25490  
Class 3211 03







Marking

For additional information, reference Catalog #9001CT0001.





**BLACK—Start Push Buttons (flush head)**

Operator Style	Description	Contact Block	Type	Price	Legend Plate	Price
XB4 Die Cast Chrome		 1 N.O.	XB4BA21	\$17.50	ZBY2303	\$1.70
XB5 Double Insulated		 1 N.O.	XB5AA21	17.50	ZBY2303	1.70





**RED—Stop Push Buttons (extended head)**

Operator Style	Description	Contact Block	Type	Price	Legend Plate	Price
XB4 Die Cast Chrome		 1 N.C.	XB4BL42	\$17.50	ZBY2304	\$1.70
XB5 Double Insulated		 1 N.C.	XB5AL42	17.50	ZBY2304	1.70



**BLACK—Off-On Selector Switch**

Operator Style	Description	Contact Block	Type	Price	Legend Plate	Price
XB4 Die Cast Chrome		 1 N.O.	XB4BD21	\$23.00	ZBY2367	\$1.70
XB5 Double Insulated		 1 N.O.	XB5AD21	23.00	ZBY2367	1.70

**Hand-Off-Auto Selector Switch**

Operator Style	Description	Contact Block	Type	Price	Legend Plate	Price
XB4 Die Cast Chrome		 1 N.O.	XB4BD33	\$31.10	ZBY2387	\$1.70
XB5 Double Insulated		 2 N.O.	XB5AD33	31.10	ZBY2387	1.70





**RED—120 Vac LED—On Pilot Light**

Operator Style	Description	Light Module	Type	Price	Legend Plate	Price
XB4 Die Cast Chrome		120 Vac Red LED	XB4BVG4	\$32.40	ZBY2311	\$1.70
XB5 Double Insulated		120 Vac Red LED	XB5AVG4	32.40	ZBY2311	1.70





**GREEN—120 Vac LED—Off Pilot Light**

Operator Style	Description	Light Module	Type	Price	Legend Plate	Price
XB4 Die Cast Chrome		120 Vac Green LED	XB4BVG3	\$32.40	ZBY2312	\$1.70
XB5 Double Insulated		120 Vac Green LED	XB5AVG3	32.40	ZBY2312	1.70

**RED—40 mm Mushroom Emergency Stop (Push-Pull)**

Operator Style	Description	Contact Block	Type	Price	Legend Plate	Price
XB4 Die Cast Chrome		 1 N.C.	XB4BT42	\$31.20	ZBY9330	\$1.70
XB5 Double Insulated		 1 N.C.	XB5AT42	31.20	ZBY9330	1.70

**RED—40 mm Mushroom Emergency Stop (Turn-To-Release)**

Operator Style	Description	Contact Block	Type	Price	Legend Plate 60 mm Round	Price
XB4 Die Cast Chrome		 1 N.C.	XB4BS542	\$50.00	ZBY9330	\$1.70
XB5 Double Insulated		 1 N.C.	XB5AS542	50.00	ZBY9330	1.70



File E164353  
CCN NKCR



File LR 44087  
Class 3211 03



File E164353  
CCN NKCR 2

For additional information, reference Catalog #9001CT0001.

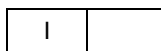

# Push Buttons—XB6 16 mm

## Characteristics and Complete Devices

### Characteristics

#### Environment

Conforming to standards	Marked	IEC 947-1, IEC 947-5-1, IEC 947-5-4, EN 60947-5-1, JIS C 4520 and 852, UL 508, CSA C22.2 No. 14
Product certifications	File E164353 CCN NKCR  File LR 44087 Class 3211 03	UL, CSA ASE, BV, JIS, RINA, LROS, DNV, GL: pending
Degree of protection	Conforming to IEC 529 & NF C 20-010 Conforming to UL 50 & CSA C22.2 No. 94	IP65 Type 1, 4, 4X and 12 (not for key selector switches)

#### Electrical characteristics of LED pilot lights

Voltage Limits, Current Draw	12–24 V	6–30 Vac/dc, 15 mA
	120 V	48–120 Vac, 20 mA

#### Electrical characteristics of contacts

Rated operational characteristics	AC-15	B300, Ue = 240 Vac and Ie = 1.5 A or Ue 120 Vac and Ie = 3 A Continuous Thermal Current 5 A
	DC-13	R300, Ue = 250 Vdc and Ie = 0.1 A or Ue = 125 Vdc and Ie = 0.22 A
Cabling		By Quick Connectors/Solder tabs 0.11 x 0.02 in. (2.8 x 0.5 mm)

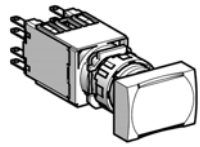

XB6DW...B

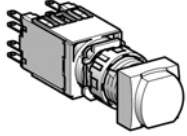

XB6CE...B

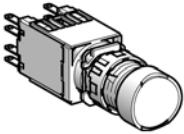

XB6AF...B

### Illuminated Push Buttons (12–24 Vac/Vdc LED included) Complete Units with Quick Connectors/Solder Tabs

Type of Push	Type of Contact		Color				Price		
	N.O.	N.C.		Rectangular	Square	Round			
	Catalog Number								
Flush, spring return	1	...	White	XB6DW1B1B	XB6CW1B1B	XB6AW1B1B	\$20.20		
			Green	XB6DW3B1B	XB6CW3B1B	XB6AW3B1B			
			Yellow	XB6DW5B1B	XB6CW5B1B	XB6AW5B1B			
			Blue	XB6DW6B1B	XB6CW6B1B	XB6AW6B1B			
	...	1	...	Red	XB6DW4B2B	XB6CW4B2B	XB6AW4B2B	20.20	
				White	XB6DW1B5B	XB6CW1B5B	XB6AW1B5B		
				Green	XB6DW3B5B	XB6CW3B5B	XB6AW3B5B		
				Red	XB6DW4B5B	XB6CW4B5B	XB6AW4B5B		
	1	1	1	Yellow	XB6DW5B5B	XB6CW5B5B	XB6AW5B5B	23.80	
				Blue	XB6DW6B5B	XB6CW6B5B	XB6AW6B5B		
				White	XB6DF1B1B	XB6CF1B1B	XB6AF1B1B		20.20
				Green	XB6DF3B1B	XB6CF3B1B	XB6AF3B1B		
Yellow	XB6DF5B1B	XB6CF5B1B	XB6AF5B1B						
Blue	XB6DF6B1B	XB6CF6B1B	XB6AF6B1B						
...	1	...	Red	XB6DF4B2B	XB6CF4B2B	XB6AF4B2B	20.20		
			White	XB6DF1B5B	XB6CF1B5B	XB6AF1B5B			
			Green	XB6DF3B5B	XB6CF3B5B	XB6AF3B5B			
			Red	XB6DF4B5B	XB6CF4B5B	XB6AF4B5B			
1	1	1	Yellow	XB6DF5B5B	XB6CF5B5B	XB6AF5B5B	23.80		
			Blue	XB6DF6B5B	XB6CF6B5B	XB6AF6B5B			
			White	XB6DE1B1B	XB6CE1B1B	XB6AE1B1B		20.20	
			Green	XB6DE3B1B	XB6CE3B1B	XB6AE3B1B			
Yellow	XB6DE5B1B	XB6CE5B1B	XB6AE5B1B						
Blue	XB6DE6B1B	XB6CE6B1B	XB6AE6B1B						
...	1	...	Red	XB6DE4B2B	XB6CE4B2B	XB6AE4B2B	20.20		
			White	XB6DE1B5B	XB6CE1B5B	XB6AE1B5B			
			Green	XB6DE3B5B	XB6CE3B5B	XB6AE3B5B			
			Red	XB6DE4B5B	XB6CE4B5B	XB6AE4B5B			
1	1	1	Yellow	XB6DE5B5B	XB6CE5B5B	XB6AE5B5B	23.80		
			Blue	XB6DE6B5B	XB6CE6B5B	XB6AE6B5B			

**Note:** Illuminated Push Buttons 120 Vac LED are available as Complete Units with Quick Connectors/Solder Tabs. Use 12–24 V table above. Change Voltage Code (2nd B) to "G". Example: XB6DW1B1B (White 24 V, 1 N.O.) becomes XB6DW1G1B.

For additional information, reference Catalog #9001CT0001.



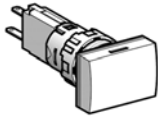

**XB6DV••B**

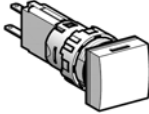

**XB6CV••B**

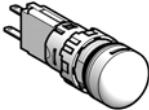

**XB6AV••B**

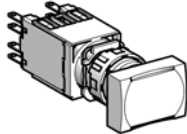

**XB6DA••B**

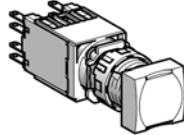

**XB6CA••B**

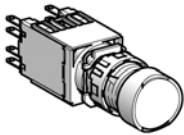

**XB6AA••B**



**XB6AS8345B**



**XB6AS9345B**



**ZB6Y7330**

**Pilot Lights (12–24 Vac/dc LED included)**  
**Complete Units with Quick Connectors/Solder Tabs**

Color	Rectangular	Square	Round	Price
	Catalog Number			
White	XB6DV1BB	XB6CV1BB	XB6AV1BB	\$12.40
Green	XB6DV3BB	XB6CV3BB	XB6AV3BB	
Red	XB6DV4BB	XB6CV4BB	XB6AV4BB	
Yellow	XB6DV5BB	XB6CV5BB	XB6AV5BB	
Blue	XB6DV6BB	XB6CV6BB	XB6AV6BB	

**Pilot Lights (120 Vac LED)**  
**Complete Units with Quick Connectors/Solder Tabs**

Color	Rectangular	Square	Round	Price
	Catalog Number			
White	XB6DV1GB	XB6CV1GB	XB6AV1GB	\$12.40
Green	XB6DV3GB	XB6CV3GB	XB6AV3GB	
Red	XB6DV4GB	XB6CV4GB	XB6AV4GB	
Yellow	XB6DV5GB	XB6CV5GB	XB6AV5GB	
Blue	XB6DV6GB	XB6CV6GB	XB6AV6GB	

**Push Buttons (Non-Illuminated)**  
**Complete Units with Quick Connectors/Solder Tabs**

Type of Push	Type of Contact		Color	Rectangular	Square	Round	Price
	N.O.	N.C.		Catalog Number			
Flush, spring return	1	...	White	XB6DA11B	XB6CA11B	XB6AA11B	\$11.90
			Black	XB6DA21B	XB6CA21B	XB6AA21B	
			Green	XB6DA31B	XB6CA31B	XB6AA31B	
			Yellow	XB6DA51B	XB6CA51B	XB6AA51B	
			Blue	XB6DA61B	XB6CA61B	XB6AA61B	
	...	1	Black	XB6DA22B	XB6CA22B	XB6AA22B	11.90
			Red	XB6DA42B	XB6CA42B	XB6AA42B	
	1	1	White	XB6DA15B	XB6CA15B	XB6AA15B	15.50
			Black	XB6DA25B	XB6CA25B	XB6AA25B	
			Green	XB6DA35B	XB6CA35B	XB6AA35B	
Red			XB6DA45B	XB6CA45B	XB6AA45B		
Yellow			XB6DA55B	XB6CA55B	XB6AA55B		
		Blue	XB6DA65B	XB6CA65B	XB6AA65B		

**Trigger Action Emergency Stop Mushroom Head Push Buttons (Color Red)▲**

Shape of Head	Type of Push	Type of Contact		Diameter of Head (mm)	Catalog Number	Price
		N.O.	N.C.			
●	Turn-to-release	...	1	30	XB6AS8342B	\$29.50
		1	1	30	XB6AS8345B	33.10
●	Key release	...	1	30	XB6AS9342B	35.70
		1	1	30	XB6AS9345B	39.30

▲ Trigger action mushroom heads are tamper proof in that a change of contact state is not possible by teasing or floating the operator.

**Circular Legends, 45 mm**

Description	Color	Text	Catalog Number	Price
Circular legends, 45 mm	Yellow	Blank	ZB6Y7001	\$1.70
		Emergency stop	ZB6Y7330	
		Arrêt d'urgence	ZB6Y7130	

For additional information, reference Catalog #9001CT0001.

### Selector Switches (Switching Angle: Handle: 60°, Key: 70°) Complete Units with Quick Connectors/Solder Tabs

Type of Operator	Type of Contact		Number and Type of Positions	Diagram	Rectangular	Square	Round	Price
	N.O.	N.C.			Catalog Number			
Handle	1	...	2-maintained		XB6DD221B	XB6CD221B	XB6AD221B	\$13.50
	1	1	2-maintained		XB6DD225B	XB6CD225B	XB6AD225B	17.10
			3-maintained		XB6DD235B	XB6CD235B	XB6AD235B	17.10
	2	...	3-maintained		XB6DD233B	XB6CD233B	XB6AD233B	17.10
Type of Operator	Type of Contact		Number and Type of Positions	Diagram	Rectangular	Square	Round	Price
	N.O.	N.C.			Catalog Number			
Key	1	1	2-maintained		XB6DGC5B	XB6CGC5B	XB6AGC5B	\$31.10
			2-maintained		XB6DGB5B	XB6CGB5B	XB6AGB5B	31.10
			3-maintained		XB6DGH5B	XB6CGH5B	XB6AGH5B	31.10
	2	...	3-maintained		XB6DGH3B	XB6CGH3B	XB6AGH3B	31.10

Indicates key withdrawal position.

#### Selector Switch Sequence

##### 2 Position Selector Switch

		Contact block guide ▲
O	X	1 N.O. (left or right)
X	O	1 N.C. (left or right)
O	X	1 N.O. and 1 N.C.
X	O	

##### 3 Position Selector Switch

			Contact block guide ▲
O	O	X	1 N.O. (left)
X	O	X	2 N.O. wired in <b>parallel</b> (side by side)
X	O	O	1 N.O. (right)
O	X	X	1 N.C. (right)
X	X	O	1 N.C. (left)
O	X	O	2 N.C. wired in <b>series</b> (side by side)

▲ As viewed from the front of the panel.

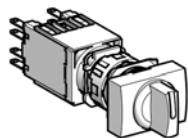

XB6DD\*\*\*B

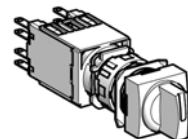

XB6CD\*\*\*B

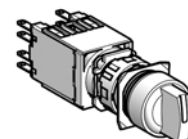

XB6AD\*\*\*B

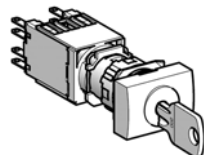

XB6DG\*\*B

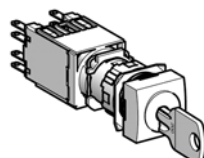

XB6CG\*\*B

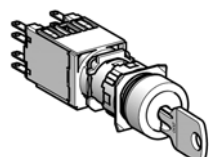

XB6AG\*\*B

For additional information, reference Catalog #9001CT0001.

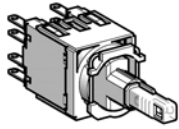

**ZB6ZB\*\*B**

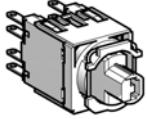

**ZB6ZH\*\*B**

**Contact Blocks and Light Modules for Illuminated Push Buttons▲**

Description	Supply Voltage	Type of Contact		Color of Light Source	Catalog Number	Price
		N.O.	N.C.			
<b>Quick connectors/solder tabs</b>						
Integral LED ■	12–24 Vac/dc	1	...	White Green Yellow Blue	ZB6ZB11B ZB6ZB31B ZB6ZB51B ZB6ZB61B	\$14.00
		...	1	Red Yellow	ZB6ZB42B ZB6ZB52B	14.00
		1	1	White Green Red Yellow Blue	ZB6ZB15B ZB6ZB35B ZB6ZB45B ZB6ZB55B ZB6ZB65B	17.60
	120 Vac	1	...	White Green Yellow Blue	ZB6ZG11B ZB6ZG31B ZB6ZG51B ZB6ZG61B	14.00
		...	1	Red Yellow	ZB6ZG42B ZB6ZG52B	14.00
		1	1	White Green Red Yellow Blue	ZB6ZG15B ZB6ZG35B ZB6ZG45B ZB6ZG55B ZB6ZG65B	17.60
Direct for incandescent bulb (not included)★	≤ 24 Vac/dc	1	...	...	ZB6ZH01B	11.90
		...	1	...	ZB6ZH02B	11.90
		1	1	...	ZB6ZH05B	15.50

**Contact Blocks for Push Buttons and Selector Switches**

Description	Type of Contact		Catalog Number	Price
	N.O.	N.C.		
<b>Quick connectors/solder tabs</b>				
Contact blocks with mounting base	1	...	ZB6Z1B	\$4.70
	...	1	ZB6Z2B	4.70
	2	...	ZB6Z3B	8.30
	...	2	ZB6Z4B	8.30
	1	1	ZB6Z5B	8.30

**Light Modules for Pilot Lights**

Description	Supply Voltage	Color of Light Source	Catalog Number	Price
<b>Quick connectors/solder tabs△</b>				
Integral LED◆	12–24 Vac/dc	White	ZB6EB1B	\$8.30
		Green	ZB6EB3B	
		Red	ZB6EB4B	
		Yellow	ZB6EB5B	
	120 Vac	Blue	ZB6EB6B	8.30
		White	ZB6EG1B	
With resistor for 95 V neon bulb (not included)★▼	110 Vac	...	ZB6EG0B	7.80
	230 Vac	...	ZB6EM0B	7.80
Direct supply for 0.6 W max. incandescent bulb (not included)★	≤ 24 Vac/dc	...	ZB6EH0B	7.20

**Separate Contact Blocks (Maximum of 3 contacts per mounting base.)**

Contact Material	For use with mounting base	Type of Contact		Catalog Number	Price
		N.O.	N.C.		
Silver alloy	Quick connectors/solder tabs	1	...	ZB6E1B	\$3.60
		...	1	ZB6E2B	3.60
Gold flashed	Quick connectors/solder tabs	1	...	ZB6E1E	6.20
		...	1	ZB6E2E	6.20

▲ It is possible to assemble illuminated selector switches by using a contact block/light module assembly in conjunction with a selector switch head, supplied without handle, and a transparent handle. See page 17-10.  
 ■ The LED must be the same color as the push button cap.  
 ◆ The LED must be the same color as the lens.  
 ★ Order bulbs separately. See page 17-14.  
 ▼ Neon bulb can only be used with red, yellow, or white cap.  
 △ Electrical components with connection by printed circuit board pins are available. Consult local field office for details.

For additional information, reference Catalog #9001CT0001.

**Heads for Illuminated Push Buttons**  
(To combine with complete bodies and contact blocks, see page 17-7)

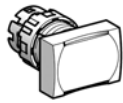

**ZB6DW•**

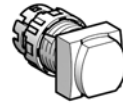

**ZB6CE•**



**ZB6AF•**

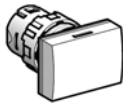

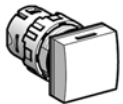

**ZB6DV•**



**ZB6CV•**





**ZB6AV•**

Type of Push	Color				Price
		Rectangular	Square	Round	
Flush, spring return	White	ZB6DW1	ZB6CW1	ZB6AW1	<b>7.20</b>
	Green	ZB6DW3	ZB6CW3	ZB6AW3	
	Red	ZB6DW4	ZB6CW4	ZB6AW4	
	Yellow	ZB6DW5	ZB6CW5	ZB6AW5	
	Blue	ZB6DW6	ZB6CW6	ZB6AW6	
	5 colors ▲	ZB6DW9	ZB6CW9	ZB6AW9	<b>8.20</b>
Flush, maintained	Without cap ■	ZB6DW0	ZB6CW0	ZB6AW0	<b>6.20</b>
	White	ZB6DF1	ZB6CF1	ZB6AF1	<b>7.20</b>
	Green	ZB6DF3	ZB6CF3	ZB6AF3	
	Red	ZB6DF4	ZB6CF4	ZB6AF4	
	Yellow	ZB6DF5	ZB6CF5	ZB6AF5	
	Blue	ZB6DF6	ZB6CF6	ZB6AF6	
5 colors ▲	ZB6DF9	ZB6CF9	ZB6AF9	<b>8.20</b>	
Extended, spring return	Without cap ■	ZB6DF0	ZB6CF0	ZB6AF0	<b>6.20</b>
	White	ZB6DE1	ZB6CE1	ZB6AE1	<b>7.20</b>
	Green	ZB6DE3	ZB6CE3	ZB6AE3	
	Red	ZB6DE4	ZB6CE4	ZB6AE4	
	Yellow	ZB6DE5	ZB6CE5	ZB6AE5	
	Blue	ZB6DE6	ZB6CE6	ZB6AE6	
5 colors ▲	ZB6DE9	ZB6CE9	ZB6AE9	<b>8.20</b>	
	Without cap ■	ZB6DE0	ZB6CE0	ZB6AE0	<b>6.20</b>

▲ Five different color caps included with head (white, green, red, yellow, and blue).  
■ To order push button caps separately, see page 17-12.

**Heads for Pilot Lights**  
(To combine with light modules, see page 17-7.)

Color				Price
	Rectangular	Square	Round	
	<b>Catalog Number</b>			
White	ZB6DV1	ZB6CV1	ZB6AV1	<b>4.10</b>
Green	ZB6DV3	ZB6CV3	ZB6AV3	
Red	ZB6DV4	ZB6CV4	ZB6AV4	
Yellow	ZB6DV5	ZB6CV5	ZB6AV5	
Blue	ZB6DV6	ZB6CV6	ZB6AV6	
5 colors ♦	ZB6DV9	ZB6CV9	ZB6AV9	<b>5.10</b>
Without lens★	ZB6DV0	ZB6CV0	ZB6AV0	<b>3.10</b>

♦ Five different color caps included with head (white, green, red, yellow, and blue).  
★ To order the caps or lenses separately, see page 17-12.

For additional information, reference Catalog #9001CT0001.



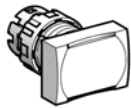

**ZB6DA•**

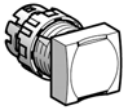

**ZB6CA•**



**ZB6AA•**



**ZB6AC•**



**ZB6AS834**



**ZB6AS934**



**ZB6Y7330**

**Heads for Push Buttons**  
 (To combine with complete bodies and contact blocks, see page 17-7.)

Type of Push	Color	Rectangular	Square	Round	Price
		Catalog Number			
Flush, spring return	White	ZB6DA1	ZB6CA1	ZB6AA1	\$7.20
	Black	ZB6DA2	ZB6CA2	ZB6AA2	
	Green	ZB6DA3	ZB6CA3	ZB6AA3	
	Red	ZB6DA4	ZB6CA4	ZB6AA4	
	Yellow	ZB6DA5	ZB6CA5	ZB6AA5	
	Blue	ZB6DA6	ZB6CA6	ZB6AA6	
	6 colors▲	ZB6DA9	ZB6CA9	ZB6AA9	8.20
Extended, spring return	Without cap ■	ZB6DW0	ZB6CW0	ZB6AW0	6.20
	Red	ZB6DL4	ZB6CL4	ZB6AL4	7.20

▲ Five different color caps included with head (white, green, red, yellow, and blue).  
 ■ To order push button caps separately, see page 17-12.

**Mushroom Heads for Push Buttons (24 mm)**

Shape of Head	Type of Push	Color of Cap	Catalog Number	Price
	Spring return	White	ZB6AC1	\$12.40
		Black	ZB6AC2	
		Green	ZB6AC3	
		Yellow	ZB6AC5	
		Blue	ZB6AC6	

**Mushroom Heads for Trigger Action Push Buttons (30 mm)♦**

Shape of Head	Type of Push	Color of Cap	Catalog Number	Price
	Turn-to-release	Red	ZB6AS834	\$24.80
	Key release	Red	ZB6AS934	31.10

**Circular Legends, 45 mm**

Description	Color	Text	Catalog Number	Price
Circular legends, 45 mm	Yellow	Blank	ZB6Y7001	\$1.70
		Emergency stop	ZB6Y7330	
		Arrêt d'urgence	ZB6Y7130	

♦ Trigger action mushroom heads are tamper proof in that a change of contact state is not possible by teasing or floating the operator.

For additional information, reference Catalog #9001CT0001.

# Push Buttons—XB6 16 mm

## Selector Switches



www.SquareD.com

For the most up-to-date information

### Heads for Non-Illuminated Selector Switches ▲◆ (To combine with complete bodies and contact blocks, see page 17-7.)

Number and Type of Positions	Color of Handle	Rectangular	Square	Round	Price	
		Catalog Number				
<b>Switching angle: maintained positions 60°, spring return positions 45°</b>						
2-maintained		Black	ZB6DD22	ZB6CD22	ZB6AD22	<b>\$8.80</b>
2-maintained		Black	ZB6DD28 ■	ZB6CD28 ■	ZB6AD28 ■	
3-maintained		Black	ZB6DD23	ZB6CD23	ZB6AD23	
2-spring return to center		Black	ZB6DD24	ZB6CD24	ZB6AD24	
3-spring return to center		Black	ZB6DD25	ZB6CD25	ZB6AD25	
3-spring return from right to center		Black	ZB6DD26	ZB6CD26	ZB6AD26	
3-spring return from left to center		Black	ZB6DD27	ZB6CD27	ZB6AD27	



ZB6DD\*\*



ZB6CD\*\*



ZB6AD\*\*

▲ For bodies with 2 contact blocks, maximum.  
 ■ Switching angle: maintained positions 90°.  
 ◆ See selector switch sequence charts on page 17-11.

### Heads for Illuminated Selector Switches ★△ (To combine with complete bodies and contact blocks, see page 17-7.)

Number and Type of Positions		Rectangular	Square	Round	Price	
		Catalog Number				
<b>Switching angle: maintained positions 60°, spring return positions 45°</b>						
2-maintained			ZB6DD02	ZB6CD02	ZB6AD02	<b>\$6.70</b>
2-maintained			ZB6DD08 ▼	ZB6CD08 ▼	ZB6AD08 ▼	
3-maintained			ZB6DD03	ZB6CD03	ZB6AD03	
2-spring return to center			ZB6DD04	ZB6CD04	ZB6AD04	
3-spring return to center			ZB6DD05	ZB6CD05	ZB6AD05	
3-spring return from right to center			ZB6DD06	ZB6CD06	ZB6AD06	
3-spring return from left to center			ZB6DD07	ZB6CD07	ZB6AD07	



ZB6DD0\*



ZB6CD0\*



ZB6AD0\*

★ Order handle separately (see below), for bodies with 2 contact blocks, maximum.  
 ▼ Switching angle: maintained positions 90°.  
 △ See selector switch sequence charts on page 17-11.

### Handles for Illuminated Selector Switches

Description	Color	Catalog Number	Price
Handles for illuminated selector switches □	White	ZB6YK1	<b>\$2.10</b>
	Green	ZB6YK3	
	Red	ZB6YK4	
	Yellow	ZB6YK5	
	Blue	ZB6YK6	



ZB6YK\*

### Handles for Non-Illuminated Selector Switches







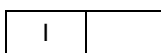



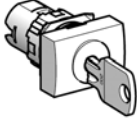



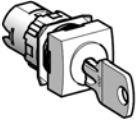



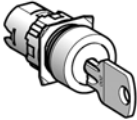

Description	Color	Catalog Number	Price
Handles for non-illuminated selector switches	Black	ZB6YD2	<b>\$2.10</b>
	Red	ZB6YD4	

□ For use in conjunction with head without handle (see above) and body/contact assembly for illuminated push buttons (see page 17-7).

For additional information, reference Catalog #9001CT0001.







**Heads for Ronis Key Operated Selector Switches**  
(To combine with complete bodies and contact blocks, see page 17-7.)

Number and Type of Positions	Key Withdrawal	Rectangular	Square	Round	Price
		Catalog Number			
<b>Switching angle: maintained positions 70°, spring return positions 45°</b>					
 ZB6DG• 2-maintained	 Right-hand position	ZB6DGA	ZB6CGA	ZB6AGA	\$22.80
	 Center position	ZB6DGB	ZB6CGB	ZB6AGB	
	 Both positions	ZB6DGC	ZB6CGC	ZB6AGC	
 ZB6CG• 3-maintained	 Center position	ZB6DGL	ZB6CGL	ZB6AGL	
	 Left-hand position	ZB6DGD	ZB6CGD	ZB6AGD	
	 Center position	ZB6DGE	ZB6CGE	ZB6AGE	
 ZB6AG• 3-spring return from left to center	 Left-hand and center positions	ZB6DGF	ZB6CGF	ZB6AGF	
	 Right-hand position	ZB6DGG	ZB6CGG	ZB6AGG	
	 All 3 positions	ZB6DGH	ZB6CGH	ZB6AGH	
	 Left-hand and right-hand positions	ZB6DGJ	ZB6CGJ	ZB6AGJ	
	 Right-hand and center positions	ZB6DGK	ZB6CGK	ZB6AGK	
3-spring return from left to center	 Right-hand position	ZB6DGM	ZB6CGM	ZB6AGM	
	 Center position	ZB6DGN	ZB6CGN	ZB6AGN	
	 Right-hand and center positions	ZB6DGP	ZB6CGP	ZB6AGP	
3-spring return from right to center	 Left-hand position	ZB6DQ	ZB6CGQ	ZB6AGQ	
	 Center position	ZB6DGR	ZB6CGR	ZB6AGR	
	 Left-hand and center positions	ZB6DGS	ZB6CGS	ZB6AGS	
3-spring return to center	 Center position	ZB6DGT	ZB6CGT	ZB6AGT	

 Indicates key withdrawal position.

**Selector Switch Sequence (using contact block assemblies, page 17-7)**

2 Position Selector Switch		
		Contact block guide▲
O	X	1 N.O. (left or right)
X	O	1 N.C. (left or right)
O	X	1 N.O. and
X	O	1 N.C.

3 Position Selector Switch			
			Contact block guide▲
O	O	X	1 N.O. (left)
X	O	X	2 N.O. wired in <b>parallel</b> (side by side)
X	O	O	1 N.O. (right)
O	X	X	1 N.C. (right)
X	X	O	1 N.C. (left)
O	X	O	2 N.C. wired in <b>series</b> (side by side)

▲ As viewed from the front of the panel.

For additional information, reference Catalog #9001CT0001.

# Push Buttons—XB6 16 mm

## Accessories



### Push Button Caps—Unmarked

Application	Color				Price
		Rectangular	Square	Round	
Catalog Number					
Illuminated push buttons with flush push	White	ZB6YDW1	ZB6YCW1	ZB6YAW1	\$1.00
	Green	ZB6YDW3	ZB6YCW3	ZB6YAW3	
	Red	ZB6YDW4	ZB6YCW4	ZB6YAW4	
	Yellow	ZB6YDW5	ZB6YCW5	ZB6YAW5	
	Blue	ZB6YDW6	ZB6YCW6	ZB6YAW6	
Illuminated push buttons with extended push	White	ZB6YDE1	ZB6YCE1	ZB6YAE1	1.00
	Green	ZB6YDE3	ZB6YCE3	ZB6YAE3	
	Red	ZB6YDE4	ZB6YCE4	ZB6YAE4	
	Yellow	ZB6YDE5	ZB6YCE5	ZB6YAE5	
	Blue	ZB6YDE6	ZB6YCE6	ZB6YAE6	
Non-illuminated push buttons	White	ZB6YDA1	ZB6YCA1	ZB6YAA1	1.00
	Black	ZB6YDA2	ZB6YCA2	ZB6YAA2	
	Green	ZB6YDA3	ZB6YCA3	ZB6YAA3	
	Red	ZB6YDA4	ZB6YCA4	ZB6YAA4	
	Yellow	ZB6YDA5	ZB6YCA5	ZB6YAA5	
	Blue	ZB6YDA6	ZB6YCA6	ZB6YAA6	

### Lens Caps

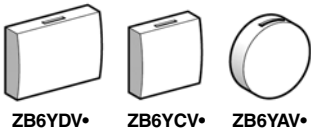

Application	Color				Price
		Rectangular	Square	Round	
Catalog Number					
Pilot lights	White	ZB6YDV1	ZB6YCV1	ZB6YAV1	\$1.00
	Green	ZB6YDV3	ZB6YCV3	ZB6YAV3	
	Red	ZB6YDV4	ZB6YCV4	ZB6YAV4	
	Yellow	ZB6YDV5	ZB6YCV5	ZB6YAV5	
	Blue	ZB6YDV6	ZB6YCV6	ZB6YAV6	

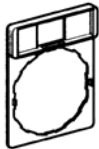

ZB6YD20

### Standard Legend Plate (24 X 28 mm) for 8 X 21 mm Legend

Description	Background Color of Legend	Catalog Number	Price
Without legend insert	...	ZB6YD20	\$1.00
With blank legend insert	White or yellow	ZB6YD21	1.70
	Black or red	ZB6YD22	1.70



ZB6Y2178



ZB6Y2304











### 8 x 21 mm Marked Legends (for 24 x 28 mm legend holder ZB6YD20)

Color	Marking	Catalog Number	Price
White Text Red Background (Stop and Fault) Black Background (all others)	International	O-I	ZB6Y2178
		I-II	ZB6Y2179
		I-O-II	ZB6Y2186
		←O→	ZB6Y2190
	English	HAND-O-AUTO	ZB6Y2387
		CLOSE	ZB6Y2314
		DOWN	ZB6Y2308
		FORWARD	ZB6Y2305
		FAULT	ZB6Y2334
		LEFT	ZB6Y2310
		OFF	ZB6Y2312
		ON	ZB6Y2303
		OPEN	ZB6Y2313
		RESET	ZB6Y2323
		REVERSE	ZB6Y2306
		RIGHT	ZB6Y2309
		RUN	ZB6Y2311
		STOP	ZB6Y2304
		UP	ZB6Y2307

For additional information, reference Catalog #9001CT0001.



**Push Button Caps—Marked**

Ink Marking Color: White on colored cap Black on white cap	Color				Price	
		Catalog Number				
<b>For non-illuminated push buttons</b>						
 ZB6YD•10	0	White	ZB6YD100	ZB6YC100	ZB6YA100	\$2.10
	Black	ZB6YD200	ZB6YC200	ZB6YA200		
 ZB6YC•10	1	White	ZB6YD101	ZB6YC101	ZB6YA101	
	Black	ZB6YD201	ZB6YC201	ZB6YA201		
 ZB6YA•10	2	White	ZB6YD102	ZB6YC102	ZB6YA102	
	Black	ZB6YD202	ZB6YC202	ZB6YA202		
 ZB6YD•17	3	White	ZB6YD103	ZB6YC103	ZB6YA103	
	Black	ZB6YD203	ZB6YC203	ZB6YA203		
 ZB6YD•19	4	White	ZB6YD104	ZB6YC104	ZB6YA104	
	Black	ZB6YD204	ZB6YC204	ZB6YA204		
 ZB6YC•19	5	White	ZB6YD105	ZB6YC105	ZB6YA105	
	Black	ZB6YD205	ZB6YC205	ZB6YA205		
 ZB6YA•19	6	White	ZB6YD106	ZB6YC106	ZB6YA106	
	Black	ZB6YD206	ZB6YC206	ZB6YA206		
ON	7	White	ZB6YD107	ZB6YC107	ZB6YA107	
	Black	ZB6YD207	ZB6YC207	ZB6YA207		
OFF	8	White	ZB6YD108	ZB6YC108	ZB6YA108	
	Black	ZB6YD208	ZB6YC208	ZB6YA208		
I	9	White	ZB6YD109	ZB6YC109	ZB6YA109	
	Black	ZB6YD209	ZB6YC209	ZB6YA209		
O	ON	White	ZB6YD117	ZB6YC117	ZB6YA117	
	Green	ZB6YD317	ZB6YC317	ZB6YA317		
R	Black	ZB6YD224	ZB6YC224	ZB6YA224		
	Red	ZB6YD424	ZB6YC424	ZB6YA424		
START	White	ZB6YD111	ZB6YC111	ZB6YA111		
	Green	ZB6YD311	ZB6YC311	ZB6YA311		
STOP	Black	ZB6YD210	ZB6YC210	ZB6YA210		
	Red	ZB6YD410	ZB6YC410	ZB6YA410		
II	Black	ZB6YD226	ZB6YC226	ZB6YA226		
	Blue	ZB6YD626	ZB6YC626	ZB6YA626		
III	White	ZB6YD140	ZB6YC140	ZB6YA140		
	Green	ZB6YD340	ZB6YC340	ZB6YA340		
+	Black	ZB6YD241	ZB6YC241	ZB6YA241		
	Red	ZB6YD441	ZB6YC441	ZB6YA441		
-	White	ZB6YD112	ZB6YC112	ZB6YA112		
	Black	ZB6YD212	ZB6YC212	ZB6YA212		
UP	White	ZB6YD113	ZB6YC113	ZB6YA113		
	Black	ZB6YD213	ZB6YC213	ZB6YA213		
DOWN	White	ZB6YD114	ZB6YC114	ZB6YA114		
	Black	ZB6YD214	ZB6YC214	ZB6YA214		
CLOSE	White	ZB6YD115	ZB6YC115	ZB6YA115		
	Black	ZB6YD215	ZB6YC215	ZB6YA215		
↑	White	ZB6YD127	ZB6YC127	ZB6YA127		
	Black	ZB6YD227	ZB6YC227	ZB6YA227		
↓	White	ZB6YD128	ZB6YC128	ZB6YA128		
	Black	ZB6YD228	ZB6YC228	ZB6YA228		
→	White	ZB6YD132	ZB6YC132	ZB6YA132		
	Black	ZB6YD232	ZB6YC232	ZB6YA232		
←	White	ZB6YD119	ZB6YC119	ZB6YA119		
	Black	ZB6YD219	ZB6YC219	ZB6YA219		
↕	White	ZB6YD120	ZB6YC120	ZB6YA120		
	Black	ZB6YD220	ZB6YC220	ZB6YA220		
↔	White	ZB6YD121	ZB6YC121	ZB6YA121		
	Black	ZB6YD221	ZB6YC221	ZB6YA221		
↔	White	ZB6YD122	ZB6YC122	ZB6YA122		
	Black	ZB6YD222	ZB6YC222	ZB6YA222		

For additional information, reference Catalog #9001CT0001.

# Push Buttons—XB6 16 mm

## Accessories



ZB6Y009

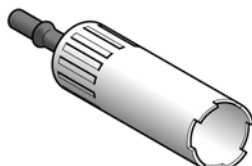

ZB6Y905



ZB6Y002



ZB6Y003

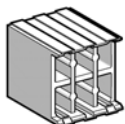

ZB6Y001

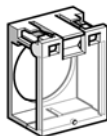

ZB6YA001

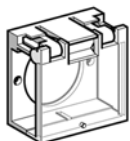

ZB6YD001



ZB6Y005



ZB6Y007



ZB6Y7330

### Accessories

Description	Application	Catalog Number	Price
Body	Fitting contact blocks	ZB6Y009	\$1.00
Bezel tightening tool + bulb extractor	Fixing the switch and changing bulbs	ZB6Y905	2.10
Cap extractor	Changing caps	ZB6Y016	2.10
Contact block removal tool	Removing contact blocks	ZB6Y018	2.10
Three piece tool kit	...	ZB6Y019	6.20
Nut	Fixing head to panel	ZB6Y002	1.00
Anti-rotation plate	Selector switches, Emergency Stops	ZB6Y003	1.00
Adaptor	Flush mounting a circular head push button or pilot light in Ø 22 mm cut-out	ZB6YA002	3.10
Shroud	Protecting contacts against touching	ZB6Y001	1.70
Protective cover	Circular and square head push buttons and switches	ZB6YA001	8.30
	Rectangular head push buttons and switches	ZB6YD001	8.30
Female Quick connector/Solder tab	Sold in lots of 100 pieces	ZB6Y004	0.21
Blanking plug	Plugging an unused knockout	ZB6Y005	2.10
Ronis key, 2 pieces	Key operated selector switches and emergency stop mushroom	ZB6Y007	3.10
Incandescent bulbs, bayonet T1 1/4	6 V	ZB6YA006	1.00
	12 V	ZB6YJ012	1.00
	28 V ▲	ZB6YB028	1.00
Neon bulbs	110/230 V ■	ZB6YG095	2.10
Link	Operation of 3rd contact	ZB6Y017	0.52
SIS Label Software	Legend Design Software: English, French, German, Spanish, Italian	XBY2U	52.00
Sheets of peel-off legends, 66 legends per sheet. For use with SIS label, size A4 (297 mm x 210 mm)	Pilot lights, rectangular	ZB6YD003	3.10
	Pilot lights, square	ZB6YC003	
	Pilot lights, circular	ZB6YA003	
	Illuminated push buttons, rectangular	ZB6YD013	
	Illuminated push buttons, square	ZB6YC013	
	Illuminated push buttons, circular	ZB6YA013	



▲ 28 V bulb supplied, for use on 24 V.  
 ■ 95 V bulb supplied, for use on 110/230 V.

### Circular Legends, 45 mm

Description	Color	Text	Catalog Number	Price
Circular legends, 45 mm	Yellow	Blank	ZB6Y7001	\$1.70
		Emergency stop	ZB6Y7330	
		Arrêt d'urgence	ZB6Y7130	

For additional information, reference Catalog #9001CT0001.

**Environment**

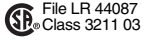
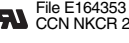
<b>Degree of protection</b>	Conforming to IEC 529	IP65, unless otherwise stated IP66, for booted push button heads
	Conforming to UL 50 and CSA C22.2 No. 94	Type 1, 2, 3, 4, 4X, 12, and 13, unless otherwise stated
<b>Conforming to standards</b>	 Marked	IEC 947-1, IEC/EN 60947-5-1, IEC 947-5-4, EN 60947-1, JIS C 4520, UL 508, CSA C22.2 No. 14
<b>Product certifications</b>	UL Listed, CSA	Standard single contacts with screw clamp terminals: A600; Q600 Double contacts with screw clamp terminals: A600; Q600 Light modules with screw clamp terminals JOYSTICK XD4-PA: A600; R300
	 File E164353 CCN NKCR  File LR 44087 Class 3211 03  File E164353 CCN NKCR 2	Standard single contacts and double contacts with screw clamp terminals
	BV, RINA, LROS, DNV, GL (pending)	

**Electrical Characteristics of Operators and Contact Blocks**

<b>Cabling capacity</b>	Conforming to IEC 947-1	Screw and captive clamp terminals Min: 1 x 24 AWG (0.22 mm <sup>2</sup> ) without cable end 1 x 22 AWG (0.34 mm <sup>2</sup> ) for linking Max: 2 x 16 AWG (1.5 mm <sup>2</sup> ) with cable end 2 x 14 AWG (2.5 mm <sup>2</sup> ) without cable ends Cross headed screw (POZIDRIV type 1) slotted for flat 4 and 5.5 mm screwdriver		
<b>Maximum Contact Block Usage</b>	XB4/ZB4 Maximum Number of Blocks	Push buttons (Non-Illuminated)	9	
		Selector switches (Non-Illuminated)	6	
		Push buttons and selectors (Illuminated)	6	
		Mushrooms, Push Pull (Non-Illuminated)	6	
		Mushrooms, Push Pull (Illuminated)	4	
		Mushrooms, Turn-to-Release (Non-Illuminated)	6	
		Mushrooms, Trigger Action (Non-Illuminated)	4	
		Push-on/Push-off (Non-Illuminated)	3	
<b>Rated operational characteristics Conforming to IEC/EN 60947-5-1</b>	AC supply: Utilization category AC-15	Standard blocks (single or double) with screw clamp terminals: A600: Ue = 600 Vac and Ie = 1.2 A or Ue = 240 Vac and Ie = 3 A or Ue = 120 Vac and Ie = 6 A Continuous Thermal Current: 10 A		
	DC supply: Utilization category DC-13	Standard single or double blocks with screw clamp terminals: Q600: Ue = 600 Vdc and Ie = 0.1 A or Ue = 250 Vdc and Ie = 0.27 A or Ue = 125 Vdc and Ie = 0.55 A Joystick XD4-PA: R300: Ue = 125 Vdc and Ie = 0.22 A or Ue = 250 Vdc and Ie = 0.1 A		
<b>Electrical durability Conforming to IEC/EN 60947-5-1 Appendix C Operating rate 3600 operating cycles/hour. Load factor: 0.5</b>	AC supply for 1 million operating cycles, utilization category AC-15	Standard blocks for screw clamp terminals:		
		24 Vac	120 Vac	230 Vac
		4 A	3 A	2 A
		Standard double blocks with screw clamp terminals:		
	24 Vac	120 Vac	230 Vac	
	3 A	1.5 A	1 A	
	DC supply for 1 million operating cycles, utilization category DC-13	Standard single blocks for screw clamp terminals:		
		24 Vdc	110 Vdc	
0.5 A		0.2 A		
Standard double blocks with screw clamp terminals:				
24 Vdc	110 Vdc			
0.4 A	0.15 A			

**Electrical Characteristics of Light Modules**

<b>Cabling capacity</b>	Conforming to IEC 947-1	Screw and captive clamp terminals Min: 1 x 24 AWG (0.22 mm <sup>2</sup> ) without cable end 1 x 22 AWG (0.34 mm <sup>2</sup> ) for linking Max: 2 x 16 AWG (1.5 mm <sup>2</sup> ) with cable end
-------------------------	-------------------------	---

**Specific Characteristics of Protected LED® Light Modules Only**

<b>Voltage limits</b>	Nominal voltage	24 V: 19.2 to 30 Vdc, 21.6 to 26.4 Vac; 120 V: 102 to 132 Vac; 240 V: 195 to 264 Vac
<b>Current consumption</b>	Applicable to all colors	24 Vac/dc supply blocks: 18 mA 120 Vac supply blocks: 14 mA 240 Vac supply blocks: 14 mA

For additional information, reference Catalog #9001CT0001.



**XB4BA31**

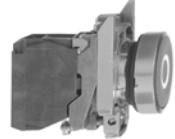

**XB4BA4322**



**XB4BP51**



**XB4BL42**





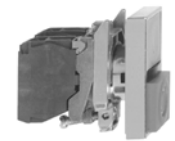



**XB4BC21**



**XB4BL845**

**Non-Illuminated Push Buttons, Momentary (screw clamp terminal connections)**

Shape of Head	Type of Push	Type of Contact		Marking	Color of Cap	Catalog Number (Components)	Price	
		N.O.	N.C.					
	Flush	1	...	...	Black	XB4BA21 (ZB4BZ101 + ZB4BA2)	\$17.50	
					Green	XB4BA31 (ZB4BZ101 + ZB4BA3)		
					Yellow	XB4BA51 (ZB4BZ101 + ZB4BA5)		
					Blue	XB4BA61 (ZB4BZ101 + ZB4BA6)		
		...	1	...	...	Red	XB4BA42 (ZB4BZ102 + ZB4BA4)	17.50
		1	1	...	Black	XB4BA25 (ZB4BZ105 + ZB4BA2)	25.60	
					Green	XB4BA35 (ZB4BZ105 + ZB4BA3)		
					Red	XB4BA45 (ZB4BZ105 + ZB4BA4)		
Yellow	XB4BA55 (ZB4BZ105 + ZB4BA5)							
Blue	XB4BA65 (ZB4BZ105 + ZB4BA6)							
	Flush	1	...	"I" (white)	Green	XB4BA3311 (ZB4BZ101 + ZB4BA331)	20.30	
	Flush	...	1	"O" (white)	Red	XB4BA4322 (ZB4BZ102 + ZB4BA432)	20.30	
	Flush with clear silicone boot (color of pusher unobscured)	1	...	...	Black	XB4BP21 (ZB4BZ101 + ZB4BP2)	23.90	
					Green	XB4BP31 (ZB4BZ101 + ZB4BP3)		
					Yellow	XB4BP51 (ZB4BZ101 + ZB4BP5)		
					Blue	XB4BP61 (ZB4BZ101 + ZB4BP6)		
...	1	...	...	Red	XB4BP42 (ZB4BZ102 + ZB4BP4)	23.90		
	Extended	...	1	...	Red	XB4BL42 (ZB4BZ102 + ZB4BL4)	17.50	
		1	1	...	Red	XB4BL45 (ZB4BZ105 + ZB4BL4)	25.60	
	Mushroom head Ø 40 mm	1	...	...	Black	XB4BC21 (ZB4BZ101 + ZB4BC2)	25.70	

**Two Button Push Buttons, Momentary (screw clamp terminal connections)**

Shape of Head	Type of Push	Type of Contact		Degree of Protection	Catalog Number (Components)	Price
		N.O.	N.C.			
	One flush green push (marked "I") One extended red push (marked "O")	1	1	IP40	XB4BL845 (ZB4BZ105 + ZB4BL8434)	\$31.50

For additional information, reference Catalog #9001CT0001.

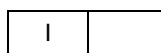



**Non-Illuminated Emergency Stop Mushroom Head Push Buttons, Ø 40 mm (Red)**  
(screw clamp terminal connections)



**XB4BT845**



**XB4BS9445**



**XB4BS542**

Shape of Head	Type of Push	Type of Contact		Number and Type of Positions	Catalog Number (Components)	Price
		N.O.	N.C.			
	Trigger action push-pull▲	1	1		XB4BT845 (ZB4BZ105 + ZB4BT84)	\$46.00
	Trigger action turn-to-release▲	1	1		XB4BS8445 (ZB4BZ105 + ZB4BS844)	75.00
	Trigger action Key release ▲ (No. 455)	1	1		XB4BS9445 (ZB4BZ105 + ZB4BS944)	75.00
	Push-pull	...	1		XB4BT42 (ZB4BZ102 + ZB4BT4)	31.20
	Turn-to-release	...	1		XB4BS542 (ZB4BZ102 + ZB4BS54)	50.00
	Key release (No. 455)	...	1		XB4BS142 (ZB4BZ102 + ZB4BS14)	67.00

▲ Trigger action mushroom heads are tamper proof in that a change of contact state is not possible by teasing or floating the operator.

**Non-Illuminated Selector Switches and Key Switches (screw clamp terminal connections)**



**XB4BD33**



**XB4BJ33**



**XB4BG33**

Shape of Head	Type of Operator	Type of Contact		Number and Type of Positions	Catalog Number (Components)	Price	
		N.O.	N.C.				
	Standard lever, black	1	...	2-maintained		XB4BD21 (ZB4BZ101 + ZB4BD2)	\$23.00
		1	1	2-maintained		XB4BD25 (ZB4BZ105 + ZB4BD2)	31.10
		2	...	3-maintained		XB4BD33 (ZB4BZ103 + ZB4BD3)	31.10
				3-momentary to center		XB4BD53 (ZB4BZ103 + ZB4BD5)	33.80
	Extended lever, black	1	...	2-maintained		XB4BJ21 (ZB4BZ101 + ZB4BJ2)	23.00
		2	...	3-maintained		XB4BJ33 (ZB4BZ103 + ZB4BJ3)	31.10
					3-momentary to center		XB4BJ53 (ZB4BZ103 + ZB4BJ5)
	Key (No. 455)	1	...	2-maintained		XB4BG21 (ZB4BZ101 + ZB4BG2)	55.80
						2-momentary to left	
		2	...	3-maintained		XB4BG03 (ZB4BZ103 + ZB4BG0)	63.90
						3-maintained	

The symbol indicates key withdrawal position(s)

For additional information, reference Catalog #9001CT0001.



**XB4BVB5**



**Pilot Lights with PROTECTED LED® (screw clamp terminal connections)**

Shape of Head	Supply Voltage	Color	Catalog Number (Components)	Price
	24 Vac/dc	White	XB4BVB1 (ZB4BVB1 + ZB4BV013)	<b>\$32.40</b>
		Green	XB4BVB3 (ZB4BVB3 + ZB4BV033)	
		Red	XB4BVB4 (ZB4BVB4 + ZB4BV043)	
		Yellow	XB4BVB5 (ZB4BVB5 + ZB4BV053)	
		Blue	XB4BVB6 (ZB4BVB6 + ZB4BV063)	
	110–120 Vac	White	XB4BVG1 (ZB4BVG1 + ZB4BV013)	<b>32.40</b>
		Green	XB4BVG3 (ZB4BVG3 + ZB4BV033)	
		Red	XB4BVG4 (ZB4BVG4 + ZB4BV043)	
		Yellow	XB4BVG5 (ZB4BVG5 + ZB4BV053)	
		Blue	XB4BVG6 (ZB4BVG6 + ZB4BV063)	



**XB4BV64**





**Pilot Lights for BA9s Bulb (screw clamp terminal connections)**

Shape of Head	Supply Voltage	Color	Catalog Number (Components)	Price
<b>Direct supply, for BA9s (incandescent, LED, neon) V ≤ 250 V, 2.4 W bulb (bulb not included)</b>				
	≤ 250 Vac/dc	White	XB4BV61 (ZB4BV6 + ZB4BV01)	<b>\$23.10</b>
		Green	XB4BV63 (ZB4BV6 + ZB4BV03)	
		Red	XB4BV64 (ZB4BV6 + ZB4BV04)	
		Yellow	XB4BV65 (ZB4BV6 + ZB4BV05)	
<b>Transformer type with 1.2 VA, 6 V secondary. BA9s incandescent bulb included</b>				
	110–120 Vac 50/60 Hz	White	XB4BV31 (ZB4BV3 + ZB4BV01)	<b>53.00</b>
		Green	XB4BV33 (ZB4BV3 + ZB4BV03)	
		Red	XB4BV34 (ZB4BV3 + ZB4BV04)	
		Yellow	XB4BV35 (ZB4BV3 + ZB4BV05)	



**XB4BV33**

**Illuminated Push Buttons, Momentary (screw clamp terminal connections)**

Shape of Head	Description	Type of Contact		Supply Voltage	Color of Push	Catalog Number (Components)	Price
		N.O.	N.C.				
<b>Flush</b>							
	Protected LED	1	1	24 Vac/dc	White	XB4BW31B5 (ZB4BW0B15 + ZB4BW313)	<b>\$54.00</b>
					Green	XB4BW33B5 (ZB4BW0B35 + ZB4BW333)	
					Red	XB4BW34B5 (ZB4BW0B45 + ZB4BW343)	
					Yellow	XB4BW35B5 (ZB4BW0B55 + ZB4BW353)	
					Blue	XB4BW36B5 (ZB4BW0B65 + ZB4BW363)	
				110–120 Vac	White	XB4BW31G5 (ZB4BW0G15 + ZB4BW313)	<b>54.00</b>
					Green	XB4BW33G5 (ZB4BW0G35 + ZB4BW333)	
					Red	XB4BW34G5 (ZB4BW0G45 + ZB4BW343)	
					Yellow	XB4BW35G5 (ZB4BW0G55 + ZB4BW353)	
					Blue	XB4BW36G5 (ZB4BW0G65 + ZB4BW363)	
	Direct supply for BA9s 2.4 W max. bulb not included	1	1	≤ 250 Vac/dc	White	XB4BW3165 (ZB4BW065 + ZB4BW31)	<b>44.90</b>
					Green	XB4BW3365 (ZB4BW065 + ZB4BW33)	
					Red	XB4BW3465 (ZB4BW065 + ZB4BW34)	
					Yellow	XB4BW3565 (ZB4BW065 + ZB4BW35)	
	Transformer type 1.2 VA, 6 V secondary. BA9s incandescent bulb included	1	1	110–120 Vac 50/60 Hz	White	XB4BW3135 (ZB4BW035 + ZB4BW31)	<b>74.00</b>
					Green	XB4BW3335 (ZB4BW035 + ZB4BW33)	
					Red	XB4BW3435 (ZB4BW035 + ZB4BW34)	
					Yellow	XB4BW3535 (ZB4BW035 + ZB4BW35)	
					Blue	XB4BW3635 (ZB4BW035 + ZB4BW36)	
				230–240 Vac 50/60 Hz	White	XB4BW3145 (ZB4BW045 + ZB4BW31)	<b>74.00</b>
					Green	XB4BW3345 (ZB4BW045 + ZB4BW33)	
					Red	XB4BW3445 (ZB4BW045 + ZB4BW34)	
					Yellow	XB4BW3545 (ZB4BW045 + ZB4BW35)	
					Blue	XB4BW3645 (ZB4BW045 + ZB4BW36)	
<b>Extended</b>							
	Protected LED	1	1	24 Vac/dc	White	XB4BW11B5 (ZB4BW0B15 + ZB4BW113)	<b>51.40</b>
					Green	XB4BW13B5 (ZB4BW0B35 + ZB4BW133)	
					Red	XB4BW14B5 (ZB4BW0B45 + ZB4BW143)	
					Yellow	XB4BW15B5 (ZB4BW0B55 + ZB4BW153)	
					Blue	XB4BW16B5 (ZB4BW0B65 + ZB4BW163)	
				110–120 Vac	White	XB4BW11G5 (ZB4BW0G15 + ZB4BW113)	<b>51.40</b>
					Green	XB4BW13G5 (ZB4BW0G35 + ZB4BW133)	
					Red	XB4BW14G5 (ZB4BW0G45 + ZB4BW143)	
					Yellow	XB4BW15G5 (ZB4BW0G55 + ZB4BW153)	
					Blue	XB4BW16G5 (ZB4BW0G65 + ZB4BW163)	

For additional information, reference Catalog #9001CT0001.

**Non-Illuminated Operators, Momentary—Unmarked**



**ZB4BA0**



**ZB4BA4**



**ZB4BA38**



**ZB4BP18**



**ZB4BL1**



**ZB4BA36**

Shape of Head	Type of Push	Color of Cap	Catalog Number	Price
	Flush, without color cap ▲	...	ZB4BA0	\$5.50
	Flush, with set of 6 color caps	White Black Green Red Yellow Blue	ZB4BA9	6.50
	Flush	White	ZB4BA1	6.50
		Black	ZB4BA2	
		Green	ZB4BA3	
		Red	ZB4BA4	
		Yellow	ZB4BA5	
		Blue	ZB4BA6	
	Flush with transparent cap, for insertion of legend ■	Gray	ZB4BA8	8.00
		White	ZB4BA18	
		Green	ZB4BA38	
		Red	ZB4BA48	
		Yellow	ZB4BA58	
		Blue	ZB4BA68	
	Booted (clear) Color of cap unobscured	White	ZB4BP1	12.90
		Black	ZB4BP2	
		Green	ZB4BP3	
		Red	ZB4BP4	
		Yellow	ZB4BP5	
		Blue	ZB4BP6	
	Booted (clear) for insertion of legend ■ Color of cap unobscured	White	ZB4BP18	14.50
		Green	ZB4BP38	
		Red	ZB4BP48	
		Yellow	ZB4BP58	
		Blue	ZB4BP68	
			Extended	
Black	ZB4BL2			
Green	ZB4BL3			
Red	ZB4BL4			
Yellow	ZB4BL5			
Blue	ZB4BL6			
	Guarded Head	White	ZB4BA16	17.50
		Black	ZB4BA26	
		Green	ZB4BA36	
		Red	ZB4BA46	
		Yellow	ZB4BA56	
		Blue	ZB4BA66	

▲ Color cap to be ordered separately, see page 17-31.  
■ For legend ordering information, see page 17-31.

**Non-Illuminated Operators, Momentary—Premarked**



**ZB4BA331**



**ZB4BA334**



**ZB4BL432**

Shape of Head	Type of Push	Marking Text	Color	Color of Cap	Catalog Number	Price
	Flush	I	White	Green	ZB4BA331	\$9.30
			Black	White	ZB4BA131	
		START	White	Green	ZB4BA333	
			Black	White	ZB4BA133	
		ON	White	Green	ZB4BA341	
			Black	White	ZB4BA141	
		RESET	White	Black	ZB4BA222	
		JOG	White	Black	ZB4BA245	
		O	White	Red	ZB4BA432	
			Black	Black	ZB4BA232	
		STOP	White	Red	ZB4BA434	
			Black	Black	ZB4BA234	
OFF	White	Red	ZB4BA435			
	Black	Black	ZB4BA235			
↑ ◆	Black	White	ZB4BA334			
	White	Black	ZB4BA335			
	Extended	O	White	Red	ZB4BL432	9.30
			Black	Black	ZB4BL232	
		STOP	White	Red	ZB4BL434	
			Black	Black	ZB4BL234	
		OFF	White	Red	ZB4BL435	
			Black	Black	ZB4BL235	

◆ Cap supplied not clipped-in, allowing orientation of arrow in 4 directions: ↑, ↓, ← or →

For additional information, reference Catalog #9001CT0001.

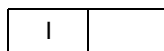



**ZB4BC24**



**ZB4BC2**



**ZB4BR2**



**ZB4BH02**



**ZB4BA8134**



**ZB4BL8312**





**ZB4BL9312**





**Mushroom Heads, Momentary**

Shape of Head	Diameter of Head	Color of Head	Catalog Number	Price
	30 mm	Black	ZB4BC24	<b>\$14.70</b>
		Green	ZB4BC34	
		Red	ZB4BC44	
		Yellow	ZB4BC54	
		Blue	ZB4BC64	
	40 mm	Black	ZB4BC2	<b>14.70</b>
		Green	ZB4BC3	
		Red	ZB4BC4	
		Yellow	ZB4BC5	
		Blue	ZB4BC6	
	60 mm	Black	ZB4BR2	<b>17.50</b>
		Green	ZB4BR3	
Red		ZB4BR4		
Yellow		ZB4BR5		
Blue		ZB4BR6		

**Non-Illuminated Push-on/Push-off Operators**

Shape of Head	Type of Push	Color of Push	Catalog Number	Price
	Flush	White	ZB4BH01	<b>\$8.80</b>
		Black	ZB4BH02	
		Green	ZB4BH03	
		Red	ZB4BH04	
		Yellow	ZB4BH05	
		Blue	ZB4BH06	
	Extended	White	ZB4BH1	<b>8.80</b>
		Black	ZB4BH2	
		Green	ZB4BH3	
		Red	ZB4BH4	
		Yellow	ZB4BH5	
		Blue	ZB4BH6	

**Two Head Operators, Momentary**

Shape of Head	Description	Color of Pushers	Degree of Protection▲	Catalog Number	Price
<b>No Marking</b>					
	Two flush	Green	IP40	ZB4BA8134	<b>\$10.40</b>
		Red	IP66	ZB4BA9134	<b>18.60</b>
		White	IP40	ZB4BA8112	<b>10.40</b>
		Black	IP66	ZB4BA9112	<b>18.60</b>
	One flush One extended	Green	IP40	ZB4BL8334	<b>10.40</b>
		Red	IP66	ZB4BL9334	<b>18.60</b>
		White	IP40	ZB4BL8312	<b>10.40</b>
		Black	IP66	ZB4BL9312	<b>18.60</b>
<b>Premarked</b>					
	Two flush (marked "I") (marked "O")	Green	IP40	ZB4BA8234	<b>12.40</b>
		Red	IP66	ZB4BA9234	<b>20.70</b>
		White	IP40	ZB4BA8212	<b>12.40</b>
		Black	IP66	ZB4BA9212	<b>20.70</b>
	One flush (marked "I") One extended (marked "O")	Green	IP40	ZB4BL8434	<b>12.40</b>
		Red	IP66	ZB4BL9434	<b>20.70</b>
		White	IP40	ZB4BL8412	<b>12.40</b>
		Black	IP66	ZB4BL9412	<b>20.70</b>

▲ IP66 version utilizes boot (included).

For additional information, reference Catalog #9001CT0001.



**ZB4BS834**



**ZB4BT4**



**ZB4BS64**



**ZB4BS74**

**Mushroom Heads for Maintained Push Buttons**

Shape of Head	Type of Push	Diameter of Head	Color	Catalog Number	Price
	Trigger action Push-pull ■	40 mm	Red	ZB4BT84	\$26.90
	Trigger action Turn-to-release ■	30 mm	Red	ZB4BS834	56.00
		40 mm	Red	ZB4BS844	56.00
	Trigger action Key release (No. 455) ▲ ■	30 mm	Red marked "EMO"	ZB4BS84430	59.00
		30 mm	Red	ZB4BS934	56.00
		40 mm	Red	ZB4BS944▲	56.00
	Key release (No. 455) ▲ ■	40 mm	Red	ZB4BS964	56.00
		60 mm	Red	ZB4BS964	56.00
		60 mm	Red	ZB4BS964	56.00
	Push-pull	40 mm	Black	ZB4BT2	20.20
		40 mm	Red	ZB4BT4	
	Push-pull	60 mm	Black	ZB4BX2	23.00
		60 mm	Red	ZB4BX4	
	Turn-to-release	30 mm	Black	ZB4BS42	39.00
			Red	ZB4BS44	
		40 mm	Black	ZB4BS52	39.00
			Red	ZB4BS54	
			Red marked "EMO"	ZB4BS5430	42.40
			Yellow	ZB4BS55	39.00
		60 mm	Yellow marked "Robot Stop"	ZB4BS5550	42.40
			Black	ZB4BS62	44.80
		30 mm	Red	ZB4BS64	
			Black	ZB4BS72	
40 mm	Red	ZB4BS74	56.00		
	Black	ZB4BS12			
60 mm	Red	ZB4BS14▲	56.00		
	Black	ZB4BS22			
60 mm	Red	ZB4BS24	56.00		
	Black	ZB4BS24			

▲ Other key numbers:  
 —key no. 421E: add the suffix 12 to the catalog number.  
 —key no. 458A: add the suffix 10 to the catalog number.  
 —key no. 520E: add the suffix 14 to the catalog number.  
 —key no. 3131A: add the suffix 20 to the catalog number.  
 Example:  
 The catalog number for a Ø 40 mm red mushroom head for a trigger action, maintained push button, with release by key no. 421E becomes: ZB4BS94412.  
 ■ Trigger action mushroom heads are tamper proof in that a change of contact state is not possible by teasing or floating the operator.



**ZBY9330**

**Circular Legends for Emergency Stop Mushroom Heads (yellow background)**

Diameter	Text	Catalog Number	Price
60 mm	Blank	ZBY9101	\$1.70
	EMERGENCY STOP	ZBY9330	
90 mm	Blank	ZBY8101	
	EMERGENCY STOP	ZBY8330	

For additional information, reference Catalog #9001CT0001.



**ZB4BD4**  
Standard Lever



**ZB4BJ3**  
Extended Lever

**Non-Illuminated Selector Switches ■◆**

Color▲	Number and Type of Positions				Price
			Standard Lever	Extended Lever	
Catalog Number					
Black	2-maintained		ZB4BD2	ZB4BJ2	\$12.00
Black	2-momentary from right to left		ZB4BD4	ZB4BJ4	14.70
Black	3-maintained		ZB4BD3	ZB4BJ3	12.00
Black	3-momentary to center		ZB4BD5	ZB4BJ5	14.70
Black	3-momentary from left to center		ZB4BD7	ZB4BJ7	14.70
Black	3-momentary from right to center		ZB4BD8	ZB4BJ8	14.70

▲ For colored lever, add the following code to the end of part number: 01—white, 03—green, 04—red, 05—yellow, 06—blue (Example: ZB4BD204).

**Non-Illuminated Key Switches■**



**ZB4BG8**



Shape of Head	Type of Operator	Number and Type of Positions		Catalog Number	Price	
	Key (No. 455)★	2-maintained		ZB4BG2	\$44.80	
				ZB4BG4		
		2-momentary from right to left		ZB4BG6		
			3-maintained			ZB4BG0
				ZB4BG3		
				ZB4BG03		
				ZB4BG5		
				ZB4BG9		
				ZB4BG09		
				ZB4BG09		
		3-momentary from left to center		ZB4BG1		58.00
		3-momentary to center		ZB4BG7		
		3-momentary from right to center		ZB4BG8		
				ZB4BG08		

The symbol indicates key withdrawal position(s).

■ For actuation of outside contacts only. Center position not used.

◆ See selector switch sequence charts below.

★ Other key numbers:

- key no. 421E: add the suffix 12 to the catalog number.
- key no. 458A: add the suffix 10 to the catalog number.
- key no. 520E: add the suffix 14 to the catalog number.
- key no. 3131A: add the suffix 20 to the catalog number.

Example: The catalog number for a head with key No. 421E for a 2 position maintained, lockable selector switch, with key withdrawal from the left-hand position, becomes: ZB4BG212.

**Selector Switch Sequence (using contact block assemblies, page 17-27; or complete bodies, page 17-27.)**

2 Position Selector Switch		
		Contact block guide ▼
O	X	1 N.O. (left or right)
X	O	1 N.C. (left or right)
O	X	1 N.O. and 1 N.C.
X	O	

3 Position Selector Switch			
			Contact block guide ▼
X	O	O	1 N.O. (left)
O	X	O	2 N.C. wired in <b>series</b> (side by side)
O	O	X	1 N.O. (right)
X	X	O	1 N.C. (right)
O	X	X	1 N.C. (left)
X	O	X	2 N.O. wired in <b>parallel</b> (side by side)

▼ As viewed from the front of the panel.

For additional information, reference Catalog #9001CT0001.

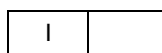

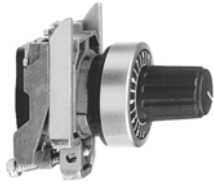

**ZB4BD922**

**Potentiometer Operator (with Mounting Collar)**

Shape of Head	Description	Application	Catalog Number	Price
	For potentiometer with shaft length 1.73 to 1.97 in. (44 to 50 mm) (potentiometer not included)	For shaft Ø 0.25 in. (6.35 mm)	ZB4BD922	\$71.00
		For shaft Ø 0.24 in. (6 mm)	ZB4BD912	

**Joystick Controllers (54 mm, Extended Operating Shaft) ▲**

Description	Contact Operation	Action	Catalog Number	Price
2 direction 	1 step 1 N.O. contact per direction	Maintained	XD4PA12	\$125.00
		Momentary	XD4PA22	
4 direction 	1 step 1 N.O. contact per direction	Maintained	XD4PA14	158.00
		Momentary	XD4PA24	

▲ It is not permissible to use standard contact blocks ZBE10• (single) or ZBE20• (double).

**Legends for Joystick Controllers**

Description	For use with	Color	Catalog Number	Price
Legends 30 x 48 mm for customer engraving	2 direction	Black one side Red reverse	ZBG2201	\$1.70
		White one side Yellow reverse	ZBG2401	
Legends 48 x 48 mm for customer engraving	4 direction	Black one side Red reverse	ZBG4201	
		White one side Yellow reverse	ZBG4401	



**XD4PA12**



**ZB4BD28**

**Two Position Toggle Switch**

Shape of Head	Color	Type of Positions	Catalog Number	Price
	Black	Maintained	ZB4BD28	\$23.30
	Black	Momentary	ZB4BD48	

**Reset Operators, Flush, Adjustable Shaft**

Shape of Head	Travel		Actuation Distance		Color	Catalog Number	Price	
	IN	mm	IN	mm				
	0.39	10	0.24–0.63	6–16	Black	XB4BA821	\$13.70	
					Red	XB4BA841		
					Blue	XB4BA861		
			0.63–1.02	16–26	Black	XB4BA822		13.70
					Red	XB4BA842		
					Blue	XB4BA862		
	0.55	14	1.18–5.12	30–130	Black	XB4BA921	16.40	
					Red	XB4BA941		
					Blue	XB4BA961		
			5.12–10.12	130–257	Black	XB4BA922		20.50
					Red	XB4BA942		
					Blue	XB4BA962		



**XB4BA8\*1**

For additional information, reference Catalog #9001CT0001.



ZB4BV063



ZB4BV04

**Pilot Light Heads**



Shape of Head	For Use with Body Comprising Light Module Type	Color of Lens	Catalog Number	Price
	PROTECTED LED® only	White Green Red Yellow Blue	ZB4BV013 ZB4BV033 ZB4BV043 ZB4BV053 ZB4BV063	<b>\$3.80</b>
	PROTECTED LED only Fresnel (jeweled) lens	White Green Red Amber Blue	ZB4BV013S ZB4BV033S ZB4BV043S ZB4BV053S ZB4BV063S	<b>3.80</b>
	For BA9s incandescent bulb, neon or LED only	White Green Red Yellow Blue Clear	ZB4BV01 ZB4BV03 ZB4BV04 ZB4BV05 ZB4BV06 ZB4BV07	<b>3.80</b>
	For BA9s incandescent bulb, neon or LED Fresnel (jeweled) lens	White Green Red Amber Blue Clear	ZB4BV01S ZB4BV03S ZB4BV04S ZB4BV05S ZB4BV06S ZB4BV07S	<b>3.80</b>

**Complete Bodies (Mounting Collar + Light Module for BA9s Incandescent Bulb, Neon or LED)**

Description	Light Source	Supply Voltage (V)	Catalog Number	Price
<b>Screw clamp terminal connections</b>				
Direct supply	BA9s bulb 2.4 W max. Not included ▲	≤ 250	ZB4BV6	<b>\$19.30</b>
Direct supply	BA9s incandescent bulb included	24 v 2 Watt	ZB4BV624	<b>24.60</b>
Direct supply	BA9s incandescent bulb included	120 v 2.4 Watt	ZB4BV6120	<b>24.60</b>
Transformer type 1.2 VA, 6 V secondary	BA9s incandescent bulb included	110–120 Vac 50/60 Hz	ZB4BV3	<b>49.20</b>
		230–240 Vac 50/60 Hz	ZB4BV4	
		400–50 Hz	ZB4BV5	
		440–480 Vac 60 Hz	ZB4BV8	
		550–600 Vac 60 Hz	ZB4BV9	

▲ Order bulb separately, see page 17-32.

**Complete Bodies (Mounting Collar + Light Module with PROTECTED LED)**







Light Source	Supply Voltage	Color of Light Source	Catalog Number	Price
<b>Screw clamp terminal connections■</b>				
	12 Vac/dc	White Green Red Yellow Blue	ZB4BVJ1 ZB4BVJ3 ZB4BVJ4 ZB4BVJ5 ZB4BVJ6	<b>\$28.60</b>
	24 Vac/dc	White Green Red Yellow Blue	ZB4VB1 ZB4VB3 ZB4VB4 ZB4VB5 ZB4VB6	<b>28.60</b>
	24–120 Vac/dc	White Green Red Yellow Blue	ZB4VBG1 ZB4VBG3 ZB4VBG4 ZB4VBG5 ZB4VBG6	<b>28.60</b>
	110–120 Vac	White Green Red Yellow Blue	ZB4VG1 ZB4VG3 ZB4VG4 ZB4VG5 ZB4VG6	<b>28.60</b>
	Flashing 24 Vac/dc	White Green Red Yellow Blue	ZB4BV18B1 ZB4BV18B3 ZB4BV18B4 ZB4BV18B5 ZB4BV18B6	<b>33.10</b>
	110–120 Vac	White Green Red Yellow Blue	ZB4BV18G1 ZB4BV18G3 ZB4BV18G4 ZB4BV18G5 ZB4BV18G6	<b>33.10</b>

■ For Quick-Connect version, add "3" to the end of the catalog number Example: ZB4BVJ13 (Quick-Connect size 1 x 0.250" or 2 x 0.110").



For additional information, reference Catalog #9001CT0001.



**Heads for Momentary Illuminated Push Buttons**

Shape of Head	Type of Push	Color	Catalog Number	Price
<b>Only use with PROTECTED LED® light modules</b>				
 ZB4BW333	Flush	White	ZB4BW313	<b>\$9.30</b>
		Green	ZB4BW333	
		Red	ZB4BW343	
		Yellow	ZB4BW353	
 ZB4BW563	Flush with clear boot	Blue	ZB4BW363	<b>15.50</b>
		White	ZB4BW513	
		Green	ZB4BW533	
		Red	ZB4BW543	
 ZB4BA18	Flush for insertion of legend	Yellow	ZB4BW553	<b>8.00</b>
		Blue	ZB4BW563	
		White	ZB4BA18	
		Green	ZB4BA38	
 ZB4BW113	Extended	Red	ZB4BA48	<b>6.50</b>
		Yellow	ZB4BA58	
		Blue	ZB4BA68	
		White	ZB4BW113	
 ZB4BW433	Mushroom (40 mm)	Green	ZB4BW133	<b>14.70</b>
		Red	ZB4BW143	
		Yellow	ZB4BW153	
		Blue	ZB4BW163	
		Clear	ZB4BW413	
 ZB4BW443	Flush	Green	ZB4BW433	<b>9.30</b>
		Red	ZB4BW443	
		Yellow	ZB4BW453	
		Blue	ZB4BW463	
 ZB4BW14	Extended	White	ZB4BW113	<b>6.50</b>
		Green	ZB4BW133	
		Red	ZB4BW143	
		Yellow	ZB4BW153	
		Blue	ZB4BW163	
		Clear	ZB4BW173	

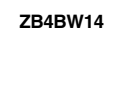

**Only use with light modules for a BA9s incandescent bulb, neon or LED**

 ZB4BW33	Flush	White	ZB4BW31	<b>9.30</b>
		Green	ZB4BW33	
		Red	ZB4BW34	
		Yellow	ZB4BW35	
		Blue	ZB4BW36	
 ZB4BW14	Extended	Clear	ZB4BW37	<b>6.50</b>
		White	ZB4BW11	
		Green	ZB4BW13	
		Red	ZB4BW14	
		Yellow	ZB4BW15	
 ZB4BW16	Flush	Blue	ZB4BW16	<b>9.30</b>
		Clear	ZB4BW17	
		White	ZB4BW18	

**Heads for Maintained Illuminated Push Buttons**

Shape of Head	Type of Push	Color of Lens	Catalog Number	Price
<b>Only use with PROTECTED LED light modules</b>				
 ZB4BW643	Push/Pull Mushroom (40 mm)	Clear	ZB4BW613	<b>\$23.00</b>
		Green	ZB4BW633	
		Red	ZB4BW643	
		Yellow	ZB4BW653	
 ZB4BW663	Flush	Blue	ZB4BW663	<b>9.30</b>
		White	ZB4BW673	

**Illuminated Push-on/Push-off Operators**

Shape of Head	Type of Push	Color of Lens	Catalog Number	Price
<b>Only use with PROTECTED LED light modules</b>				
 ZB4BH033	Flush	White	ZB4BH013	<b>\$12.40</b>
		Green	ZB4BH033	
		Red	ZB4BH043	
		Yellow	ZB4BH053	
 ZB4BH63	Extended	Blue	ZB4BH063	<b>9.80</b>
		White	ZB4BH13	
		Green	ZB4BH33	
		Red	ZB4BH43	
 ZB4BH53	Flush	Yellow	ZB4BH53	<b>9.80</b>
		Blue	ZB4BH63	

For additional information, reference Catalog #9001CT0001.



**ZB4BW812743**







**ZB4BW823743**









**ZB4BW841723**

**Two Button with Clear Pilot Light, Momentary (IP40) ▲**

Shape of Head	Description	Color of Pushers	Catalog Number	Price
<b>Only use with PROTECTED LED® light modules (PROTECTED LED determines pilot light color)</b>				
	1 flush 1 central pilot light 1 flush	Black Red	ZB4BW812743	<b>\$14.50</b>
		Green Red	ZB4BW813743	
		White Black	ZB4BW811723	
	1 flush 1 central pilot light 1 extended	Black Red	ZB4BW832743	<b>14.50</b>
		Green Red	ZB4BW833743	
		White Black	ZB4BW831723	
<b>Only use with PROTECTED LED light modules (PROTECTED LED determines pilot light color)—premarked</b>				
	1 flush (marked "I") 1 central pilot light 1 flush (marked "O")	Black Red	ZB4BW822743	<b>16.60</b>
		Green Red	ZB4BW823743	
		White Black	ZB4BW821723	
	1 flush (marked "I") 1 central pilot light 1 extended (marked "O")	Black Red	ZB4BW842743	<b>16.60</b>
		Green Red	ZB4BW843743	
		White Black	ZB4BW841723	



▲ For IP66 degree of protection, install clear sealing boot ZBW008, see page 17-33.



**Illuminated Selector Switches, Standard Lever**

Shape of Head	Number and Type of Positions		Catalog Number ■	Price
<b>Only use with PROTECTED LED light modules</b>				
	2-maintained		ZB4BK12*3	<b>\$17.50</b>
	2-momentary from right to left		ZB4BK14*3	<b>25.70</b>
	3-maintained		ZB4BK13*3	<b>17.50</b>
	3-momentary to center		ZB4BK15*3	<b>25.70</b>
	3-momentary from right to center		ZB4BK18*3	<b>25.70</b>
	3-momentary from left to center		ZB4BK17*3	<b>25.70</b>

■ Designate color as follows: 1—white, 3—green, 4—red, 5—yellow, 6—blue.

**Selector Switch Sequence (using contact block assemblies, page 17-27; or complete bodies, page 17-27.)**

2 Position Selector Switch		
		Contact block guide ♦
O	X	1 N.O. (left or right)
X	O	1 N.C. (left or right)
O	X	1 N.O. and 1 N.C.
X	O	

3 Position Selector Switch			
			Contact block guide ♦
X	O	O	1 N.O. (left)
O	X	O	2 N.C. wired in <b>series</b> (side by side)
O	O	X	1 N.O. (right)
X	X	O	1 N.C. (right)
O	X	X	1 N.C. (left)
X	O	X	2 N.O. wired in <b>parallel</b> (side by side)

♦ As viewed from the front of the panel.

For additional information, reference Catalog #9001CT0001.

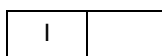

**Contact Blocks (Mounting Collar with Contact Blocks)**



**ZB4BZ101**

Description	Type of Contact		Catalog Number	Price
	N.O.	N.C.		
Screw clamp terminal connections	1	...	ZB4BZ101	\$11.00
	...	1	ZB4BZ102	11.00
	2	...	ZB4BZ103	19.10
	...	2	ZB4BZ104	19.10
	1	1	ZB4BZ105	19.10
	1	2	ZB4BZ141	27.30

- ▲ For Quick-Connect version add "3" to the end of the catalog number Example: ZB4BZ1013 (Quick-Connect size 1 x 0.250" or 2 x 0.110").
- For Ring Tongue compatible blocks add "9" to the end of the catalog number (Example: ZB4BZ1029).
- ◆ Electrical components with connection by printed circuit board pins are available. Consult local field office for details.
- ★ Electrical components with connection by plug-in connector are available. Consult local field office for details.

**Complete Bodies (Mounting Collar + Single Contact Block + Light Module with PROTECTED LED®)**

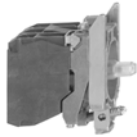

**ZB4BW0\*3**

Light Source	Type of Contact ▼		Color	Supply Voltage		Price
	N.O.	N.C.		24 Vac/dc	110–120 Vac	
				Catalog Number		

**Screw clamp terminal connections**

<b>Protected LED</b>	1	...	White	ZB4BW0B11	ZB4BW0G11	\$36.70
			Green	ZB4BW0B31	ZB4BW0G31	
			Red	ZB4BW0B41	ZB4BW0G41	
			Yellow	ZB4BW0B51	ZB4BW0G51	
	...	1	White	ZB4BW0B12	ZB4BW0G12	36.70
			Green	ZB4BW0B32	ZB4BW0G32	
			Red	ZB4BW0B42	ZB4BW0G42	
			Yellow	ZB4BW0B52	ZB4BW0G52	
	2	...	White	ZB4BW0B13	ZB4BW0G13	44.90
			Green	ZB4BW0B33	ZB4BW0G33	
			Red	ZB4BW0B43	ZB4BW0G43	
			Yellow	ZB4BW0B53	ZB4BW0G53	
1	1	White	ZB4BW0B15	ZB4BW0G15	44.90	
		Green	ZB4BW0B35	ZB4BW0G35		
		Red	ZB4BW0B45	ZB4BW0G45		
		Yellow	ZB4BW0B55	ZB4BW0G55		
			Blue	ZB4BW0B65	ZB4BW0G65	

▼ Can be fitted with additional contact blocks, see page 17-28.

**Mounting Collar, Contact Block and Light Module (with screw clamp terminal connections) Δ**



**ZB4B06\***



**ZB4BW0\*5**

Supply	Light Source	Supply Voltage	Type of Contact Δ		Color of Light Source	Catalog Number	Price
			N.O.	N.C.			

**Screw clamp terminal connections**

Direct supply	BA9s 2.4 W max. bulb Not included □	≤ 250 Vac/dc	1	...	...	ZB4BW061	\$27.40
			...	1	...	ZB4BW062	27.40
			2	...	...	ZB4BW063	35.60
			1	1	...	ZB4BW065	35.60
			1	...	...	ZB4BW031	57.00
Transformer type 1.2 VA, 6 V secondary	BA9s incandescent bulb included	110–120 Vac 50/60 Hz	1	1	...	ZB4BW035	65.00
			1	...	...	ZB4BW041	57.00
		230–240 Vac 50/60 Hz	1	1	...	ZB4BW045	65.00
			1	...	...	ZB4BW081	57.00
		440–480 Vac 60 Hz	1	1	...	ZB4BW085	65.00

Δ Can be fitted with additional contact blocks, see page 17-28.  
□ Order bulb separately, see page 17-32.

For additional information, reference Catalog #9001CT0001.



ZB4BZ009

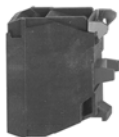

ZBE101



ZBE203



ZBVB\*

**Body/Mounting Collar**

For use with	Catalog Number	Price
Electrical block (contact or light module)	ZB4BZ009	\$2.70

**Add-On Contact Block (with screw clamp terminal connections) ★▼**

Description	Type of Contact		Catalog Number	Price
	N.O.	N.C.		
Standard single contact blocks▲■	1	...	ZBE101	\$8.20
	...	1	ZBE102	8.20
Standard double contact blocks▲■	2	...	ZBE203	16.60
	...	2	ZBE204	16.60
	1	1	ZBE205	16.60
Special contact blocks (for low power switching and dust protected)◆	1	...	ZBE1016	16.40
	...	1	ZBE1026	16.40

▲ For Quick-Connect version add "3" to the end of the catalog number Example: ZBE1013 (Quick-Connect size 1 x 0.250" or 2 x 0.110").  
 ■ For Ring Tongue compatible blocks add "9" to the end of the catalog number (Example: ZBE1029).  
 ◆ Cannot stack additional contact blocks onto these blocks.

**Light Modules (with screw clamp terminal connections) ★▼**

Description	Supply Voltage	Color of Light Source	Catalog Number	Price
	12 Vac/dc	White	ZBVJ1	\$25.90
		Green	ZBVJ3	
		Red	ZBVJ4	
		Yellow	ZBVJ5	
		Blue	ZBVJ6	
	24 Vac/dc	White	ZBVB1	25.90
		Green	ZBVB3	
		Red	ZBVB4	
		Yellow	ZBVB5	
		Blue	ZBVB6	
	110–120 Vac	White	ZBVG1	25.90
		Green	ZBVG3	
		Red	ZBVG4	
		Yellow	ZBVG5	
		Blue	ZBVG6	
	24–120 Vac/dc	White	ZBVBG1	25.90
		Green	ZBVBG3	
		Red	ZBVBG4	
		Yellow	ZBVBG5	
		Blue	ZBVBG6	
	230–240 Vac	White	ZBVM1	25.90
		Green	ZBVM3	
		Red	ZBVM4	
		Yellow	ZBVM5	
		Blue	ZBVM6	
Direct supply for BA9s 2.4 W max. bulb Not included	≤ 250 Vac/dc	...	ZBV6	16.60
Super Bright <b>Protected LED</b>	12 Vac/dc	White	ZBVJ1S	33.60
		Green	ZBVJ3S	
		Red	ZBVJ4S	
		Yellow	ZBVJ5S	
		Blue	ZBVJ6S	
	24 Vac/dc	White	ZBVB1S	33.60
		Green	ZBVB3S	
		Red	ZBVB4S	
		Yellow	ZBVB5S	
		Blue	ZBVB6S	
	48–120 Vac	White	ZBVG1S	33.60
		Green	ZBVG3S	
		Red	ZBVG4S	
		Yellow	ZBVG5S	
		Blue	ZBVG6S	

★ Electrical components with connection by printed circuit board pins are available. Consult local field office for details.  
 ▼ Electrical components with connection by plug-in connector are available. Consult local field office for details.

For additional information, reference Catalog #9001CT0001.

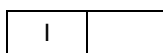

**Standard (30 x 40 mm) Legend Plates for 8 x 27 mm Legends▲**

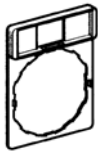

**ZBZ32**



**ZBY•101**



**ZBY2303**

Description	Legend		Catalog Number	Price
	Color	Text		
Without legend	...	...	ZBZ32	\$1.00
With blank legend (for engraving)	Black or red background	...	ZBY2101	1.70
	White or yellow background	...	ZBY4101	
Custom Legend (Specify Engraving) 2 lines of 11 characters (including spaces) maximum per line	Black background	White	ZBY2002	7.10
	Red background	White	ZBY2004	
	White background	Black	ZBY4001	
	Yellow background	Black	ZBY4005	
With international language marked legend	Black or red background ■	O (black background)	ZBY2146	1.70
		O (red background)	ZBY2931	
		I	ZBY2147	
		II	ZBY2148	
		O-I	ZBY2178	
		I-II	ZBY2179	
		I-O-II	ZBY2186	
With English language marked legend	Black or red background ■	AUTO	ZBY2115	1.70
		AUTO-HAND	ZBY2364	
		AUTO-O-HAND	ZBY2385	
		CLOSE	ZBY2314	
		DOWN	ZBY2308	
		EMERGENCY STOP	ZBY2330	
		FAST	ZBY2328	
		FORWARD	ZBY2305	
		FOR-REV	ZBY2371	
		HAND	ZBY2316	
		HAND-OFF-AUTO	ZBY2387	
		INCH	ZBY2321	
		JOG	ZBY2382	
		LEFT	ZBY2310	
		OFF	ZBY2312	
		OFF-ON	ZBY2367	
		ON	ZBY2311	
		OPEN	ZBY2313	
		POWER ON	ZBY2326	
		RESET (red background)	ZBY2323	
		RESET (black background)	ZBY2322	
		REVERSE	ZBY2306	
		RIGHT	ZBY2309	
		RUN	ZBY2334	
		SLOW	ZBY2327	
		START	ZBY2303	
		STOP	ZBY2304	
		STOP-START	ZBY2366	
		UP	ZBY2307	

▲ For legends, see page 17-30.  
 ■ Start functions: white letters on black background. Stop functions: white letters on red background (unless otherwise specified above).

**Standard (30 x 50 mm) Legend Plates for 18 x 27 mm Legends**



**ZBZ33**



**ZBY610•**

Description	Color	Catalog Number	Price
Without legend insert	...	ZBZ33	\$1.00
With blank legend insert	Black or red background	ZBY6101	1.70
	White or yellow background	ZBY6102	

For additional information, reference Catalog #9001CT0001.

# Push Buttons—XB4 22 mm

## Legend Plates, Inserts Only

### Marked Legends for 8 x 27 mm (for 30 x 40 mm legend holders ZBZ32)

Color	Marking	Text	Catalog Number	Price
Black or red background▲	International	O (black background) O (red background) I II O-I I-II I-O-II	ZBY02146 ZBY02931 ZBY02147 ZBY02148 ZBY02178 ZBY02179 ZBY02186	\$0.83
	English	AUTO AUTO-HAND AUTO-O-HAND CLOSE DOWN EMERGENCY STOP FAST FORWARD FOR-REV HAND HAND-OFF-AUTO INCH JOG LEFT OFF OFF-ON ON OPEN POWER ON RESET (red background) RESET (black background) REVERSE RIGHT RUN SLOW START STOP STOP-START UP	ZBY02115 ZBY02364 ZBY02385 ZBY02314 ZBY02308 ZBY02330 ZBY02328 ZBY02305 ZBY02371 ZBY02316 ZBY02387 ZBY02321 ZBY02382 ZBY02310 ZBY02312 ZBY02367 ZBY02311 ZBY02313 ZBY02326 ZBY02323 ZBY02322 ZBY02306 ZBY02309 ZBY02334 ZBY02327 ZBY02303 ZBY02304 ZBY02366 ZBY02307	0.83

▲ Start functions: white letters on black background. Stop functions: white letters on red background (unless otherwise specified above).

### Legends for Customer Engraving (inserts only)

Description	For use with	Color	Catalog Number	Price
8 x 27 mm	30 x 40 mm legend holders	Black or red background	ZBY0101	\$0.83
		White or yellow background	ZBY0102	
18 x 27 mm	30 x 50 mm legend holders	Black or red background	ZBY5101	
		White or yellow background	ZBY5102	

### Legends for Factory Engraving (inserts only)

Description	For use with	Color	Text	Catalog Number	Price
8 x 27 mm Custom Legend/Insert Only (Specify Engraving) 2 lines of 11 characters (including spaces) maximum per line	30 x 40 mm legend holders	Black background	White	ZBY01002	\$6.10
		Red background	White	ZBY01004	
		White background	Black	ZBY01001	
		Yellow background	Black	ZBY01005	
18 x 27 mm Custom Legend/Insert Only (Specify Engraving) 3 lines of 11 characters (including spaces) maximum per line	30 x 50 mm legend holders	Black background	White	ZBY05002	6.10
		Red background	White	ZBY05004	
		White background	Black	ZBY05001	
		Yellow background	Black	ZBY05005	

For additional information, reference Catalog #9001CT0001.



**Sheets of Legends for Push Buttons, Switches, and Pilot Lights**

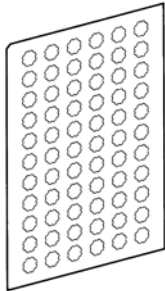

ZBY1101

Description	Marking	Text	Catalog Number	Price	
Sheets of 66 circular peel-off transparent self-adhesive legends	Blank		ZBY1101	\$3.10	
	International	O		ZBY1146	5.20
		I		ZBY1147	
		II		ZBY1148	
		III		ZBY1149	
		STOP		ZBY1304	
		→		ZBY1912	
	English	HAND		ZBY1316	5.20
		OFF		ZBY1312	
		ON		ZBY1311	
		START		ZBY1303	
	SiS Label Software	Legend Design Software: English, French, German, Spanish, Italian		XYB2U	52.00

**Push Button Caps—Unmarked**



ZBA•



ZBL•

For use with	Type of Push	Color	Catalog Number	Price
ZB4BA0 push button heads supplied with cap	Flush	White	ZBA1	\$1.00
		Black	ZBA2	
		Green	ZBA3	
		Red	ZBA4	
		Yellow	ZBA5	
		Blue	ZBA6	
	Extended	6 colors ■	ZBA9	2.10
		White	ZBL1	1.00
		Black	ZBL2	
		Green	ZBL3	
		Red	ZBL4	
		Yellow	ZBL5	
		Blue	ZBL6	
		6 colors ■	ZBL9	2.10

**Push Button Caps—Marked**



ZBA•33

For use with	Type of Push	Marking		Color of Cap	Catalog Number	Price
		Text	Color			
ZB4BA0 push button heads supplied with cap	Flush	I ♦	White	Green	ZBA331	\$2.10
			Black	White	ZBA131	
		START ♦	White	Green	ZBA333	
			Black	White	ZBA133	
		ON	White	Green	ZBA341	
			Black	White	ZBA141	
		UP ♦	Black	White	ZBA343	
		DOWN ♦	White	Black	ZBA344	
		⊕ ♦	White	Green	ZBA345	
		⊖ ♦	White	Black	ZBA245	
		◊	White	Green	ZBA346	
		↑	Black	White	ZBA334★	
			White	Black	ZBA335★	
		O ♦	White	Red	ZBA432	
				Black	ZBA232	
		STOP ♦	White	Red	ZBA434	
				Black	ZBA234	
		OFF	White	Red	ZBA435	
				Black	ZBA235	
		R ♦	White	Blue	ZBA639	

▲ Start functions: white letters on black background. Stop functions: white letters on red background (unless otherwise specified above).  
 ■ Set of 6 different colored caps: white, black, green, red, yellow, blue.  
 ♦ Double injection molded marking.  
 ★ Cap supplied not clipped-in, allowing orientation of arrow in 4 directions: ↑, ↓, ← or →

For additional information, reference Catalog #9001CT0001.

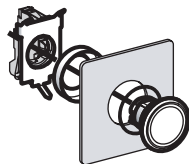
**ZBZ160**
**ZB4BZ6**

**ZB4BZ011**

**ZB4SZ3**

**ZB5SZ3**

**DL1CE**

**DL1CF**

**XBFX13**

**ZBZ8**

**ZBG455**

### Accessories

Description	Application	Color	Catalog Number	Price
Metal guards Padlockable	For Emergency Stop function only with the following Ø 40 mm trigger-action push buttons: XB4BT8 XB4BS8 XB4BS9 ZB4BT8 ZB4BS8 ZB4BS9	Chromium Plated	ZBZ1600	\$54.00
		Black	ZBZ1602	
		Red	ZBZ1604	
		Yellow	ZBZ1605	
		Blue	ZBZ1606	
Plastic guards ■	Round Guard for 40 mm EMO Mushroom Operators	Yellow	ZB4BZ1905	12.90
	Narrow Flange Guard for 40 mm EMO Mushroom Operators	Yellow	ZB4BZ2005	
Padlockable flaps	For push buttons	Black	ZB4BZ62	16.40
		Red	ZB4BZ64	
Mounting kit	For push buttons ZB4B with flush mounting bezel head Minimum quantity 10		ZB4BZ011	8.30
Metal blanking plug, round chromium plated ▲	For Ø 22 mm control and signalling units		ZB4SZ3	5.50
Plastic blanking plug, round black with mounting nut	For Ø 22 mm control and signalling units		ZB5SZ3	5.50

▲ Requires a ZB4BZ009 body/mounting collar for mounting, see page 17-28.

■ For additional information, reference publication 0106HO9802R8/03.

### BA9s Bulbs and Associated Accessories

Description	Characteristics	Catalog Number	Price
Replacement bulbs (Type BA9s) Incandescent	6 V, 1.2 W	DL1CB006	\$5.50
	12 V, 2 W	DL1CE012	
	24 V, 2 W	DL1CE024	
	120–130 V, 2.4 W	DL1CE130	
Neon bulbs	120–130 V	DL1CF110	7.60
	230–240 V	DL1CF220	
Bulb extractor		XBFX13	5.50
Lens cap tightening tool	Illuminated push buttons with flush push	ZBZ8	3.10
Power driver bits for mounting and wiring (package of 5)	Cross headed screw (POZIDRIV type 1)	ZB4BZ905	25.90
Mounting Adapter	For mounting 22 mm push button in 30 mm KO	ZBZ41	5.20

### Replacement Keys for Emergency Stop Push Buttons and Selector Switches

Description	Key Number	Catalog Number	Price
Set of 2 keys	455	ZBG455	\$5.50
	421E	ZBG421E	
	458A	ZBG458A	
	520E	ZBG520E	
	3131A	ZBG3131A	

For additional information, reference Catalog #9001CT0001.





**ZBP0**

**Clear Boots**

Description	For use with	Catalog Number	Price
Single boots	Booted push buttons with circular head	ZBP0	\$6.20
	Booted push buttons with circular head used in food industry applications	ZBP0A	6.20
Double boots	Double-headed push buttons, with or without pilot light	ZBW008	16.40
	Double-headed push buttons used in food industry applications	ZBW008A	16.40

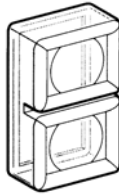

**ZBW008**

**Lens Caps**

For use with	Color	Catalog Number	Price
--------------	-------	----------------	-------

**Lens caps for PROTECTED LED® light modules**

Pilot lights	White	ZBV0113	2.70
	Green	ZBV0133	
	Red	ZBV0143	
	Yellow	ZBV0153	
	Blue	ZBV0163	
Illuminated push buttons with flush push	White	ZBW9113	2.70
	Green	ZBW9133	
	Red	ZBW9143	
	Yellow	ZBW9153	
Illuminated push buttons with extended push	Blue	ZBW9163	2.70
	White	ZBW9313	
	Green	ZBW9333	
	Red	ZBW9343	
	Yellow	ZBW9353	
	Blue	ZBW9363	



**ZBV01•3**

**Lens caps for BA9 light modules**

Pilot lights	White	ZBV011	2.70
	Green	ZBV013	
	Red	ZBV014	
	Yellow	ZBV015	
	Blue	ZBV016	
Illuminated push buttons with flush push	Clear	ZBV017	2.70
	White	ZBW911	
	Green	ZBW913	
	Red	ZBW914	
	Yellow	ZBW915	
Illuminated push buttons with extended push	Blue	ZBW916	2.70
	Clear	ZBW917	
	White	ZBW931	
	Green	ZBW933	
	Red	ZBW934	
	Yellow	ZBW935	
	Blue	ZBW936	
	Clear	ZBW937	



**ZBV01•**

For additional information, reference Catalog #9001CT0001.

# Push Buttons—XB5 22 mm

## Characteristics



www.SquareD.com

For the most up-to-date information

17 PUSH BUTTONS AND OPERATOR INTERFACE

### Environment

Degree of protection	Conforming to IEC 529	IP65, unless otherwise stated IP66, for booted push button heads
	Conforming to UL 50 and CSA C22.2 No. 94	Type 1, 2, 3, 4, 4X, 12, and 13, unless otherwise stated
Conforming to standards	Marked	IEC 947-1, IEC/EN 60947-5-1, IEC 947-5-4, EN 60947-1, JIS C 4520, UL 508, CSA C22.2 No. 14
Product certifications	UL Listed, CSA	Standard single contacts with screw clamp terminals: A600; Q600 Double contacts with screw clamp terminals: A600; Q600 Light modules with screw clamp terminals JOYSTICK XD4-PA: A600; R300
	File E164353 CCN NKCR  File LR 44087 Class 3211 03  File E164353 CCN NKCR 2	BV, RINA, LROS, DNV, GL (pending)

### Electrical Characteristics of Operators and Contact Blocks

Cabling capacity	Conforming to IEC 947-1	Screw and captive clamp terminals Min: 1 x 24 AWG (0.22 mm <sup>2</sup> ) without cable end 1 x 22 AWG (0.34 mm <sup>2</sup> ) for linking Max: 2 x 16 AWG (1.5 mm <sup>2</sup> ) with cable end 2 x 14 AWG (2.5 mm <sup>2</sup> ) without cable ends Cross headed screw (POZIDRIV type 1) slotted for flat 4 and 5.5 mm screwdriver		
Maximum Contact Block Usage	XB5/ZB5 Maximum Number of Blocks	Push buttons (Non-Illuminated)	9	
		Selector switches (Non-Illuminated)	6	
		Push buttons and selectors (Illuminated)	6	
		Mushrooms, Push Pull (Non-Illuminated)	6	
		Mushrooms, Push Pull (Illuminated)	4	
		Mushrooms, Turn-to-Release (Non-Illuminated)	6	
		Mushrooms, Trigger Action (Non-Illuminated)	4	
		Push-on/Push-off (Non-Illuminated)	3	
Rated operational characteristics Conforming to IEC/EN 60947-5-1	AC supply: Utilization category AC-15	Standard blocks (single or double) with screw clamp terminals: A600: Ue = 600 Vac and Ie = 1.2 A or Ue = 240 Vac and Ie = 3 A or Ue = 120 Vac and Ie = 6 A Continuous Thermal Current 10 A		
	DC supply: Utilization category DC-13	Standard single or double blocks with screw clamp terminals: Q600: Ue = 600 Vdc and Ie = 0.1 A or Ue = 250 Vdc and Ie = 0.27 A or Ue = 125 Vdc and Ie = 0.55 A Joystick XD4PA: R300: Ue = 125 Vdc and Ie = 0.22 A or Ue = 250 Vdc and Ie = 0.1 A		
Electrical durability Conforming to IEC/EN 60947-5-1 Appendix C Operating rate 3600 operating cycles/hour. Load factor: 0.5	AC supply for 1 million operating cycles, utilization category AC-15	Standard blocks for screw clamp terminals:		
		24 Vac	120 Vac	230 Vac
		4 A	3 A	2 A
		Standard double blocks with screw clamp terminals:		
	24 Vac	120 Vac	230 Vac	
	3 A	1.5 A	1 A	
	DC supply for 1 million operating cycles, utilization category DC-13	Standard single blocks for screw clamp terminals:		
		24 Vdc	110 Vdc	
0.5 A		0.2 A		
Standard double blocks with screw clamp terminals:				
24 Vdc	110 Vdc			
0.4 A	0.15 A			

### Electrical Characteristics of Light Modules

Cabling capacity	Conforming to IEC 947-1	Screw and captive clamp terminals Min: 1 x 24 AWG (0.22 mm <sup>2</sup> ) without cable end 1 x 22 AWG (0.34 mm <sup>2</sup> ) for linking Max: 2 x 16 AWG (1.5 mm <sup>2</sup> ) with cable end
------------------	-------------------------	---

### Specific Characteristics of PROTECTED LED® Light Modules Only

Voltage limits	Nominal voltage	24 V: 19.2 to 30 Vdc, 21.6 to 26.4 Vac; 120 V: 102 to 132 Vac; 240 V: 195 to 264 Vac
Current consumption	Applicable to all colors	24 Vac/dc supply blocks: 18 mA 120 Vac supply blocks: 14 mA 240 Vac supply blocks: 14 mA

### Specific Characteristics of Hour Counters and Annunciators

Voltage limits	Hour counter and annunciator	± 10% of nominal voltage
Current consumption	Hour counter	XB5DSB: 7 to 15 mA
		XB5DSG: 8 mA XB5DSM: 8 mA
	Annunciator	5 mA

For additional information, reference Catalog #9001CT0001.

**Non-Illuminated Push Buttons, Momentary (screw clamp terminal connections)**



**XB5AA31**



**XB5AA4322**



**XB5AP51**



**XB5AL42**



**XB5AC21**

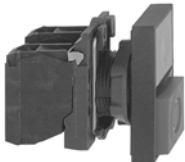

**XB5AL845**

Shape of Head	Type of Push	Type of Contact		Marking	Color of Cap	Catalog Number (Components)	Price
		N.O.	N.C.				
	Flush	1	...	...	Black	XB5AA21 (ZB5AZ101 + ZB5AA2)	\$17.50
					Green	XB5AA31 (ZB5AZ101 + ZB5AA3)	
					Yellow	XB5AA51 (ZB5AZ101 + ZB5AA5)	
					Blue	XB5AA61 (ZB5AZ101 + ZB5AA6)	
		...	1	...	Red	XB5AA42 (ZB5AZ102 + ZB5AA4)	17.50
		1	1	...	Black	XB5AA25 (ZB5AZ105 + ZB5AA2)	25.60
					Green	XB5AA35 (ZB5AZ105 + ZB5AA3)	
					Red	XB5AA45 (ZB5AZ105 + ZB5AA4)	
Yellow	XB5AA55 (ZB5AZ105 + ZB5AA5)						
Blue	XB5AA65 (ZB5AZ105 + ZB5AA6)						
	Flush	1	...	"I" (white)	Green	XB5AA3311 (ZB5AZ101 + ZB5AA331)	20.30
	Flush	...	1	"O" (white)	Red	XB5AA4322 (ZB5AZ102 + ZB5AA432)	20.30
	Flush with clear silicone boot (color of pusher unobscured)	1	...	...	Black	XB5AP21 (ZB5AZ101 + ZB5AP2)	23.90
					Green	XB5AP31 (ZB5AZ101 + ZB5AP3)	
					Yellow	XB5AP51 (ZB5AZ101 + ZB5AP5)	
					Blue	XB5AP61 (ZB5AZ101 + ZB5AP6)	
...	1	...	Red	XB5AP42 (ZB5AZ102 + ZB5AP4)	23.90		
...	1	...	Red	XB5AL42 (ZB5AZ102 + ZB5AL4)	17.50		
	Extended	1	1	...	Red	XB5AL45 (ZB5AZ105 + ZB5AL4)	25.60
	Mushroom head Ø 40 mm	1	...	...	Black	XB5AC21 (ZB5AZ101 + ZB5AC2)	25.70

**Two Button Push Buttons, Momentary (screw clamp terminal connections)**

Shape of Head	Type of Push	Type of Contact		Degree of Protection	Catalog Number (Components)	Price
		N.O.	N.C.			
	One flush green push (marked "I") One extended red push (marked "O")	1	1	IP40	XB5AL845 (ZB5AZ105 + ZB5AL8434)	\$31.50

For additional information, reference Catalog #9001CT0001.

# Push Buttons—XB5 22 mm

Complete Devices



www.SquareD.com

For the most up-to-date information

## Non-Illuminated Emergency Stop Mushroom Head Push Buttons, Ø 40 mm (Red) (screw clamp terminal connections)

Shape of Head	Type of Push	Type of Contact		Catalog Number (Components)	Price
		N.O.	N.C.		
	Trigger action push-pull▲	1	1	XB5AT845 (ZB5AZ105 + ZB5AT84)	\$46.00
	Trigger action turn-to-release▲	1	1	XB5AS8445 (ZB5AZ105 + ZB5AS844)	75.00
	Trigger action Key release (No. 455)▲	1	1	XB5AS9445 (ZB5AZ105 + ZB5AS944)	75.00
	Push-pull	...	1	XB5AT42 (ZB5AZ102 + ZB5AT4)	31.20
	Turn-to-release	...	1	XB5AS542 (ZB5AZ102 + ZB5AS54)	50.00
	Key release (No. 455)	...	1	XB5AS142 (ZB5AZ102 + ZB5AS14)	67.00

▲ Trigger action mushroom heads are tamper proof in that a change of contact state is not possible by teasing or floating the operator.

## Non-Illuminated Selector Switches and Key Switches (screw clamp terminal connections)

Shape of Head	Type of Operator	Type of Contact		Number and Type of Positions	Catalog Number (Components)	Price	
		N.O.	N.C.				
	Standard lever, black	1	...	2-maintained		XB5AD21 (ZB5AZ101 + ZB5AD2)	\$23.00
		1	1	2-maintained		XB5AD25 (ZB5AZ105 + ZB5AD2)	31.10
		2	...	3-maintained		XB5AD33 (ZB5AZ103 + ZB5AD3)	31.10
				3-momentary to center		XB5AD53 (ZB5AZ103 + ZB5AD5)	33.80
	Extended lever, black	1	...	2-maintained		XB5AJ21 (ZB5AZ101 + ZB5AJ2)	23.00
		2	...	3-maintained		XB5AJ33 (ZB5AZ103 + ZB5AJ3)	31.10
				3-momentary to center		XB5AJ53 (ZB5AZ103 + ZB5AJ5)	33.80
			Key (No. 455)	1	...	2-maintained	
	XB5AG41 (ZB5AZ101 + ZB5AG4)					55.80	
2-momentary to left						XB5AG61 (ZB5AZ101 + ZB5AG6)	55.80
2	...			3-maintained		XB5AG03 (ZB5AZ103 + ZB5AG0)	63.90
					XB5AG33 (ZB5AZ103 + ZB5AG3)	63.90	

The symbol indicates key withdrawal position(s)

17 PUSH BUTTONS AND OPERATOR INTERFACE



XB5AS9445



XB5AT42



XB5AS542



XB5AD33



XB5AJ33



XB5AG33

For additional information, reference Catalog #9001CT0001.

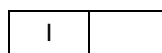

Discount  
Schedule



**XB5AVB1**



**XB5AV63**

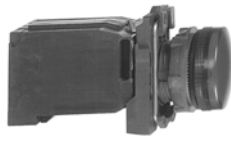

**XB5AV34**

**Pilot Lights with PROTECTED LED® (screw clamp terminal connections)**

Shape of Head	Supply Voltage	Color	Catalog Number (Components)	Price
	24 Vac/dc	White	XB5AVB1 (ZB5AVB1 + ZB5AV013)	<b>\$32.40</b>
		Green	XB5AVB3 (ZB5AVB3 + ZB5AV033)	
		Red	XB5AVB4 (ZB5AVB4 + ZB5AV043)	
		Yellow	XB5AVB5 (ZB5AVB5 + ZB5AV053)	
		Blue	XB5AVB6 (ZB5AVB6 + ZB5AV063)	
	110–120 Vac	White	XB5AVG1 (ZB5AVG1 + ZB5AV013)	<b>32.40</b>
		Green	XB5AVG3 (ZB5AVG3 + ZB5AV033)	
		Red	XB5AVG4 (ZB5AVG4 + ZB5AV043)	
		Yellow	XB5AVG5 (ZB5AVG5 + ZB5AV053)	
		Blue	XB5AVG6 (ZB5AVG6 + ZB5AV063)	

**Pilot Lights for BA9s Bulb (screw clamp terminal connections)**











Shape of Head	Supply Voltage	Color	Catalog Number (Components)	Price
<b>Direct supply, for BA9s (incandescent, LED, neon) V ≤ 250 V, 2.4 W bulb (bulb not included)</b>				
	≤ 250 Vac/dc	White	XB5AV61 (ZB5AV6 + ZB5AV01)	<b>\$23.10</b>
		Green	XB5AV63 (ZB5AV6 + ZB5AV03)	
		Red	XB5AV64 (ZB5AV6 + ZB5AV04)	
		Yellow	XB5AV65 (ZB5AV6 + ZB5AV05)	
<b>Transformer type with 1.2 VA, 6 V secondary. BA9s incandescent bulb included</b>				
	110–120 Vac 50/60 Hz	White	XB5AV31 (ZB5AV3 + ZB5AV01)	<b>53.00</b>
		Green	XB5AV33 (ZB5AV3 + ZB5AV03)	
		Red	XB5AV34 (ZB5AV3 + ZB5AV04)	
		Yellow	XB5AV35 (ZB5AV3 + ZB5AV05)	

**Illuminated Push Buttons, Momentary (screw clamp terminal connections)**

Shape of Head	Description	Type of Contact		Supply Voltage	Color of Push	Catalog Number (Components)	Price
		N.O.	N.C.				
<b>Flush</b>							
	Direct supply for BA9s 2.4 W max. bulb <b>not</b> included	1	1	24 Vac/dc	White	XB5AW31B5 (ZB5AW0B15 + ZB5AW313)	<b>\$54.00</b>
					Green	XB5AW33B5 (ZB5AW0B35 + ZB5AW333)	
					Red	XB5AW34B5 (ZB5AW0B45 + ZB5AW343)	
					Yellow	XB5AW35B5 (ZB5AW0B55 + ZB5AW353)	
					Blue	XB5AW36B5 (ZB5AW0B65 + ZB5AW363)	
				110–120 Vac	White	XB5AW31G5 (ZB5AW0G15 + ZB5AW313)	<b>54.00</b>
					Green	XB5AW33G5 (ZB5AW0G35 + ZB5AW333)	
					Red	XB5AW34G5 (ZB5AW0G45 + ZB5AW343)	
					Yellow	XB5AW35G5 (ZB5AW0G55 + ZB5AW353)	
					Blue	XB5AW36G5 (ZB5AW0G65 + ZB5AW363)	
	Direct supply for BA9s 2.4 W max. bulb <b>not</b> included	1	1	≤ 250 Vac/dc	White	XB5AW3165 (ZB5AW065 + ZB5AW31)	<b>44.90</b>
					Green	XB5AW3365 (ZB5AW065 + ZB5AW33)	
					Red	XB5AW3465 (ZB5AW065 + ZB5AW34)	
					Yellow	XB5AW3565 (ZB5AW065 + ZB5AW35)	
	Transformer type 1.2 VA, 6 V secondary. BA9s incandescent bulb included	1	1	110–120 Vac 50/60 Hz	White	XB5AW3135 (ZB5AW035 + ZB5AW31)	<b>74.00</b>
					Green	XB5AW3335 (ZB5AW035 + ZB5AW33)	
					Red	XB5AW3435 (ZB5AW035 + ZB5AW34)	
					Yellow	XB5AW3535 (ZB5AW035 + ZB5AW35)	
				230–240 Vac 50/60 Hz	White	XB5AW3145 (ZB5AW045 + ZB5AW31)	<b>74.00</b>
					Green	XB5AW3345 (ZB5AW045 + ZB5AW33)	
					Red	XB5AW3445 (ZB5AW045 + ZB5AW34)	
					Yellow	XB5AW3545 (ZB5AW045 + ZB5AW35)	
<b>Extended</b>							
	Direct supply for BA9s 2.4 W max. bulb <b>not</b> included	1	1	24 Vac/dc	White	XB5AW11B5 (ZB5AW0B15 + ZB5AW113)	<b>\$51.40</b>
					Green	XB5AW13B5 (ZB5AW0B35 + ZB5AW133)	
					Red	XB5AW14B5 (ZB5AW0B45 + ZB5AW143)	
					Yellow	XB5AW15B5 (ZB5AW0B55 + ZB5AW153)	
					Blue	XB5AW16B5 (ZB5AW0B65 + ZB5AW163)	
				110–120 Vac	White	XB5AW11G5 (ZB5AW0G15 + ZB5AW113)	<b>51.40</b>
					Green	XB5AW13G5 (ZB5AW0G35 + ZB5AW133)	
					Red	XB5AW14G5 (ZB5AW0G45 + ZB5AW143)	
					Yellow	XB5AW15G5 (ZB5AW0G55 + ZB5AW153)	
					Blue	XB5AW16G5 (ZB5AW0G65 + ZB5AW163)	

For additional information, reference Catalog #9001CT0001.

**Non-Illuminated Operators, Momentary—Unmarked**

Shape of Head	Type of Push	Color of Cap	Catalog Number	Price
	Flush, without color cap ▲	...	ZB5AA0	\$5.50
	Flush, with set of 6 color caps	6 colors ■	ZB5AA9	6.50
	Flush	White	ZB5AA1	6.50
		Black	ZB5AA2	
		Green	ZB5AA3	
		Red	ZB5AA4	
		Yellow	ZB5AA5	
		Blue	ZB5AA6	
	Flush with transparent cap, for insertion of legend ♦	Gray	ZB5AA8	8.00
		White	ZB5AA18	
		Green	ZB5AA38	
		Red	ZB5AA48	
		Yellow	ZB5AA58	
		Blue	ZB5AA68	
	Extended	White	ZB5AL1	6.50
		Black	ZB5AL2	
		Green	ZB5AL3	
		Red	ZB5AL4	
		Yellow	ZB5AL5	
		Blue	ZB5AL6	
	Booted (clear) Color of cap unobscured	White	ZB5AP1	12.90
		Black	ZB5AP2	
		Green	ZB5AP3	
		Red	ZB5AP4	
		Yellow	ZB5AP5	
		Blue	ZB5AP6	
	Booted (clear) for insertion of legend ♦ Color of cap unobscured	White	ZB5AP18	14.50
		Green	ZB5AP38	
		Red	ZB5AP48	
		Yellow	ZB5AP58	
		Blue	ZB5AP68	
		White	ZB5AP8	
	Flush Plunger (with high guard)	White	ZB5AA14	16.10
		Black	ZB5AA24	
		Green	ZB5AA34	
		Red	ZB5AA44	
		Yellow	ZB5AA54	
		Blue	ZB5AA64	
	Flush	White	ZB5CA1	13.50
		Black	ZB5CA2	
		Green	ZB5CA3	
		Red	ZB5CA4	
		Yellow	ZB5CA5	
		Blue	ZB5CA6	
	Extended	White	ZB5CL1	13.50
		Black	ZB5CL2	
		Green	ZB5CL3	
		Red	ZB5CL4	
		Yellow	ZB5CL5	
		Blue	ZB5CL6	

▲ Order color cap separately, see page 17-52.  
 ■ Six colored caps included with head (white, black, green, red, yellow, blue).  
 ♦ For legend ordering information see page 17-52.

For additional information, reference Catalog #9001CT0001.

**Non-Illuminated Operators, Momentary—Premarked**



Shape of Head	Type of Push	Marking		Color of Cap	Catalog Number	Price
		Text	Color			
	Flush	I	White	Green	ZB5AA331	9.30
			Black	White	ZB5AA131	
		START	White	Green	ZB5AA333	
			Black	White	ZB5AA133	
		ON	White	Green	ZB5AA341	
			Black	White	ZB5AA141	
		T	White	Green	ZB5AA345	
		O	White	Red	ZB5AA432	
				Black	ZB5AA232	
		STOP	White	Red	ZB5AA434	
				Black	ZB5AA234	
		OFF	White	Red	ZB5AA435	
		UP	Black	White	ZB5AA343	
DOWN	White	Black	ZB5AA344			
↑▲	Black	White	ZB5AA334			
		White	Black	ZB5AA335		
	Extended	O	White	Red	ZB5AL432	9.30
			Black	Black	ZB5AL232	
		STOP	White	Red	ZB5AL434	
				Black	ZB5AL234	
		OFF	White	Red	ZB5AL435	
				Black	ZB5AL235	
	Flush	I	White	Green	ZB5CA331	16.00
		O	White	Red	ZB5CA432	16.00

▲ Cap supplied not clipped-in, allowing orientation of arrow in 4 directions: ↑, ↓, ← or →

**Mushroom Heads, Momentary**





Shape of Head	Diameter of Head	Color of Head	Catalog Number	Price
	30 mm	Black	ZB5AC24	14.70
		Green	ZB5AC34	
		Red	ZB5AC44	
		Yellow	ZB5AC54	
		Blue	ZB5AC64	
	40 mm	Black	ZB5AC2	14.70
		Green	ZB5AC3	
		Red	ZB5AC4	
		Yellow	ZB5AC5	
		Blue	ZB5AC6	
	60 mm	Black	ZB5AR2	17.50
		Green	ZB5AR3	
Red		ZB5AR4		
Yellow		ZB5AR5		
Blue		ZB5AR6		

For additional information, reference Catalog #9001CT0001.







**ZB5AH04**

**Non-Illuminated Push-on/Push-off Operators**

Shape of Head	Type of Push	Color of Push	Catalog Number	Price
	Flush	White	ZB5AH01	<b>\$8.80</b>
		Black	ZB5AH02	
		Green	ZB5AH03	
		Red	ZB5AH04	
		Yellow	ZB5AH05	
		Blue	ZB5AH06	
	Extended	White	ZB5AH1	<b>8.80</b>
		Black	ZB5AH2	
		Green	ZB5AH3	
		Red	ZB5AH4	
		Yellow	ZB5AH5	
		Blue	ZB5AH6	
	Flush	White	ZB5CH01	<b>17.60</b>
		Black	ZB5CH02	
		Green	ZB5CH03	
		Red	ZB5CH04	
		Yellow	ZB5CH05	
		Blue	ZB5CH06	

**Two Head Operators, Momentary**

Shape of Head	Description	Color of Pushers	Degree of Protection	Catalog Number	Price
<b>No Marking</b>					
	Two flush	Green	IP40	ZB5AA8134	<b>\$10.40</b>
		Red	IP66	ZB5AA9134	<b>18.60</b>
		White	IP40	ZB5AA8112	<b>10.40</b>
		Black	IP66	ZB5AA9112	<b>18.60</b>
	One flush One extended	Green	IP40	ZB5AL8334	<b>10.40</b>
		Red	IP66	ZB5AL9334	<b>18.60</b>
		White	IP40	ZB5AL8312	<b>10.40</b>
		Black	IP66	ZB5AL9312	<b>18.60</b>
<b>Premarked</b>					
	Two flush (marked "I") (marked "O")	Green	IP40	ZB5AA8234	<b>12.40</b>
		Red	IP66	ZB5AA9234	<b>20.70</b>
		White	IP40	ZB5AA8212	<b>12.40</b>
		Black	IP66	ZB5AA9212	<b>20.70</b>
	One flush (marked "I") One extended (marked "O")	Green	IP40	ZB5AL8434	<b>12.40</b>
		Red	IP66	ZB5AL9434	<b>20.70</b>
		White	IP40	ZB5AL8412	<b>12.40</b>
		Black	IP66	ZB5AL9412	<b>20.70</b>



**ZB5AL8334**



**ZB5AL8434**



**ZB5AL9334**

For additional information, reference Catalog #9001CT0001.



**Mushroom Heads for Maintained Push Buttons**



ZB5AS844



ZB5AS934



ZB5AT4



ZB5AS54



ZB5AS64

Shape of Head	Type of Push	Diameter of Head	Color	Catalog Number	Price		
	Trigger action Push-pull ■	40 mm	Red	ZB5AT84	\$26.90		
	Trigger action Turn-to-release ■	30 mm	Red	ZB5AS834	56.00		
		40 mm	Red	ZB5AS844	56.00		
	Trigger action Key release (No. 455) ■	30 mm	Red	ZB5AS934	56.00		
		40 mm	Red	ZB5AS944 ▲	56.00		
		60 mm	Red	ZB5AS964	56.00		
	Push-pull	30 mm	Black	ZB5AT24	20.20		
			Red	ZB5AT44			
		40 mm	Black	ZB5AT2	20.20		
			Red	ZB5AT4			
		60 mm	Black	ZB5AX2	23.00		
			Red	ZB5AX4			
	Turn-to-release	30 mm	Black	ZB5AS42	39.00		
			Red	ZB5AS44			
		40 mm	Black	ZB5AS52	39.00		
			Red	ZB5AS54			
			Yellow	ZB5AS55			
		60 mm	Black	ZB5AS62	44.80		
			Red	ZB5AS64			
			Key release (No. 455)	30 mm	Black	ZB5AS72	56.00
					Red	ZB5AS74	
40 mm	Black			ZB5AS12	56.00		
	Red			ZB5AS14 ▲			
60 mm	Black			ZB5AS22	56.00		
	Red			ZB5AS24			

▲ Other key numbers:  
 —key no. 421E: add the suffix 12 to the catalog number.  
 —key no. 458A: add the suffix 10 to the catalog number.  
 —key no. 520E: add the suffix 14 to the catalog number.  
 —key no. 3131A: add the suffix 20 to the catalog number.  
 Example:  
 The catalog number for a Ø 40 mm red mushroom head for a trigger action, maintained push button, with release by key no. 421E becomes: ZB5AS94412.  
 ■ Trigger action mushroom heads are tamper proof in that a change of contact state is not possible by teasing or floating the operator.

**Circular Legends for Emergency Stop Mushroom Heads (yellow background)**



ZBY9330

Diameter	Text	Catalog Number	Price
60 mm	Blank	ZBY9101	\$1.70
	EMERGENCY STOP	ZBY9330	
90 mm	Blank	ZBY8101	
	EMERGENCY STOP	ZBY8330	

For additional information, reference Catalog #9001CT0001.

# Push Buttons—XB5 22 mm Selector Switches

17 PUSH BUTTONS AND OPERATOR INTERFACE



**ZB5AD\***  
Standard Lever



**ZB5AJX\***  
Extended Lever

## Non-Illuminated Selector Switches ■

Color▲	Number and Type of Positions				Price
			Standard Lever	Extended Lever	
Catalog Number					
Black	2-maintained		ZB5AD2	ZB5AJ2	\$12.00
Black	2-momentary from right to left		ZB5AD4	ZB5AJ4	14.70
Black	3-maintained		ZB5AD3	ZB5AJ3	12.00
Black	3-momentary to center		ZB5AD5	ZB5AJ5	14.70
Black	3-momentary from left to center		ZB5AD7	ZB5AJ7	14.70
Black	3-momentary from right to center		ZB5AD8	ZB5AJ8	14.70

▲ For colored lever, add the following code to the end of catalog number: 01—white, 03—green, 04—red, 05—yellow, 06—blue (Example: ZB5AD204).

## Non-Illuminated Key Switches■

Shape of Head	Type of Operator	Number and Type of Positions	Catalog Number ◆	Price		
	Key (No. 455)	2-maintained		ZB5AG2	\$44.80	
				ZB5AG4		
		2-momentary from right to left		ZB5AG6		
			3-maintained			ZB5AG0
				ZB5AG3		
				ZB5AG5		
				ZB5AG9		
				ZB5AG09		
				ZB5AG1		
		3-momentary from left to center		ZB5AG7		\$58.00
		3-momentary to center		ZB5AG8		
		3-momentary from right to center		ZB5AG08		

The symbol indicates key withdrawal position(s).

■ For actuation of outside contacts only. Center position not used.

◆ Other key numbers:

- key no. 421E: add the suffix 12 to the catalog number.
- key no. 458A: add the suffix 10 to the catalog number.
- key no. 520E: add the suffix 14 to the catalog number.
- key no. 3131A: add the suffix 20 to the catalog number.

Example: The catalog number for a head with key no. 421E for a 2 position maintained, lockable selector switch, with key withdrawal from the left-hand position, becomes: ZB5AG212



**ZB5AG\***

## Selector Switch Sequence (using contact block assemblies, page 17-48; or complete bodies, page 17-48)

2 Position Selector Switch		
		Contact block guide ★
O	X	1 N.O. (left or right)
X	O	1 N.C. (left or right)
O	X	1 N.O. and 1 N.C.
X	O	

3 Position Selector Switch			
			Contact block guide ★
X	O	O	1 N.O. (left)
O	X	O	2 N.C. wired in <b>series</b> (side by side)
O	O	X	1 N.O. (right)
X	X	O	1 N.C. (right)
O	X	X	1 N.C. (left)
X	O	X	2 N.O. wired in <b>parallel</b> (side by side)

★ As viewed from the front of the panel.

For additional information, reference Catalog #9001CT0001.

**Reset Operators**



**XB5AA**

Shape of Head	Actuation Distance		Text	Color	Catalog Number	Price
	IN	mm				
<b>Flush</b>	<b>Adjustable Shaft</b>					
	0.67–4.72	17–120	Without	Green	XB5AA831	\$17.10
				Red	XB5AA841	
				Blue	XB5AA861	
			O	XB5AA84101	20.70	
	R	XB5AA86102	20.70			
	4.72–10.12	120–257	Without	Green	XB5AA832	19.70
				Red	XB5AA842	
				Blue	XB5AA862	
O			XB5AA84201	22.80		
R	XB5AA86202	22.80				
<b>Extended</b>						
	0.67–4.72	17–120	O	Red	XB5AL84101	20.70
	4.72–10.12	120–257	O	Red	XB5AL84201	22.80

**Potentiometer Operator (with Mounting Collar)**

Shape of Head	Description	Application	Catalog Number	Price
	For potentiometer with shaft length 1.73 to 1.97 in. (44 to 50 mm) (potentiometer not included)	For shaft Ø 0.25 in. (6.35 mm)	ZB5AD922	\$71.00
		For shaft Ø 0.24 in. (6 mm)	ZB5AD912	

**Joystick Controllers (54 mm, Extended Operating Shaft) ▲**



**XD5PA12**

Description	Contact Operation	Action	Catalog Number	Price
2 direction 	1 step 1 N.O. contact per direction	Maintained	XD5PA12	\$125.00
		Momentary	XD5PA22	
4 direction 	1 step 1 N.O. contact per direction	Maintained	XD5PA14	158.00
		Momentary	XD5PA24	

▲ It is not permissible to use standard contact blocks ZBE10• (single) or ZBE20• (double)

**Legends for Joystick Controllers**

Description	For use with		Catalog Number	Price
Legends 30 x 48 mm for engraving	2 direction	Black one side Red reverse	ZBG2201	\$1.70
		White one side Yellow reverse	ZBG2401	
Legends 48 x 48 mm for engraving	4 direction	Black one side Red reverse	ZBG4201	
		White one side Yellow reverse	ZBG4401	

**Hour Counters ■**



**XB5DS•**

Characteristics	Supply Voltage	Catalog Number	Price
Indication 0–9999.9	12–24 Vdc or Vac, 50/60 Hz	XB5DSB	\$174.00
	120 Vac, 60 Hz	XB5DSG	
	230–240 Vac, 50 Hz	XB5DSM	

**Buzzer ■**



**XB5KS•**

Characteristics	Supply Voltage	Catalog Number	Price
80 db buzzer, continuous or intermittent (IP40 NEMA 1)	12–24 Vdc or Vac, 50/60 Hz	XB5KSB	\$83.00
	120 Vac, 60 Hz	XB5KSG	
	230–240 Vac, 50 Hz	XB5KSM	

■ UR E191025, XHNR2 and XHNR8.

**Two Position Toggle Switch**



**ZB5AD28**

Shape of Head	Color	Type of Positions	Catalog Number	Price
	Black	Maintained	ZB5AD28	\$23.30
	Black	Momentary	ZB5AD48	

For additional information, reference Catalog #9001CT0001.

# Push Buttons—XB5 22 mm

## Pilot Lights



ZB5AV053





ZB5AV01



ZB5CV063

### Pilot Light Heads

Shape of Head	For use with Body Comprising Light Module Type	Color of Lens	Catalog Number	Price
	PROTECTED LED® only	White	ZB5AV013	<b>\$3.80</b>
		Green	ZB5AV033	
		Red	ZB5AV043	
		Yellow	ZB5AV053	
		Blue	ZB5AV063	
	PROTECTED LED only Fresnel (jeweled) lens	White	ZB5AV013S	<b>3.80</b>
		Green	ZB5AV033S	
		Red	ZB5AV043S	
		Amber	ZB5AV053S	
		Blue	ZB5AV063S	
	For BA9s incandescent bulb, neon or LED only	White	ZB5AV01	<b>3.80</b>
		Green	ZB5AV03	
		Red	ZB5AV04	
		Yellow	ZB5AV05	
		Blue	ZB5AV06	
	For BA9s incandescent bulb, neon or LED Fresnel (jeweled) lens	White	ZB5AV01S	<b>3.80</b>
		Green	ZB5AV03S	
		Red	ZB5AV04S	
		Amber	ZB5AV05S	
Blue		ZB5AV06S		
	PROTECTED LED only	White	ZB5CV013	<b>13.50</b>
		Green	ZB5CV033	
		Red	ZB5CV043	
		Yellow	ZB5CV053	
		Blue	ZB5CV063	

For additional information, reference Catalog #9001CT0001.



**ZB5AV6**

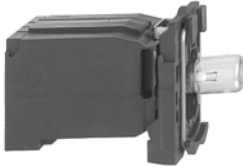

**ZB5AV3**

**Complete Bodies (Mounting Collar + Light Module for BA9s Incandescent Bulb, Neon or LED)**

Description	Light Source	Supply Voltage (V)	Catalog Number	Price
<b>Screw clamp terminal connections</b>				
Direct supply	BA9s bulb 2.4 W max. Not included ▲	≤ 250	ZB5AV6	\$19.30
Direct supply	BA9s incandescent bulb included	24 V 2 Watt	ZB5AV624	24.60
Direct supply	BA9s incandescent bulb included	120 V 2.4 Watt	ZB5AV6120	24.60
Transformer type 1.2 VA, 6 V secondary	BA9s incandescent bulb included	110–120 Vac 50/60 Hz	ZB5AV3	49.20
		230–240 Vac 50/60 Hz	ZB5AV4	
		400–50 Hz	ZB5AV5	
		440–480 Vac 60 Hz	ZB5AV8	
		550–600 Vac 60 Hz	ZB5AV9	

▲ Order bulb separately, see page 17-53.

**Complete Bodies (Mounting Collar + Light Module with PROTECTED LED®) ■**



**ZB5AV\*\***

Light Source	Supply Voltage	Color of Light Source	Catalog Number	Price
<b>Screw clamp terminal connections</b>				
Protected <b>LED</b>	12 Vac/dc	White	ZB5AVJ1	\$28.60
		Green	ZB5AVJ3	
		Red	ZB5AVJ4	
		Yellow	ZB5AVJ5	
		Blue	ZB5AVJ6	
		White	ZB5AVB1	
	Green	ZB5AVB3		
	Red	ZB5AVB4		
	Yellow	ZB5AVB5		
	Blue	ZB5AVB6		
	24–120 Vac/dc	White	ZB5AVBG1	28.60
		Green	ZB5AVBG3	
		Red	ZB5AVBG4	
		Yellow	ZB5AVBG5	
		Blue	ZB5AVBG6	
		110–120 Vac	White	
	Green		ZB5AVG3	
	Red		ZB5AVG4	
Yellow	ZB5AVG5			
Blue	ZB5AVG6			
Flashing Protected <b>LED</b>	24 Vac/dc		White	ZB5AV18B1
		Green	ZB5AV18B3	
		Red	ZB5AV18B4	
		Yellow	ZB5AV18B5	
		Blue	ZB5AV18B6	
		110–120 Vac	White	ZB5AV18G1
	Green		ZB5AV18G3	
	Red		ZB5AV18G4	
	Yellow		ZB5AV18G5	
	Blue		ZB5AV18G6	

■ For Quick-Connect version, add "3" to the end of the catalog number Example: ZB5AVJ13 (Quick-Connect size 1 x 0.250" or 2 x 0.110").

For additional information, reference Catalog #9001CT0001.



**ZB5AW313**



**ZB5AW363**



**ZB5AW143**









**ZB5CW313**





**ZB5AW33**



**Heads for Momentary Illuminated Push Buttons**

Shape of Head	Type of Push	Color	Catalog Number	Price
<b>Only use with PROTECTED LED® light modules</b>				
	Flush	White	ZB5AW313	<b>\$9.30</b>
		Green	ZB5AW333	
		Red	ZB5AW343	
		Yellow	ZB5AW353	
		Blue	ZB5AW363	
	Flush with clear boot	White	ZB5AW513	<b>15.50</b>
		Green	ZB5AW533	
		Red	ZB5AW543	
		Yellow	ZB5AW553	
		Blue	ZB5AW563	
	Flush for insertion of legend	White	ZB5AA18	<b>8.00</b>
		Green	ZB5AA38	
		Red	ZB5AA48	
		Yellow	ZB5AA58	
		Blue	ZB5AA68	
	Extended	White	ZB5AW113	<b>6.50</b>
		Green	ZB5AW133	
		Red	ZB5AW143	
		Yellow	ZB5AW153	
		Blue	ZB5AW163	
	Flush for insertion of legend	White	ZB5CW313	<b>13.50</b>
		Green	ZB5CW333	
		Red	ZB5CW343	
		Yellow	ZB5CW353	
		Blue	ZB5CW363	
	Extended	White	ZB5CW113	<b>13.50</b>
		Green	ZB5CW133	
		Red	ZB5CW143	
		Yellow	ZB5CW153	
		Blue	ZB5CW163	

**Only use with light modules for a BA9s incandescent bulb, neon or LED**

	Flush	White	ZB5AW31	<b>9.30</b>
		Green	ZB5AW33	
		Red	ZB5AW34	
		Yellow	ZB5AW35	
		Blue	ZB5AW36	
		Clear	ZB5AW37	
	Extended	White	ZB5AW11	<b>6.50</b>
		Green	ZB5AW13	
		Red	ZB5AW14	
		Yellow	ZB5AW15	
		Blue	ZB5AW16	
		Clear	ZB5AW17	

**Illuminated Push-on/Push-off Operators**

Shape of Head	Type of Push	Color of Lens	Catalog Number	Price
<b>Only use with PROTECTED LED light modules</b>				
	Flush	White	ZB5AH013	<b>\$12.40</b>
		Green	ZB5AH033	
		Red	ZB5AH043	
		Yellow	ZB5AH053	
		Blue	ZB5AH063	
	Extended	White	ZB5AH13	<b>9.80</b>
		Green	ZB5AH33	
		Red	ZB5AH43	
		Yellow	ZB5AH53	
		Blue	ZB5AH63	

For additional information, reference Catalog #9001CT0001.



ZB5AW833743



ZB5AW823743



ZB5AW843743



ZB5AW7



ZB5AK1213



ZB5AK1463

**Two Button with Clear Pilot Light, Momentary (IP40) ▲**

Shape of Head	Description	Color of Pushers	Catalog Number	Price
<b>Only use with PROTECTED LED® light modules (PROTECTED LED determines pilot light color)</b>				
	1 flush 1 central pilot light 1 flush	Black Red	ZB5AW812743	\$14.50
		Green Red	ZB5AW813743	
		White Black	ZB5AW811723	
	1 flush 1 central pilot light 1 extended	Black Red	ZB5AW832743	14.50
		Green Red	ZB5AW833743	
		White Black	ZB5AW831723	
<b>Only use with PROTECTED LED light modules (PROTECTED LED determines pilot light color)—premarked</b>				
	1 flush (marked "I") 1 central pilot light 1 flush (marked "O")	Black Red	ZB5AW822743	16.60
		Green Red	ZB5AW823743	
		White Black	ZB5AW821723	
	1 flush (marked "I") 1 central pilot light 1 extended (marked "O")	Black Red	ZB5AW842743	16.60
		Green Red	ZB5AW843743	
		White Black	ZB5AW841723	

▲ For IP66 degree of protection, install clear sealing boot ZBW008, see page 17-54.

**Heads for Maintained Illuminated Push Buttons**

Shape of Head	Type of Push	Color	Catalog Number	Price
<b>Only use with PROTECTED LED light modules</b>				
	Turn-to-Release Mushroom (40 mm)	White Green Red Yellow Blue	ZB5AW713 ZB5AW733 ZB5AW743 ZB5AW753 ZB5AW763	\$31.50

**Illuminated Selector Switches, Standard Lever**

Shape of Head	Number and Type of Positions	Catalog Number ■	Price
<b>Only use with PROTECTED LED light modules</b>			
	2-maintained		ZB5AK12■3 \$17.50
	2-momentary from right to left		ZB5AK14■3 25.70
	3-maintained		ZB5AK13■3 17.50
	3-momentary to center		ZB5AK15■3 25.70
	3-momentary from right to center		ZB5AK18■3 25.70
	3-momentary from left to center		ZB5AK17■3 25.70

■ Designate color as follows: 1—white, 3—green, 4—red, 5—yellow, 6—blue

**Selector Switch Sequence (using contact block assemblies, page 17-48; or complete bodies, page 17-48)**

2 Position Selector Switch		
		Contact block guide ♦
O	X	1 N.O. (left or right)
X	O	1 N.C. (left or right)
O	X	1 N.O. and
X	O	1 N.C.

3 Position Selector Switch			
			Contact block guide ♦
X	O	O	1 N.O. (left)
O	X	O	2 N.C. wired in series (side by side)
O	O	X	1 N.O. (right)
X	X	O	1 N.C. (right)
O	X	X	1 N.C. (left)
X	O	X	2 N.O. wired in parallel (side by side)

♦ As viewed from the front of the panel.

For additional information, reference Catalog #9001CT0001.



**ZB5AZ101**

**Contact Blocks (Mounting Collar with Contact Blocks)**

Description	Type of Contact		Catalog Number	Price
	N.O.	N.C.		
Screw clamp terminal connections	1	...	ZB5AZ101	\$11.00
	...	1	ZB5AZ102	11.00
	2	...	ZB5AZ103	19.10
	...	2	ZB5AZ104	19.10
	1	1	ZB5AZ105	19.10
	1	2	ZB5AZ141	27.30

- ▲ For Quick-Connect version add "3" to the end of the catalog number Example: ZB5AZ1013 (Quick-Connect size 1 x 0.250" or 2 x 0.110").
- For Ring Tongue compatible blocks add "9" to the end of the catalog number (Example: ZB5AZ1029).
- ◆ Electrical components with connection by printed circuit board pins are available. Consult local field office for details.
- ★ Electrical components with connection by plug-in connector are available. Consult local field office for details.

**Complete Bodies (Mounting Collar + Single Contact Block + Light Module with PROTECTED LED®)**

Light Source	Type of Contact ▲		Color	Supply Voltage		Price
	N.O.	N.C.		24 Vac/dc	110–120 Vac	
				Catalog Number		

**Screw clamp terminal connections**

	1	...	White	ZB5AW0B11	ZB5AW0G11	\$36.70
			Green	ZB5AW0B31	ZB5AW0G31	
			Red	ZB5AW0B41	ZB5AW0G41	
			Yellow	ZB5AW0B51	ZB5AW0G51	
			Blue	ZB5AW0B61	ZB5AW0G61	
	...	1	White	ZB5AW0B12	ZB5AW0G12	36.70
			Green	ZB5AW0B32	ZB5AW0G32	
			Red	ZB5AW0B42	ZB5AW0G42	
			Yellow	ZB5AW0B52	ZB5AW0G52	
	2	...	White	ZB5AW0B13	ZB5AW0G13	44.90
			Green	ZB5AW0B33	ZB5AW0G33	
			Red	ZB5AW0B43	ZB5AW0G43	
			Yellow	ZB5AW0B53	ZB5AW0G53	
	1	1	White	ZB5AW0B15	ZB5AW0G15	44.90
			Green	ZB5AW0B35	ZB5AW0G35	
			Red	ZB5AW0B45	ZB5AW0G45	
			Yellow	ZB5AW0B55	ZB5AW0G55	
			Blue	ZB5AW0B65	ZB5AW0G65	



**ZB5AW0\*\*1**

**Protected LED**

**Mounting Collar, Contact Block and Light Module (with screw clamp terminal connections) ▲**

Supply	Light Source	Supply Voltage	Type of Contact ▲		Color of Light Source	Catalog Number	Price
			N.O.	N.C.			

**Screw clamp terminal connections**

Direct supply	BA9s 2.4 W max. bulb Not included ■	≤ 250 Vac/dc	1	...	...	ZB5AW061	\$27.40
			...	1	...	ZB5AW062	27.40
			2	...	...	ZB5AW063	35.60
			1	1	...	ZB5AW065	35.60
			1	...	...	ZB5AW031	57.00
Transformer type 1.2 VA, 6 V secondary	BA9s incandescent bulb included	110–120 Vac 50/60 Hz	1	1	...	ZB5AW035	65.00
			1	...	...	ZB5AW041	57.00
		230–240 Vac 50/60 Hz	1	1	...	ZB5AW045	65.00
			1	...	...	ZB5AW081	57.00
		440–480 Vac 60 Hz	1	1	...	ZB5AW085	65.00

- ▲ Can be fitted with additional contact blocks, see page 17-49.
- Order bulb separately, see page 17-53.



**ZB5AW065**



**ZB5AW035**

For additional information, reference Catalog #9001CT0001.

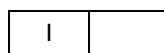





ZB5AZ009

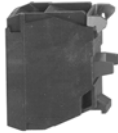

ZBE101



ZBE203

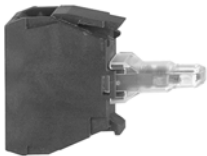

ZBVB•

**Body/Mounting Collar**

For use with	Catalog Number	Price
Electrical block (contact or light module)	ZB5AZ009	\$2.70

**Add-On Contact Block (with screw clamp terminal connections) ★▼**

Description	Type of Contact		Catalog Number	Price
	N.O.	N.C.		
Standard single contact blocks▲■	1	...	ZBE101	\$8.20
	...	1	ZBE102	8.20
Standard double contact blocks▲■	2	...	ZBE203	16.60
	...	2	ZBE204	16.60
	1	1	ZBE205	16.60
Special contact blocks (for low power switching and dust protected)◆	1	...	ZBE1016	16.40
	...	1	ZBE1026	16.40

▲ For Quick-Connect version add "3" to the end of the catalog number (Example: ZBE1013) (Quick-Connect size 1 x 0.250" or 2 x 0.110").  
■ For Ring Tongue compatible blocks add "9" to the end of the catalog number (Example: ZBE1029).

**Light Modules (with screw clamp terminal connections)★▼**

Description	Supply Voltage	Color of Light Source	Catalog Number	Price
	12 Vac/dc	White	ZBVJ1	\$25.90
		Green	ZBVJ3	
		Red	ZBVJ4	
		Yellow	ZBVJ5	
		Blue	ZBVJ6	
		White	ZBVB1	
Green	ZBVB3			
Red	ZBVB4			
Yellow	ZBVB5			
Blue	ZBVB6			
White	ZBVG1	25.90		
Green	ZBVG3			
Red	ZBVG4			
Yellow	ZBVG5			
Blue	ZBVG6			
White	ZBVBG1		25.90	
Green	ZBVBG3			
Red	ZBVBG4			
Yellow	ZBVBG5			
Blue	ZBVBG6			
White	ZBVM1	25.90		
Green	ZBVM3			
Red	ZBVM4			
Yellow	ZBVM5			
Blue	ZBVM6			
Direct supply for BA9s 2.4 W max. bulb Not included	≤ 250 Vac/dc		...	ZBV6
Super Bright	12 Vac/dc	White	ZBVJ1S	33.60
		Green	ZBVJ3S	
		Red	ZBVJ4S	
		Yellow	ZBVJ5S	
		Blue	ZBVJ6S	
	24 Vac/dc	White	ZBVB1S	33.60
		Green	ZBVB3S	
		Red	ZBVB4S	
		Yellow	ZBVB5S	
		Blue	ZBVB6S	
	48–120 Vac	White	ZBVG1S	33.60
		Green	ZBVG3S	
		Red	ZBVG4S	
		Yellow	ZBVG5S	
		Blue	ZBVG6S	

◆ Cannot stack additional contact blocks onto these blocks.  
★ Electrical components with connection by printed circuit board pins are available. Consult local field office for details.  
▼ Electrical components with connection by plug-in connector are available. Consult local field office for details.

For additional information, reference Catalog #9001CT0001.

### Standard (30 x 40 mm) Legend Plates for 8 x 27 mm Legends▲

Description	Legend		Catalog Number	Price
	Color	Text		
Without legend insert	...	...	ZBZ32	\$1.00
With blank legend insert (for engraving)	Black or red background	...	ZBY2101	1.70
	White or yellow background	...	ZBY4101	
Custom legend plate and insert (specify engraving) 2 lines of 11 characters (including spaces) maximum per line	Black background	White	ZBY2002	7.10
	Red background	White	ZBY2004	
	White background	Black	ZBY4001	
	Yellow background	Black	ZBY4005	
With international language marked legend	Black or red background■	O (black background)	ZBY2146	1.70
		O (red background)	ZBY2931	
		I	ZBY2147	
		II	ZBY2148	
		O-I	ZBY2178	
		I-II	ZBY2179	
With English language marked legend	Black or red background■	AUTO	ZBY2115	1.70
		AUTO-HAND	ZBY2364	
		AUTO-O-HAND	ZBY2385	
		CLOSE	ZBY2314	
		DOWN	ZBY2308	
		EMERGENCY STOP	ZBY2330	
		FAST	ZBY2328	
		FORWARD	ZBY2305	
		FOR-REV	ZBY2371	
		HAND	ZBY2316	
		HAND-OFF-AUTO	ZBY2387	
		INCH	ZBY2321	
		JOG	ZBY2382	
		LEFT	ZBY2310	
		OFF	ZBY2312	
		OFF-ON	ZBY2367	
		ON	ZBY2311	
		OPEN	ZBY2313	
		POWER ON	ZBY2326	
		RESET (red background)	ZBY2323	
		RESET (black background)	ZBY2322	
		REVERSE	ZBY2306	
		RIGHT	ZBY2309	
		RUN	ZBY2334	
		SLOW	ZBY2327	
		START	ZBY2303	
		STOP	ZBY2304	
		STOP-START	ZBY2366	
UP	ZBY2307			

▲ For legends, see page 17-51.

■ Start functions: white letters on black background. Stop functions: white letters on red background (unless otherwise specified above).

### Standard (30 x 50 mm) Legend Plates for 18 x 27 mm Legends

Description	For use with	Color	Catalog Number	Price
Without legend insert	Circular and square heads	...	ZBZ33	\$1.00
With blank legend insert	Circular and square heads	Black or red background	ZBY6101	1.70
		White or yellow background	ZBY6102	



ZBZ33

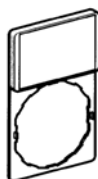

ZBY610

For additional information, reference Catalog #9001CT0001.

**Marked Legends for 8 x 27 mm (for 30 x 40 mm legend holders ZBZ32)**



Color	Marking	Text	Catalog Number	Price
Black or red background▲	International	O (black background) O (red background) I II O-I I-II I-O-II	ZBY02146 ZBY02931 ZBY02147 ZBY02148 ZBY02178 ZBY02179 ZBY02186	\$0.83
	English	AUTO AUTO-HAND AUTO-O-HAND CLOSE DOWN EMERGENCY STOP FAST FORWARD FOR-REV HAND HAND-OFF-AUTO INCH JOG LEFT OFF OFF-ON ON OPEN POWER ON RESET (red background) RESET (black background) REVERSE RIGHT RUN SLOW START STOP STOP-START UP	ZBY02115 ZBY02364 ZBY02385 ZBY02314 ZBY02308 ZBY02330 ZBY02328 ZBY02305 ZBY02371 ZBY02316 ZBY02387 ZBY02321 ZBY02382 ZBY02310 ZBY02312 ZBY02367 ZBY02311 ZBY02313 ZBY02326 ZBY02323 ZBY02322 ZBY02306 ZBY02309 ZBY02334 ZBY02327 ZBY02303 ZBY02304 ZBY02366 ZBY02307	0.83

▲ Start functions: white letters on black background. Stop functions: white letters on red background (unless otherwise specified above).

**Legends for Customer Engraving (inserts only)**

Description	For use with	Color	Catalog Number	Price
8 x 27 mm	30 x 40 mm legend holders	Black or red background	ZBY0101	\$0.83
		White or yellow background	ZBY0102	
18 x 27 mm	30 x 50 mm legend holders	Black or red background	ZBY5101	
		White or yellow background	ZBY5102	

**Legends for Factory Engraving (inserts only)**

Description	For use with	Color	Text	Catalog Number	Price
8 x 27 mm Custom legend/insert only (specify engraving) 2 lines of 11 characters (including spaces) maximum per line	30 x 40 mm legend holders	Black background	White	ZBY01002	\$6.10
		Red background	White	ZBY01004	
		White background	Black	ZBY01001	
		Yellow background	Black	ZBY01005	
18 x 27 mm Custom legend/insert only (specify engraving) 3 lines of 11 characters (including spaces) maximum per line	30 x 50 mm legend holders	Black background	White	ZBY05002	6.10
		Red background	White	ZBY05004	
		White background	Black	ZBY05001	
		Yellow background	Black	ZBY05005	

For additional information, reference Catalog #9001CT0001.

# Push Buttons—XB5 22 mm

## Accessories

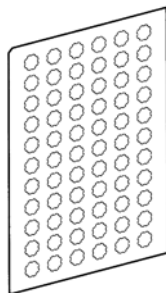

ZBY1101

### Sheets of Legends for Push Buttons, Switches, and Pilot Lights

Description	Marking	Text	Catalog Number	Price	
Sheets of 66 circular peel-off transparent self-adhesive legends	Blank—Round		ZBY1101	\$3.10	
	Blank—Square legends		ZBCY1101	3.10	
	International	O		ZBY1146	5.20
		I		ZBY1147	
		II		ZBY1148	
		III		ZBY1149	
		STOP		ZBY1304	
		→		ZBY1912	
	English	HAND		ZBY1316	5.20
		OFF		ZBY1312	
		ON		ZBY1311	
		START		ZBY1303	
	SIS Label Software	Legend Design Software: English, French, German, Spanish, Italian		XYB2U	52.00

### Push Button Caps—Unmarked

For use with	Type of Push	Color	Catalog Number	Price
ZB5AA0 push button heads supplied with cap	Flush	White	ZBA1	1.00
		Black	ZBA2	
		Green	ZBA3	
		Red	ZBA4	
		Yellow	ZBA5	
		Blue	ZBA6	
		6 colors ▲	ZBA9	
	Extended	White	ZBL1	1.00
		Black	ZBL2	
		Green	ZBL3	
		Red	ZBL4	
		Yellow	ZBL5	
		Blue	ZBL6	
		6 colors ▲	ZBL9	



ZBA•



ZBL•

### Push Button Caps—Marked

For use with	Type of Push	Marking		Color of Cap	Catalog Number	Price
		Text	Color			
ZB5AA0 push button heads supplied with cap	Flush	I ■	White	Green	ZBA331	\$2.10
			Black	White	ZBA131	
		START ■	White	Green	ZBA333	
			Black	White	ZBA133	
		ON	White	Green	ZBA341	
			Black	White	ZBA141	
		UP ■	Black	White	ZBA343	
		DOWN ■	White	Black	ZBA344	
		⊕ ■	White	Green	ZBA345	
		⊕	White	Black	ZBA245	
		⬆	White	Green	ZBA346	
		↑	Black	White	ZBA334♦	
			White	Black	ZBA335♦	
		O ■	White	Red	ZBA432	
				Black	ZBA232	
		STOP ■	White	Red	ZBA434	
				Black	ZBA234	
		OFF	White	Red	ZBA435	
				Black	ZBA235	
		R ■	White	Blue	ZBA639	



ZBA•33

▲ Set of 6 different colored caps: white, black, green, red, yellow, blue.

■ Double injection molded marking.

♦ Cap supplied not clipped-in, allowing orientation of arrow in 4 directions: ↑, ↓, ← or →

For additional information, reference Catalog #9001CT0001.

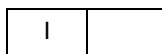

**Accessories**



**ZBZ160\***



**ZB4BZ6\***



**ZB4SZ3**



**ZB5SZ3**



**DLCE\*\*\***



**DL1CF\*\*\***



**XBFX13**



**ZBZ8**



**ZBG455**

Description	Application	Color	Catalog Number	Price
Metal guards Padlockable	For Emergency stop function only with the following Ø 40 mm trigger-action push buttons: XB4BT8* XB4BS8* XB4BS9* ZB4BT8* ZB4BS8* ZB4BS9*	Chromium Plated	ZBZ1600	\$54.00
		Black	ZBZ1602	
		Red	ZBZ1604	
		Yellow	ZBZ1605	
		Blue	ZBZ1606	
Plastic guards	Round Guard for 40 mm EMO Mushroom Operators	Yellow	ZB4BZ1905	12.90
	Narrow Flange Guard for 40 mm EMO Mushroom Operators	Yellow	ZB4BZ2005	
Padlockable flaps	For push buttons	Black	ZB4BZ62	16.40
		Red	ZB4BZ64	
Plastic blanking plug, round▲	For Ø 22 mm units with round heads	Black	ZB5SZ3	5.50
Plastic blanking plug, square▲	For Ø 22 mm units with square heads	Black	ZB5SZ5	5.50
Square insert	To give square appearance to ZB5A round heads	Black	ZB5AZ31	1.00
Mounting nut	Operator	...	ZB5AZ901	2.20
Tool	For tightening mounting nut ZB5AZ901	...	ZB5AZ905	6.20
Plate	Anti-rotation of head	...	ZB5AZ902	1.00

▲ Mounting nut included with blanking plug.

**BA9s Bulbs and Associated Accessories**

Description	Characteristics	Catalog Number	Price
Replacement bulbs (Type BA9s) Incandescent	6 V, 1.2 W	DL1CB006	\$5.50
	12 V, 2 W	DL1CE012	
	24 V, 2 W	DL1CE024	
	120–130 V, 2.4 W	DL1CE130	
Neon bulbs	120–130 V	DL1CF110	7.60
	230–240 V	DL1CF220	
Bulb extractor	...	XBFX13	5.50
Lens cap tightening tool	Illuminated push buttons with flush push	ZBZ8	3.10
Power driver bits for mounting and wiring (package of 5)	Cross headed screw (POZIDRIV type 1)	ZB4BZ905	25.90
Mounting Adapter	For mounting 22 mm push button in 30 mm knockout	ZBZ41	5.20

**Replacement Keys for Emergency Stop Push Buttons and Selector Switches**

Description	Key Number	Catalog Number	Price
Set of 2 keys	455	ZBG455	\$5.50
	421E	ZBG421E	
	458A	ZBG458A	
	520E	ZBG520E	
	3131A	ZBG3131A	

For additional information, reference Catalog #9001CT0001.

# Push Buttons—XB5 22 mm

## Accessories



ZBP0

### Clear Boots

Description	For use with	Catalog Number	Price
Single boots	Booted push buttons with circular head	ZBP0	\$6.20
	Booted push buttons with circular head used in food industry applications	ZBP0A	6.20
Double boots	Double-headed push buttons, with or without pilot light	ZBW008	16.40
	Double-headed push buttons used in food industry applications	ZBW008A	16.40

### Lens Caps

For use with	Color	Catalog Number	Price
--------------	-------	----------------	-------

#### Lens caps for PROTECTED LED® light modules

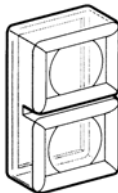

ZBW008

Pilot lights	White	ZBV0113	2.70
	Green	ZBV0133	
	Red	ZBV0143	
	Yellow	ZBV0153	
	Blue	ZBV0163	
Illuminated push buttons with flush push	White	ZBW9113	2.70
	Green	ZBW9133	
	Red	ZBW9143	
	Yellow	ZBW9153	
	Blue	ZBW9163	
Illuminated push buttons with extended push	White	ZBW9313	2.70
	Green	ZBW9333	
	Red	ZBW9343	
	Yellow	ZBW9353	
	Blue	ZBW9363	



ZBV01•3

#### Circular lens caps for BA9s light modules

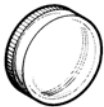

ZBV01•

Pilot lights	White	ZBV011	2.70
	Green	ZBV013	
	Red	ZBV014	
	Yellow	ZBV015	
	Blue	ZBV016	
	Clear	ZBV017	
Illuminated push buttons with flush push	White	ZBW911	2.70
	Green	ZBW913	
	Red	ZBW914	
	Yellow	ZBW915	
	Blue	ZBW916	
	Clear	ZBW917	
Illuminated push buttons with extended push	White	ZBW931	2.70
	Green	ZBW933	
	Red	ZBW934	
	Yellow	ZBW935	
	Blue	ZBW936	
	Clear	ZBW937	



#### Square lens caps for PROTECTED LED light modules (ZB5C operators only)

Pilot lights	White	ZBCV0113	4.70
	Green	ZBCV0133	
	Red	ZBCV0143	
	Yellow	ZBCV0153	
	Blue	ZBCV0163	
Illuminated push buttons with flush push	White	ZBCW9113	4.70
	Green	ZBCW9133	
	Red	ZBCW9143	
	Yellow	ZBCW9153	
	Blue	ZBCW9163	
Illuminated push buttons with extended push	White	ZBCW9313	4.70
	Green	ZBCW9333	
	Red	ZBCW9343	
	Yellow	ZBCW9353	
	Blue	ZBCW9363	

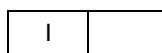
For additional information, reference Catalog #9001CT0001.



**Environment**

<b>Conforming to Standards</b>	Types K, KX, SK, and T: UL508, IEC 947-5-1, VDE 0106, CSA
<b>Approval</b>	<p>UL: Push Buttons and Selector Switches—Pilot Lights and Illuminated Push Buttons Full Voltage and Resistor (120 V max.); Pilot Lights and Illuminated Push Buttons Transformer.</p> <p style="text-align: center;">  File E42259 CCN NKCR         </p> <p>CSA: Push Buttons and Selector Switches—Pilot Lights and Illuminated Push Buttons Full Voltage and Resistor (120 V max.); Pilot Lights and Illuminated Push Buttons Transformer.</p> <p style="text-align: center;">  File LR25490 Class 3211 03         </p> <p>CE: Marked</p> <p style="text-align: center;">  Marked         </p>
<b>Degree of Protection</b>	Type K: NEMA 1, 2, 3, 3R, 4, 6, 12, and 13; Types KX and SK: NEMA 1, 2, 3, 3R, 4, 4X, 6, 12, and 13; Type T: NEMA 1, 2, 12, and 13.

**Contact Block Characteristics**

<b>Nominal Thermal Current</b>	UL508; NEMA A600-Q600, 10 A continuous thermal
<b>Rated Power</b>	AC-15 (3 A @ 240 Vac) and DC-13 (0.55 A @ 125 Vdc)
<b>Cabling</b>	Type KA: Screw and captive clamp terminals. Recommended torque 7 in-lb Capacity: Minimum #24 AWG, solid or stranded; Maximum #12 AWG

Information on Type T—30 mm Foundry Duty Selector Switches can be found in Square D Catalog #9001CT0001.

**Minimum Centerline Spacing for Type K & SK Control Units (see drawing below)**

Legend Plate	Operator	Centerline Spacing (Inches)					
		A	B	C	D	E	F
<b>Legend Plate Orientation Position #1</b>							
KN2 KN5	Standard Push Button	1.75	1.31	1.44	2.25	1.69	0.88
	1 <sup>3</sup> / <sub>8</sub> " Dia. Mushroom	1.75	1.31	1.44	2.25	1.69	0.88
	2 <sup>1</sup> / <sub>4</sub> " Dia. Mushroom Selector Switch Knobs	2.25	1.31	1.44	2.25	2.25	1.12
KN3	Standard Push Button	2.00	1.31	1.44	2.25	1.75	0.88
	1 <sup>3</sup> / <sub>8</sub> " Dia. Mushroom	2.00	1.31	1.44	2.25	1.75	0.88
	2 <sup>1</sup> / <sub>4</sub> " Dia. Mushroom Selector Switch Knobs	2.25	1.31	1.44	2.25	2.25	1.12
KN4	Standard Push Button	1.94	1.31	1.44	2.25	1.62	0.88
	1 <sup>3</sup> / <sub>8</sub> " Dia. Mushroom	1.94	1.31	1.44	2.25	1.62	0.88
	2 <sup>1</sup> / <sub>4</sub> " Dia. Mushroom Selector Switch Knobs	2.25	1.31	1.44	2.25	2.25	1.12
KN6	Standard Push Button	2.38	1.62	1.44	2.25	2.25	1.12
	1 <sup>3</sup> / <sub>8</sub> " Dia. Mushroom	2.38	1.62	1.44	2.25	2.25	1.12
	2 <sup>1</sup> / <sub>4</sub> " Dia. Mushroom Selector Switch Knobs	2.38	1.62	1.44	2.25	2.25	1.12
<b>Legend Plate Orientation Position #2</b>							
KN2 KN5	Standard Push Button	1.62	1.31	1.44	2.25	1.75	0.88
	1 <sup>3</sup> / <sub>8</sub> " Dia. Mushroom	1.62	1.31	1.44	2.25	1.75	0.88
	2 <sup>1</sup> / <sub>4</sub> " Dia. Mushroom Selector Switch Knobs	2.25	1.31	1.44	2.25	2.25	1.12
KN3	Standard Push Button	1.75	1.31	1.44	2.25	2.00	0.88
	1 <sup>3</sup> / <sub>8</sub> " Dia. Mushroom	1.75	1.31	1.44	2.25	2.00	0.88
	2 <sup>1</sup> / <sub>4</sub> " Dia. Mushroom Selector Switch Knobs	2.25	1.31	1.44	2.25	2.25	1.12
KN4	Standard Push Button	1.62	1.31	1.44	2.25	1.94	1.00
	1 <sup>3</sup> / <sub>8</sub> " Dia. Mushroom	1.62	1.31	1.44	2.25	1.94	1.00
	2 <sup>1</sup> / <sub>4</sub> " Dia. Mushroom Selector Switch Knobs	2.25	1.31	1.44	2.25	2.25	1.12
KN6	Standard Push Button	2.25	1.31	1.62	2.38	2.38	0.88
	1 <sup>3</sup> / <sub>8</sub> " Dia. Mushroom	2.25	1.31	1.62	2.38	2.38	0.88
	2 <sup>1</sup> / <sub>4</sub> " Dia. Mushroom Selector Switch Knobs	2.25	1.31	1.62	2.38	2.38	1.12

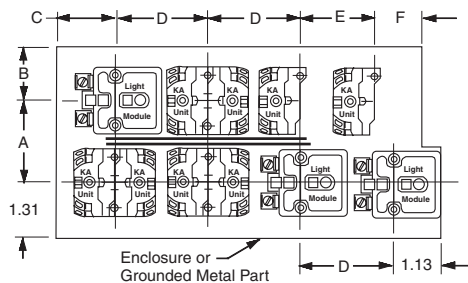

D30052-287

For additional information, reference Catalog #9001CT0001.

# Push Buttons—Class 9001 Type K—30 mm

## Heavy Duty Operators



www.SquareD.com

For the most up-to-date information

17 PUSH BUTTONS AND OPERATOR INTERFACE

### Non-Illuminated Momentary Push Button Operators—UL Types 4, 13/NEMA 4, 13



For use in hazardous locations—See page 17-79.

Contact blocks and legend plate not included unless otherwise noted.

Description		Color	Operator with 1 N.O. and 1 N.C. Contact (KA1)	Price	Operator with 1 N.O. Contact (KA2)	Operator with 1 N.C. Contact (KA3)	Price	Operator Only with No Contacts	Price
 9001KR1B	Full Guard	Black	KR1BH13	\$54.00	KR1BH5	KR1BH6	\$39.90	KR1B	\$25.70
		Red	KR1RH13	54.00	KR1RH5	KR1RH6	39.90	KR1R	25.70
		Green	KR1GH13	54.00	KR1GH5	KR1GH6	39.90	KR1G	25.70
		Universal ▲	KR1UH13	54.00	KR1UH5	KR1UH6	39.90	KR1U	25.70
		Other ■	KR1■H13	54.00	KR1■H5	KR1■H6	39.90	KR1■	25.70
 9001KR3B	No Guard	Black	KR3BH13	54.00	KR3BH5	KR3BH6	39.90	KR3B	25.70
		Red	KR3RH13	54.00	KR3RH5	KR3RH6	39.90	KR3R	25.70
		Green	KR3GH13	54.00	KR3GH5	KR3GH6	39.90	KR3G	25.70
		Universal ▲	KR3UH13	54.00	KR3UH5	KR3UH6	39.90	KR3U	25.70
		Other ■	KR3■H13	54.00	KR3■H5	KR3■H6	39.90	KR3■	25.70
 9001KR2B	Extended Guard	Black	KR2BH13	54.00	KR2BH5	KR2BH6	39.90	KR2B	25.70
		Red	KR2RH13	54.00	KR2RH5	KR2RH6	39.90	KR2R	25.70
		Green	KR2GH13	54.00	KR2GH5	KR2GH6	39.90	KR2G	25.70
		Universal ▲	KR2UH13	54.00	KR2UH5	KR2UH6	39.90	KR2U	25.70
		Other■	KR2■H13	54.00	KR2■H5	KR2■H6	39.90	KR2■	25.70

▲ The universal push button operators contain one each of the following color inserts: black, red, green, yellow, orange, blue and white.

■ See table below for color code.

Description		Color	Operator with 1 N.O. and 1 N.C. Contact (KA1)	Price	Operator with 1 N.O. Contact (KA2)	Operator with 1 N.C. Contact (KA3)	Price	Operator Only with No Contacts	Price		
 9001KR4B	1 3/8" Diameter Mushroom Button	<b>Snap-In Mushroom Button</b>									
		Black	KR4BH13	\$83.00	KR4BH5	KR4BH6	\$68.00	KR4B	\$54.00		
		Red	KR4RH13	83.00	KR4RH5	KR4RH6	68.00	KR4R	54.00		
		Red♦	KR4R05H13	86.00	KR4R05H5	KR4R05H6	72.00	KR4R05	57.00		
		Green	KR4GH13	83.00	KR4GH5	KR4GH6	68.00	KR4G	54.00		
		Other★	KR4★H13	83.00	KR4★H5	KR4★H6	68.00	KR4★	54.00		
		<b>Screw-On Mushroom Button With Set Screw Security</b>									
		Black	KR24BH13	83.00	KR24BH5	KR24BH6	68.00	KR24B	54.00		
		Red	KR24RH13	83.00	KR24RH5	KR24RH6	68.00	KR24R	54.00		
		Green	KR24GH13	83.00	KR24GH5	KR24GH6	68.00	KR24G	54.00		
		Other★	KR24★H13	83.00	KR24★H5	KR24★H6	68.00	KR24★	54.00		
		 9001KR5B	2 1/4" Diameter Mushroom Button	<b>Snap-In Mushroom Button</b>							
				Black	KR5BH13	83.00	KR5BH5	KR5BH6	68.00	KR5B	54.00
				Red	KR5RH13	83.00	KR5RH5	KR5RH6	68.00	KR5R	54.00
				Red♦	KR5R05H13	86.00	KR5R05H5	KR5R05H6	72.00	KR5R05	57.00
Green	KR5GH13			83.00	KR5GH5	KR5GH6	68.00	KR5G	54.00		
Other★	KR5★H13			83.00	KR5★H5	KR5★H6	68.00	KR5★	54.00		
<b>Screw-On Mushroom Button With Set Screw Security</b>											
Black	KR25BH13			83.00	KR25BH5	KR25BH6	68.00	KR25B	54.00		
Red	KR25RH13			83.00	KR25RH5	KR25RH6	68.00	KR25R	54.00		
Green	KR25GH13			83.00	KR25GH5	KR25GH6	68.00	KR25G	54.00		
Other★	KR25★H13			83.00	KR25★H5	KR25★H6	68.00	KR25★	54.00		

♦ Knob has the words "Emergency Stop" in raised letters highlighted in white for readability.

★ See table below for color code.

Color	■ KR1, 2, 3 Place Color Code in Type Number	★ KR4, 5, 24, 25 Place Color Code in Type Number
Blue	L	L
Yellow	Y	Y
White	W	...
Orange	S	S
Gray	E	...

Light Modules .....	page 17-77
Contact Blocks .....	page 17-78
H Contact Block Assembly Codes .....	page 17-80
Legend Plates .....	page 17-81
Accessories .....	page 17-83
Replacement Parts .....	page 17-86

For additional information, reference Catalog #9001CT0001.

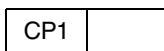



Discount  
Schedule





**Illuminated and Non-Illuminated Multifunction Operators**

Meets UL Type 13/NEMA 13 and UL Type 6/NEMA 6, which UL and NEMA consider an equivalent to UL Type 4/NEMA 4.  
For use in hazardous locations—See page 17-79.  
Legend plate and contact blocks not included unless otherwise noted.

	Description	Color	With 2 N.O. Contacts (2 KA2)	With 1 N.O. & 1 N.C. Contact (KA2, KA3)	Price	Without Contacts ☆	Price
 <b>9001KR7U</b>	Momentary Dual Function	Universal ▲ Green-Red Other ■	KR6UH7 KR6GRH37 KR6■H7	KR6UH37 KR6GRH37 KR6■H37	\$ 83. 83. 83.	KR6U KR6GR KR6■	\$ 54. 54. 54.
	Momentary Interlocked Dual Function	Universal▲ Green-Red Other ■	KR67UH7 KR6GRH37 KR67■H7	KR67UH37 KR6GRH37 KR67■H37	111. 111. 111.	KR67U KR67GR KR67■	83. 83. 83.
	Maintained Interlocked Dual Function	Universal ▲ Green-Red Other ■	KR7UH7 KR6GRH37 KR7■H7	KR7UH37 KR6GRH37 KR7■H37	111. 111. 111.	KR7U KR7GR KR7■	83. 83. 83.
 <b>9001KR11U</b>	<b>Description</b>	<b>Color</b>		<b>Contacts ▽ (KA1)</b>	<b>Price</b>	<b>Without Contacts ☆</b>	<b>Price</b>
	Both Buttons Maintained Interlocked Assembly	Universal ◆ Other ★	...	KR11UH1 KR11★H1	108. 108.	KR11U KR11★	80. 80.
	One Button Momentary One Button Maintained Interlocked Assembly	Universal ◆ Other★	...	KR12UH1H1 KR12★H1H1	165. 165.	KR12U KR12★	108. 108.

- ▲ Universal for KR6, KR67, KR7 includes 2 inserts each of black, red and green.
- Choose one color for each button. R = red, G = green, B = Black.  
**EXAMPLE: A KR6 with left red and right black = KR6RB**
- ◆ Universal for KR11, KR12 includes 2 each of black, red, green, yellow, orange, blue, white.
- ★ Choose one color for each button from table and insert color code in type number.  
**EXAMPLE: A KR11 with top button gray and bottom button orange = KR11ES**

	Description *	Color	With 2 N.C. Contacts (1 KA3, 1 KA5)	With 1 N.O. & 1 N.C. Contact (1 KA1)	Price	Without Contacts ☆	Price
 <b>KR9R94H13 Set Screw Style</b>	3 Position Non-Illuminated Momentary Pull Maintained Neutral Momentary Push	Red Green Other ▼	KR8RH25 KR8GH25 KR8▼H25	... ... ...	\$ 86. 86. 86.	KR8R KR8G KR8▼	\$57. 57. 57.
	2 Position Non-Illuminated Maintained Pull Maintained Push	Red ◉ Green Other ▼	... ... ...	KR9RH13 KR9GH13 KR9▼H13	114. 114. 114.	KR9R KR9G KR9▼	86. 86. 86.
	Set Screw Style	Red	...	KR9R94H13	117.	KR9R94	89.

	Description *	Voltage	With Red Knob and 2 N.C. Contacts (1 KA3, 1 KA5)	With Other Color Knob and 2 N.C. Contacts (1 KA3, 1 KA5)	Price	With Other Color Knob Without Contacts ☆	Price
 <b>9001KR9P1</b> 1 3/8" Dia. Knob For 1 3/8" or 2 1/4" Dia. Knob * Includes Type KN379 Legend Plate Marked Pull To Start Push To Stop	3 Position Illuminated Momentary Pull Maintained Neutral Momentary Push	110-120 V, 50-60 Hz Other—Transformer, LED, Flashing ◻ Other—Full Voltage, Resistor, Neon ◊	KR8P1RH25 KR8PΔRH25 KR8PΔRH25	KR8P1▼H25 KR8PΔ▼H25 KR8PΔ▼H25	\$162. 162. 143.	KR8P1▼ KR8PΔ▼ KR8PΔ▼	\$134. 134. 114.
	<b>Description *</b>	<b>Voltage</b>	<b>With Red ◉ Knob and 1 N.O. &amp; 1 N.C. Contact (KA1)</b>	<b>With Other Color Knob and 1 N.O. &amp; 1 N.C. Contact (KA1)</b>	<b>Price</b>	<b>With Other Color Knob Without Contacts</b>	<b>Price</b>
	2 Position Illuminated Maintained Pull Maintained Push	110-120 V, 50-60 Hz Other—Transformer, LED, Flashing ◻ Other—Full Voltage, Resistor, Neon ◊	KR9P1RH13 KR9PΔRH13 KR9PΔRH13	KR9P1▼H13 KR9PΔ▼H13 KR9PΔ▼H13	\$191. 191. 171.	KR9P1▼ KR9PΔ▼ KR9PΔ▼	\$162. 162. 143.

- ▼ Choose one color from table and insert color code in Type number.  
**EXAMPLE: KR9 with a yellow knob = KR9Y**
- △ Add the voltage assembly code as chosen from table on page 17-77.  
**EXAMPLE: KR8P with a 277 V 50-60 Hz voltage = KR8P8**
- ◻ The knob must be the same color as the LED light module chosen, e.g., for green LED, use green knob.
- ◊ On neon light modules, use clear knobs only.
- ★ These operators can be ordered complete with contact blocks. For maximum block usage, see page 17-80. Add the "H" number chosen from page 17-80 to the end of the operator Type number and add the cost of the "H" number to the operator cost.
- ▽ KR11UH1 has 1 KA1 (1 N.O., 1 N.C.) and KR12UH1H1 has 2 KA1 (2 N.O., 2 N.C.).
- ◉ To obtain a red knob with "Push Emergency Stop" printed on the red knob—substitute "R05" in place of "R" and add \$2.10 to the price.
- \* For 1 3/8" or 2 1/4" Dia. Knob:
  - a) Order Type -20 or -21 knob from page 17-84.
  - b) Order 9001K54 adapter (no charge)—allows Type -20 or -21 knob to fit on push pull operators. Voids UL and NEMA 6 rating.
  - c) Can order assembled operator by adding color code to Type -20 or -21.  
**Example: 9001KR9R would be 9001KR9R20 or 9001KR9R21. No price adder.**

**Other Color Code Selection**

Color	KR6, KR7, KR67	KR11, KR12	KR8, KR9
Black ◊	B	B	B
Red	R	R	R
Green	G	G	G
Blue	...	L	L
Yellow	...	Y	Y
White	...	W	W
Orange ◊	...	S	S
Clear	...	...	C
Amber	...	...	A
Gray	...	E	...

◊ These colors are not available on illuminated push-pull operators.

For additional information, reference Catalog #9001CT0001.

# Push Buttons—Class 9001 Type K—30 mm

## Heavy Duty Operators



www.SquareD.com





For the most up-to-date information

17 PUSH BUTTONS AND OPERATOR INTERFACE

### Illuminated Push Button Operators—UL Types 4, 13/NEMA 4, 13

For use in hazardous locations—See page 17-79.

Legend plate and contact block not included unless otherwise noted.

Description		Voltage and Frequency	Style	With Red Color Cap and 1 N.O. and 1 N.C. Contact (KA1)	With Green Color Cap and 1 N.O. and 1 N.C. Contact (KA1)	Price □	With Other Color Cap Without Contact Block ▲	Price ◇
 9001K1L1	Full Guard Illuminated Push Button Clear Plastic Top	110–120 V, 50–60 Hz	Transformer	K1L1RH13	K1L1GH13	\$140.	K1L1▼	\$111.
		220–240 V, 50–60 Hz	Transformer	K1L7RH13	K1L7GH13	140.	K1L7▼	111.
		24–28 Vac/dc	Full Voltage	K1L35RH13	K1L35GH13	120.	K1L35▼	92.
		For other voltages see Table ■	Transformer or Flashing	K1L■RH13	K1L■GH13	140.	K1L■▼	111.
			Full Voltage	K1L■RH13	K1L■GH13	120.	K1L■▼	92.
Resistor or Neon ◆	K1L■RH13		K1L■GH13	120.	K1L■▼	92.		
LED ★	K1L■RH13	K1L■GH13	140.	K1L■▼	111.			
 9001K3L1	Full Guard Illuminated Push Button Metal Top	110–120 V, 50–60 Hz	Transformer	K3L1RH13	K3L1GH13	140.	K3L1▼	111.
		220–240 V, 50–60 Hz	Transformer	K3L7RH13	K3L7GH13	140.	K3L7▼	111.
		24–28 Vac/dc	Full Voltage	K3L35RH13	K3L35GH13	120.	K3L35▼	92.
		For other voltages see Table ■	Transformer or Flashing	K3L■RH13	K3L■GH13	140.	K3L■▼	111.
			Full Voltage	K3L■RH13	K3L■GH13	120.	K3L■▼	92.
Resistor or Neon ◆	K3L■RH13		K3L■GH13	120.	K3L■▼	92.		
LED ★	K3L■RH13	K3L■GH13	140.	K3L■▼	111.			
 9001K2L1	No Guard Illuminated Push Button	110–120 V, 50–60 Hz	Transformer	K2L1RH13	K2L1GH13	131.	K2L1▼	102.
		220–240 V, 50–60 Hz	Transformer	K2L7RH13	K2L7GH13	131.	K2L7▼	102.
		24–28 Vac/dc	Full Voltage	K2L35RH13	K2L35GH13	111.	K2L35▼	83.
		For other voltages see Table ■	Transformer or Flashing	K2L■RH13	K2L■GH13	131.	K2L■▼	102.
			Full Voltage	K2L■RH13	K2L■GH13	111.	K2L■▼	83.
Resistor or Neon ◆	K2L■RH13		K2L■GH13	111.	K2L■▼	83.		
LED ★	K2L■RH13	K2L■GH13	131.	K2L■▼	102.			
 9001K2LR20	1 3/8 Inch Illuminated Mushroom	110–120 V, 50–60 Hz	Transformer	K2L1R20H13	K2L1G20H13	131.	Order K2L ■▼ Above ▲	
		220–240 V, 50–60 Hz	Transformer	K2L7R20H13	K2L7G20H13	131.		
		24–28 Vac/dc	Full Voltage	K2L35R20H13	K2L35G20H13	111.		
		For other voltages see Table ■	Transformer or Flashing	K2L■R20H13	K2L■G20H13	131.		
			Full Voltage	K2L■R20H13	K2L■G20H13	111.		
Resistor or Neon ◆	K2L■R20H13		K2L■G20H13	111.				
LED ★	K2L■R20H13	K2L■G20H13	131.					
 9001K2LR21	2 1/4 Inch Illuminated Mushroom	110–120 V, 50–60 Hz	Transformer	K2L1R21H13	K2L1G21H13	131.	Order K2L ■▼ Above ▲	
		220–240 V, 50–60 Hz	Transformer	K2L7R21H13	K2L7G21H13	131.		
		24–28 Vac/dc	Full Voltage	K2L35R21H13	K2L35G21H13	111.		
		For other voltages see Table ■	Transformer or Flashing	K2L■R21H13	K2L■G21H13	131.		
			Full Voltage	K2L■R21H13	K2L■G21H13	111.		
Resistor or Neon ◆	K2L■R21H13		K2L■G21H13	111.				
LED ★	K2L■R21H13	K2L■G21H13	131.					

▲ These operators can be ordered complete with contact blocks. For maximum block usage, see page 17-85. Add the "H" number chosen from page 17-80 to the end of the operator type number and add the cost of the "H" number to the operator cost.

■ Add the voltage assembly code as chosen from table on page 17-77.

Example: K2L▲ with 240 Vac/dc = K2L25

◆ On neon light modules, use clear color caps only.

★ The cap must be the same color as the LED light module chosen, e.g., for red LED, use red color cap.

▼ Add the color code as chosen from the color cap table.

Example: K2L25★ with a blue 1 3/8 inch mushroom button = K2L25L20

▲ The only difference between a no guard (K2L▲) operator and mushroom button operator is the color cap.

□ Price includes operator, light module, contact block and color cap.

◇ Price includes operator, light module and color cap.

### Color Caps

Color	Color Codes		
	▼ K1L K2L, K3L	▼ 1 3/8 Inch Mushroom	▼ 2 1/4 Inch Mushroom
Red	R	R20	R21
Green	G	G20	G21
Blue	L	L20	L21
Yellow	Y	Y20	Y21
White	W	W20	W21
Clear	C	C20	C21
Amber	A	A20	A21

Light Modules	page 17-77
Contact Blocks	page 17-78
H Contact Block Assembly Codes	page 17-80
Legend Plates	page 17-81
Accessories	page 17-83
Replacement Parts	page 17-86

For additional information, reference Catalog #9001CT0001.

**Non-Illuminated 2 Position Selector Switch Operators—UL Types 4, 13/NEMA 4, 13**

For use in hazardous locations—See page 17-79.  
Legend plate and contact block not included unless noted.

Contact Block Required				1—Contact Closed 0—Contact Open				
Contact Block Position	Quantity and Type		Mount on Side	Left		Right		
	Left	Right		Left	Right	Left	Right	
<p>Top View</p>	KA1	KA3	KA1 #2	KA3 #2	1	0	0	1
	KA2	KA2		KA2 #2	0	1	1	0
	KA1	KA3	KA1 #1	KA3 #1	1	0	0	1
		KA2		KA2 #1	0	1	1	0
Cam (see page 17-64)				E		D		
Non-Illuminated Operators				Type		Type		Price

**Manual Return**

Operator Only ▲	Type	Type	Price
Without Knob	KS11	KS12	\$ 28.50
With Standard Black Knob	KS11B	KS12B	35.10
With Other Color Knob (See Knob Table) ■	KS11■	KS12■	35.10
Key Operated with E10 Key (Code 1, 2, 3) ♦ ★	KS11K♦	KS12K♦	92.00
With Contact Block(s)			
With Standard Knob			
With 1 KA1 on Side #2	KS11BH13	...	64.00
With 1 KA1 on Side #1	KS11BH1	...	64.00
With 1 KA1 on Side #1 and 1 KA1 on Side #2	KS11BH2	...	92.00

**Spring Return from Left**

Operator Only a	Type	Type	Price
Without Knob	KS25	...	47.60
With Standard Black Knob	KS25B	...	54.00
With Other Color Knob (See Knob Table) b	KS25■	...	54.00
Key Operated with E10 Key (Code 2 only) d	KS25K2	...	111.00

**Spring Return From Right**

Operator Only a	Type	Type	Price
Without Knob	...	KS34	47.60
With Standard Black Knob	...	KS34B	54.00
With Other Color Knob (See Knob Table) b	...	KS34■	54.00
Key Operated with E10 Key (Code 1 Only) d	...	KS34K1	111.00

- ▲ These operators can be ordered complete with contact blocks. For maximum block usage, see page 17-85. Add the "H" number chosen from page 17-80 to the end of the operator type number and add the cost of the "H" number to the operator cost.
- Add the color code as chosen from knob color table at right.
- ♦ Example: KS11■ with a green gloved-hand knob = KS11FG
- ♦ Add the key withdrawal code from key withdrawal code table below.
- ♦ Example: KS11K♦ with key withdrawal in the right position only = KS11K2
- ★ All key operated devices come standard with Square D key no. E10 (key only part no. is 2941101100, \$6.60 per key). Other key changes are available at no extra cost. Contact your nearest Square D/Schneider Electric sales office.

**♦ Key Withdrawal Code**

Code	Position
1	Left Only
2	Right Only
3	Left and Right

**Selector Switch Knobs**

Color	Standard Knob		Gloved-Hand Knob		Coin Operated		Price
	Knob Code	Type	Knob Code	Type	Knob Code	Type	
Black	B	B11	FB	B25	TB	B18	\$6.60
Red	R	R8	FR	R24	TR	R16	
Green	G	G8	FG	G24	TG	G16	
Yellow	Y	Y8	FY	Y24	TY	Y16	
Orange	S	S11	FS	S25	...	...	
Blue	L	L8	FL	L24	TL	L16	
White	W	W8	FW	W24	...	...	
Amber	A	A8	FA	A24	...	...	
Clear	C	C8	FC	C24	TC	C16	

For additional information, reference Catalog #9001CT0001.

# Push Buttons—Class 9001 Type K—30 mm

## Heavy Duty Selector Switches

### Illuminated 2 Position Selector Switch Operators – UL Types 4, 13/NEMA 4, 13

For use in hazardous locations – See page 17-79.  
Legend plate and contact block not included unless noted.

Contact Block Required				1 — Contact Closed 0 — Contact Open				
Contact Block Position	Quantity and Type		Mount on Side		Left	Right	Left	Right
	<p>Top View</p>	KA1 	KA3 	KA1 #2	KA3 #2	1	0	0
		KA2 		KA2 #2	0	1	1	0
KA1 		KA3 	KA1 #1	KA3 #1	1	0	0	1
		KA2 		KA2 #1	0	1	1	0
Cam (see page 17-64)				E		D		
Illuminated Operators				Type		Type		Price
Manual Return ▲ Without Knob, 110–120 V 50–60 Hz Transformer With Standard Red Knob, 110–120 V 50–60 Hz Transformer Without Knob and Other Voltage Transformer, Flashing or LED ★ Without Knob, Full Voltage Neon or Resistor ▼ With Other Color Knob and Transformer, Flashing or LED ★ With Other Color Knob, Full Voltage Neon or Resistor ▼				K11J1 K11J1R K11J■ K11J◆ K11J◆		K12J1 K12J1R K12J■ K12J◆ K12J◆		\$105. 111. 105. 86. 111. 92.
Spring Return from Left ▲ Without Knob, 110–120 V 50–60 Hz Transformer With Standard Red Knob, 110–120 V 50–60 Hz Transformer Without Knob and Other Voltage Transformer, Flashing or LED ★ Without Knob, Full Voltage Neon or Resistor ▼ With Other Color Knob and Transformer, Flashing or LED ★ With Other Color Knob, Full Voltage Neon or Resistor ▼				K25J1 K25J1R K25J■ K25J◆ K25J◆		... ... ... ... ...		123. 131. 123. 105. 131. 111.
Spring Return From Right ▲ Without Knob, 110–120 V 50–60 Hz Transformer With Standard Red Knob, 110–120 V 50–60 Hz Transformer Without Knob and Other Voltage Transformer, Flashing or LED ★ Without Knob, Full Voltage Neon or Resistor ▼ With Other Color Knob and Transformer, Flashing or LED ★ With Other Color Knob, Full Voltage Neon or Resistor ▼				... ... ... ... ... ...		K34J1 K34J1R K34J■ K34J◆ K34J◆		123. 131. 123. 105. 131. 111.

- ▲ These operators can be ordered complete with contact blocks. For maximum block usage, see page 17-85. Add the "H" number chosen from page 17-80 to the end of the operator type number and add the cost of the "H" number to the operator cost.
- Add the voltage assembly code as chosen from the table on page 17-77.  
Example: K25J■ with 60 Vac/dc = K25J37.
- ◆ Add the color code as chosen from the knob color table below.  
Example: K25J35◆ with a green knob = K25J35G.
- ★ The knob must be the same color as the LED light module chosen, e.g., for red LED, use red knob.
- ▼ On neon light modules, use clear knobs only.

### Selector Switch Knobs

Standard Knob		Gloved-Hand Knob		Coin Operated		Price
Color	◆ Knob Code	◆ Knob Code	Type	◆ Knob Code	Type	
Red	R	FR	R24	TR	R16	\$6.60
Green	G	FG	G24	TG	G16	
Yellow	Y	FY	Y24	TY	Y16	
Blue	L	FL	L24	TL	L16	
White	W	FW	W24	...	...	
Amber	A	FA	A24	...	...	
Clear	C	FC	C24	TC	C16	

### Two Color Selector Switch

Used to indicate red in left position and green in right position on illuminated operators.

Knob	Factory Assembled Form Number Δ	Price Adder
Standard	Y178	\$28.50
Gloved-Hand	Y1781	28.50

Δ Add form number to standard Type number, e.g., Type K11J1 Form Y178.

Light Modules .....	page 17-77
Contact Blocks .....	page 17-78
H Contact Block Assembly Codes .....	page 17-80
Legend Plates .....	page 17-81
Accessories .....	page 17-83
Replacement Parts .....	page 17-86

For additional information, reference Catalog #9001CT0001.

**Non-Illuminated 3 Position Selector Switch Operators—UL Types 4, 13/NEMA 4, 13**

For use in hazardous locations—See page 17-79.  
Legend plate and contact block not included unless noted

CONTACT BLOCK REQUIRED				1—Contact Closed 0—Contact Open										
Contact Block Position	Quantity and Type	Mount on Side	Center		Center		Center		Center		Center		Center	
			Left	Right	Left	Right	Left	Right	Left	Right	Left	Right	Left	Right
<p><b>Top View</b></p>	KA1	KA3 #2	1	0	0	1	0	0	1	1	0	0	1	0
	KA2	KA2 #2	0	1	1	0	0	1	0	0	1	0	1	0
	KA1	KA3 #1	0	0	1	1	0	0	1	1	0	0	1	0
	KA2	KA2 #1	1	1	0	0	0	1	0	0	1	0	0	1
<b>Cam (see page 17-64)</b>				<b>B</b>	<b>C</b>	<b>D</b>	<b>E</b>	<b>F</b>	<b>G</b>	<b>J</b>	<b>L</b>	<b>M</b>		
<b>Non-Illuminated Operators</b>				<b>Type</b>	<b>Type</b>	<b>Type</b>	<b>Type</b>	<b>Type</b>	<b>Type</b>	<b>Type</b>	<b>Type</b>	<b>Type</b>	<b>Price</b>	
Manual Return Operator Only ▲														
Without Knob				KS42	KS43	KS44	KS45	KS46	KS47	KS49	KS401	KS402	\$28.50	
With Standard Black Knob				KS42B	KS43B	KS44B	KS45B	KS46B	KS47B	KS49B	KS401B	KS402B	35.10	
With Other Color Knob (See Knob Table) ■				KS42■	KS43■	KS44■	KS45■	KS46■	KS47■	KS49■	KS401■	KS402■	35.10	
Key Operated with E10 Key (Code 4 through 10) ◆★				KS42K◆	KS43K◆	KS44K◆	KS45K◆	KS46K◆	KS47K◆	KS49K◆	KS401K◆	KS402K◆	92.00	
With Contact Block(s)														
With Standard Black Knob (For Other Colors, Replace B in Type Number with Color Code from table.)														
With 1 KA1 on side #2 (H13)				KS42BH13	KS43BH13	KS44BH13	KS45BH13	KS46BH13	KS47BH13	KS49BH13	KS401BH13	KS402BH13	64.00	
With 1 KA1 on side #1 (H1)				KS42BH1	KS43BH1	KS44BH1	KS45BH1	KS46BH1	KS47BH1	KS49BH1	KS401BH1	KS402BH1	64.00	
With 1 KA1 on side #1 and 1 KA1 on side #2 (H2)				KS42BH2	KS43BH2	KS44BH2	KS45BH2	KS46BH2	KS47BH2	KS49BH2	KS401BH2	KS402BH2	92.00	
Spring Return from Left to Center Operator Only ▲														
Without Knob				KS62	KS63	KS64	KS65	KS66	KS67	KS69	KS601	KS602	47.60	
With Standard Black Knob				KS62B	KS63B	KS64B	KS65B	KS66B	KS67B	KS69B	KS601B	KS602B	54.00	
With Other Color Knob (See Knob Table) ■				KS62■	KS63■	KS64■	KS65■	KS66■	KS67■	KS69■	KS601■	KS602■	54.00	
Key Operated with E10 Key (Code 5, 6 or 9 only) ◆★				KS62K◆	KS63K◆	KS64K◆	KS65K◆	KS66K◆	KS67K◆	KS69K◆	KS601K◆	KS602K◆	111.00	
Spring Return from Right to Center Operator Only ▲														
Without Knob				KS72	KS73	KS74	KS75	KS76	KS77	KS79	KS701	KS702	47.60	
With Standard Black Knob				KS72B	KS73B	KS74B	KS75B	KS76B	KS77B	KS79B	KS701B	KS702B	54.00	
With Other Color Knob (See Knob Table) ■				KS72■	KS73■	KS74■	KS75■	KS76■	KS77■	KS79■	KS701■	KS702■	54.00	
Key Operated with E10 Key (Code 4, 5 or 7 Only) ◆★				KS72K◆	KS73K◆	KS74K◆	KS75K◆	KS76K◆	KS77K◆	KS79K◆	KS701K◆	KS702K◆	111.00	
Spring Return Both Sides to Center Operator Only ▲														
Without Knob				KS52	KS53	KS54	KS55	KS56	KS57	KS59	KS501	KS502	47.60	
With Standard Black Knob				KS52B	KS53B	KS54B	KS55B	KS56B	KS57B	KS59B	KS501B	KS502B	54.00	
With Other Color Knob (See Knob Table) ■				KS52■	KS53■	KS54■	KS55■	KS56■	KS57■	KS59■	KS501■	KS502■	54.00	
Key Operated with E10 Key (Code 5 Only) ★				KS52K5	KS53K5	KS54K5	KS55K5	KS56K5	KS57K5	KS59K5	KS501K5	KS502K5	111.00	

- ▲ These operators can be ordered complete with contact blocks. For maximum block usage, see page 17-85. Add the "H" number chosen from page 17-80 to the end of the operator type number and add the cost of the "H" number to the operator cost.
- Add the color code as chosen from knob color table at right.
- ◆ **EXAMPLE: KS43■ with a green gloved-hand knob = KS43FG**
- ★ Add the key withdrawal code from key withdrawal code table below.
- ◆ **EXAMPLE: KS43K◆ with key withdrawal in the right position only = KS43K6**
- ★ All key operated devices come standard with Square D key no. E10 (key only part no. is 2941101100, \$6.60 per key). Other key changes are available at no extra cost. Contact your nearest Square D/Schneider Electric sales office.

**◆ Key Withdrawal Codes**

Code	Position
4	Left Only
5	Center Only
6	Right Only
7	Left and Center
8	Left and Right
9	Center and Right
10	Left, Center and Right

**Selector Switch Knobs**

Standard Knob		Gloved-Hand Knob		Coin Operated		Price	
Color	Knob Code	Type	Knob Code	Type	Knob Code	Type	Price
Black	B	B11	FB	B25	TB	B18	\$6.60
Red	R	R8	FR	R24	TR	R16	
Green	G	G8	FG	G24	TG	G16	
Yellow	Y	Y8	FY	Y24	TY	Y16	
Orange	S	S11	FS	S25	...	...	
Blue	L	L8	FL	L24	TL	L16	
White	W	W8	FW	W24	...	...	
Amber	A	A8	FA	A24	...	...	
Clear	C	C8	FC	C24	TC	C16	

For additional information, reference Catalog #9001CT0001.

# Push Buttons—Class 9001 Type K—30 mm Selector Switches

## Illuminated 3 Position Selector Switch Operators

For use in hazardous locations—See page 17-79.  
Legend plate and contact block not included unless noted.

CONTACT BLOCK REQUIRED				1 — Contact Closed					0 — Contact Open							
Contact Block Position	Quantity and Type	Mount on Side	Center		Center		Center		Center		Center		Center			
			Left	Right	Left	Right	Left	Right	Left	Right	Left	Right	Left	Right		
<p>Top View</p>	KA1 or KA2	KA3 #2	1	0	0	1	0	0	1	0	0	1	0	0		
			0	1	1	0	0	1	0	1	0	0	1	0	1	0
	KA1 or KA2	KA3 #1	0	0	1	1	0	0	1	1	0	0	1	0	0	1
			1	1	0	0	0	1	0	1	0	0	1	0	0	1
Cam (see page 17-64)			B	C	D	E	F	G	J	L	M					
Illuminated Operators			Type	Type	Type	Type	Type	Type	Type	Type	Type	Type	Type	Price		
Manual Return ▲ Without Knob, 110–120 V 50–60 Hz Transformer			K42J1	K43J1	K44J1	K45J1	K46J1	K47J1	K49J1	K401J1	K402J1	K402J1	\$105.			
With Standard Red Knob, 110–120 V 50–60 Hz Transformer			K42J1R	K43J1R	K44J1R	K45J1R	K46J1R	K47J1R	K49J1R	K401J1R	K402J1R	K402J1R	111.			
Without Knob and Other Voltage Transformer, Flashing or LED ★			K42J	K43J	K44J	K45J	K46J	K47J	K49J	K401J	K402J	K402J	105.			
Without Knob, Full Voltage Neon or Resistor ▼			K42J	K43J	K44J	K45J	K46J	K47J	K49J	K401J	K402J	K402J	86.			
With Other Color Knob and Transformer, Flashing or LED ★			K42J◆	K43J◆	K44J◆	K45J◆	K46J◆	K47J◆	K49J◆	K401J◆	K402J◆	K402J◆	111.			
With Other Color Knob, Full Voltage Neon or Resistor ▼			K42J◆	K43J◆	K44J◆	K45J◆	K46J◆	K47J◆	K49J◆	K401J◆	K402J◆	K402J◆	92.			
Spring Return Left To Center ▲ Without Knob, 110–120 V 50–60 Hz Transformer			K62J1	K63J1	K64J1	K65J1	K66J1	K67J1	K69J1	K601J1	K602J1	K602J1	123.			
With Standard Red Knob, 110–120 V 50–60 Hz Transformer			K62J1R	K63J1R	K64J1R	K65J1R	K66J1R	K67J1R	K69J1R	K601J1R	K602J1R	K602J1R	131.			
Without Knob and Other Voltage Transformer, Flashing or LED ★			K62J	K63J	K64J	K65J	K66J	K67J	K69J	K601J	K602J	K602J	123.			
Without Knob, Full Voltage Neon or Resistor ▼			K62J	K63J	K64J	K65J	K66J	K67J	K69J	K601J	K602J	K602J	105.			
With Other Color Knob and Transformer, Flashing or LED ★			K62J◆	K63J◆	K64J◆	K65J◆	K66J◆	K67J◆	K69J◆	K601J◆	K602J◆	K602J◆	131.			
With Other Color Knob, Full Voltage Neon or Resistor ▼			K62J◆	K63J◆	K64J◆	K65J◆	K66J◆	K67J◆	K69J◆	K601J◆	K602J◆	K602J◆	111.			
Spring Return Right To Center ▲ Without Knob, 110–120 V 50–60 Hz Transformer			K72J1	K73J1	K74J1	K75J1	K76J1	K77J1	K79J1	K701J1	K702J1	K702J1	123.			
With Standard Red Knob, 110–120 V 50–60 Hz Transformer			K72J1R	K73J1R	K74J1R	K75J1R	K76J1R	K77J1R	K79J1R	K701J1R	K702J1R	K702J1R	131.			
Without Knob and Other Voltage Transformer, Flashing or LED ★			K72J	K73J	K74J	K75J	K76J	K77J	K79J	K701J	K702J	K702J	123.			
Without Knob, Full Voltage Neon or Resistor ▼			K72J	K73J	K74J	K75J	K76J	K77J	K79J	K701J	K702J	K702J	105.			
With Other Color Knob and Transformer, Flashing or LED ★			K72J◆	K73J◆	K74J◆	K75J◆	K76J◆	K77J◆	K79J◆	K701J◆	K702J◆	K702J◆	131.			
With Other Color Knob, Full Voltage Neon or Resistor ▼			K72J◆	K73J◆	K74J◆	K75J◆	K76J◆	K77J◆	K79J◆	K701J◆	K702J◆	K702J◆	111.			
Spring Return Both Sides To Center ▲ Without Knob, 110–120 V 50–60 Hz Transformer			K52J1	K53J1	K54J1	K55J1	K56J1	K57J1	K59J1	K501J1	K502J1	K502J1	123.			
With Standard Red Knob, 110–120 V 50–60 Hz Transformer			K52J1R	K53J1R	K54J1R	K55J1R	K56J1R	K57J1R	K59J1R	K501J1R	K502J1R	K502J1R	131.			
Without Knob and Other Voltage Transformer, Flashing or LED ★			K52J	K53J	K54J	K55J	K56J	K57J	K59J	K501J	K502J	K502J	123.			
Without Knob, Full Voltage Neon or Resistor ▼			K52J	K53J	K54J	K55J	K56J	K57J	K59J	K501J	K502J	K502J	105.			
With Other Color Knob and Transformer, Flashing or LED ★			K52J◆	K53J◆	K54J◆	K55J◆	K56J◆	K57J◆	K59J◆	K501J◆	K502J◆	K502J◆	131.			
With Other Color Knob, Full Voltage Neon or Resistor ▼			K52J◆	K53J◆	K54J◆	K55J◆	K56J◆	K57J◆	K59J◆	K501J◆	K502J◆	K502J◆	111.			

- ▲ These operators can be ordered complete with contact blocks. For maximum block usage, see page 17-85. Add the "H" number chosen from page 17-90 to the end of the operator type number and add the cost of the "H" number to the operator cost.
- ★ Add the voltage assembly code as chosen from table on page 17-77.  
**EXAMPLE: K43J with 60 Vac/dc = K43J37**
- ◆ Add the color code as chosen from knob color table below.  
**EXAMPLE: K43J35 with a green knob = K43J35G**
- ★ The knob must be the same color as the LED light module chosen, e.g., for red LED, use red knob.
- ▼ On neon light modules, use clear knobs only.

## Selector Switch Knobs

Standard Knob		Gloved-Hand Knob		Coin Operated		Price
Color	Knob Code	Knob Code	Type	Knob Code	Type	
Black Δ	B	B11	B25	TB	B18	\$6.60
Red	R	R8	FR	TR	R16	
Green	G	G8	FG	TG	G16	
Yellow	Y	Y8	FY	TY	Y16	
Orange Δ	S	S11	FS	TS	...	
Blue	L	L8	FL	TL	L16	
White	W	W8	FW	...	...	
Amber	A	A8	FA	...	...	
Clear	C	C8	FC	TC	C16	

Δ Non-Illuminated only.

Light Modules ..... page 17-77  
 Contact Blocks ..... page 17-78  
 H Contact Block Assembly Codes ..... page 17-80  
 Legend Plates ..... page 17-81  
 Accessories ..... page 17-83  
 Replacement Parts ..... page 17-86

For additional information, reference Catalog #9001CT0001.

**Non-Illuminated and Illuminated 4 Position Selector Switch Operators**

For use in hazardous locations—See page 17-79. UL Types 4, 13/NEMA 4, 13  
Legend plate and contact block not included unless noted.

CONTACT BLOCK REQUIRED				1—Contact Closed 0—Contact Open		
Contact Block Position	Quantity and Type		Mount on Side			
<p>Top View</p>	KA1 	KA3 	KA1 #2	KA3 #2		
		KA2 		KA2 #2	0 0 1 0	
	KA1 	KA3 	KA1 #1	KA3 #1	0 0 0 1	
		KA2 		KA2 #1	0 1 0 0	
<b>Non-Illuminated Operators</b>				<b>Cam</b> (see page 17-64)	<b>Type</b>	<b>Price</b>
Manual Return ▲ Operator Only ▲ Without Knob With Standard Black Knob With Other Color Knob (See Knob Table) ■ Key Operated with E10 Key (Codes 11, 12, 13, 14, 15) ◆★				H H H H	KS88 KS88B KS88■ KS88K◆	\$28.50 35.10 35.10 92.00
Spring Return From Left—Spring Return From Right— Maintained in the Two Mid Positions Operator Only ▲ Without Knob With Standard Black Knob With Other Color Knob (See Knob Table) ■				H H	KS89 KS89B KS89■	47.60 54.00 54.00
<b>Illuminated Operators</b>						
Manual Return ▲ Without Knob, 110–120 V 50–60 Hz Transformer With Standard Red Knob, 110–120 V 50–60 Hz Transformer Without Knob and With Other Voltage Transformer, Flashing or LED △ Without Knob, Full Voltage Neon or Resistor □ With Other Color Knob and Transformer, Flashing or LED △ With Other Color Knob, Full Voltage Neon or Resistor □				H H H H H H	K88J1 K88J1R K88J▼ K88J▼ K88J▼■ K88J▼■	105.00 111.00 105.00 86.00 111.00 92.00
Spring Return From Left—Spring Return From Right— Maintained in the Two Mid Positions Without Knob, 110–120 V 50–60 Hz Transformer With Standard Red Knob, 110–120 V 50–60 Hz Transformer Without Knob and With Other Voltages Transformer, Flashing or LED △ Without Knob, Full Voltage Neon or Resistor □ With Other Color Knob and Transformer, Flashing or LED △ With Other Color Knob, Full Voltage Neon or Resistor □				H H H H H H	K89J1 K89J1R K89J▼ K89J▼ K89J▼■ K89J▼■	123.00 131.00 123.00 105.00 131.00 111.00

- ▲ These operators can be ordered complete with contact blocks. For maximum block usage, see page 17-85. Add the "H" number chosen from page 17-80 to the end of the operator type number and add the cost of the "H" number to the operator cost.
- Add the color code as chosen from knob color table.  
**EXAMPLE: KS88■ with a green gloved-hand knob = KS88FG.**
- ◆ Add the key withdrawal code from key withdrawal code table.  
**EXAMPLE: KS88K◆ with key withdrawal in the right position only = KS88K12.**
- ★ All key operated devices come standard with Square D key number E10 (key only part no. is 2941101100, \$6.60 per key). Other key changes are available at no extra cost. Contact your nearest Square D/Schneider Electric sales office.
- ▼ Add the voltage assembly code as chosen from table on page 17-77.  
**EXAMPLE: K88J▼ with 60 Vac/dc = K88J37**
- △ The knob must be the same color as the LED light module chosen, e.g., for red LED, use red knob.
- On neon light modules, use clear knobs only.

◆ **Key Withdrawal Code**

Code	Position
11	1 and 4
12	4 only
13	1 only
14	1, 2, 3 and 4
15	2, 3 and 4

**Selector Switch Knobs**

Standard Knob		Gloved-Hand Knob		Coin Operated		Price	
Color	Knob Code	Type	Knob Code	Type	Knob Code		Type
Black ◆	B	B11	FB	B25	TB	B18	\$6.60
Red	R	R8	FR	R24	TR	R16	
Green	G	G8	FG	G24	TG	G16	
Yellow	Y	Y8	FY	Y24	TY	Y16	
Orange ◆	S	S11	FS	S25	...	...	
Blue	L	L8	FL	L24	TL	L16	
White	W	W8	FW	W24	...	...	
Amber	A	A8	FA	A24	...	...	
Clear	C	C8	FC	C24	TC	C16	

◆ Non-Illuminated only.

For additional information, reference Catalog #9001CT0001.

# Push Buttons—Class 9001 Type K, KX, and SK—30 mm

## Selector Switches Guide

Shown below is a simplified method of selecting a selector switch to meet almost any combination of contact sequences.

### Step No. 1

Determine the contact sequence(s) required. Set up a target table like the one shown for the example below.

#### Example:

Contact Sequence	0—contact open    1—contact closed		↙	↑	↘
A	1	0	0		
B	0	1		0	
C	0	0			1

### Step No. 2

Look for a cam type common to all sequences in table 1, 2 or 3. For the example above, table 2 would be used. For the contact sequences A (1 0 0), B (0 1 0) and C (0 0 1) of the example above, cam types F and L are common to all 3 sequences.

### Step No. 3

Next, use the cam type common to all the sequences (if several cam types are common, choose one) to find the operator type number. Go to the proper page number as indicated in the table below:

#### Push Button Types K, SK and KX

Number of Positions	Push Button Line	Page Number
2	Type K, Type SK, Type KX	17-59 to 17-60, 17-71 to 17-72, 17-88
3	Type K, Type SK, Type KX	17-61 to 17-62, 17-73 to 17-74, 17-89
4	Type K, Type SK, Type KX	17-63, 17-75, 17-90

If for the example above a manual return operator with a standard black knob is required and:

The F cam type is chosen, the operator type number is:  
 Type K—Class 9001 Type KS46B (from page 17-61)  
 Type SK—Class 9001 Type SKS46B (from page 17-73)  
 Type KX—Class 9001 Type KXSDFB (from page 17-89)

The L cam type is chosen, the operator type number is:  
 Type K—Class 9001 Type KS401B (from page 17-61)  
 Type SK—Class 9001 Type SKS401B (from page 17-73)  
 Type KX—Class 9001 Type KXSDLB (from page 17-89)

### Step No. 4:

Determine the contact blocks required by using the same table in Step No. 2.

If for the example above:

The F cam type is chosen:  
 Use a 9001KA3 mounted on side no. 2 for sequence A (1 0 0).  
 Use a 9001KA3 mounted on side no. 1 for sequence B (0 1 0).  
 Use a 9001KA2 mounted on side no. 1 or 2 for sequence C (0 0 1).

The L cam type is chosen:  
 Use a 9001KA2 mounted on side no. 2 for sequence A (1 0 0).  
 Use a 9001KA2 mounted on side no. 1 or a 9001KA3 mounted on side no. 2 for sequence B (0 1 0).  
 Use a 9001KA3 mounted on side no. 1 for sequence C (0 0 1).

One Type KA1 double circuit block can be used in place of one Type KA2 single circuit block plus one Type KA3 single circuit block mounted on the same side.



**Table 1: 2 Position Selector Switch**

If you require contact sequence...		Use Cam Type	Use Contact Block Type	Mount on side no. (See page 17-80)
↙	↘			
1	0	E	KA3	1 or 2
		D	KA2	1 or 2
0	1	E	KA2	1 or 2
		D	KA3	1 or 2

**Table 2: 3 Position Selector Switch**

If you require contact sequence...			Use Cam Type	Use Contact Block Type	Mount on side no. (See page 17-80)
↙	↑	↘			
1	0	0	G	KA2	1
			L	KA2	2
			C E	KA3	1
			B C E F G J	KA3	2
0	1	0	D E J L	KA2	1
			D E	KA2	2
			F	KA3	1
			L	KA3	2
0	0	1	C F	KA2	1 or 2
			B D G L	KA3	1
			B	KA5▲	1
			M	KA2	2
1	1	0	B	KA2	1
			C F	KA5▲	1 or 2
			M	KA3	2
0	1	1	B G J	KA2	2
			G	KA5▲	1
			L	KA5▲	2
			M	KA3	1
1	0	1	D E J L	KA5▲	1
			D E	KA5▲	2

**Table 3: 4 Position Selector Switch**

If you require contact sequence...				Use Cam Type	Use Contact Block Type	Mount on side no. (See page 17-80)
↙	↘	↙	↘			
1	0	0	0	H	(A) KA3	2
0	1	0	0	H	(B) KA2	1
0	0	1	0	H	(C) KA2	2
0	0	0	1	H	(D) KA3	1
1	0	0	1	H	A & D Wired in Parallel	
1	1	0	0	H	A & B Wired in Parallel	
0	1	1	0	H	B & C Wired in Parallel	
0	0	1	1	H	C & D Wired in Parallel	
1	1	1	0	H	A, B & C Wired in Parallel	
0	1	1	1	H	B, C & D Wired in Parallel	
1	0	1	0	H	A & C Wired in Parallel	
0	1	0	1	H	B & D Wired in Parallel	
1	1	0	1	H	KA5▲	2
1	0	1	1	H	KA5▲	1



▲ Type KA5 must be the last block on either side. If more than one KA5 is required on either side—contact your local Square D sales office.



**Pilot Lights—UL Types 4, 13/NEMA 4 & 13**

For use in hazardous locations—See page 17-79.

Legend plates not included.



Description	Voltage	Style	With Red Fresnel Color Cap	With Green Fresnel Color Cap	With Other Color Cap	Price	Without Color Cap	Price
 Standard Pilot Light (Plastic Fresnel Color Cap Shown)	110–120 V, 50–60 Hz 220–240 V, 50–60 Hz 24–28 Vac/dc	Transformer Transformer Full Voltage	KP1R31 KP7R31 KP35R31	KP1G31 KP7G31 KP35G31	KP1■ KP7■ KP35■	\$102. 102. 83.	KP1 KP7 KP35	\$95. 95. 77.
	For Other Voltages See table on page 17-77.	Transformer, Flashing or LED ♦ Full Voltage, Neon or Resistor ★	KP▲R31 KP▲R31	KP▲G31 KP▲G31	KP▲■ KP▲■	102. 83.	KP▲ KP▲	95. 77.
 Push-To-Test Pilot Light (Glass Color Cap Shown)	110–120 V, 50–60 Hz 220–240 V, 50–60 Hz 24–28 Vac/dc	Transformer Transformer Full Voltage	KT1R31 KT7R31 KT35R31	KT1G31 KT7G31 KT35G31	KT1■ KT7■ KT35■	131. 131. 111.	KT1 KT7 KT35	123. 123. 105.
	For Other Voltages See table on page 17-77.	Transformer, Flashing or LED ♦ Full Voltage, Neon or Resistor ★	KT▲R31 KT▲R31	KT▲G31 KT▲G31	KT▲■ KT▲■	131. 111.	KT▲ KT▲	123. 105.
 Remote Test Pilot Light (Glass Color Cap Shown)	120 Vac Only 24–28 Vac Only For Other Voltages	Resistor ▼ Full Voltage ▼	KTR38R31 KTR35R31	KTR38G31 KTR35G31	KTR38■ KTR35■	131. 131.	KTR38 KTR35	123. 123.
	See table on page 17-77. ▼	Full Voltage or Resistor ▼	KTR▲R31	KTR▲G31	KTR▲■	131.	KTR▲	123.

- ▲ Add the voltage assembly code as chosen from table on page 17-77.  
**EXAMPLE: KT▲R31 with 60 Vac red LED = KT37LRR31**
- Add the color code as chosen from the color cap table.  
**EXAMPLE: KP1■ with a blue fresnel cap = KP1L31**
- ♦ The cap must be the same color as the LED light module chosen, e.g., for green LED, use green color cap.
- ★ On neon light modules, use clear color caps only.
- ▼ On remote test pilot lights use only full voltage or resistor voltage assembly codes.  
 Do not choose LED, neon or transformer codes. For AC use only.

**Push-to-Test Ground Detector Pilot Light**  
 (Contact Block Included—But NOT Legend Plate or Color Cap)

Used in pairs to indicate a grounded condition in a control circuit fed from a grounded center-tapped transformer. The Type KT50 is commonly used in press control circuits, and fulfills the requirements of the ground detector called for in ANSI B11.1 (1971), Par. E3.6.5. Consult local Square D sales office for proper application.

Voltage and Frequency	Type	Price
110–120 V, 50–60 Hz	KT50	\$171.

Color			
	■ Plastic Fresnel	■ Plastic Domed	■ Glass
Amber	A31	A9	A6
Blue	L31	L9	L6
Clear	C31	C9	C6
Green	G31	G9	G6
Red	R31	R9	R6
White	W31	W9	W6
Yellow	Y31	Y9	Y6

**Typical Wiring Diagrams**

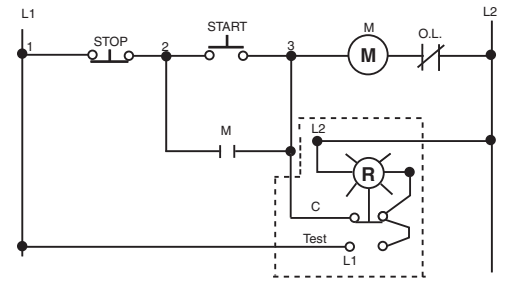

**Push-To-Test Pilot Light**

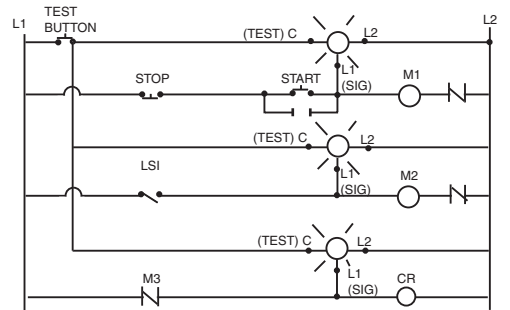

**Remote Test Pilot Light**

For additional information, reference Catalog #9001CT0001.



Without Latch



With Latch

**Joy Stick Operators—UL Types 4, 13/NEMA 4, 13**

For use in hazardous locations—See page 17-79.  
Contact blocks and legend plate not included unless otherwise noted.

Description				Operator With Contacts	Price	Operator Without Contacts	Price
↕	3 Position—Center Off	Momentary Contact—Spring Return to Center	Without Latch	K71H7	\$197.	K71	\$168.
			With Latch	K70H7		K70	
		Maintained Contact	Without Latch	K73H7		K73	
			With Latch	K72H7		K72	
↔	3 Position—Center Off	Momentary Contact—Spring Return to Center	Without Latch	K31H8	197.	K31	168.
			With Latch	K30H8		K30	
		Maintained Contact	Without Latch	K33H8		K33	
			With Latch	K32H8		K32	
⬠	5 Position—Center Off	Momentary Contact—Spring Return to Center	Without Latch	K35H2	263.	K35	206.
			With Latch	K34H2		K34	
		Maintained Contact	Without Latch	K37H2		K37	
			With Latch	K36H2		K36	

▲ These operators can be ordered complete with contact blocks—a total of four (4) contact blocks can be used. Add the "H" number chosen from page 17-80 to the operator type number and add the cost of the "H" number to the operator cost.

**Contact Arrangements**

Operator Positions	Contact Block Type	Contact Block Location	Contact	Handle position (with ref. to Nib)				
				1 ↑	2 →	OFF	3 ↓	4 ←
↔	3	KA3 POS 1 (3)	A	...	1	0	...	0
		KA3 POS 2 (4)	A	...	0	0	...	1
↕	3	KA2 POS 1 (3)	B	1	...	0	0	...
		KA2 POS 2 (4)	B	0	...	0	1	...
⬠	5	KA1 POS 1 (3)	A	0	1	0	0	0
			B	1	0	0	0	0
		KA1 POS 2 (4)	A	0	0	0	0	1
			B	0	0	0	1	0

(1) Contact Closed (0) Contact Open

The joy stick operator is ideal for applications where only one circuit is to be energized at one time. The three position joy stick closes one circuit in each Up-Down or Right-Left position with all circuits open in center position. The five position operator closes one circuit in each Up, Down, Left and Right position with all circuits open in center position. Momentary contact operators are spring return to the center position. Maintained operators remain in position and must be returned manually. Operators with latch cannot be operated until the latch button in center of handle is pressed.

**Selector Push Button Operators—UL Types 4, 13/NEMA 4, 13**

For use in hazardous locations—See page 17-79.  
Legend plate and contact block not included.

**Inserts** are field convertible. For colors not listed, order operator without insert, plus separate color insert from page 17-84. Up to two Type KA contact blocks can be mounted in tandem (total of four blocks). Selector push buttons cannot be illuminated.

Contact Block Required	Quantity and Type	Mount on Side	Two Position Operators												Three Position Operators			Order Contact Blocks From Pages 17-78, 17-79.
			0—Contact Open				1—Contact Closed				F—Free D—Depressed				Left	Center	Right	
			Left	Right	Left	Right	Left	Right	Left	Right	Left	Right	Left	Right				
1-KA-1	Q1	#2	0 0	1 0	0 0	1 0	0 0	1 1	1 1	1 0	1 0	0 0	1 0	...	0	1 0	1 0	1 1
1-KA-1	Q1	#1	0 0	1 1	0 0	1 0	1 1	0 0	1 0	1 1	1 1	0 0	1 0	...	0	1 1	1 0	1 0

■ Order color inserts from page 17-84.  
♦ Cams are not interchangeable.  
★ Maintained in right position only. Function in the right position is similar to a turn to release action. Refer to the PB Specifier's Guide, pg. 137.

**Key Operated Push Button – UL Types 4, 13/NEMA 4, 13**

For use in hazardous locations. See page 17-79.

**Key operated push buttons** are used wherever unauthorized use of a push button is discouraged. Examples are locking a Start push button in the extended position or locking a Stop push button in the depressed position. The operator can also be locked in the flush position—holding all contacts open. **Up to two Type KA contact blocks can be mounted in tandem (total of four blocks).**

**Legend Plate and Contact Block Not Included**

Description	Lockable Positions			Type	Price
	Extended	Flush	Depressed		
Push button operable only with key in lock. Key is removable in locked position only.	X ... ... X	... X ... X	... ... X X	KR131 KR132 KR133 KR137	\$83.
Push button operable with or without key in lock. Push button can be locked with key only. Key removable in both locked or unlocked position.	X ... ... X	... X ... X	... ... X X	KR141 KR142 KR143 KR147	
To lock the unit, rotate the key with the button in the extended position. Then, push the button to lock it in the position indicated at right. Key is removable only in this position.	... ... ...	X ... ...	... ... X	KR152 KR153	

All key operated push buttons are furnished as standard with Square D no. E10 key change. See page 17-63 for other key changes (Note 4).

For additional information, reference Catalog #9001CT0001.



**Potentiometer with Dial Plate 9001K21**

**Potentiometer with Dial Plate ▲—NEMA 4, 13 (Not UL Listed)**

Watts		Description		Type		Price		
2		Operator only—Single Pot		K20		\$134.		
		Operator with Single Pot		K21 ■		191.		
		Operator only—Tandem Pot		K22		209.		
		Operator with Tandem Pot		K23 ♦		266.		

Suffix ■	Ohms	Suffix ■	Ohms	Suffix ■	Ohms	Suffix ♦	Tandem Pots Ohms	
							Front	Rear
01	50	07	5k	13	500k	82	1000	1000
02	100	08	10k	37	750k	83	5000	5000
38	200	40	15k	14	1.0 M	85	10k	10k
03	250	09	25k	15	2.5 M	88	50k	50k
04	500	35	35k	16	5.0 M	89	100k	100k
05	1000	10	50k	17	5.0 M			
32	1500	36	75k					
39	2000	11	100k					
06	2500	12	250k					
33	3500							

▲ The dial plate only catalog number is 651580090501. \$2.90.  
 ■ For complete Type number, add suffix number from table above. Example: Type K2105  
 ♦ For complete Type number, add suffix number from table above. Example: Type K2382



**Emergency Break-Glass Operator 9001K15**

**Emergency Break-Glass Operator—UL 4, 13/NEMA 4, 13\***

Operator is held in a depressed position by a glass disc. When the glass disc is broken with the hammer, button returns to a normal extended position. Package of 5 discs included with operator.

Type	Price
K15	\$83.

**9001K15 Replacement Parts**

Description	Part Number	Price
Yellow bumper	3105211101	\$ 9.50
Hammer and chain	3105206750	19.10
Lower ring nut	6512232801	11.10
Top ring nut	9001K40	2.90
Package of 5 replacement discs	9001K57	11.10
Clip to hold hammer	2540902240	1.70

\* For enclosed versions see page 17-103.



**Rocker Arm Operating Lever 9001K50**

**Rocker Arm Operating Lever**

Allows two standard push buttons to be operated independently of each other. Price does not include push buttons or legend plates. Order push buttons and legend plates from Pages 17-81, 17-82, and 17-56—specify which marking is to be inverted.

Type	Price
K50	\$51.00



**Push-on Push-off Module 9001K85**

**Alternate Action—Push-on, Push-off Module**

This module can be added to standard 9001 Type K, KX, SK or T momentary push button operators. Contact blocks mounted behind this module (maximum of 2) are held in the depressed position when the operator is pressed once, and released to their normal position when the operator is pressed again. For a N.C. circuit, use a 9001KA3 or the N.C. contact of either a 9001KA1 or 9001KA4. For a N.O. circuit, use the N.O. contact of either a 9001KA4 or 9001KA6.

Type	Price
K85	\$28.50



**Time Delay Push Button 9001KRD**

**Off Delay Push Button—UL Types 4, 13/NEMA 4, 13**

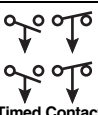
Description	Type (All Colors)			Price
	Full Guard	Extended Guard	No Guard	
 Timed Contact 1 N.O. and 1 N.C.	KRD1UH1	KRD2UH1	KRD3UH1	\$168.
 Timed Contact 2 N.O. and 2 N.C.	KRD1UH2	KRD2UH2	KRD3UH2	311.

Timing period is adjustable from 0.1 second to 60 seconds and begins after button has been released. Devices include a pack of seven color inserts for color coding the push button. See 17-84 for Universal color insert. Contacts are quick make-quick break.

**Note:** When mounted in top or bottom hole of a Type K enclosure, device requires one additional space below or above operator. When mounted other than in top or bottom hole, device may require two additional spaces, one above and one below operator. Closing plates must be installed on unused holes.

**Wobble Stick For easy operation of any standard push button.**



Type	Price
K8	\$28.50

For additional information, reference Catalog #9001CT0001.

# Push Buttons—Class 9001 Type SK—30 mm

## Corrosion Resistant Non-Illuminated Operators

**SQUARE D**  
www.SquareD.com  
For the most up-to-date information

### Non-Illuminated Momentary Push Button Operators—UL Types 4, 4X, 13/NEMA 4, 4X, 13

For use in hazardous locations—See page 17-79.  
Contact blocks and legend plate not included unless otherwise noted.

Description	Color	Operator with 1 N.O. and 1 N.C. Contact (KA1)	Price	Operator with 1 N.O. Contact (KA2)	Operator with 1 N.C. Contact (KA3)	Price	Operator Only No Contacts ▼	Price
 9001SKR1B Full Guard	Black	SKR1BH13	\$54.00	SKR1BH5	SKR1BH6	\$39.90	SKR1B	\$25.70
	Red	SKR1RH13	54.00	SKR1RH5	SKR1RH6	39.90	SKR1R	25.70
	Green	SKR1GH13	54.00	SKR1GH5	SKR1GH6	39.90	SKR1G	25.70
	Universal ▲	SKR1UH13	54.00	SKR1UH5	SKR1UH6	39.90	SKR1U	25.70
	Other ■	SKR1■H13	54.00	SKR1■H5	SKR1■H6	39.90	SKR1■	25.70
 9001SKR3B No Guard	Black	SKR3BH13	54.00	SKR3BH5	SKR3BH6	39.90	SKR3B	25.70
	Red	SKR3RH13	54.00	SKR3RH5	SKR3RH6	39.90	SKR3R	25.70
	Green	SKR3GH13	54.00	SKR3GH5	SKR3GH6	39.90	SKR3G	25.70
	Universal ▲	SKR3UH13	54.00	SKR3UH5	SKR3UH6	39.90	SKR3U	25.70
	Other ■	SKR3■H13	54.00	SKR3■H5	SKR3■H6	39.90	SKR3■	25.70
 9001SKR2B Extended Guard	Black	SKR2BH13	54.00	SKR2BH5	SKR2BH6	39.90	SKR2B	25.70
	Red	SKR2RH13	54.00	SKR2RH5	SKR2RH6	39.90	SKR2R	25.70
	Green	SKR2GH13	54.00	SKR2GH5	SKR2GH6	39.90	SKR2G	25.70
	Universal ▲	SKR2UH13	54.00	SKR2UH5	SKR2UH6	39.90	SKR2U	25.70
	Other ■	SKR2■	54.00	SKR2■H5	SKR2■H6	39.90	SKR2■	25.70

▲ The universal push button operators include one each of the following color inserts: black, red, green, yellow, orange, blue and white.  
■ See table below.

Description	Color	Operator with 1 N.O. and 1 N.C. Contact (KA1)	Price	Operator with 1 N.O. Contact (KA2)	Operator with 1 N.C. Contact (KA3)	Price	Operator Only No Contacts ▼	Price
<b>Snap-In Mushroom Button</b>								
 9001SKR4B 1 3/8 Mushroom Button	Black	SKR4BH13	\$83.00	SKR4BH5	SKR4BH6	\$68.00	SKR4B	\$54.00
	Red	SKR4RH13	83.00	SKR4RH5	SKR4RH6	68.00	SKR4R	54.00
	Red ♦	SKR4R05H13	86.00	SKR4R05H5	SKR4R05H6	72.00	SKR4R05	57.00
	Green	SKR4GH13	83.00	SKR4GH5	SKR4GH6	68.00	SKR4G	54.00
	Other ★	SKR4★H13	83.00	SKR4★H5	SKR4★H6	68.00	SKR4★	54.00
<b>Screw-On Mushroom Button with Set Screw Security</b>								
 9001SKR5B 2 1/4 Mushroom Button	Black	SKR24BH13	83.00	SKR24BH5	SKR24BH6	68.00	SKR24B	54.00
	Red	SKR24RH13	83.00	SKR24RH5	SKR24RH6	68.00	SKR24R	54.00
	Green	SKR24GH13	83.00	SKR24GH5	SKR24GH6	68.00	SKR24G	54.00
	Other ★	SKR24★H13	83.00	SKR24★H5	SKR24★H6	68.00	SKR24★	54.00
	<b>Snap-In Mushroom Button</b>							
 9001SKR5B 2 1/4 Mushroom Button	Black	SKR5BH13	83.00	SKR5BH5	SKR5BH6	68.00	SKR5B	54.00
	Red	SKR5RH13	83.00	SKR5RH5	SKR5RH6	68.00	SKR5R	54.00
	Red ♦	SKR5R05H13	86.00	SKR5R05H5	SKR5R05H6	72.00	SKR5R05	57.00
	Green	SKR5GH13	83.00	SKR5GH5	SKR5GH6	68.00	SKR5G	54.00
	Other ★	SKR5★H13	83.00	SKR5★H5	SKR5★H6	68.00	SKR5★	54.00
<b>Screw-On Mushroom Button with Set Screw Security</b>								
 9001SKR5B 2 1/4 Mushroom Button	Black	SKR25BH13	83.00	SKR25BH5	SKR25BH6	68.00	SKR25B	54.00
	Red	SKR25RH13	83.00	SKR25RH5	SKR25RH6	68.00	SKR25R	54.00
	Green	SKR25GH13	83.00	SKR25GH5	SKR25GH6	68.00	SKR25G	54.00
	Other ★	SKR25★H13	83.00	SKR25★H5	SKR25★H6	68.00	SKR25★	54.00

♦ Knob has the words "Emergency Stop" in raised letters highlighted in white for readability.  
★ See table below.

▼ These operators can be ordered complete with contact blocks. For maximum block usage, see page 17-85. Add the "H" number chosen from page 17-80 to the end of the operator type number and add the cost of the "H" number to the operator cost.

Color	■ SKR1, 2, 3 Place Color Code in Type Number	★ SKR4, 5, 24, 25 Place Color Code in Type Number
Blue	L	L
Yellow	Y	Y
White	W	...
Orange	S	S
Gray	E	...

Light Modules .....	page 17-77
Contact Blocks .....	page 17-78
H Contact Block Assembly Codes .....	page 17-80
Legend Plates .....	page 17-81
Accessories .....	page 17-83
Replacement Parts .....	page 17-86

For additional information, reference Catalog #9001CT0001.

**Multifunction Operators—UL Types 4, 4X, 13/NEMA 4, 4X, 13**

For use in hazardous locations—See page 17-79.  
Legend plate and contact blocks not included unless otherwise noted.

	Description	Color	Contacts ☆	Price	Without Contacts ◇	Price
 <b>9001SKR11U</b>	Interlocked Assembly Both Buttons Maintained	Universal ▲ Other ■	SKR11UH1 SKR11■H1	\$108. 108.	SKR11U SKR11■	\$80. 80.
	Interlocked Assembly One Button Momentary One Button Maintained	Universal ▲ Other ■	SKR12UH1H1 SKR12■H1H1	165. 165.	SKR12U SKR12■	108. 108.

▲ Universal for SKR11,12 includes 2 each of black, red, green, yellow, orange, blue, white.  
■ Choose one color for each button from table and insert color code in type number, top button first.  
**EXAMPLE: An SKR11 with top button gray and bottom button orange = SKR11ES**

Non-Illuminated	Description	Color	With 2 N.C. Contacts (1 KA3, 1 KA5)	With 1 N.O./1 N.C. Contact (1 KA1)	Price	Without Contacts ◇	Price
 <b>9001SKR9R</b> <b>Non-Illuminated</b> 1 5/8" Diameter Knob Includes Type KN179WP Legend Plate Marked Pull To Start Push To Stop	3 POSITION Momentary Pull- Maintained Neutral- Momentary Push	Red Green Other ★	SKR8RH25 SKR8GH25 SKR8★H25	... ... ...	\$86. 86. 86.	SKR8R SKR8G SKR8★	\$57. 57. 57.
	2 POSITION ◆ Maintained Pull- Maintained Push	Red Green Other ★	... ... ...	SKR9RH13 SKR9GH13 SKR9★H13	114. 114. 114.	SKR9R SKR9G SKR9★	86. 86. 86.

Illuminated	Description	Voltage	With Red Knob and 2 N.C. Contacts (1 KA3, 1 KA5)	With Other Color Knob and 2 N.C. Contacts (1 KA3, 1 KA5)	Price	With Other Color Knob Without Contacts ◇	Price
 <b>9001SKR9P1</b> <b>Illuminated</b> 1 5/8" Diameter Knob Includes Type KN179WP Legend Plate Marked Pull To Start Push To Stop	3 POSITION Momentary Pull- Maintained Neutral- Momentary Push	110–120 V, 50–60 Hz Other—Transformer, LED, Flashing △ Other—Full Voltage, Resistor, Neon □	SKR8P1RH25 SKR8P▼RH25 SKR8P▼RH25	SKR8P1★H25 SKR8P▼★H25 SKR8P▼★H25	\$162. 162. 143.	SKR8P1★ SKR8P▼★ SKR8P▼★	\$134. 134. 114.
	2 POSITION Maintained Pull- Maintained Push	110–120 V, 50–60 Hz Other—Transformer, L.E.D., Flashing △ Other—Full Voltage, Resistor, Neon □	SKR9P1RH13 SKR9P▼RH13 SKR9P▼RH13	SKR9P1★H13 SKR9P▼★H13 SKR9P▼★H13	\$191. 191. 171.	SKR9P1★ SKR9P▼★ SKR9P▼★	\$162. 162. 143.

◆ To obtain a red knob with "Push Emergency Stop" printed on the red knob—substitute "ROS" in place of "R" and add \$2.10 to the price.  
★ Choose one color from table and insert color code in type number.  
**EXAMPLE: SKR9★ with a yellow knob = SKR9Y**  
▼ Add the voltage assembly code as chosen from table on page 17-77.  
**EXAMPLE: SKR8P▼ with 277 V 50–60 Hz = SKR8P8**  
△ The knob must be the same color as the LED light module chosen; e.g., for green LED, use green knob.  
□ On neon light modules, use clear knobs only.  
◇ These operators can be ordered complete with contact blocks. For maximum block usage, see page 17-85. Add the "H" number chosen from page 17-80 to the end of the operator type number and add the cost of the "H" number to the operator cost.  
★ SKR11UH1 has 1 KA1(1 N.O., 1 N.C.) and SKR12UH1H1 has 2 KA1 (2 N.O., 2 N.C.).

Color	SKR11, SKR12■	SKR8, SKR9
Black ▽	B	B
Red	R	R
Green	G	G
Blue	L	L
Yellow	Y	Y
White	W	W
Orange ▽	S	S
Clear	...	C
Amber	...	A
Gray	E	...

▽ These colors are not available on illuminated push-pull operators.





For additional information, reference Catalog #9001CT0001.

# Push Buttons—Class 9001 Type SK—30 mm

## Corrosion Resistant Operators

### Illuminated Push Button Operators—UL Types 4, 4X, 13/NEMA 4, 4X, 13

For use in hazardous locations—See page 17-79.  
Legend plate not included unless otherwise noted.

Description	Voltage and Frequency	Style	With Red Color Cap and 1 N.O. and 1 N.C. Contact (KA1)	With Green Color Cap and 1 N.O. and 1 N.C. Contact (KA1)	Price □	With Other Color Cap Without Contact Blocks ▲	Price ◇
 9001SK1L1	110–120 V, 50–60 Hz	Transformer	SK1L1RH13	SK1L1GH13	\$140.	SK1L1 ★	\$111.
	220–240 V, 50–60 Hz	Transformer	SK1L7RH13	SK1L7GH13	140.	SK1L7 ★	111.
	24–28 Vac/dc	Full Voltage	SK1L35RH13	SK1L35GH13	120.	SK1L35 ★	92.
	For other voltages See Table ■	Transformer, Flashing	SK1L■RH13	SK1L■GH13	140.	SK1L ■★	111.
		Full Voltage	SK1L■RH13	SK1L■GH13	120.	SK1L ■★	92.
		Resistor, Neon ◆	SK1L■RH13	SK1L■GH13	120.	SK1L ■★	92.
LED ▼		SK1L■RH13	SK1L■GH13	140.	SK1L ■★	111.	
 9001SK2L1	110–120 V, 50–60 Hz	Transformer	SK2L1RH13	SK2L1GH13	131.	SK2L1 ★	102.
	220–240 V, 50–60 Hz	Transformer	SK2L7RH13	SK2L7GH13	131.	SK2L7 ★	102.
	24–28 Vac/dc	Full Voltage	SK2L35RH13	SK2L35GH13	111.	SK2L35 ★	83.
	For other voltages See Table ■	Transformer, Flashing	SK2L■RH13	SK2L■GH13	131.	SK2L ■★	102.
		Full Voltage	SK2L■RH13	SK2L■GH13	111.	SK2L ■★	83.
		Resistor, Neon ◆	SK2L■RH13	SK2L■GH13	111.	SK2L ■★	83.
LED ▼		SK2L■RH13	SK2L■GH13	131.	SK2L ■★	102.	
 9001SK2L1R20	110–120 V, 50–60 Hz	Transformer	SK2L1R20H13	SK2L1G20H13	131.	Order SK2L■★△	
	220–240 V, 50–60 Hz	Transformer	SK2L7R20H13	SK2L7G20H13	131.		
	24–28 Vac/dc	Full Voltage	SK2L35R20H13	SK2L35G20H13	111.		
	For other voltages See Table ■	Transformer, Flashing	SK2L■R20H13	SK2L■G20H13	131.		
		Full Voltage	SK2L■R20H13	SK2L■G20H13	111.		
		Resistor, Neon ◆	SK2L■R20H13	SK2L■G20H13	111.		
LED ▼		SK2L■R20H13	SK2L■G20H13	131.			
 9001SK2L1R21	110–120 V, 50–60 Hz	Transformer	SK2L1R21H13	SK2L1G21H13	131.	Order SK2L■★△	
	220–240 V, 50–60 Hz	Transformer	SK2L7R21H13	SK2L7G21H13	131.		
	24–28 Vac/dc	Full Voltage	SK2L35R21H13	SK2L35G21H13	111.		
	For other voltages See Table ■	Transformer, Flashing	SK2L■R21H13	SK2L■G21H13	131.		
		Full Voltage	SK2L■R21H13	SK2L■G21H13	111.		
		Resistor, Neon ◆	SK2L■R21H13	SK2L■G21H13	111.		
LED ▼		SK2L■R21H13	SK2L■G21H13	131.			

- ▲ These operators can be ordered complete with contact blocks. For maximum block usage, see page 17-85. Add the "H" number chosen from page 17-80 to the end of the operator type number and add the cost of the "H" number to the operator cost.
- Add the voltage assembly code as chosen from table on page 17-77.  
**EXAMPLE: SK2L■ with 240 Vac/dc = SK2L25.**
- ◆ On neon light modules, use clear color caps only.
- ★ The cap must be the same color as the LED light module chosen e.g., for red LED, use red color cap.
- ▼ Add the color code as chosen from the color cap table below.  
**EXAMPLE: SK2L25▼ with a blue 13/8" mushroom button = SK2L25L20.**
- △ The only difference between a no guard (SK2L) operator and mushroom button operator is the color cap.
- Price includes operator, light module, contact blocks and color cap.
- ◇ Price includes operator, light module and color cap.

### Color Caps

Color	Color Codes		
	SK1L SK2L	1 3/8 Inch Mushroom	2 1/4 Inch Mushroom
Red	R	R20	R21
Green	G	G20	G21
Blue	L	L20	L21
Yellow	Y	Y20	Y21
White	W	W20	W21
Clear	C	C20	C21
Amber	A	A20	A21

Light Modules .....	page 17-77
Contact Blocks .....	page 17-78
H Contact Block Assembly Codes .....	page 17-80
Legend Plates .....	page 17-81
Accessories .....	page 17-83
Replacement Parts .....	page 17-86

For additional information, reference Catalog #9001CT0001.

**Non-Illuminated 2 Position Selector Switch Operators—UL Types 4, 4X, 13/NEMA 4, 4X, 13**

For use in hazardous locations—See page 17-79.  
Legend plate and contact block not included unless noted.



**Standard Knob Selector Switch 9001SKS**

Contact Block Required				1—Contact Closed 0—Contact Open			
Contact Block Position	Quantity and Type	Mount on Side	Left		Right		
			Left	Right	Left	Right	
 <b>Top View</b>	KA1 	KA1 #2 or	KA3 #2 	1	0	0	1
	KA2 		KA2 #2 	0	1	1	0
	KA1 	KA1 #1 or	KA3 #1 	1	0	0	1
	KA2 		KA2 #1 	0	1	1	0

Cam (see page 17-64) Non-Illuminated Operators	E		D	Price
	Type	Type	Type	
Manual Return Operator Only ▲ Without Knob With Standard Black Knob With Other Color Knob (See Knob Table) ■	SKS11 SKS11B SKS11■	SKS12 SKS12B SKS12■		\$28.50 35.10 35.10
With Contact Block(s) With Standard Black Knob (From Table for Other Colors, Replace B in Type Number with Color Code) With 1 KA1 on Side #2 (H13) With 1 KA1 on Side #1 (H1) With 1 KA1 on Side #1 and 1 KA1 on Side #2 (H2)	SKS11BH13 SKS11BH1 SKS11BH2	...		64.00 64.00 92.00
Spring Return from Left Operator Only ▲ Without Knob With Standard Black Knob With Other Color Knob (See Knob Table) ■	SKS25 SKS25B SKS25■	...		47.60 54.00 54.00
Spring Return From Right Operator Only ▲ Without Knob With Standard Black Knob With Other Color Knob (See Knob Table) ■	...	SKS34 SKS34B SKS34■		47.60 54.00 54.00

▲ These operators can be ordered complete with contact blocks. For maximum block usage, see page 17-85. Add the "H" number chosen from page 17-80 to the end of the operator type number and add the cost of the "H" number to the operator cost.  
**Example: SKS11FB + H13 = SKS11FBH13**  
 ■ Add the color code as chosen from knob color table below.  
**Example: SKS11■ with a green gloved-hand knob = SKS11FG**

**Selector Switch Knobs**

Color	Standard Knob		Gloved-Hand Knob		Coin Operated		Price
	Knob Code	Type	Knob Code	Type	Knob Code	Type	
Black	B	B11	FB	B25	TB	B18	\$6.60
Red	R	R8	FR	R24	TR	R16	
Green	G	G8	FG	G24	TG	G16	
Yellow	Y	Y8	FY	Y24	TY	Y16	
Orange	S	S11	FS	S25	...	...	
Blue	L	L8	FL	L24	TL	L16	
White	W	W8	FW	W24	...	...	
Amber	A	A8	FA	A24	...	...	
Clear	C	C8	FC	C24	TC	C16	

For additional information, reference Catalog #9001CT0001.

**Illuminated 2 Position Selector Switch Operators—UL Types 4, 4X, 13/NEMA 4, 4X, 13**

For use in hazardous locations—See page 17-79.  
Legend plate and contact block not included unless noted.

Contact Block Required			1—Contact Closed 0—Contact Open				
Contact Block Position	Quantity and Type	Mount on Side	Left		Right		
			↙	↘	↙	↘	
<p>Top View</p>	KA1 	KA1 #2	KA3	↙	↘	↙	↘
	KA2 		KA3 #2	1	0	0	1
	KA1 	KA1 #1	KA2	↙	↘	↙	↘
	KA2 		KA3 #1	0	1	1	0
KA1 	KA2 	KA3 #1	1	0	0	1	
KA1 	KA2 	KA2 #1	0	1	1	0	



Cam (see page 17-64) Illuminated Operators	E	D	Price
	Type	Type	
Manual Return ▲ Without Knob, 110–120 V 50–60 Hz Transformer With Standard Red Knob, 110–120 V 50–60 Hz Transformer Without Knob and Other Voltage Transformer, Flashing or LED ★ Without Knob, Full Voltage Neon or Resistor ▼ With Other Color Knob and Transformer, Flashing or LED ★ With Other Color Knob, Full Voltage Neon or Resistor ▼	SK11J1 SK11J1R SK11J■ SK11J◆ SK11J◆♦	SK12J1 SK12J1R SK12J■ SK12J◆ SK12J◆♦	\$105. 111. 105. 86. 111. 92.
Spring Return from Left ▲ Without Knob, 110–120 V 50–60 Hz Transformer With Standard Red Knob, 110–120 V 50–60 Hz Transformer Without Knob and Other Voltage Transformer, Flashing or LED ★ Without Knob, Full Voltage Neon or Resistor ▼ With Other Color Knob and Transformer, Flashing or LED★ With Other Color Knob, Full Voltage Neon or Resistor ▼	SK25J1 SK25J1R SK25J■ SK25J◆ SK25J◆♦	...	123. 131. 123. 105. 131. 111.
Spring Return From Right ▲ Without Knob, 110–120 V 50–60 Hz Transformer With Standard Red Knob, 110–120 V 50–60 Hz Transformer Without Knob and Other Voltage Transformer, Flashing or LED ★ Without Knob, Full Voltage Neon or Resistor ▼ With Other Color Knob and Transformer, Flashing or LED ★ With Other Color Knob, Full Voltage Neon or Resistor ▼	...	SK34J1 SK34J1R SK34J■ SK34J◆ SK34J◆♦	123. 131. 123. 105. 131. 111.

- ▲ These operators can be ordered complete with contact blocks. For maximum block usage, see page 17-85. Add the "H" number chosen from page 17-80 to the end of the operator type number and add the cost of the "H" number to the operator cost.
- Add the voltage assembly code as chosen from table on page 17-77.  
**Example: SK25J■ with 60 Vac/dc = SK25J37**
- ◆ Add the color code as chosen from the knob color table below.  
**Example: SK25J35◆ with green knob = SK25J35G**
- ★ The knob must be the same color as the LED light module chosen e.g., for red LED, use red knob.
- ▼ On neon light modules, use clear knobs only.

**Two Color Selector Switch**

Used to indicate red in left position and green in right position on illuminated operators.

Knob	Factory Assembled Form Number△	Price Adder
Standard	Y178	\$19.
Gloved-Hand	Y1781	19.

△ Add form number to standard Type number, e.g., Type SK11J1 Form Y178.

**Selector Switch Knobs**

Color	Standard Knob		Gloved-Hand Knob		Coin Operated		Price
	◆ Knob Code	Type	◆ Knob Code	Type	◆ Knob Code	Type	
Red	R	R8	FR	R24	TR	R16	\$6.60
Green	G	G8	FG	G24	TG	G16	
Yellow	Y	Y8	FY	Y24	TY	Y16	
Blue	L	L8	FL	L24	TL	L16	
White	W	W8	FW	W24	...	...	
Amber	A	A8	FA	A24	...	...	
Clear	C	C8	FC	C24	TC	C16	

Light Modules	page 17-77
Contact Blocks	page 17-78
H Contact Block Assembly Codes	page 17-80
Legend Plates	page 17-81
Accessories	page 17-83
Replacement Parts	page 17-86

For additional information, reference Catalog #9001CT0001.



**Non-Illuminated 3 Position Selector Switch Operators—UL Types 4, 4X, 13/NEMA 4, 4X, 13**

For use in hazardous locations—See page 17-79.  
Legend plate and contact block not included unless noted.

CONTACT BLOCK REQUIRED			1 — Contact Closed						0 — Contact Open			
CONTACT BLOCK POSITION	Quantity and Type	Mount on Side	Center	Center	Center	Center	Center	Center	Center	Center	Center	
<p>Top View</p>	KA3	KA3 #2	1 0 0	1 0 0	0 0 1	1 0 0	1 0 0	1 0 0	1 0 0	1 0 0	0 1 0	1 1 0
	KA2	KA2 #2	0 1 1	0 0 1	0 1 0	0 1 0	0 0 1	0 1 1	0 1 1	0 1 1	1 0 0	0 0 1
	KA3	KA3 #1	0 0 1	1 0 0	0 0 1	1 0 0	0 1 0	0 0 1	1 0 1	0 0 1	0 0 1	0 1 1
	KA2	KA2 #1	1 1 0	0 0 1	0 1 0	0 1 0	0 0 1	1 0 0	0 1 0	0 1 0	0 1 0	1 0 0
Cam (see page 17-64)			B	C	D	E	F	G	J	L	M	Price
Non-Illuminated Operators			Type	Type	Type	Type	Type	Type	Type	Type	Type	
Manual Return Operator Only ▲												
Without Knob			SKS42	SKS43	SKS44	SKS45	SKS46	SKS47	SKS49	SKS401	SKS402	\$28.50
With Standard Black Knob			SKS42B	SKS43B	SKS44B	SKS45B	SKS46B	SKS47B	SKS49B	SKS401B	SKS402B	35.10
With Other Color Knob (See Knob Table) ■			SKS42■	SKS43■	SKS44■	SKS45■	SKS46■	SKS47■	SKS49■	SKS401■	SKS402■	35.10
With Contact Block(s)												
With Standard Black Knob (From Table for Other Colors, Replace B in Type Number with Color Code)			SKS42BH13	SKS43BH13	SKS44BH13	SKS45BH13	SKS46BH13	SKS47BH13	SKS49BH13	SKS401BH13	SKS402BH13	64.00
With 1 KA1 on side #2			SKS42BH1	SKS43BH1	SKS44BH1	SKS45BH1	SKS46BH1	SKS47BH1	SKS49BH1	SKS401BH1	SKS402BH1	64.00
With 1 KA1 on side #1			SKS42BH2	SKS43BH2	SKS44BH2	SKS45BH2	SKS46BH2	SKS47BH2	SKS49BH2	SKS401BH2	SKS402BH2	92.00
With 1 KA1 on side #1 and 1 KA1 on side #2 (H2)												
Spring Return from Left to Center Operator Only ▲												
Without Knob			SKS62	SKS63	SKS64	SKS65	SKS66	SKS67	SKS69	SKS601	SKS602	47.60
With Standard Black Knob			SKS62B	SKS63B	SKS64B	SKS65B	SKS66B	SKS67B	SKS69B	SKS601B	SKS602B	54.00
With Other Color Knob (See Knob Table) ■			SKS62■	SKS63■	SKS64■	SKS65■	SKS66■	SKS67■	SKS69■	SKS601■	SKS602■	54.00
Spring Return From Right to Center Operator Only ▲												
Without Knob			SKS72	SKS73	SKS74	SKS75	SKS76	SKS77	SKS79	SKS701	SKS702	47.60
With Standard Black Knob			SKS72B	SKS73B	SKS74B	SKS75B	SKS76B	SKS77B	SKS79B	SKS701B	SKS702B	54.00
With Other Color Knob (See Knob Table) ■			SKS72■	SKS73■	SKS74■	SKS75■	SKS76■	SKS77■	SKS79■	SKS701■	SKS702■	54.00
Spring Return Both Sides to Center Operator Only ▲												
Without Knob			SKS52	SKS53	SKS54	SKS55	SKS56	SKS57	SKS59	SKS501	SKS502	47.60
With Standard Black Knob			SKS52B	SKS53B	SKS54B	SKS55B	SKS56B	SKS57B	SKS59B	SKS501B	SKS502B	54.00
With Other Color Knob (See Knob Table) ■			SKS52■	SKS53■	SKS54■	SKS55■	SKS56■	SKS57■	SKS59■	SKS501■	SKS502■	54.00

▲ These operators can be ordered complete with contact blocks. For maximum block usage, see page 17-85. Add the "H" number chosen from page 17-80 to the end of the operator type number and add the cost of the "H" number to the operator cost.  
■ Add the color code as chosen from knob color table below.  
**EXAMPLE: SKS43■ with a green gloved-hand knob = SKS43FG.**

**Selector Switch Knobs**

Standard Knob		Gloved-Hand Knob		Coin Operated		Price
Color	Knob Code	Knob Code	Type	Knob Code	Type	
Black	B	B11	B25	TB	B18	\$6.60
Red	R	R8	R24	TR	R16	
Green	G	G8	G24	TG	G16	
Yellow	Y	Y8	Y24	TY	Y16	
Orange	S	S11	S25	TL	L16	
Blue	L	L8	L24	TL	L16	
White	W	W8	W24	WL	W16	
Amber	A	A8	A24	AL	A16	
Clear	C	C8	C24	CL	C16	

For additional information, reference Catalog #9001CT0001.

# Push Buttons—Class 9001 Type SK—30 mm

## Corrosion Resistant Selector Switches

### Illuminated 3 Position Selector Switch Operators—UL Types 4, 4X, 13/NEMA 4, 4X, 13

For use in hazardous locations—See page 17-79.  
Legend plate and contact block not included unless noted.

CONTACT BLOCK REQUIRED				1—Contact Closed 0—Contact Open																											
Contact Block Position	Quantity and Type	Mount on Side	Center		Center		Center		Center		Center		Center		Center																
			Left	Right	Left	Right	Left	Right	Left	Right	Left	Right	Left	Right	Left	Right															
<p>Top View</p>	KA1	or	KA1 #2	KA3 #2	1	0	0	1	0	0	0	0	1	1	0	0	1	0	0	1	0	0	0	1	0	1	1	0			
	KA2			KA3 #2	0	1	1	0	0	1	0	1	0	0	1	0	0	0	1	0	1	1	0	1	1	1	0	0	0	0	1
	KA1	or	KA1 #1	KA3 #1	0	0	1	1	0	0	0	0	1	1	0	0	0	1	0	0	0	1	1	0	1	0	0	1	0	1	1
	KA2			KA3 #1	1	1	0	0	0	1	0	1	0	0	0	1	1	0	0	0	1	0	0	1	0	1	0	0	1	0	0
Cam (see page 17-64)				B	C	D	E	F	G	J	L	M																			
Illuminated Operators				Type	Type	Type	Type	Type	Type	Type	Type	Type	Type	Type	Price																
Manual Return ▲ Without Knob, 110–120 V 50–60 Hz Transformer				SK42J1	SK43J1	SK44J1	SK45J1	SK46J1	SK47J1	SK49J1	SK401J1	SK402J1	\$105.																		
With Standard Red Knob, 110–120 V 50–60 Hz Transformer				SK42J1R	SK43J1R	SK44J1R	SK45J1R	SK46J1R	SK47J1R	SK49J1R	SK401J1R	SK402J1R	111.																		
Without Knob and Other Voltage Transformer, Flashing or LED ★				SK42J	SK43J	SK44J	SK45J	SK46J	SK47J	SK49J	SK401J	SK402J	86.																		
Without Knob, Full Voltage Neon or Resistor ▼				SK42J	SK43J	SK44J	SK45J	SK46J	SK47J	SK49J	SK401J	SK402J	111.																		
With Other Color Knob and Transformer, Flashing or LED ★				SK42J◆	SK43J◆	SK44J◆	SK45J◆	SK46J◆	SK47J◆	SK49J◆	SK401J◆	SK402J◆	111.																		
With Other Color Knob, Full Voltage Neon or Resistor ▼				SK42J◆	SK43J◆	SK44J◆	SK45J◆	SK46J◆	SK47J◆	SK49J◆	SK401J◆	SK402J◆	92.																		
Spring Return Left To Center ▲ Without Knob, 110–120 V 50–60 Hz Transformer				SK62J1	SK63J1	SK64J1	SK65J1	SK66J1	SK67J1	SK69J1	SK601J1	SK602J1	123.																		
With Standard Red Knob, 110–120 V 50–60 Hz Transformer				SK62J1R	SK63J1R	SK64J1R	SK65J1R	SK66J1R	SK67J1R	SK69J1R	SK601J1R	SK602J1R	131.																		
Without Knob and Other Voltage Transformer, Flashing or LED ★				SK62J	SK63J	SK64J	SK65J	SK66J	SK67J	SK69J	SK601J	SK602J	123.																		
Without Knob, Full Voltage Neon or Resistor ▼				SK62J	SK63J	SK64J	SK65J	SK66J	SK67J	SK69J	SK601J	SK602J	105.																		
With Other Color Knob and Transformer, Flashing or LED ★				SK62J◆	SK63J◆	SK64J◆	SK65J◆	SK66J◆	SK67J◆	SK69J◆	SK601J◆	SK602J◆	131.																		
With Other Color Knob, Full Voltage Neon or Resistor ▼				SK62J◆	SK63J◆	SK64J◆	SK65J◆	SK66J◆	SK67J◆	SK69J◆	SK601J◆	SK602J◆	111.																		
Spring Return Right To Center ▲ Without Knob, 110–120 V 50–60 Hz Transformer				SK72J1	SK73J1	SK74J1	SK75J1	SK76J1	SK77J1	SK79J1	SK701J1	SK702J1	123.																		
With Standard Red Knob, 110–120 V 50–60 Hz Transformer				SK72J1R	SK73J1R	SK74J1R	SK75J1R	SK76J1R	SK77J1R	SK79J1R	SK701J1R	SK702J1R	131.																		
Without Knob and Other Voltage Transformer, Flashing or LED ★				SK72J	SK73J	SK74J	SK75J	SK76J	SK77J	SK79J	SK701J	SK702J	123.																		
Without Knob, Full Voltage Neon or Resistor ▼				SK72J	SK73J	SK74J	SK75J	SK76J	SK77J	SK79J	SK701J	SK702J	105.																		
With Other Color Knob and Transformer, Flashing or LED ★				SK72J◆	SK73J◆	SK74J◆	SK75J◆	SK76J◆	SK77J◆	SK79J◆	SK701J◆	SK702J◆	131.																		
With Other Color Knob, Full Voltage Neon or Resistor ▼				SK72J◆	SK73J◆	SK74J◆	SK75J◆	SK76J◆	SK77J◆	SK79J◆	SK701J◆	SK702J◆	111.																		
Spring Return Both Sides To Center ▲ Without Knob, 110–120 V 50–60 Hz Transformer				SK52J1	SK53J1	SK54J1	SK55J1	SK56J1	SK57J1	SK59J1	SK501J1	SK502J1	123.																		
With Standard Red Knob, 110–120 V 50–60 Hz Transformer				SK52J1R	SK53J1R	SK54J1R	SK55J1R	SK56J1R	SK57J1R	SK59J1R	SK501J1R	SK502J1R	131.																		
Without Knob and Other Voltage Transformer, Flashing or LED ★				SK52J	SK53J	SK54J	SK55J	SK56J	SK57J	SK59J	SK501J	SK502J	123.																		
Without Knob, Full Voltage Neon or Resistor ▼				SK52J	SK53J	SK54J	SK55J	SK56J	SK57J	SK59J	SK501J	SK502J	105.																		
With Other Color Knob and Transformer, Flashing or LED ★				SK52J◆	SK53J◆	SK54J◆	SK55J◆	SK56J◆	SK57J◆	SK59J◆	SK501J◆	SK502J◆	131.																		
With Other Color Knob, Full Voltage Neon or Resistor ▼				SK52J◆	SK53J◆	SK54J◆	SK55J◆	SK56J◆	SK57J◆	SK59J◆	SK501J◆	SK502J◆	111.																		

- ▲ These operators can be ordered complete with contact blocks. For maximum block usage, see page 17-85. Add the "H" number chosen from page 17-80 to the end of the operator type number and add the cost of the "H" number to the operator cost.
- Add the voltage assembly code as chosen from table on page 17-77.  
EXAMPLE: SK43J with 60 Vac/dc = SK43J37.
- ◆ Add the color as chosen from knob color table on page 17-75.  
EXAMPLE: SK43J35◆ with a green gloved-hand knob = SK43J35FG.
- ★ The knob must be the same color as the LED light module chosen, e.g., for red LED, use red knob.
- ▼ On neon light modules, use clear knobs only.

### Two Color Selector Switch

Used to indicate red in left position and green in right position on illuminated operators.

Knob	Factory Assembled Form Number△	Price Adder
Standard	Y178	\$19.
Gloved-Hand	Y1781	19.

△ Add form number to standard Type number, e.g., Type SK43J1 Form Y178.

Light Modules	page 17-77
Contact Blocks	page 17-78
H Contact Block Assembly Codes	page 17-80
Legend Plates	page 17-81
Accessories	page 17-83
Replacement Parts	page 17-86

For additional information, reference Catalog #9001CT0001.

**Non-Illuminated 4 Position Selector Switch Operators—  
UL Types 4, 4X, 13/NEMA 4, 4X, 13**

For use in hazardous locations—See page 17-79.  
Legend plate and contact block not included unless noted.

CONTACT BLOCK REQUIRED				1 — Contact Closed 0 — Contact Open	
Contact Block Position	Quantity and Type	Mount on Side			
<p>Top View</p>	KA1	KA3	KA1 #2	KA3 #2	1 0 0 0
	KA2	KA3	KA1 #2	KA2 #2	0 0 1 0
	KA1	KA3	KA1 #1	KA3 #1	0 0 0 1
	KA2	KA3	KA1 #1	KA2 #1	0 1 0 0

Non-Illuminated Operators	Cam (see page 17-64)	Type	Price
Manual Return Operator Only ▲ Without Knob With Standard Black Knob With Other Color Knob (See Knob Table) ■	H H H	SKS88 SKS88B SKS88■	\$28.50 35.10 35.10
Spring Return From Left, Spring Return From Right, Maintained in the Two Mid Positions Operator Only ▲ Without Knob With Standard Black Knob With Other Color Knob (See Knob Table) ■	H H H	SKS89 SKS89B SKS89■	47.60 54.00 54.00

Illuminated Operators				
Manual Return ▲ Without Knob, 110-120 V 50-60 Hz Transformer With Standard Red Knob, 110-120 V 50-60 Hz Transformer Without Knob and With Other Voltage Transformer, Flashing or LED ★ Without Knob, Full Voltage Neon or Resistor ▼ With Other Color Knob and Transformer, Flashing or LED ★ With Other Color Knob, Full Voltage Neon or Resistor ▼	H H H H H H	SK88J1 SK88J1R SK88J◆ SK88J◆ SK88J◆◆ SK88J◆◆	105.00 111.00 105.00 86.00 111.00 92.00	
Spring Return From Left, Spring Return From Right, Maintained in the Two Mid Positions Operator Only ▲ Without Knob, 110-120 V 50-60 Hz Transformer With Standard Red Knob, 110-120 V 50-60 Hz Transformer Without Knob and Other Voltage Transformer, Flashing or LED ★ Without Knob, Full Voltage Neon or Resistor ▼ With Other Color Knob and Transformer, Flashing or LED ★ With Other Color Knob, Full Voltage Neon or Resistor ▼	H H H H H H	SK89J1 SK89J1R SK89J◆ SK89J◆ SK89J◆◆ SK89J◆◆	123.00 131.00 123.00 105.00 131.00 111.00	

- ▲ These operators can be ordered complete with contact blocks. For maximum block usage, see page 17-85. Add the "H" number chosen from page 17-80 to the end of the operator type number and add the cost of the "H" number to the operator cost.
- Add the color code as chosen from knob color table below.
- ◆ EXAMPLE: SKS88■ with a green gloved-hand knob = SKS88FG.
- ◆ Add the LED assembly code as chosen from table on page 17-77.
- ◆ EXAMPLE: SK88J◆ with 60 Vac/dc = SK88J37.
- ★ The knob must be the same color as the LED light module chosen, e.g., for red LED, use red knob.
- ▼ On neon light modules, use clear knobs only.

**Potentiometer (with Dial Plate) ◇**

Watts		Description		Type		Price		
2		Operator only—Single Pot		SK20		\$134.		
		Operator with Single Pot		SK21 ▲		191.		
		Operator only—Tandem Pot		SK22		209.		
		Operator with Tandem Pot		SK23 □		266.		
▲ For complete Type number add suffix number from table below. Example: Type SK2105 □ For complete Type number add suffix number from table below. Example: Type SK2305								
Suffix ▲	Ohms	Suffix ▲	Ohms	Suffix ▲	Ohms	Ohms		
						Front	Rear	
01	50k	07	5000	13	500k	82	1000	1000
02	100k	08	10k	37	750k	83	5000	5000
38	200k	40	15k	14	1.0M	85	10k	10k
03	250k	09	25k	15	2.5M	88	50k	50k
04	500k	35	35k	16	5.0M	89	100k	100k
05	1000k	10	50k	17 ★	5.0M			
32	1500k	36	75k					
39	2000k	11	100k					
06	2500k	12	250k					
33	3500k							

◇ The dial plate only catalog number is 651580018003—\$2.90.  
★ For use with Class 9050 Type T.

**Selector Switch Knobs**

Standard Knob		Gloved-Hand Knob		Coin Operated		Price	
Color	Knob Code	Type	Knob Code	Type	Knob Code	Type	Price
Black ▼	B	B11	FB	B25	TB	B18	\$6.60
Red	R	R8	FR	R24	TR	R16	
Green	G	G8	FG	G24	TR	G16	
Yellow	Y	Y8	FY	Y24	TG	Y16	
Orange ▼	S	S11	FS	S25	TY	Y16	
Blue	L	L8	FL	L24	TL	L16	
White	W	W8	FW	W24	TL	TL	
Amber	A	A8	FA	A24	TC	TC	
Clear	C	C8	FC	C24	TC	C16	

▼ Black and orange are opaque and for use on non-illuminated operators only.





For additional information, reference Catalog #9001CT0001.

# Push Buttons—Class 9001 Type SK—30 mm

## Corrosion Resistant Pilot Lights

### Pilot Lights—UL Types 4, 4X, 13/NEMA 4, 4X, 13

For use in hazardous locations—See page 17-79.  
Legend plate not included.

Description		Voltage	Style	With Red Fresnel Color Cap	With Green Fresnel Color Cap	With Other Color Cap	Price	Without Color Cap	Price	
 9001SKP1	Standard Pilot Light (Non-metallic fresnel color cap shown)	110–120 V, 50–60 Hz	Transformer	SKP1R31	SKP1G31	SKP1■	\$102.	SKP1	\$95.	
		220–240 V, 50–60 Hz	Transformer	SKP7R31	SKP7G31	SKP7■	102.	SKP7	95.	
		24–28 Vac/dc	Full Voltage	SKP35R31	SKP35G31	SKP35■	83.	SKP35	77.	
		For other voltages see Table ▲	Transformer, Flashing or LED♦	SKP▲R31	SKP▲G31	SKP▲■	102.	SKP▲	95.	
 9001SKT1	Push-To-Test Pilot Light (Non-metallic fresnel color cap shown)	110–120 V, 50–60 Hz	Transformer	SKT1R31	SKT1G31	SKT1■	131.	SKT1	123.	
		220–240 V, 50–60 Hz	Transformer	SKT7R31	SKT7G31	SKT7■	131.	SKT7	123.	
		24–28 Vac/dc	Full Voltage	SKT35R31	SKT35G31	SKT35■	111.	SKT35	105.	
		For other voltages see Table ▲	Transformer, Flashing or LED♦	SKT▲R31	SKT▲G31	SKT▲■	131.	SKT▲	123.	
 9001SKTR38	Remote Test Pilot Light (Non-metallic fresnel color cap shown)	120 Vac Only	Resistor	SKTR38R31	SKTR38G31	SKTR38■	131.	SKTR38	123.	
		24–28 Vac Only	Full Voltage	SKTR35R31	SKTR35G31	SKTR35■	131.	SKTR35	123.	
		For other voltages see Tables ▲▲▼	Full Voltage or Resistor ▼	SKTR▲R31	SKTR▲G31	SKTR▲■	131.	SKTR▲	123.	
 Pilot Light For Intrinsically Safe Circuits (NEMA 4X)	Intrinsically safe equipment must not release electrical or thermal energy capable of igniting certain explosive or combustible hazardous atmospheres, for which the equipment has been tested. These pilot lights are intrinsically safe when used with suitable approved barrier or barrier relay. These pilot lights are Factory Mutual (FM) approved. Consult your local Square D sales office for further details. These pilot lights are fully encapsulated—there are no replaceable parts—except for the SK40 ring nut. Use KN100 series plastic legend plates as shown on Pages 17-81 and 17-82.	Operating Voltage Range	Nominal Current	V max = 32 V I max = 165 mA	KP44R	KP44G	KP44Y (Yellow Color Cap)	119.	...	...
		20–30 Vac/dc	25 mA							

- ▲ Add the voltage assembly code as chosen from table, page 17-77.  
**EXAMPLE: SKT▲R31 with 60 Vac red LED voltage = SKT37LRR31.**
- Add the color code as chosen from the color cap table below.  
**EXAMPLE: SKP1■ with a blue fresnel cap = SKP1L31.**
- ♦ The cap must be the same color as the LED light module chosen, e.g., for green LED, use green color cap.
- ★ On neon light modules, use clear color caps only.
- ▼ Use only full voltage or resistor voltage assembly codes on remote test pilot lights. Do not choose LED, neon or transformer codes. For AC use only.

#### Color Caps

Color	■ Plastic Fresnel	■ Plastic Domed
Amber	A31	A9
Blue	L31	L9
Clear	C31	C9
Green	G31	G9
Red	R31	R9
White	W31	W9
Yellow	Y31	Y9

#### Typical Wiring Diagram

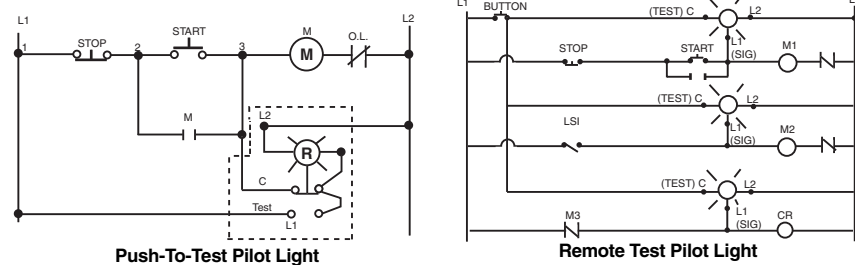

Light Modules .....page 17-77  
Contact Blocks.....page 17-78  
H Contact Block Assembly Codes .....page 17-80  
Legend Plates .....page 17-81  
Accessories .....page 17-83  
Replacement Parts .....page 17-86

For additional information, reference Catalog #9001CT0001.

**Standard Light Modules for Types K, SK, and KX Control Units ★**

For use in hazardous locations—See page 17-79.

- Neon type light modules—use CLEAR color caps only.
- LED light modules require that the color cap and the LED be the same color, or use a clear color cap.



Voltage	Description	For Use With Single Lamp III. Operators as Indicated ▲	Light Module Type †	Price of Light Module	Voltage Assembly Code	Rating	Replacement Lamp Part Number † ‡	Price of Replacement Lamp
6 Vac/dc	Full Voltage	All	KM31	\$57.	31	.9 VA	2550101020	\$8.30
12–14 Vac/dc	Full Voltage	All	KM32	57.	32	1.2 VA	2550101037	8.30
18 Vac/dc	Resistor	All	KM33	57.	33	1.4 VA	2550101037	8.30
24–28 Vac/dc	Full Voltage	All	KM35	57.	35	1.2 VA	2550101002	8.30
24–28 Vac/dc	LED Red	All Except ■	KM35LR	77.	35LR	.28 VA	6508805210	28.50
24–28 Vac/dc	LED Green	All Except ■	KM35LG	77.	35LG	.28 VA	6508805212	28.50
24–28 Vac/dc	LED Yellow	All Except ■	KM35LY	77.	35LY	.28 VA	6508805211	28.50
24–28 Vac/dc	LED White	All Except ■	KM35LW	77.	35LW	.28 VA	6508805214	28.50
24–28 Vac/dc	LED Blue	All Except ■	KM35LL	77.	35LL	.28 VA	6508805213	28.50
48 Vac/dc	Full Voltage	All	KM36	57.	36	2.6 VA	2550101025	8.30
110–120 V, 50–60 Hz	Transformer	All Except ■	KM1	77.	1	2.4 VA	2550101020	8.30
110–120 V, 50–60 Hz	Flashing	All Except ■	KMF1	77.	F1	.85 VA	2550101036	11.00
120 Vac/dc	Resistor	All	KM38	57.	38	3.0 VA	2550101027	8.30
120 Vac/dc	Full Voltage	All	KM38	57.	38	3.0 VA	2550101027	8.30
120 Vac/dc	Neon	All Except ■	KM11	57.	11	0.2 VA	2550101013	21.90
120 Vac/dc	LED Red	All Except ■	KM38LR	77.	38LR	1.4 VA	6508805210	28.50
120 Vac/dc	LED Green	All Except ■	KM38LG	77.	38LG	1.4 VA	6508805212	28.50
120 Vac/dc	LED Yellow	All Except ■	KM38LY	77.	38LY	1.4 VA	6508805211	28.50
120 Vac/dc	LED White	All Except ■	KM38LW	77.	38LW	1.4 VA	6508805214	28.50
120 Vac/dc	LED Blue	All Except ■	KM38LL	77.	38LL	1.4 VA	6508805213	28.50
208–220 V, 50–60 Hz	Transformer	All Except ■	KM3	77.	3	2.5 VA	2550101020	8.30
220–240 V, 50–60 Hz	Transformer	All Except ■	KM7	77.	7	2.0 VA	2550101020	8.30
240 Vac/dc	Resistor	All Except ■	KM25	57.	25	6.0 VA	2550101027	8.30
240 Vac/dc	Neon	All Except ■ and KX	KM12	57.	12	0.3 VA	2550101013	21.90
277 V, 50–60 Hz	Transformer	All Except ■	KM8	77.	8	2.4 VA	2550101020	8.30
380–480 V, 50–60 Hz	Transformer	All Except ■	KM5	77.	5	2.8 VA	2550101020	8.30
480 Vac/dc	Neon	All Except ■ and KX	KM14	57.	14	0.5 VA	2550101013	21.90
550–600 V, 50–60 Hz	Transformer	All Except ■	KM6	77.	6	2.5 VA	2550101020	8.30

**Note:** Standard light modules are available in other voltages. Contact your nearest Square D/Schneider Electric sales office for details.

**Shallow Depth Light Modules For Types K and SK Control Units ★**

For use in hazardous locations—See page 17-79. Reduces the depth of illuminated push buttons with contact blocks by over 33%.



Voltage	Description	Light Module Type †	Price of Light Module	Voltage Assembly Code	Rating	Replacement Lamp Part Number †	Price of Replacement Lamp
24–28 Vac/dc	Full Voltage	KM55	\$57.	55	1.2 VA	2550101002	\$8.30
110–120 Vac/dc	Full Voltage	KM58	57.	58	3.0 VA	2550101027	8.30

- ▲ 9001K, SK, KX.
- Do not use on any remote test version pilot light.
- ◆ All light modules with an LED above 12 V use a 14 V bipolar LED.
- ★ For use with all operators except KX and remote test pilot.
- ▼ Check light module label for series and replacement number.



File E42259  
CCN NKCR



File LR25490  
Class 3211 03



marked

For additional information, reference Catalog #9001CT0001.

# Push Buttons—Class 9001 Type K, SK and KX—30 mm

Type K, SK and KX—30 mm

Class 9001





www.SquareD.com



For the most up-to-date information

The Class 9001 Type KA contact blocks are FINGERSAFE® contact blocks (meeting VDE 0106 Part 100). They have one screw mounting and captive (backed out) plus/minus terminal screws. These contact blocks are double-break, direct-acting contacts. Because of the wiping action of these contacts, they are suitable for use with programmable controllers. All contact blocks listed below accept up to 2 #12–#24 AWG solid or stranded wires. Recommended tightening torque for screw terminals is 7 in-lbs.





### Standard Contact Blocks

Description	Symbol	Type	Price
 (Clear Cover)	 Direct-Acting	KA1	\$28.50
 (Green Cover)		KA2	14.30
 (Red Cover)	 Direct-Acting	KA3	14.30
 (Clear Cover)	 N.O. Contact Early Closing	KA4	28.50
 (Red Cover)	 N.C. Contact Late Opening	KA5	14.30
 (Green Cover)	 N.O. Contact Early Closing	KA6	14.30

### Additional Circuit Arrangements Available

Sequencing ▲ N.O. Contact of KA4 closes before N.O. Contact on KA1		Order One Type KA4 and One Type KA1	\$57.00
Overlapping ▲ N.O. Contact of KA4 closes before N.C. Contact of KA5 Opens		Order One Type KA4 and One Type KA5	42.80

▲ For push buttons or two-position selector switches only. For sequencing or overlapping contacts on other operators, consult your nearest Square D/Schneider Electric sales office.





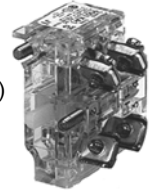

Symbol	Contact Blocks with Binder Head Screws (not FINGERSAFE)		Price	Gold Flashed Contacts with Standard Pressure Wire Terminals	
	Type	Quantity ■		Type	Price
	KA21	25-Up	\$28.50	KA31	\$47.60
	KA22	25-Up	14.30	KA32	23.70
	KA23	25-Up	14.30	KA33	23.70
 N.O. Early Closing	KA24	25-Up	28.50	KA34	47.60
 N.C. Contact Late Opening	KA25	25-Up	14.30	KA35	23.70

■ Minimum order quantity is 25. The price represents one individual contact block.



Contact blocks listed below are not FINGERSAFE, but provide:

- Terminals that accept ring tongue/fork tongue connectors
- Short single circuit contact blocks (0.75" deep vs. 0.97" deep on the FINGERSAFE)
- Same as old style Series G product available prior to March, 1989.
- Use form Y238 (add to catalog # as suffix— Example: 9001KRU1H13Y238)



Symbol	Type	Price	Symbol	Type	Price
	KA1G	\$28.50	 N.O. Contact Early Closing	KA4G	\$28.50
	KA2G	14.30	 N.C. Contact Late Opening	KA5G	14.30
	KA3G	14.30	 N.O. Contact Early Closing	KA6G	14.30

Contact blocks listed below are not FINGERSAFE, but have Quick-Connect terminals.

Symbol	Type	Price
	KA12	\$23.70
	KA13	23.70

Dimensions ..... Catalog 9001CT0001

### Maximum Current Ratings For Control Circuit Contacts—Types KA1–KA6, KA21–25, KA31–35, KA1G–KA6G

Volts	AC					Resistive 75% Power Factor Make, Break and Continuous Amperes	Volts	DC				
	Inductive (NEMA / UL Type A600) 35% Power Factor							Inductive and Resistive (NEMA Q600)				
	Make		Break		Continuous Carrying Amperes			Make and Break				Continuous Carrying Amperes
	Amperes	VA	Amperes	VA				KA1	KA2 KA3	KA4	KA5 KA6	
120	60	7200	6.0	720	10	10	125	0.55	0.55	...	...	2.5
240	30	7200	3.0	720	10	10	250	0.27	0.27	...	...	2.5
480	15	7200	1.5	720	10	10	600	0.10	0.10	...	...	2.5
600	12	7200	1.2	720	10	10						

For additional information, reference Catalog #9001CT0001.

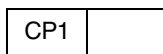

Discount Schedule

Hazardous locations do not always require the use of explosion-proof equipment like the Class 9001 Type BR control stations. Selecting the most appropriate device for the location can save you money. For more information on the types of hazardous locations, contact your local electrical inspector. The table below shows the Square D offering according to class, division and group.

For			Use
Class	Division	Group(s)	
I	1	A	1. Intrinsically Safe System
I	1	B, C, D	1. 9001 BR station 2. Intrinsically Safe System
I	2	A	1. 9001 K, SK, KX control stations with restrictions▲ 2. Intrinsically Safe System
I	2	B, C, D	1. 9001 BR station 2. 9001 K, SK, KX control stations with restrictions▲ 3. Intrinsically Safe System
II	1	E, F, G	1. 9001 BR station 2. Intrinsically Safe System
II	2	E, F	1. 9001 BR station 2. 9001 K, SK, KX control stations with restrictions▲ 3. Intrinsically Safe System
II	2	G	1. 9001 BR station 2. 9001 K, SK, KX control stations with restrictions■ 3. Intrinsically Safe System
III	1, 2	...	1. 9001 BR Station 2. 9001 K, SK, KX control stations with restrictions■ 3. Intrinsically Safe System

- ▲ Any Class 9001 Type K, SK or KX operator can be used in an area classified as Class I, Division 2 hazardous locations, if:
1. Only logic (KA40 series) or power (KA50 series) reed contact blocks are used.
  2. All Type K and SK illuminated operators are UL approved for use in Class I Division 2 areas.◆
  3. Type KX illuminated operators do not use 4 lamp light modules, or 2 lamp light modules other than the transformer type.◆
  4. The operators are mounted in any NEMA 4 & 13 enclosures.
- Any Class 9001 Type K, SK, or KX operator mounted in a Class 9001 Type KY, KYSS, KYAF, SKY enclosure may be used, except potentiometer operators.
- ◆ Add Form Y243 to single lamp Push-To-Test pilot lights.
- For ▲ and ■: UL Listed: File E10054(N), CCN NOIV.

**Dimensions When Using Contact Blocks**

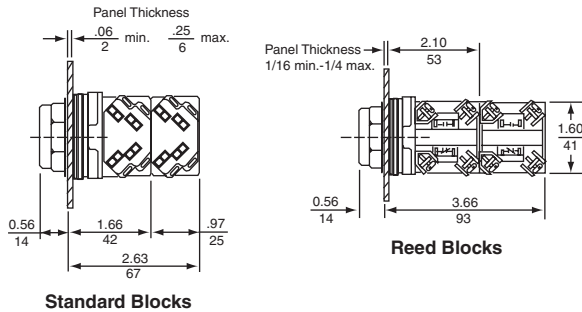

All contact blocks listed below accept #12–18 solid or stranded wire.

**Hermetically Sealed Logic Reed Contact Blocks▲**  
Suitable for use on low energy level circuits

Description	Symbol	Type	Price
		KA41	\$57.00
		KA42	28.50
		KA43	28.50
		KA44	57.00
		KA45	57.00

Max. Volts AC/DC	Maximum Load		
	Resistive	Inductive	Continuous
32/30	.25 A	.10 A	.5 A
120/100	8 VA	3 VA	.5 A

The maximum number of logic and/or power reed contact blocks per operator is as indicated on individual selection tables for standard contact blocks, **except**:

- On 3 position selector switches with cams C, D, E, F, G, L, or M, mount reed blocks on **one side only** (either side), maximum 2 in tandem.
- On 4 position selector switches, mount reed blocks on **one side only** (either side), maximum 2 in tandem.
- On joysticks or on Type KR8 or SKR8 push-pull operators, mount reed blocks on **one side only** (either side), maximum 2 in tandem.

**Hermetically Sealed Power Reed Contact Blocks▲**

Description	Symbol	Type	Price
		KA51	\$95.
		KA52	67.
		KA53	67.
		KA54	95.
		KA55	95.

Volts	AC NEMA C300 ★				
	Make		Break		Continuous Carrying Amps
	Amps	VA	Amps	VA	
120	10.00	1200	1.000	120	3.0
240	5.00	1200	.500	120	3.0

Volts	DC NEMA Q150 ▼				
	Make		Break		Continuous Carrying Amps
	Amps	VA	Amps	VA	
115	.50	58	.50	58	3.0

The power reed contact blocks can be used with standard industrial relays and starters through NEMA Size 4. Minimum voltage is 5 V and the minimum current is 1 mA.  
 ★ Inductive Rating—35% Power Factor.  
 ▼ Inductive and Resistive Ratings  
 ▲ Not for use in pendant stations.

For additional information, reference Catalog #9001CT0001.

# Push Buttons—Class 9001 Type K, SK and KX—30 mm

## Contact Block “H” Numbers

The design of the Class 9001 Type KA contact blocks allows them to be mounted side by side and/or in tandem.

The system described below enables you to specify an operator and a particular arrangement of contact blocks with a single Type number. Operators and contact blocks are shipped completely assembled.

**EXAMPLE:** A Type KR1B push button with 2 Type KA1 contact blocks would be Class 9001 Type KR1BH2.



Suffix No. (Add to Operator Type)	Price	Positions					
		1	2	3	4	5	6
H1	\$28.50	KA1					
H2	57.00	KA1	KA1				
H3	86.00	KA1	KA1	KA1			
H4	114.00	KA1	KA1	KA1	KA1		
H5	14.30	KA2					
H6	14.30	KA3					
H7	28.50	KA2	KA2				
H8	28.50	KA3	KA3				
H9	57.00	KA4	KA1				
H10	42.80	KA4	KA5				
H11	86.00	KA1	KA1		KA1		
H12	57.00	KA2	KA3	KA2	KA3		
H13	28.50		KA1				
H14	14.30		KA3				
H15	42.80	KA2	KA3	KA2			
H16	42.80	KA2	KA3		KA3		
H17	71.00	KA1	KA1	KA2	KA3		
H18	71.00	KA3	KA1	KA3		KA3	
H19	143.00	KA1	KA1	KA1	KA1	KA1	
H21	28.50	KA2	KA3				
H23	171.00	KA1	KA1	KA1	KA1	KA1	KA1
H24	42.80	KA1	KA2				
H25	28.50	KA5	KA3				
H26	86.00	KA1	KA1	KA4			
H27	42.80	KA3	KA3	KA3			
H28	42.80	KA1	KA3		KA5	KA1	KA3
H29	143.00	KA1	KA4	KA1	KA5	KA1	
H31	57.00	KA2	KA2	KA1			
H32	57.00		KA1		KA1		
H33	57.00	KA1	KA3	KA3			
H34	42.80	KA5					
H36	14.30	KA1	KA2				
H37	28.50	KA3	KA2				
H38	57.00	KA3	KA2	KA3	KA2		
H39	57.00	KA5	KA1		KA3		
H40	86.00	KA1	KA1		KA4		
H41	42.80	KA3	KA2		KA2		
H42	86.00	KA1	KA1	KA2	KA2		
H43	42.80	KA2	KA2	KA2			
H44	42.80	KA3	KA2		KA3		
H45	71.00	KA1	KA2	KA3	KA2		KA3
H46	42.80	KA2	KA2		KA2		
H47	86.00	KA5	KA3	KA3	KA5	KA3	KA3
H48	114.00	KA1	KA1	KA4	KA4		
H50	59.00	KA5	KA3	KA3	KA3		
H51	59.00	KA5	KA3		KA4		
H52	59.00	KA3	KA1	KA3			
H53	42.80	KA4	KA2				
H54	59.00	KA4	KA5	KA2			
H55	86.00	KA1	KA2	KA2		KA1	
H56	59.00	KA2	KA2	KA2	KA2		
H57	42.80	KA5	KA4				
H58	14.30		KA5				
H59	71.00	KA1	KA2	KA1			
H60	86.00	KA1	KA2	KA1		KA3	
H61	59.00	KA2	KA2	KA5	KA5		
H62	59.00	KA1	KA2	KA3			
H63	42.80	KA1		KA3			
H64	42.80	KA3	KA2	KA2			
H66	86.00	KA3	KA1	KA3	KA1		
H71	59.00	KA3	KA3	KA3	KA3		
H72	28.50	KA3	KA5				
H73	71.00	KA1	KA1	KA3			
H74	71.00	KA1	KA2	KA5	KA5		
H75	86.00	KA1	KA3	KA3	KA3	KA3	
H76	86.00	KA1	KA2	KA2	KA2	KA2	
H77	59.00	KA1	KA1				
H78	59.00	KA1	KA2		KA5		
H79	42.80	KA3	KA3		KA5		
H80	86.00	KA4	KA4	KA5	KA5		
H81	86.00	KA1	KA1	KA2	KA3		
H82	95.00	KA12	KA12	KA13	KA13		
H83	47.60	KA35	KA35				
H86	42.80	KA3	KA2	KA3	KA2		
H87	71.00	KA3	KA2	KA3	KA2	KA3	

Suffix No. (Add to Operator Type)	Price	Positions					
		1	2	3	4	5	6
H89	\$ 42.80	KA3	KA1				
H90	100.00	KA1	KA1	KA3	KA2	KA3	
H91	86.00	KA1	KA2	KA1	KA2		
H92	86.00	KA1	KA2	KA3	KA2	KA3	KA3
H93	86.00	KA3	KA2	KA3	KA5	KA5	KA3
H94	128.00	KA1	KA1	KA1	KA3	KA3	KA3
H95	42.80	KA2	KA1				
H97	59.00	KA1	KA3		KA2		
H98	114.00	KA1	KA1	KA1	KA2	KA2	KA2
H99	71.00	KA2	KA2	KA2	KA2	KA2	KA2
H100	86.00	KA1	KA3	KA1	KA2		
H101	86.00	KA2	KA2	KA2	KA2		KA2
H102	59.00	KA1	KA3		KA3		
H103	86.00	KA1	KA1	KA3	KA3		
H104	128.00	KA1	KA1	KA1	KA2	KA2	KA2
H105	47.60	KA31					
H106	95.00	KA31	KA31				
H107	43.50	KA3	KA2				
H109	43.50	KA3	KA3	KA5			
H110	86.00	KA3	KA3	KA3	KA3	KA3	KA3
H111	100.00	KA4	KA4	KA4	KA5		
H112	47.60	KA33	KA33				
H113	71.00	KA1	KA1	KA5			
H114	28.50	KA21					
H115	71.00	KA3	KA1	KA5	KA3		
H116	71.00	KA3	KA1	KA3	KA2		
H117	86.00	KA2	KA3	KA1	KA2	KA2	KA2
H118	42.80	KA1	KA5				
H119	86.00	KA1	KA1	KA5	KA3		
H120	57.00	KA3	KA4	KA3			
H121	57.00	KA3	KA3	KA3	KA5	KA5	KA3
H122	57.00	KA1	KA3	KA3	KA5	KA3	
H124	28.50		KA5				
H125	42.80	KA5	KA5				
H126	28.50	KA42					
H127	28.50	KA43					
H128	57.00	KA41					
H129	28.50	KA2		KA2			
H130	42.80	KA2	KA3		KA2		
H131	42.80	KA2	KA3	KA3	KA2	KA2	
H132	57.00	KA2	KA2	KA3	KA3		
H133	28.50	KA3		KA2	KA2		
H134	57.00	KA3	KA3	KA2	KA2		
H135	57.00	KA3	KA2	KA2	KA2		
H136	28.50	KA3	KA3	KA5	KA5		
H137	228.00	KA45	KA45	KA44	KA44		
H138	42.80	KA3	KA3		KA2		
H139	28.50	KA5	KA5				
H140	57.00	KA44					
H141	57.00	KA43	KA43				
H142	114.00	KA1	KA1	KA41			
H143	57.00	KA3	KA1	KA5			
H144	57.00		K85			KA4	
H145	95.00	KA51					
H146	134.00	KA53	KA52				
H147	67.00	KA53					
H148	189.00	KA51	KA51				
H149	40.50	KA71					
H150	40.50		KA71				
H151	95.00	KA71	KA71				
H152	57.00	KA1	KA2	KA53	KA2		
H153	200.00	KA53	KA52				
H154	42.80	KA4	KA5				
H155	71.00	KA42	KA43	KA2			
H156	143.00	KA1	KA1	KA1	KA1	KA2	KA2
H157	71.00	KA1	KA2	KA1	KA3	KA2	
H158	71.00	KA1	KA1	KA1	KA3	KA2	
H159	86.00	KA1	KA1				
H161	67.00	KA52					
H162	28.50	KA2		KA5			
H163	57.00	K85		KA4			
H164	114.00	K85	K85	KA4	KA4		
H165	95.00	KA55					
H166	28.50	KA22		KA22			
H167	14.30	KA22		KA23			
H168	14.30						
H170	285.00	KA54	KA51		KA51		
H171	162.00	KA53	KA51				
H172	28.50	KA23	KA23				
H173	189.00	KA54	KA51				
H174	86.00	KA1	KA3	KA1	KA3		
H175	57.00	KA6	KA2	KA5	KA5		
H176	28.50	KA4					
H177	42.80	KA3	KA4				
H178	42.80	K85		KA3			
H179	161.00	KA53	KA55				

\*“H” Numbers not shown in their sequence are no longer used.



**Legend Plates**

Standard Markings	Plastic Legend Plates for use with Types K and SK Operators									Aluminum Legend Plates for use with Type K Operators		
	1.7" Square			2 1/4" Square			2 1/2" Square			Black Legend	Black Legend	Blue Legend
	Silver Legend with Black Letters	White Legend with Black Letters	Black Legend with White Letters	Silver Legend with Black Letters	White Legend with Black Letters	Black Legend with White Letters	Silver Legend with Black Letters	White Legend with Black Letters	Black Legend with White Letters			
	KN200	KN300	KN800	KN200	KN300	KN800	KN200	KN300	KN800	KN200	KN300	KN800

**For Push Button or Pilot Light**

Blank	KN200SP	KN200WP	KN200BP	KN100SP	KN100WP	KN100BP	KN700SP	KN700WP	KN700BP	KN200	KN300	KN800
Blank (red)	KN200RP	KN200RP	KN200RP	KN100RP	KN100RP	KN100RP	KN700RP	KN700RP	KN700RP	KN200R	KN300R	KN800R
Start	KN201SP	KN201WP	KN201BP	KN101SP	KN101WP	KN101BP	KN701SP	KN701WP	KN701BP	KN201	KN301	KN801
Stop	KN202SP	KN202RP	KN202RP	KN102RP	KN102RP	KN102RP	KN702RP	KN702RP	KN702RP	KN202	KN302	KN802
On	KN203SP	KN203WP	KN203BP	KN103SP	KN103WP	KN103BP	KN703SP	KN703WP	KN703BP	KN203	KN303	KN803
Off	KN204RP	KN204RP	KN204RP	KN104RP	KN104RP	KN104RP	KN704RP	KN704RP	KN704RP	KN204	KN304	KN804
Emerg. Stop	KN205RP	KN205RP	KN205RP	KN105RP	KN105RP	KN105RP	KN705RP	KN705RP	KN705RP	KN205	KN305	KN805
Forward	KN206SP	KN206WP	KN206BP	KN106SP	KN106WP	KN106BP	KN706SP	KN706WP	KN706BP	KN206	KN306	KN806
Reverse	KN207SP	KN207WP	KN207BP	KN107SP	KN107WP	KN107BP	KN707SP	KN707WP	KN707BP	KN207	KN307	KN807
Close	KN208SP	KN208WP	KN208BP	KN108SP	KN108WP	KN108BP	KN708SP	KN708WP	KN708BP	KN208	KN308	KN808
Open	KN209SP	KN209WP	KN209BP	KN109SP	KN109WP	KN109BP	KN709SP	KN709WP	KN709BP	KN209	KN309	KN809
Down	KN210SP	KN210WP	KN210BP	KN110SP	KN110WP	KN110BP	KN710SP	KN710WP	KN710BP	KN210	KN310	KN810
Up	KN211SP	KN211WP	KN211BP	KN111SP	KN111WP	KN111BP	KN711SP	KN711WP	KN711BP	KN211	KN311	KN811
Fast	KN212SP	KN212WP	KN212BP	KN112SP	KN112WP	KN112BP	KN712SP	KN712WP	KN712BP	KN212	KN312	KN812
Slow	KN213SP	KN213WP	KN213BP	KN113SP	KN113WP	KN113BP	KN713SP	KN713WP	KN713BP	KN213	KN313	KN813
High	KN214SP	KN214WP	KN214BP	KN114SP	KN114WP	KN114BP	KN714SP	KN714WP	KN714BP	KN214	KN314	KN814
Low	KN215SP	KN215WP	KN215BP	KN115SP	KN115WP	KN115BP	KN715SP	KN715WP	KN715BP	KN215	KN315	KN815
Inch	KN216SP	KN216WP	KN216BP	KN116SP	KN116WP	KN116BP	KN716SP	KN716WP	KN716BP	KN216	KN316	KN816
In Jog	KN217SP	KN217WP	KN217BP	KN117SP	KN117WP	KN117BP	KN717SP	KN717WP	KN717BP	KN217	KN317	KN817
Jog For.	KN218SP	KN218WP	KN218BP	KN118SP	KN118WP	KN118BP	KN718SP	KN718WP	KN718BP	KN218	KN318	KN818
Jog Rev.	KN219SP	KN219WP	KN219BP	KN119SP	KN119WP	KN119BP	KN719SP	KN719WP	KN719BP	KN219	KN319	KN819
Lower	KN220SP	KN220WP	KN220BP	KN120SP	KN120WP	KN120BP	KN720SP	KN720WP	KN720BP	KN220	KN320	KN820
Out	KN221SP	KN221WP	KN221BP	KN121SP	KN121WP	KN121BP	KN721SP	KN721WP	KN721BP	KN221	KN321	KN821
	KN222SP	KN222WP	KN222BP	KN122SP	KN122WP	KN122BP	KN722SP	KN722WP	KN722BP	KN222	KN322	KN822
Reset	KN223SP	KN223WP	KN223BP	KN123SP	KN123WP	KN123BP	KN723SP	KN723WP	KN723BP	KN223	KN323	KN823
Run	KN224SP	KN224WP	KN224BP	KN124SP	KN124WP	KN124BP	KN724SP	KN724WP	KN724BP	KN224	KN324	KN824
Start Jog	KN225SP	KN225WP	KN225BP	KN125SP	KN125WP	KN125BP	KN725SP	KN725WP	KN725BP	KN225	KN325	KN825
Test	KN226SP	KN226WP	KN226BP	KN126SP	KN126WP	KN126BP	KN726SP	KN726WP	KN726BP	KN226	KN326	KN826
Raise	KN227SP	KN227WP	KN227BP	KN127SP	KN127WP	KN127BP	KN727SP	KN727WP	KN727BP	KN227	KN327	KN827
Decrease	KN228SP	KN228WP	KN228BP	KN128SP	KN128WP	KN128BP	KN728SP	KN728WP	KN728BP	KN228	KN328	KN828
Increase	KN229SP	KN229WP	KN229BP	KN129SP	KN129WP	KN129BP	KN729SP	KN729WP	KN729BP	KN229	KN329	KN829
Left	KN230SP	KN230WP	KN230BP	KN130SP	KN130WP	KN130BP	KN730SP	KN730WP	KN730BP	KN230	KN330	KN830
Right	KN231SP	KN231WP	KN231BP	KN131SP	KN131WP	KN131BP	KN731SP	KN731WP	KN731BP	KN231	KN331	KN831
Cycle Start	KN232SP	KN232WP	KN232BP	KN132SP	KN132WP	KN132BP	KN732SP	KN732WP	KN732BP	KN232	KN332	KN832
Feed Start	KN233SP	KN233WP	KN233BP	KN133SP	KN133WP	KN133BP	KN733SP	KN733WP	KN733BP	KN233	KN333	KN833
Cycle Stop	KN234SP	KN234WP	KN234BP	KN134SP	KN134WP	KN134BP	KN734SP	KN734WP	KN734BP	KN234	KN334	KN834
Motor Run	KN236SP	KN236WP	KN236BP	KN136SP	KN136WP	KN136BP	KN736SP	KN736WP	KN736BP	KN236	KN336	KN836
Motor Stop	KN237SP	KN237WP	KN237BP	KN137SP	KN137WP	KN137BP	KN737SP	KN737WP	KN737BP	KN237	KN337	KN837
Power On	KN238SP	KN238WP	KN238BP	KN138SP	KN138WP	KN138BP	KN738SP	KN738WP	KN738BP	KN238	KN338	KN838
Pull To Start	N/A	N/A	N/A	KN179SP	KN179WP	KN179BP	KN779SP	KN779WP	KN779BP	N/A	KN379	N/A
Push To Stop	N/A	N/A	N/A	KN179SP	KN179WP	KN179BP	KN779SP	KN779WP	KN779BP	N/A	KN379	N/A

**For Selector Switch or Selector Push Button**

For.-Rev.	KN239SP	KN239WP	KN239BP	KN139SP	KN139WP	KN139BP	KN739SP	KN739WP	KN739BP	KN239	KN339	KN839
Hand-Auto.	KN240SP	KN240WP	KN240BP	KN140SP	KN140WP	KN140BP	KN740SP	KN740WP	KN740BP	KN240	KN340	KN840
High-Low	KN241SP	KN241WP	KN241BP	KN141SP	KN141WP	KN141BP	KN741SP	KN741WP	KN741BP	KN241	KN341	KN841
Jog-Run	KN242SP	KN242WP	KN242BP	KN142SP	KN142WP	KN142BP	KN742SP	KN742WP	KN742BP	KN242	KN342	KN842
Man.-Auto.	KN243SP	KN243WP	KN243BP	KN143SP	KN143WP	KN143BP	KN743SP	KN743WP	KN743BP	KN243	KN343	KN843
Off-On	KN244SP	KN244WP	KN244BP	KN144SP	KN144WP	KN144BP	KN744SP	KN744WP	KN744BP	KN244	KN344	KN844
On-Off	KN245SP	KN245WP	KN245BP	KN145SP	KN145WP	KN145BP	KN745SP	KN745WP	KN745BP	KN245	KN345	KN845
Open-Close	KN246SP	KN246WP	KN246BP	KN146SP	KN146WP	KN146BP	KN746SP	KN746WP	KN746BP	KN246	KN346	KN846
Raise-Lower	KN247SP	KN247WP	KN247BP	KN147SP	KN147WP	KN147BP	KN747SP	KN747WP	KN747BP	KN247	KN347	KN847
Run-Jog	KN248SP	KN248WP	KN248BP	KN148SP	KN148WP	KN148BP	KN748SP	KN748WP	KN748BP	KN248	KN348	KN848
Slow-Fast	KN250SP	KN250WP	KN250BP	KN150SP	KN150WP	KN150BP	KN750SP	KN750WP	KN750BP	KN250	KN350	KN850
Start-Stop	KN251SP	KN251WP	KN251BP	KN151SP	KN151WP	KN151BP	KN751SP	KN751WP	KN751BP	KN251	KN351	KN851
Up-Down	KN253SP	KN253WP	KN253BP	KN153SP	KN153WP	KN153BP	KN753SP	KN753WP	KN753BP	KN253	KN353	KN853
Low-High	KN254SP	KN254WP	KN254BP	KN154SP	KN154WP	KN154BP	KN754SP	KN754WP	KN754BP	KN254	KN354	KN854
Stop-Start	KN255SP	KN255WP	KN255BP	KN155SP	KN155WP	KN155BP	KN755SP	KN755WP	KN755BP	KN255	KN355	KN855
Left-Right	KN256SP	KN256WP	KN256BP	KN156SP	KN156WP	KN156BP	KN756SP	KN756WP	KN756BP	KN256	KN356	KN856
On-Auto	KN276SP	KN276WP	KN276BP	KN176SP	KN176WP	KN176BP	KN776SP	KN776WP	KN776BP	KN276	KN376	KN876
Auto-Off-Hand	KN258SP	KN258WP	KN258BP	KN158SP	KN158WP	KN158BP	KN758SP	KN758WP	KN758BP	KN258	KN358	KN858
For.-Off-Rev.	KN259SP	KN259WP	KN259BP	KN159SP	KN159WP	KN159BP	KN759SP	KN759WP	KN759BP	KN259	KN359	KN859
Hand-Off-Auto.	KN260SP	KN260WP	KN260BP	KN160SP	KN160WP	KN160BP	KN760SP	KN760WP	KN760BP	KN260	KN360	KN860
Man.-Off-Auto.	KN262SP	KN262WP	KN262BP	KN162SP	KN162WP	KN162BP	KN762SP	KN762WP	KN762BP	KN262	KN362	KN862
Open-Off-Close	KN263SP	KN263WP	KN263BP	KN163SP	KN163WP	KN163BP	KN763SP	KN763WP	KN763BP	KN263	KN363	KN863
Up-Off-Down	KN264SP	KN264WP	KN264BP	KN164SP	KN164WP	KN164BP	KN764SP	KN764WP	KN764BP	KN264	KN364	KN864
Low-Off-High	KN265SP	KN265WP	KN265BP	KN165SP	KN165WP	KN165BP	KN765SP	KN765WP	KN765BP	KN265	KN365	KN865
Jog-Stop-Run	KN267SP	KN267WP	KN267BP	KN167SP	KN167WP	KN167BP	KN767SP	KN767WP	KN767BP	KN267	KN367	KN867
High-Low-Off	KN270SP	KN270WP	KN270BP	KN170SP	KN170WP	KN170BP	KN770SP	KN770WP	KN770BP	KN270	KN370	KN870
High-Off-Low	KN277SP	KN277WP	KN277BP	KN177SP	KN177WP	KN177BP	KN777SP	KN777WP	KN777BP	KN277	KN377	KN877
Auto-Man.-Off	KN278SP	KN278WP	KN278BP	KN178SP	KN178WP	KN178BP	KN778SP	KN778WP	KN778BP	KN278	KN378	KN878

- ▲ Legend plate has red background with silver letters.
- Legend plate has red background with black letters.

For Pricing Information..... page 17-82

For additional information, reference Catalog #9001CT0001.

17 PUSH BUTTONS AND OPERATOR INTERFACE

# Push Buttons—Class 9001 Type K and SK— 30 mm

## Accessories



www.SquareD.com

For the most up-to-date information

17 PUSH BUTTONS AND OPERATOR INTERFACE

### Legend Plates—Special Marking

Legend Plate	Description	Type	Price	
KN100*P (Plastic) ▲ 2 1/4" Square	Standard Markings	Select from Table on Pg. 17-81	\$2.90	
	Special Marking (Specify Marking Required)	Silver Field, Black Letters	KN199SP	12.30
		White Field, Black Letters	KN199WP	
		Red Field, Black Letters	KN199RP	
KN200 Aluminum	Standard Markings	Select from Table on Pg. 17-81	2.90	
	Special Marking (Specify Marking Required)	Black Field	KN299	12.30
Red Field		KN299R		
KN200*P (Plastic) ▲ 1.7" Square	Standard Markings	Select from Table on Pg. 17-81	2.90	
	Special Marking (Specify Marking Required)	Silver Field, Black Letters	KN299SP	12.30
		White Field, Black Letters	KN299WP	
		Red Field, Black Letters	KN299RP	
KN300 Aluminum	Standard Markings	Select from Table on Pg. 17-81	2.90	
	Special Marking (Specify Marking Required)	Black Field	KN399	12.30
Red Field		KN399R		
KN400 Aluminum	Blank	KN400	6.60	
	Any Marking (Specify Marking)	KN499	15.20	
KN500 Aluminum	Standard Markings	Select from Table Below	2.90	
	Special Marking (Specify Marking Required)	Black Field	KN599	12.30
Green Red Field		KN519		
KN600 Aluminum	Blank	Black Field Red Field	KN600 KN600R	6.60
	Any Marking (Specify Marking)	Black Field Red Field	KN699 KN699R	15.20
KN700*P (Plastic) ▲ 2 1/2" Square	Standard Markings	Select from Table on page 17-81	2.90	
	Special Marking (Specify Marking Required)	Silver Field, Black Letters	KN799SP	12.30
		White Field, Black Letters	KN799WP	
		Red Field, Black Letters	KN799RP	
KN800 Aluminum	Standard Markings	Select from Table on page 17-81	2.90	
	Special Marking (Specify Marking Required)	Blue Field	KN899	12.30
Red Field		KN899R		
KN900 Aluminum	Blank	KN900	2.90	
	Any Marking (Specify Marking)	KN999	12.30	

▲ Other colors available (see table below):

	Plate Color	Letter Color	1.7 Inch Square	2.25 Inch Square	2.5 Inch Square	Price
Blank Legend Plates	Yellow	Black	KN200YP	KN100YP	KN700YP	\$2.90
	Green	White	KN200GP	KN100GP	KN700GP	
	Blue	White	KN200LP	KN100LP	KN700LP	
	Red	White	KN200CP	KN100CP	KN700CP	
	Orange	White	KN200AP	KN100AP	KN700AP	
	Burnt Orange	Black	KN200HP	KN100HP	KN700HP	
Special Engraved Legend Plates	Yellow	Black	KN299YP	KN199YP	KN799YP	12.30
	Green	White	KN299GP	KN199GP	KN799GP	
	Blue	White	KN299LP	KN199LP	KN799LP	
	Red	White	KN299CP	KN199CP	KN799CP	
	Orange	White	KN299AP	KN199AP	KN799AP	
	Burnt Orange	Black	KN299HP	KN199HP	KN799HP	

### Maximum Number of Lines and Characters for Type KN Legend Plates

Type	KN100	KN200	KN300	KN400	KN500	KN600	KN700	KN800	KN900
Max. No. of Char. per Line	16	14	18	18	8 per field	22	17	18	18 per pos.
Max. No. of Lines	2	1	3	2	2 per field	4	2	2	1 per pos.

The maximum number of characters and lines given above is a practical maximum and is based on a minimum size of characters to facilitate easy reading.

### Circular Legends for Emergency Stop Mushroom Heads (yellow background)

Diameter	Text	Catalog Number	Price
60 mm	Blank	9001KN9100	\$2.90
	EMERGENCY STOP	9001KN9330	
90 mm	Blank	9001KN8100	
	EMERGENCY STOP	9001KN8330	

### Mounting Hole For All Types K, SK, and KX Control Unit

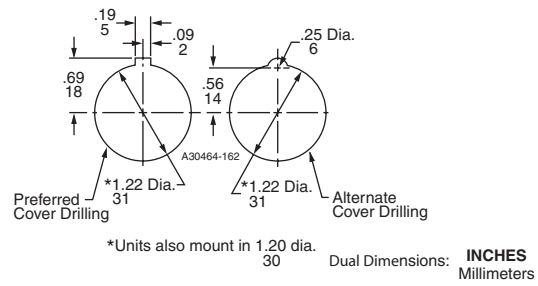

Use Greenlee Tool #60242 for punching mounting hole and notch.

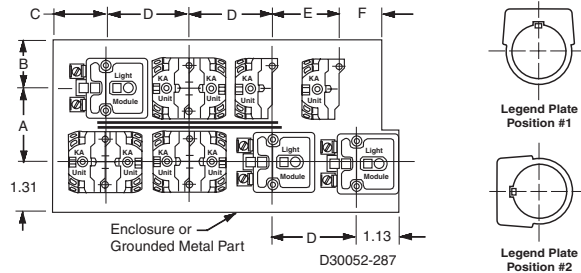

### Minimum Centerline Spacing for Type K & SK Control Units

Legend Plate	Operator	Centerline Spacing (Inches)					
		A	B	C	D	E	F
<b>Legend Plate Orientation Position #1</b>							
KN2 KN5	Standard Push Button	1.75	1.31	1.44	2.25	1.69	0.88
	1 3/8" Dia. Mushroom	1.75	1.31	1.44	2.25	1.69	0.88
	2 1/4" Dia. Mushroom	2.25	1.31	1.44	2.25	2.25	1.12
KN3	Selector Switch Knobs	1.75	1.31	1.44	2.25	1.69	0.88
	Standard Push Button	2.00	1.31	1.44	2.25	1.75	0.88
	1 3/8" Dia. Mushroom	2.00	1.31	1.44	2.25	1.75	0.88
KN4	2 1/4" Dia. Mushroom	2.25	1.31	1.44	2.25	2.25	1.12
	Selector Switch Knobs	2.00	1.31	1.44	2.25	1.75	0.88
	Standard Push Button	1.94	1.31	1.44	2.25	1.62	0.88
KN6	1 3/8" Dia. Mushroom	1.94	1.31	1.44	2.25	1.62	0.88
	2 1/4" Dia. Mushroom	2.25	1.31	1.44	2.25	2.25	1.12
	Selector Switch Knobs	1.74	1.31	1.44	2.25	1.62	0.88

### Legend Plate Orientation Position #2









KN2 KN5	Standard Push Button	1.62	1.31	1.44	2.25	1.75	0.88
	1 3/8" Dia. Mushroom	1.62	1.31	1.44	2.25	1.75	0.88
	2 1/4" Dia. Mushroom	2.25	1.31	1.44	2.25	2.25	1.12
KN3	Selector Switch Knobs	1.62	1.31	1.44	2.25	1.75	0.88
	Standard Push Button	1.75	1.31	1.44	2.25	2.00	0.88
	1 3/8" Dia. Mushroom	1.75	1.31	1.44	2.25	2.00	0.88
KN4	2 1/4" Dia. Mushroom	2.25	1.31	1.44	2.25	2.25	1.12
	Selector Switch Knobs	1.75	1.31	1.44	2.25	2.00	0.88
	Standard Push Button	1.62	1.31	1.44	2.25	1.94	1.00
KN6	1 3/8" Dia. Mushroom	1.62	1.31	1.44	2.25	1.94	1.00
	2 1/4" Dia. Mushroom	2.25	1.31	1.44	2.25	2.25	1.12
	Selector Switch Knobs	1.62	1.31	1.44	2.25	1.94	1.00

### Special Legend Plates





Type	Type KN500 (For Use with Dual Function Operators KR6, KR7 and KR67)	
	Green	Red
KN500 KN501 KN502	Blank Start On	Blank Stop Off
KN520 KN521 KN522 KN523 KN524 KN525 KN526	Blank Start On Forward Up High Open	Blank Stop Off Reverse Down Low Close

For additional information, reference Catalog Number 9001CT0001.

**Padlock Attachments**

	Used On	Description	Type	Price
	<b>Type K</b> non-illuminated push button — Standard or mushroom (KR4, KR5 mushroom buttons only).	Holds button in depressed position and can be padlocked.	K4	<b>\$28.50</b>
	<b>Types K and SK</b> non-illuminated push buttons with or without protective boots.	Holds button in depressed position when padlocked.	K5	<b>47.60</b>
			K97	<b>28.50</b>
	<b>Types K and SK</b> non-illuminated push buttons, cover type attachment. KR, SKR	Attachment can be padlocked. Does not hold button in depressed position.	K6	<b>28.50</b>
	<b>Types K and SK</b> push buttons, cover type attachment.	Spring loaded cover cannot be padlocked. Does not hold button in depressed position.	K60	<b>38.00</b>
	<b>Types K and SK</b> push-pull operator and illuminated push buttons. KR8, KR9	Holds button in depressed position and can be padlocked.	K62	<b>47.60</b>
	<b>KR11U and KR12U</b> Interlocked Assembly	Holds maintained button in depressed position and can be padlocked.	K96	<b>28.50</b>
	<b>Type KR9 &amp; SKR9</b> Push-Pull operators—Non-Illuminated and Illuminated	Holds button in depressed position. Can be padlocked.	K162	<b>39.00</b>

**Padlock Attachments**

	Used On	Description	Type	Price
	<b>Types K and SK</b> selector switches and potentiometers (will not work with gloved-hand knob).	Cover type attachment that can be padlocked to keep unauthorized personnel from tampering with the operator.	K7	<b>\$28.50</b>
	<b>Types K and SK</b> selector switches and potentiometers (will not work with gloved-hand knob).	Same as 9001K7 but with spring loaded lockout cover.	K107	<b>37.50</b>
	<b>Types K and SK</b> illuminated push buttons (with or without guard) and key operated push buttons.	Cover type attachment that can be padlocked to keep unauthorized personnel from tampering with the operator.	K108	<b>28.50</b>
	<b>Types K and SK</b> illuminated push buttons (with or without guard) and key operated push buttons.	Same as 9001K108 but with spring loaded lockout cover.	K109	<b>38.00</b>
	<b>Types K and SK</b> maintained push-pull operators using 1 3/8" dia. mushroom buttons (-20 series as shown on page 17-84).	Cover type attachment that holds mushroom button in depressed position and can be padlocked.	K110	<b>36.00</b>

**Protective Boots**





These Type KU protective boots are recommended for very dirty environments or severe hose down, but they are not required for UL Type 4 rating on the Type K operators or UL Type 4 or 4X rating on the Type SK operators. The K1 wrench (see page 17-86) is required for installation of these boots.

For Non-Illuminated Push Buttons ▲			Clear Color for	Type	Price
<b>Color</b>	<b>Type</b>	<b>Price</b>	Standard knob selector switch	KU17	<b>\$28.50</b>
Black	KU1	<b>\$19.10</b>	Gloved-hand cap for use on standard knob selector switch	KU18	<b>28.50</b>
Red	KU2	<b>19.10</b>	Standard pilot light and maintained contact push buttons	KU27	<b>28.50</b>
Blue	KU3	<b>19.10</b>			
Brown	KU4	<b>19.10</b>	Push-to-test and illuminated push button without guard	KU37	<b>28.50</b>
Green	KU5	<b>19.10</b>			
Yellow	KU6	<b>19.10</b>	Illuminated push button with guard	KU47	<b>38.00</b>
Clear	KU7	<b>19.10</b>			
Clear	KU8	<b>28.50</b>	(Provides Full Guard)		

▲ Use KU27 for maintained contact push buttons.

**Mushroom Button Guards**

	Aluminum Mushroom Guard for 1 3/8" Mushroom Button Operator (KR4, KR24)		Yellow Plastic Extended Mushroom Guard for 1 3/8" and 1 5/8" Mushroom Button Operators		Aluminum Mushroom Guard for 2 1/4" Mushroom Button Operator		
<b>Type</b>	<b>Price</b>	<b>Type</b>	<b>Used On</b>	<b>Price</b>	<b>Type</b>	<b>Used On</b>	<b>Price</b>
K48	<b>\$38.</b>	K56 ◆	KR4 SKR4	<b>\$38.</b>	K68	KR5	<b>\$38.</b>
		K56 ★■	KR8, KR9, SKR8, SKR9	<b>45.</b>	K685	KR25	<b>45.</b>

■ The mushroom guard has finger holes for push-pull operators.  
◆ B=Black G=Green R=Red Y=Yellow  
★ R=Red Y=Yellow

**Closing Plates**

	Round (1 1/2" Dia.)	
<b>Description</b>	<b>Type</b>	<b>Price</b>
Gray	K51 ▼	<b>\$9.50</b>
Chrome Plated	K52 ▼	<b>9.50</b>

▼ Meets UL and NEMA 1, 2, 3, 4, 4X, 6, 12 and 13.

Dimensions . . . . . Catalog 9001CT0001

For additional information, reference Catalog #9001CT0001.

# Push Buttons—Class 9001 Type K and SK



















## Accessories



www.SquareD.com

For the most up-to-date information

17 PUSH BUTTONS AND OPERATOR INTERFACE

Description	Color	Type	Package Qty.	Price Each	Description	Color	Type	Package Qty.	Price Each
 Color inserts for KR1, KR2, KR3, SKR1, SKR2, SKR3, KR11, KR12, SKR11, SKR12, KR12, T, TRD	Black Blue Gray Green Orange Red Universal ▲ White Yellow	T8BK T8BE T8GY T8GN T8OE T8RD T8U T8WH T8YW	10 10 10 10 10 10 7 10 10	\$0.48 0.48 0.48 0.48 0.48 0.48 3.80 0.48 0.48	 1 3/8" Mushroom Knob for Illuminated Push Buttons K2L, SK2L ☆	Amber Blue Clear Green Red White Yellow	A20 L20 C20 G20 R20 W20 Y20	1 1 1 1 1 1 1	6.60
 1 3/8" Snap-in Mushroom knob for KR4 and SKR4 ◆	Black Blue Green Orange Red Red ■ Yellow	K16B K16L K16G K16S K16R K16R05 K16Y	1 1 1 1 1 1 1	28.50 28.50 28.50 28.50 28.50 31.70 28.50	 2 1/4" Mushroom Knob for Illuminated Push Buttons K2L, SK2L ☆	Amber Blue Clear Green Red White Yellow	A21 L21 C21 G21 R21 W21 Y21	1 1 1 1 1 1 1	6.60
 2 1/4" Snap-in Mushroom knob for KR5 and SKR5 ★	Black Blue Green Orange Red Red ■ Yellow	K17B K17L K17G K17S K17R K17R05 K17Y	1 1 1 1 1 1 1	28.50 28.50 28.50 28.50 28.50 31.70 28.50	 Plastic Fresnel Pilot Light Lens for KP, KT, SKP, SKT	Amber Blue Clear Green Red White Yellow	A31 L31 C31 G31 R31 W31 Y31	1 1 1 1 1 1 1	6.60
 1 3/8" Screw-on Mushroom knob for KR24 and SKR24 ▼	Black Blue Green Orange Red Yellow	K92B K92L K92G K92S K92R K92Y	1 1 1 1 1 1	28.50	 Domed Plastic Pilot Light Lens for KP, KT, SKP, SKT	Amber Blue Clear Green Red White Yellow	A9 L9 C9 G9 R9 W9 Y9	1 1 1 1 1 1 1	6.60
 2 1/4" Screw-on Mushroom knob for KR25 and SKR25 △	Black Blue Green Orange Red Yellow	K93B K93L K93G K93S K93R K93Y	1 1 1 1 1 1	28.50	 Glass Pilot Light Lens for KP, KT	Amber Blue Clear Green Red White Yellow	A6 L6 C6 G6 R6 W6 Y6	1 1 1 1 1 1 1	6.60
 Push-Pull Knobs for KR8, KR9, SKR8, SKR9 Operators	Amber Black □ Blue Clear Green Orange □ Red Red ▽ White Yellow	A22 B23 L22 C22 G22 S23 R22 R2205 W22 Y22	1 1 1 1 1 1 1 1 1 1	6.60 6.60 6.60 6.60 6.60 6.60 10.50 6.60 6.60	 Standard Selector Switch Knob for K and SK Selector Switches	Amber Black □ Blue Clear Green Orange □ Red White Yellow	A8 B11 L8 C8 G8 S11 R8 W8 Y8	1 1 1 1 1 1 1 1 1	6.60
 Color Inserts for Dual Function Operators KR6, KR7, KR67	Black Green Red Universal ◇	B19 G19 R19 U19	10 10 10 10	0.95 0.95 0.95 5.70	 Gloved-Hand Selector Switch Knob for K and SK Selector Switches	Amber Black □ Blue Clear Green Orange □ Red White Yellow	A24 B25 L24 C24 G24 S25 R24 W24 Y24	1 1 1 1 1 1 1 1 1	6.60
 Caps for Illuminated Push Buttons K1L, K2L, K3L, SK1L, SK2L	Amber Blue Clear Green Red White Yellow	A7 L7 C7 G7 R7 W7 Y7	1 1 1 1 1 1 1	6.60	 Coin Operated Selector Switch Knob for K and SK Selector Switches	Black □ Blue Clear Green Red Yellow	B18 L16 C16 G16 R16 Y16	1 1 1 1 1 1	6.60
 Color Inserts for KQ and TQ Selector Push Buttons	Black Blue Green Orange Red White Yellow	T5BK T5BE T5GN T5OE T5RD T5WH T5YW	10 10 10 10 10 10 10	0.95	 Selector Switch Cams		<b>Cam</b> B C D E F G H J L M	<b>Type</b> K13B K13C K13D K13E K13F K13G K13H K13J K13L 3105402402	<b>Price</b> \$4.20 each

- ▲ Includes one each of the following color inserts: Black, Red, Green, Yellow, Orange, Blue, and White.
- "EMERGENCY STOP" is in raised letters and hot stamped white across the front of the mushroom button.
- ◆ The mushroom button cap listed here may be assembled to a 9001KR1U or SKR1U to form a 9001KR4 or SKR4.
- ★ The mushroom button cap listed here may be assembled to a 9001KR1U or SKR1U to form a 9001KR5 or SKR5.
- ▼ The mushroom button cap listed here may be assembled to a 9001KR20 to form a 9001KR24 or SKR24 to form a 9001SKR24.
- △ The mushroom button cap listed here may be assembled to a 9001KR20 to form a 9001KR25 or a SKR20 to form a 9001SKR25.
- These color caps are opaque and are for use on non-illuminated operators only.
- ◇ Includes two of each of the following color inserts: Black, Red, and Green.
- ☆ May be used on KR8 and KR9 operators. Order mushroom button and K54 adapter (no charge) from page 17-85. Using the K54 adapter voids Type 6 rating.
- ▽ Red knob with "Push Emergency Stop" marked on top of knob.

For additional information, reference Catalog #9001CT0001.

**Basic Operators**

(Does not include Color Caps, Mushroom Buttons, Knobs, Selector Switch Cams, Contact Blocks, Light Modules or Legend Plates)

Description	For UL Types/NEMA		Price
	1, 3R, 4, 12, 13	4, 4X, 13	
Non-Illuminated Push Button (Extended Guard)	KR2	SKR2	\$25.70
Non-Illuminated Push Button (No Guard)	KR3	SKR3	25.70
Non-Illuminated Push Button (Mushroom Button/Screw-On)	KR20	SKR20	25.70
Non-Illuminated Dual Push Button (Momentary)	KR6	...	52.00
Non-Illuminated Dual Push Button (Momentary Interlocked)	KR67	...	81.00
Non-Illuminated Dual Push Button (Maintained Interlocked)	KR7	...	81.00
Momentary Pull—Maintained Neutral—Momentary Push	KR8 ▲★	SKR8 ▲	50.00
Maintained Pull—Maintained Push	KR9 ▲★	SKR9 ▲	80.00
Illuminated Push Button (Full Guard—Plastic Top)	K1L ■	SK1L ■	28.50
Illuminated Push Button and Push-To-Test (No Guard)	K2L ■◆	SK2L ■◆	19.20
Illuminated Push Button (Full Guard—Metal Top)	K3L ■	...	28.50
Standard Pilot Light	KP	SKP	19.20
3 Position Maintained Selector Switch	KS4 ▲	SKS4 ▲	24.20
3 Position Spring Return Both Sides To Center—Selector Switch	KS5 ▲	SKS5 ▲	43.20
3 Position Spring Return Left To Center—Selector Switch	KS6 ▲	SKS6 ▲	43.20
3 Position Spring Return Right To Center—Selector Switch	KS7 ▲	SKS7 ▲	43.20

- ▲ Operator can be converted to an illuminated operator by removing the liner (9001K2A) and adding a light module.
- Operator can be converted to a non-illuminated operator by adding liner (9001K2A).
- ◆ Operator includes jumper wires for push-to-test conversion.
- ★ These operators can be supplied with 1<sup>3</sup>/<sub>8</sub>" or 2<sup>1</sup>/<sub>4</sub>" dia. mushroom buttons. For 1<sup>3</sup>/<sub>8</sub>" add \*20 to type number. The ★ refers to the color chosen—see page 17-84. For 2<sup>1</sup>/<sub>4</sub>" Add \*21 to type number. The ★ refers to the color chosen—see page 17-84. Voids UL and NEMA 6 Rating.

**Selector Switch Angular Travel (Types K, SK and KX)**

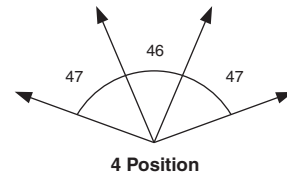
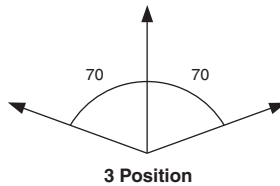
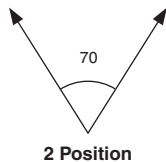

**Maximum Contact Block Usage**

(Includes Types K, SK and KX)

**2 blocks mounted side by side only:** Any 2, 3 or 4 position spring return selector switch (non-illuminated, illuminated or keyed).

**2 blocks mounted in tandem on one side only:** Any 2 operator interlocked push button.

**2 blocks mounted in tandem (total of four blocks):** Any selector push button, keyed push button, 2, 3, or 4 position maintained selector switch (non-illuminated, illuminated or keyed), push-pull operators (non-illuminated or illuminated), joy stick, dual push button.

**3 blocks mounted in tandem (total of six blocks):** Single momentary push buttons (non-illuminated or illuminated).

**Operator Service Temperature Range:**

-22° to +140° Fahrenheit at 50% relative humidity  
-30° to +60° Celsius

**Environmental Ratings:**

Types K and KX: The Type K (Series H) and KX operators are UL approved for use in Types 1, 2, 3, 3R, 4, 6, 12 and 13 flat surface enclosures.

Type SK: The Type SK operators are UL approved for use in Types 1, 2, 3, 3R, 4, 4X, 6, 12 and 13 flat surface enclosures.

Types K, SK and KX: For hazardous location use—see page 17-79.

**Dimensions:**

Types K, SK and KX: See Catalog 9001CT0001.

**Mounting Hole Dimensions:**

See Catalog 9001CT0001.

**Minimum Centerline Spacing:**

Types K, SK and KX: See Catalog 9001CT0001.

**Non Hazardous Locations**

Types K, SK and KX		File CCN #42259 NKCR		File Class LR25490 3211 03
--------------------	--	----------------------	--	----------------------------

**Hazardous Locations (see page 17-79)**

Types K, SK		File CCN E10054(N) NOIV		File Class LR26817 3218 02
-------------	--	-------------------------	--	----------------------------

For additional information, reference Catalog #9001CT0001.

# Push Buttons—Class 9001 Type K and SK—30 mm

## Replacement Parts

**SQUARE D**  
www.SquareD.com  
For the most up-to-date information

17 PUSH BUTTONS AND OPERATOR INTERFACE

### Ring Nuts

Used On	Type	Used On	Type	Price
K1L	K44	SK1L	SK44	\$12.30
K30-K37	K45	...	...	2.90
K70-K73	K45	...	...	2.90
K20, K21, K22, K23	K45	SK20, SK21, SK22, SK23	SK45	2.90
K20, K21, K22, K23 ♦	SK46	SK20, SK21, SK22, SK23 ♦	SK46	2.90
K2L	K49	SK2L	SK49	2.90
K3L	K111	...	...	12.30
KP, KTR	K41	SKP, SKTR	SK41	2.90
KR1	K41	SKR1	SK41	2.90
KR11	K42	SKR11	SK42	2.90
KR12 ▲	K42	SKR12 ▲	SK42	2.90
KR12 ■	K41	SKR12 ■	SK41	2.90
KR13, 14, 15	K55	...	...	2.90
KR2	K42	SKR2	SK42	2.90
KR20	K49	...	...	2.90
KR24	K49	...	...	2.90
KR25	K49	...	...	2.90
KR3	K40	SKR3	SK40	2.90
KR4	K41	SKR4	SK41	2.90
KR5	K41	SKR5	SK41	2.90
KR6	K47	...	...	2.90
KR67	K47	...	...	2.90
KR7	K47	...	...	2.90
KR8	K58	SKR8	6509704401	2.90
KR9	K41	SKR9	SK41	2.90
KS	K45	SKS	SK45	2.90
KS ♦	SK46	SKS ♦, SKRU11	SK46, SK41	2.90, 2.90
KT	K49	SKT	SK49	2.90

- ▲ Maintained button of two button operator.
- Momentary button of two button operator.
- ♦ Secondary ring nut (holds knob on selector switch or potentiometer).

### Replacement Lamps For Series A-F (black) Light Modules

Light Module Type	Lamp Number (ANSI)	Square D Replacement Lamps	
		Part Number	Price
KM1	GE44★	...	...
KM2	GE1490	2550101003	\$ 8.30
KM3	GE44★	...	...
KM4	GE1490	2550101003	8.30
KM5	GE44★	...	...
KM6	GE44★	...	...
KM7	GE44★	...	...
KM8	GE44★	...	...
KM9	GE755	2550101020	8.30
KM11	CMDK1A5	2550105014	11.00
KM12	CMDK1A5	2550105014	11.00
KM13	CMDK1A5	2550105014	11.00
KM14	CMDK1A5	2550105014	11.00
KM15	CMDK1A5	2550105014	11.00
KM21	SYL12PSB	2550105003	11.00
KM22	SYL12PSB	2550105003	11.00
KM23	SYL28PSB	2550105008	11.00
KM25	SYL120PSB	2550105005	11.00
KM31	SYL6PSB	2550105007	11.00
KM32	SYL12PSB	2550105003	11.00
KM34	SYL24PSB	2550105004	11.00
KM35	SYL28PSB	2550105008	11.00
KM36	SYL48PSB	2550105009	11.00
KM37	SYL60PSB	2550105010	11.00
KM38	SYL120PSB	2550105005	11.00

★ GE44 and GE755 are interchangeable (GE755 gives longer life). If a GE44 lamp is ordered, a GE755 (2550101020) will be substituted. For a replacement lamp in a current series light module see the light module listing on page 17-77.

### Repair Parts

Description	Part Number	Price
E10 Key	2941101100	\$6.60
Gray cap for KR11, KR12, SKR11, or SKR12	3105217001	6.60
Clear plastic top (only) for 9001K44 & SK44	4487D63XI	5.30
Ring Nut		
Gasket for Type K and SK Push-Pull Knob	6509701801	1.30
Gasket for Plastic Illuminated Lens	6509701901	1.30
Gasket for Type K and SK selector switch knob	3105406401	1.30
Black Compensating Gasket (Type K and SK Operators)	6509702001	1.30
Liner for Non-Illuminated Operators	6509704901	N/C
Locking Thrust Washer	6512231201	1.30
Nylon Spacer	6509705001	1.30
Locking Thrust Washer (Std. Type SK Operator)	6512240601	1.30
Push-Pull Mushroom Adapter ▼	K54	N/C
Rubber Boot for Joystick	6512243201	4.80
Knob on Joysticks without latch	4458D20X3	6.30

▼ Allows Type -20 and -21 mushroom color caps to be used on push-pull operators. Use of 9001K54 voids Type 6 rating.

### KU Replacement Ring Nuts (Threaded Inside and Out)

Used On	Part Number	Price
KU1 through KU8, KU27, KU37, KU47	3105204101	\$2.90
KU17, KU18	3105205901	7.10

### Interlock



For mechanically interlocking two push buttons so that only one button can be depressed at a time. A Type K3 attachment is furnished with the 9001 KR11, KR12, SKR11, SKR12, SKRU1 and SKRU11 operators. However, these are maintained operators and the K3 interlock serves to release one of the buttons when the other is depressed. When used with momentary contact buttons, the K3 interlock does not hold the buttons in the depressed position. It simply prevents pushing both buttons at the same time. The Type K3 interlock is mounted behind the operators. Operators not included.

Type	Price
K3	\$19.10

### Screwdriver



Used to tighten mounting screws on contact blocks and light modules.

Type	Price
K69	\$23.70

### Wrenches



K95



K1









Where Used	Type	Price
For tightening ring nuts on Types K, KX, SK and J control units	K95	\$28.50
For protective cap kits	K1	47.60

For additional information, reference Catalog #9001CT0001.









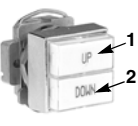

The operators listed below come complete with color caps, legend inserts/plates, contact blocks, and light modules (illuminated operators only) and can be ordered using the short type number. If the operator you desire is not listed below, see pages 17-88 through 17-92. For a component breakdown of each of the operators listed on this page, refer to Product Data Bulletin M-603. UL Types 4, 4X, 13/NEMA 4, 4X, 13.

For use in hazardous locations—See page 17-79.







**Single Illuminated and Non-Illuminated Push Buttons**

Description	Button Color	Legend Marking	Contacts	Type	Price
	Green	Start		KXRA101	\$57.00
	Red	Stop		KXRA102	
	Green	Start		KXRA133	
	Red	Stop		KXRA134	
	Red Mushroom	Emerg. Stop		KXRN105	
Illuminated 110-120 V, 50-60 Hz Transformer	Green	Start		KXRB103	134.00
	Red	Emerg. Stop		KXRB104	
	Red Mushroom	Emerg. Stop		KXRP106	162.00

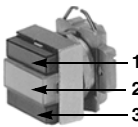



**Dual Push Buttons**

Description	Top Button (#1)	Bottom Button (#2)	Contacts	Type	Price
	Start (Green-Mom.)	Stop (Red-Mom.)		KXRC111	\$114.
	Start (Green-Mom.)	Stop (Red-Mom.)		KXRC136	86.
	Up (Green-Mom.)▲	Down (Green-Mom.)▲		KXRD112	119.
	Open (Green-Mom.)▲	Close (Green-Mom.)▲		KXRD113	119.
	Forward (Green-Mom.)▲	Reverse (Green-Mom.)▲		KXRD114	119.
	Up (Green-Mom.)▲	Down (Green-Mom.)▲		KXRD140	90.
	Open (Green-Mom.)▲	Close (Green-Mom.)▲		KXRD141	90.
	Forward (Green-Mom.)▲	Reverse (Green-Mom.)▲		KXRD142	90.
	Start (Green-Maint.)▲	Stop (Red-Maint.)▲		KXRE115	114.
	Reset (Green-Mom.)▲	Stop (Red-Maint.)▲		KXRF116	114.

**Dual Push Button With One Pilot Light**

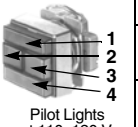







Description	Top Button (#1)	Middle Lens (#2)	Bottom Button (#3)	Contacts	Type	Price
	Start (Green-Mom.)	On (Red)	Stop (Red-Mom.)		KXRG117	\$209.
	Start (Green-Mom.)	On (Red)	Stop (Red-Mom.)		KXRG137	180.
	Blank (Green-Mom.)▲	Blank (Red)	Blank (Green-Mom.)▲		KXRH118	219.
	Start (Green-Maint.)▲	On (Red)	Stop (Red-Maint.)▲		KXRJ119	219.
	Reset (Green-Mom.)▲	On (Red)	Stop (Red-Maint.)▲		KXRK120	171.

**Dual Push Button With Dual Pilot Lights**

Description	Top Button (#1)	Left Lens (#2)	Right Lens (#3)	Bottom Button (#4)	Contacts	Type Number	Price
	Start (Green-Mom.)▲	On (Red)	Off (Green)	Stop (Red-Mom.)		KXRL121	\$323.
	Number 1 (White-Mom.)	1 White	2 Blue	Number 2 (Blue-Mom.)		KXRL132	333.
	Start (Green-Mom.)▲	On (Red)	Off (Green)	Stop (Red-Mom.)		KXRL138	294.
	Blank (Green-Mom.)▲	Blank (Red)	Blank (Red)	Blank (Green-Mom.)▲		KXRM122	351.

▲ Buttons are mechanically interlocked.

**Selector Switches**

Non-Illuminated						
Description	Positions	Legend	Knob	Contacts	Type	Price
	2-Maint.	Off-On	Black		KXSA125	\$66.
	2-Maint.	Off-On	Black		KXSA139	52.
	3-Maint.	Hand-Off-Auto.	Black		KXSD126	66.
	3-Maint.	Hand-Off-Auto.	Black		KXSD127	95.
Illuminated—110-120 V, 50-60 Hz, Transformer						
Description	Positions	Legend	Knob	Contacts	Type	Price
	2-Maint.	Off-On	Red		KXSJ128	\$143.
	3-Maint.	Hand-Off-Auto.	Red		KXSM129	143.
	3-Maint.	Hand-Off-Auto.	Red		KXSM130	171.

**Single Pilot Light**

Description	Lens Color	Legend Marking	Type	Price	
110-120 V, 50-60 Hz Transformer 	Standard	Red Green	On Off	KXPA107 KXPA108	\$105.
	Push-To-Test	Red Green	On Off	KXTA109 KXTA110	134. 134.

**Dual Push-To-Test Pilot Light**

(Pushing Button #1 Tests Pilot Light #2—Pushing Button #4 Tests Pilot Light #3)

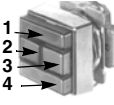
Description	Top Button (#1)	Left Lens (#2)	Right Lens (#3)	Bottom Button (#4)	Type	Price
	Green	Blank	Red	Blank	KXTC123	\$312.
	Blank	Red	Blank	Green		

**Dual Pilot Light**

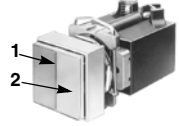
Description	Left Lens (#1)	Right Lens (#2)	Type	Price
	Red	Green	KXPB124	\$191.
	On	Off		

**Four-Field Pilot Light**

Description	Top Left (#1)	Top Right (#2)	Bottom Left (#3)	Bottom Right (#4)	Type Number	Price
	White	Blue	Green	Red	KXPC131	\$362.
	Blank	Blank	Blank	Blank		
110-120 V, 50-60 Hz Transformer						
Remote Test ■ 120 Vac Resistor	White	Blue	Green	Red	KXTE150 ■	399.

■ If all four lamps are illuminated at the same time continuously—do NOT operate above 120 Vac.

For additional information, reference Catalog #9001CT0001.

# Push Buttons—Class 9001 Type KX—30 mm

## Square Multifunction Operators



**Single Button Momentary**  
9001KXRA, KXRB

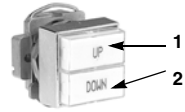

**Dual Push Button (Non-Illuminated Only)**  
9001KXRC, KXRD, KXRE, KXRF

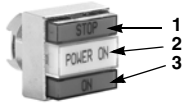

**Two Push Buttons (1 & 3)**  
**One Pilot Light (2)**  
9001KXRG, KXRH, KXRJ, KXRK

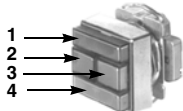

**Two Push Buttons (1 & 4)**  
**Two Pilot Lights (2 & 3)**  
9001KXRL, KXRM

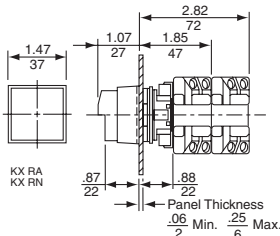

**Single Push Button Operator Non-Illuminated**

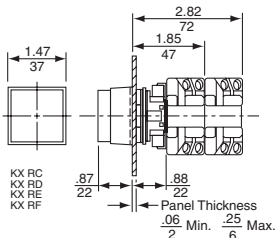

**Dual Push Button Operator Non-Illuminated**

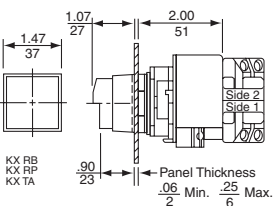

**Single Push Button Operator Illuminated**

**Dual Push Button Operator Illuminated**

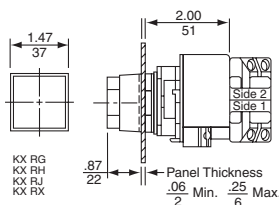

**Dual Lamp Push Button Operator**

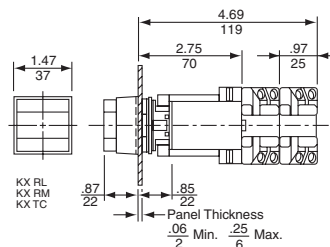

### Push Button and Pilot Light Combinations—UL Types 4, 4X, 13/NEMA 4, 4X, 13

For use in hazardous locations—See page 17-79.

All illuminated push buttons are of the no guard type. To make them a full guard type (does not apply to the KXRN and KXRP operators), add a shroud from page 17-94. If legend inserts must be assembled into the operators, see instructions on page 17-93.

◇ 9001 KX		1	2	3	4	Price
Square Multifunction		(Lens Locations)				
<b>Single and Dual Push Button Codes</b>						
Standard Single Momentary (Non-Illuminated)	RA					\$19.10
Standard Single Momentary (Illuminated) □	RB					19.10
Two Momentary (Non-Illuminated)	RC					38.00
Two Momentary with Interlock (Non-Illuminated)	RD					42.80
Two Maintained with Interlock (Non-Illuminated)	RE					66.00
One Momentary/One Maintained with Interlock (Non-Illuminated)	RF					66.00
Mushroom Single Momentary (Non-Illuminated)	RN					42.80
Mushroom Single Momentary (Illuminated) □	RP					42.80
<b>Push Button &amp; Pilot Light Combination Codes</b>						
Two Momentary Push Buttons with No Interlock and a Single Pilot Light □	RG					47.60
Two Momentary Push Buttons with Interlock and a Single Pilot Light □	RH					57.00
Two Maintained Push Buttons with Interlock and a Single Pilot Light □	RJ					86.00
One Momentary/One Maintained with Interlock and a Single Pilot Light □	RK					38.00
Two Momentary Push Buttons with No Interlock and Dual Pilot Lights △	RL					77.00
Two Momentary Push Buttons with Interlock and Dual Pilot Lights △	RM					105.00
Illuminated Operators Only: Add Voltage Assembly Code	▲					
Non-Illuminated Operators	Blank					N/C
<b>Color Codes ■ ▼</b>						
(Choose one lens color per lens location)						
Leave blank if location does not exist or no lens is required.						
Amber	A	1	1	2		6.60
Black★	B	1	1			6.60
Green	G	2	2	3	4	6.60
Blue	L					6.60
Red	R					6.60
White	W					6.60
No lens color or no location	Blank					N/C
<b>“H” Code Contact Block Assembled to Operator</b>						
No Contact Blocks	Blank					N/C

- ▲ Choose voltage assembly code from page 17-77. Price based on light module chosen.
- ★ For LEDs, match lens color with lamp color (green, red, yellow) or use a white lens. Note: Yellow = Amber
- ◆ Select from “H” code table on page 17-80. Price based on total contact blocks.
- ◆ Black lens not available for Lens 1 on Types KXRN and KXRP and Lens 2 or 3 on Types KXRG, KXRH, KXRJ, KXRL, and KXRM. Non-Illuminated push buttons only. No text available.
- ▼ Lens for Types KXRN and KXRP are \$11.40
- △ Choose voltage assembly code from table on page 17-92. Price based on light module chosen.
- Choose voltage assembly code from table on page 17-77. Price based on light module chosen.
- ◇ For complete operators, see page 17-87. If the desired operator is not listed, then use this table to develop a catalog number.

Dual Dimensions: **INCHES**  
Millimeters

For additional information, reference Catalog #9001CT0001.



**Non-Illuminated and Illuminated 2 Position Selector Switch Operators—  
UL Types 4, 4X, 13/NEMA 4, 4X, 13**

For use in hazardous locations—See page 17-79.  
Legend plate and contact block not included unless noted.

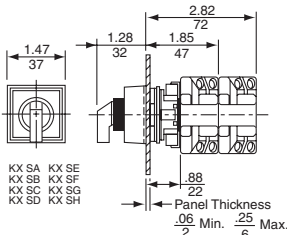

**Selector Switch Operator  
Non-Illuminated**

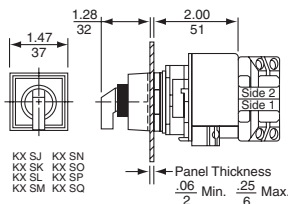

**Selector Switch Operator  
Illuminated**

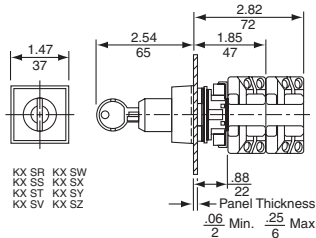

**Key Operator Selector Switch**

Dual Dimensions: **INCHES**  
**Millimeters**

**\* 9001 KX**

**Square Multifunction**

**Selector Switch Codes**

Maintained (Non-Illuminated) Δ	SA	Price
Spring Return from Left to Right (Non-Illuminated)	SB	\$24.20
Spring Return from Right to Left (Non-Illuminated) Δ	SC	43.20
Maintained (Illuminated)	SJ	24.20
Spring Return from Left to Right (Illuminated)	SK	43.20
Spring Return from Right to Left (Illuminated) Δ	SL	43.20
Key Operated—Maintained Δ	SR	89.00
Key Operated—Spring Return from Left to Right	SS	107.00
Key Operated—Spring Return from Right to Left Δ	ST	107.00

**Cam Codes**

(Choose one based on contact closure sequence, refer to page 17-64)

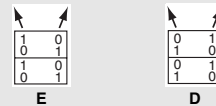

**Illuminated Operator Only:** Add Voltage Assembly Code ▲

**Non-Illuminated Operators or Keyed**

**Blank**

**Key Withdrawal Codes (Keyed Operators Only)**

(Choose one code)	Yes No No Yes	1	N/C
	Yes Yes	2	N/C
		3	N/C

**Color Codes ■**

Amber	A	6.60
Black (Non-Illuminated only)	B	6.60
Green	G	6.60
Blue	L	6.60
Red	R	6.60
White	W	6.60
No Color, Keyed, or Two Color Knob	Blank	N/C

**"H" Code Contact Block Assembled to Operator** ◆

No Contact Blocks	Blank	N/C
-------------------	-------	-----

**Two Color Selector Switch Knob ▼**

Standard	Y178	28.50
Non-Illuminated, Keyed or Not Desired	Blank	N/C

- ▲ Choose voltage assembly code from page 17-77. Price based on light module chosen.
- For LEDs, match lens color with lamp color (green, red, yellow) or use a clear lens. **Note:** Yellow = Amber
- ◆ Select from "H" code table on page 17-80. Maximum contact block usage: 2 blocks mounted in tandem (4 blocks total). Price based on total contact blocks.
- ★ For complete operators, see page 17-87. If the desired operator is not listed, then use this table to develop a catalog number.
- ▼ Two color knobs are used to indicate red in the left position and green in the right position on illuminated operators. **Do not add knob color code when using Form Y178.**
- Δ E Cam Only.

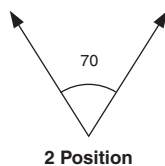

Boots ..... page 17-94  
Contact Blocks and Ratings ..... page 17-78–17-79  
"H" Contact Block Assembly Codes ..... page 17-80  
Legend Inserts ..... page 17-93  
Lockouts ..... page 17-94  
Replacement Parts ..... page 17-94  
Cams ..... page 17-84

For additional information, reference Catalog #9001CT0001.

# Push Buttons—Class 9001 Type KX—30 mm

## Square Multifunction Operator Selector Switches

### Non-Illuminated and Illuminated 3 Position Selector Switch Operators – UL Types 4, 4X, 13/NEMA 4, 4X, 13

For use in hazardous locations—See page 17-79. Legend plate and contact block not included unless noted.



9001KXS

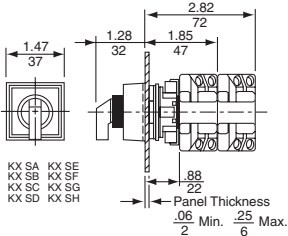

Selector Switch Operator  
Non-Illuminated

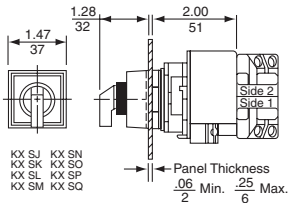

Selector Switch Operator  
Illuminated

Dual Dimensions: **INCHES**  
Millimeters

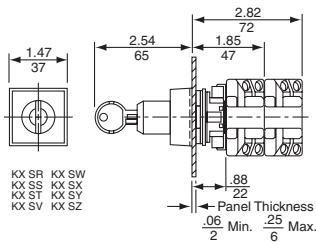

Key Operator Selector Switch

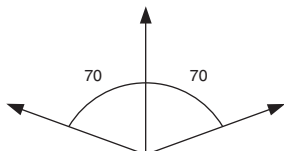

### ▼ 9001 KX

#### Square Multifunction

#### 3 Position Selector Switch Codes

Maintained (Non-Illuminated)	SD	\$24.20
Spring Return Left to Center (Non-Illuminated)	SE	43.20
Spring Return Right to Center (Non-Illuminated)	SF	43.20
Spring Return Both Sides to Center (Non-Illuminated)	SG	43.20
Maintained (Illuminated)	SM	24.20
Spring Return Left to Center (Illuminated)	SN	43.20
Spring Return Right to Center (Illuminated)	SO	43.20
Spring Return Both Sides to Center (Illuminated)	SP	43.20
▲ Key Operated—Maintained	SV	89.00
▲ Key Operated—Spring Return Left to Center	SW	107.00
▲ Key Operated—Spring Return Right to Center	SX	107.00
▲ Key Operated—Spring Return Both Sides to Center	SY	107.00

#### Switch Operation & Cam Codes

(Choose one based on contact closure sequence, refer to page 17-64)

Codes: B	Codes: C	Codes: D	Codes: E	4.20
Codes: F	Codes: G	Codes: J	Codes: L	4.20
Codes: M				4.20
No Cam			Blank	N/C

#### Voltage Assembly or Key Withdrawal Code

Illuminated Operator: Add Voltage Assembly Code

Non-Illuminated Operator

Key Withdrawal Codes

(Keyed Operators Only)

(Choose one code)

Yes	No	No	4	N/C
No	Yes	No	5	N/C
No	No	Yes	6	N/C
Yes	Yes	No	7	N/C
Yes	No	Yes	8	N/C
No	Yes	Yes	9	N/C
Yes	Yes	Yes	10	N/C

#### Knob Color Codes

Amber	A	6.60
Black ▲	B	6.60
Green	G	6.60
Blue	L	6.60
Red	R	6.60
White	W	6.60
No Color, Keyed or Two Color Knob	Blank	N/C

#### "H" Suffix Number for Contact Blocks

No Contact Blocks	Blank	N/C
-------------------	-------	-----

#### Two Color Selector Switch Knob ★

Standard	Y178	28.50
Non-Illuminated, Keyed Operated or Not Desired	Blank	N/C

▲ Not available in illuminated switches.

■ Choose voltage assembly code from page 17-77. For **neon** light modules, use **clear** knob color only. For **LED** light modules, use a knob color that matches the color of the LED (i.e., red LED uses a red knob) or use clear. Price based on light module chosen.

◆ Select from "H" number table on page 17-80. Maximum contact block usage: 2 blocks mounted in tandem (4 blocks total). Price based on total contact blocks.

★ Two color knobs are used to indicate red in the left position and green in the right position on illuminated operators. Do not add a knob color code when using Form Y178.

▼ For complete operators, see page 17-85. If the desired operator is not listed, then use this table to develop a catalog number.

For additional information, reference Catalog #9001CT0001.



**9001KXS**

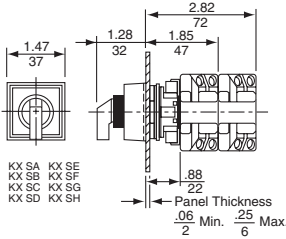

**Selector Switch Operator Non-Illuminated**

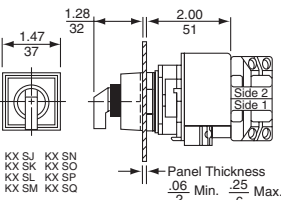

**Selector Switch Operator Illuminated**

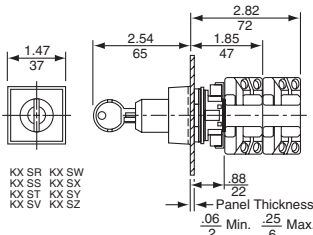

**Key Operator Selector Switch**

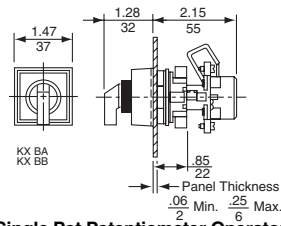

**Single Pot Potentiometer Operator**

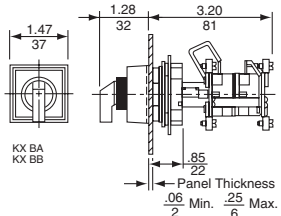

**Double Pot Potentiometer Operator**

**Non-Illuminated and Illuminated 4 Position Selector Switch Operators**

For use in hazardous locations—See page 17-79.

UL Types 4, 4X, 13/NEMA 4, 4X, 13  
Legend plate and contact block not included unless noted.

▲ Not available in illuminated switches.

**★ 9001 KX**

**Square Multifunction**

**Selector Switch Codes**

Maintained (Non-Illuminated)	<b>SH</b>	Price	\$24.20
Maintained (Illuminated)	<b>SQ</b>		24.20
Key Operated—Maintained	<b>SZ</b>		89.00
Cam Codes (Only H Cam is Available, refer to page 17-84)	<b>H</b>		4.20

**Voltage Assembly or Key Withdrawal Code**

Illuminated Operator: Add Voltage Assembly Code ■  
Non-Illuminated Operators Blank N/C

Key Withdrawal Codes  
(Keyed Operators Only)  
(Choose one code)

Yes	No	No	Yes	<b>11</b>	N/C
No	No	No	Yes	<b>12</b>	N/C
Yes	No	No	No	<b>13</b>	N/C
Yes	Yes	Yes	Yes	<b>14</b>	N/C

**Knob Color Codes**

Amber	<b>A</b>	6.60
Black ▲	<b>B</b>	6.60
Green	<b>G</b>	6.60
Blue	<b>L</b>	6.60
Red	<b>R</b>	6.60
White	<b>W</b>	6.60
No Color or Keyed	<b>Blank</b>	N/C

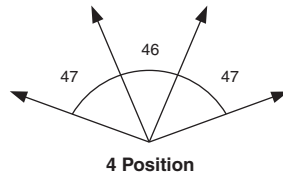

**"H" Suffix Number for Contact Blocks** ◆

No Contact Blocks Blank N/C

- Choose voltage assembly code from page 17-77. For neon light modules, use clear knob color only. For LED light modules, use a knob color that matches the color of the LED (i.e., red LED uses a red knob) or use clear. Price based on light module chosen.
- ◆ Select from "H" number table on page 17-80. Maximum contact block usage: 2 blocks mounted in tandem (4 blocks total). Price based on total contact blocks.
- ★ For complete operators, see page 17-85. If the desired operator is not listed, then use this table to develop a catalog number.

**Potentiometer (With Dial Plate) △ □ (Not UL Listed)**

Watts	Description	Type	Price
2	Operator only—Single Pot	KXBA	\$134.
	Operator with Single Pot	KXBB▼	191.
	Operator only—Tandem Pot	KXBC	209.
	Operator with Tandem Pot	KXBD▼	266.

▼ For complete Type number add suffix number from table below.  
Example: Type KXBB05

Suffix ▼	Ohms	Suffix ▼	Ohms	Suffix ▼	Ohms	Tandem Pots Ohms	
						Front	Rear
01	50	07	5 K	12	250 K	82	1000
02	100	08	10 K	13	500 K	83	5000
38	200	40	15 K	37	750 K	85	10 K
03	250	09	25 K	14	1.1 Meg	88	50 K
04	500	35	35 K	15	2.2 Meg	89	100 K
05	1000	10	50 K	16	5.0 Meg		
32	1500	36	75 K				
39	2000	11	100 K				
06	3200						
33	3500						

△ Dial Plate only—Order Class 9001 Type KXN905. Price \$2.90.  
□ Uses same potentiometer as Class 9001 Type K and SK.

Dual Dimensions: **INCHES**  
**Millimeters**

For additional information, reference Catalog #9001CT0001.



**Legend Plates**

For Push Buttons or Pilot Lights

Marking	Used On						Price
	A	B	C (vertical)	D	E	F	
	KXRA, KXRB, KXRN, KXRP, KXPA, KXPC, KXTA, KXTB, KXTE	KXRC, KXRD, KXRE, KXRF	KXPB, KXTD ◆	KXRG, KXRH, KXRJ, KXRL, KXRM, KXTC ■	KXRG, KXRH, KXRJ, KXRL, KXRM, KXTC ■	KXRL, KXRM, KXTC ▲	
Blank Start Stop On Off Emerg. Stop Forward Reverse Close Open Down Up Jog Reset Run Cycle Start Motor Run Power On	KXN100 KXN101 KXN102 KXN103 KXN104 KXN105 KXN106 KXN107 KXN108 KXN109 KXN110 KXN111 KXN118 KXN123 KXN124 KXN132 KXN136 KXN138	KXN200 KXN201 KXN202 KXN203 KXN204 KXN205 KXN206 KXN207 KXN208 KXN209 KXN210 KXN211 KXN218 KXN223 KXN224 KXN232 KXN236 KXN238	KXN200 KXN201V KXN202V KXN203V KXN204V KXN205V KXN206V KXN207V KXN208V KXN209V KXN210V KXN211V KXN218V KXN223V KXN224V KXN232V KXN236V KXN238V	KXN300 KXN301 KXN302 KXN303 KXN304 KXN305 KXN306 KXN307 KXN308 KXN309 KXN310 KXN311 KXN318 KXN323 KXN324 KXN332 KXN336 KXN338	KXN400 KXN401 KXN402 KXN403 KXN404 KXN405 KXN406 KXN407 KXN408 KXN409 KXN410 KXN411 KXN418 KXN423 KXN424 KXN432 KXN436 KXN438	KXN500 KXN501 KXN502 KXN503 KXN504 KXN505 KXN506 KXN507 KXN508 KXN509 KXN510 KXN511 KXN518 KXN523 KXN524 KXN532 KXN536 KXN538	\$2.90
Special-Marking	KXN199	KXN299	KXN299V	KXN399	KXN499	KXN599	12.30

▲ These legend inserts are for the pilot lights in the center of the operator.  
■ These legend inserts are for the push button portion of the operator.  
◆ These legend inserts have vertical printing.

**For Selector Switches**

Marking	Used On		Price
	KXN-600	KXN-700	
	KXSA, KXSB, KXSC, KXSD, KXSE, KXSF, KXSG, KXSH, KXSJ, KXSK, KXSL, KXSM, KXSN, KXSO, KXSP, KXSQ	KXSR, KXSS, KXST, KXSV, KXSW, KXSX, KXSY, KXSZ	
Blank For.-Rev. Hand-Auto Man-Auto Off-On On-Off Open-Close Start-Stop Auto-Off-Hand Hand-Off-Auto Man-Off-Auto	KXN600 KXN639 KXN640 KXN643 KXN644 KXN645 KXN646 KXN651 KXN658 KXN660 KXN662	KXN700 KXN739 KXN740 KXN743 KXN744 KXN745 KXN746 KXN751 KXN758 KXN760 KXN762	\$2.90
Special Marking	KXN699	KXN799	12.30

Dual Dimensions: **INCHES**  
Millimeters

KXN100 (Pos. 1)	KXN200 (Pos. 1) KXN200 (Pos. 2)	KXN300 (Pos. 1) KXN300 (Pos. 2) KXN300 (Pos. 3)	KXN400 (Pos. 1) KXN-400 (Pos. 2) KXN-400 (Pos. 3) KXN400 (Pos. 4)	KXN-200 (Pos. 1) KXN-200 (Pos. 2)	KXN-200 (Pos. 1) KXN-200 (Pos. 2)
KXRA, KXRB, KXRN, KXRP, KXPA, KXPC, KXTA, KXTB	KXRC, KXRD, KXRE, KXRF	KXRG, KXRH, KXRJ, KXRK	KXRL, KXRM, KXTC	KXPB, KXTD	KXPB, KXTD

**Letter Height For Standard Legends**

	IN	mm
KXN100	1/4	6
KXN200	3/16	4.75
KXN300	3/16	4.75
KXN400	3/16	4.75
KXN500	3/16	4.75
KXN600	1/8	3
KXN700	1/8	3

**Maximum Number of Lines and Characters For Type KXN Legend Inserts**

Letter Height	Number of ...	KXN199	KXN299 Horizontal	KXN299 Vertical	KXN399	KXN499	KXN599
IN	mm						
1/4	6	Characters per Line	7	7	3	7	7
		Lines per Legend Insert	4	2	4	1	1
3/16	4.75	Characters per Line	9	9	4	9	9
		Lines per Legend Insert	5	2	6	2	1
1/8	3	Characters per Line	14	14	5	14	14
		Lines per Legend Insert	8	4	9	3	2

**Maximum Number of Lines and Characters for Type KXN699 and KXN799 Legend Plates**

Position	Letter Height		Characters Per Marking Area	
	IN	mm	A and C	B
	3/16	4.75	6	6
	1/8	3	8	9
	3/16	4.75	10	5
	1/8	3	13	7

All Type KX push buttons and pilot lights have a blank insert as standard. These blank inserts can be custom marked using a marking pen, a mechanical lettering set, press letters, or a tape lettering machine that marks a tape which can then be transferred to the blank insert.

To have legend inserts installed into the operators, order the operator as normal and then indicate where to install the legend inserts using the numbered positions shown on the operator ordered.

Example: 9001KXRL1GRGRH2 with a  
9001KXN 401 in position 1  
9001KXN 503 in position 2  
9001KXN 504 in position 3  
9001KXN 402 in position 4

For additional information, reference Catalog #9001CT0001.

# Push Buttons—Class 9001 Type KX—30 mm

## Accessories



www.SquareD.com

For the most up-to-date information

### Lockout for Push Buttons

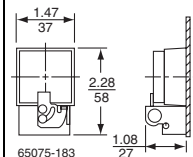
 <p>Holds button in depressed position</p>	 <p>65075-183</p>	<b>Used On</b>	<b>Type</b>	<b>Price</b>
		KXRA-KXRC KXRD-KXRE KXRF-KXRG KXRJ-KXRK KXRL-KXRM KXRH-KXRB	KXAK4	\$28.50

### Closing Plate

 <p>UL Types 4, 13/NEMA 4, 13 Square Closing Plate (Chrome Plated) Same size as KX bezel</p>	<b>Type</b>	<b>Price</b>
	KXAK52	\$9.50

### Boot for Push Buttons and Pilot Lights

 <p>Transparent boot used to exclude harmful contaminants</p>	<b>Used On</b>	<b>Type</b>	<b>Price</b>
	All KX Push Buttons and Pilot Lights	KXAKU7	\$19.10

### Boot For Selector Switches

Description	Used On	Knob Color	Type	Price
 <p>Transparent boot with knob used on selector switches to exclude harmful contaminants</p>	All KX selector switches and potentiometer operators (except key operated)	Black Red Green	KXAKU17B KXAKU17R KXAKU17G	\$28.50

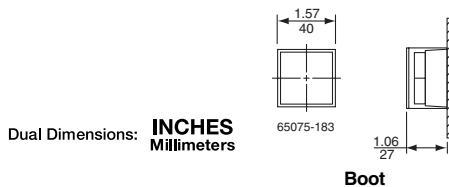

### Shrouds (used to color code Type KX operators)

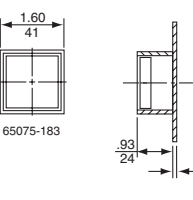
	 <p>65075-183</p> <p>Panel Thickness .06 Min. .25 Max. 2 6</p>	<b>Type</b>	<b>Used On</b>	<b>Color</b>	<b>Type</b>	<b>Price</b>
		Full Shroud	All Push Buttons and Pilot Lights	Gray Red Green Yellow Black Blue	KXAK41E KXAK41R KXAK41G KXAK41Y KXAK41B KXAK41L	\$4.80













Short Shroud	Any KX Operator	Gray Red Green Yellow Black Blue	KXAK40E KXAK40R KXAK40G KXAK40Y KXAK40B KXAK40L	4.80
--------------	-----------------	---	--	------

Liner			Type	Price
			6508900401	N/C

### Lamp and Lens Removal Kit

 <p>Used to remove lamp and lens on all illuminated operators and pilot lights.</p>	<b>Type</b>	<b>Price</b>
	KXALLRT	\$14.30

### Button Covers

Description	For Use on	Color	Type	Code	Price
 <p>Includes 2-KXN200</p>	KXPB KXTD	Red Green Amber Blue White	KXAC28▲ KXAC28▲ KXAC28▲ KXAC28▲ KXAC28▲	R▲ G▲ A▲ L▲ W▲	\$6.60
 <p>Includes KXN400</p>	KXTC (Position 1 & 4)	Red Green Amber Blue White	KXAR4 KXAG4 KXAA4 KXAL4 KXAW4	R G A L W	6.60
 <p>Includes KXN500</p>	KXTC (Position 2 & 3)	Red Green Amber Blue White	KXAR5 KXAG5 KXAA5 KXAL5 KXAW5	R G A L W	6.60
 <p>Includes 1-KXN100</p>	KXPC	Red Green Amber Blue White	KXAC48■ KXAC48■ KXAC48■ KXAC48■ KXAC48■	R◆ G◆ A◆ L◆ W◆	6.60
 <p>Includes KXN100</p>	KXRA KXRB	Red Green Amber Blue White	KXAR1 KXAG1 KXAA1 KXAL1 KXAW1	R G A L W	6.60
 <p>Includes KXN100</p>	KXRN KXRP	Red Green Amber Blue White	KXARM1 KXAGM1 KXAA1 KXALM1 KXAWM1	R G A L W	11.40
 <p>Includes KXN200</p>	KXRC KXRD KXRE KXRF	Red Green Amber Blue White	KXAR2 KXAG2 KXAA2 KXAL2 KXAW2	R G A L W	6.60
 <p>Includes KXN300</p>	KXRG (Position 2) KXRH (Position 2) KXRJ (Position 2) KXRK (Position 2)	Red Green Amber Blue White	KXAR3 KXAG3 KXAA3 KXAL3 KXAW3	R G A L W	6.60
 <p>Includes KXN400</p>	KXRG (Position 1 & 3) KXRH (Position 1 & 3) KXRJ (Position 1 & 3) KXRK (Position 1 & 3) KXRL (Position 1 & 4) KXRM (Position 1 & 4)	Red Green Amber Blue White	KXAR4 KXAG4 KXAA4 KXAL4 KXAW4	R G A L W	6.60
 <p>Includes KXN500</p>	KXRL (Position 2 & 3) KXRM (Position 2 & 3)	Red Green Amber Blue White	KXAR5 KXAG5 KXAA5 KXAL5 KXAW5	R G A L W	6.60
 <p>Includes KXN100</p>	KXPA	Red Green Amber Blue White	KXAR8 KXAG8 KXAA8 KXAL8 KXAW8	R G A L W	6.60
 <p>Includes KXN100</p>	KXTA KXTB	Red Green Amber Blue White	KXAR1 KXAG1 KXAA1 KXAL1 KXAW1	R G A L W	6.60

- ▲ Each KXAC28 includes a clear cover and 1 each of all colors. If the same color is required for position #1 and #2 of the KXPB operator, order 2 of Type KXAC28.
- ▲ When specifying color codes—the first will be installed in #1 and the second in #2. The price for BOTH color codes is \$6.60.
- Each KXAC48 includes a clear cover and 1 each of all colors. If the same color is required for position #1 and #2 of the KXPC operator, order 2 of Type KXAC48.
- ◆ When specifying color codes—the first will be installed in #1, the second in #2, the third in #3 and the fourth in #4. The price for ALL FOUR color codes is \$6.60.
- ★ Two required per operator. When ordering an assembled operator—specify two code numbers. The first code will be assembled into #1 and the second code will be assembled into #2.

For additional information, reference Catalog #9001CT0001.

**Environment**

Degree of protection	Conforming to IEC 529	IP65, unless otherwise stated IP66, for booted push button heads
	Conforming to UL 50, CSA C22.2 No. 94	Type 1, 4X, 12, and 13, unless otherwise stated
Conforming to standards	<b>CE</b> Marked	IEC 947-1, IEC/EN 60947-5-1, IEC 947-5-4, EN 60947-1, JIS C 4520, UL 508, CSA C22.2 No. 14
Product certifications	UL Listed, CSA File E164353 CCN NKCR  File LR 44087 Class 3211 03	Standard single contacts with screw clamp terminals: A600; R300 Light blocks with screw clamp terminals

**Contact Block Characteristics**

**Electrical Characteristics**

Cabling capacity	Conforming to IEC 947-1	Screw and captive clamp terminals Min: 1 x 24 AWG (0.22 mm <sup>2</sup> ) without cable end 1 x 22 AWG (0.34 mm <sup>2</sup> ) for linking Max: 2 x 16 AWG (1.5 mm <sup>2</sup> ) with cable end Cross headed screw (POZIDRIV type 1) slotted for flat 4 and 5.5 mm screwdriver		
Rated operational characteristics Conforming to IEC/EN 60947-5-1	AC supply: Utilization category AC-15	A600: Ue = 600 Vac and Ie = 1.2 A, or Ue = 240 Vac and Ie = 3 A, or Ue = 120 Vac and Ie = 6 A. Continuous thermal current = 10 A.		
	DC supply: Utilization category DC-13	R300: Ue = 250 Vdc and Ie = 0.1 A, or Ue = 125 Vdc and Ie = 0.22 A		
Voltage limits of PROTECTED LED®	Nominal voltage	24 V: 19.2 to 30 Vdc; 21.6 to 24.6 Vac 120 V: 102 to 132 Vac 240 V: 195 to 264 Vac	Voltage limits	Nominal voltage
Current consumption of PROTECTED LED	Applicable to all colors	24 Vac/dc supply blocks: 18 mA 120 Vac supply blocks: 14 mA 240 Vac supply blocks: 14 mA	Current consumption	Applicable to all colors



**XALD101**

**Start or Stop Function (light gray base, RAL7035; dark gray lid, RAL7016)**

Description	Type of Push	Type of Contact		Marking	Catalog Number	Price
		N.O.	N.C.			

**Marking on Legend Holder**

1 momentary push button	Flush black	1	...	Start	XALD101	<b>\$32.80</b>
	Flush red	...	1	Stop	XALD111	<b>32.80</b>



**XALK174**

**Marking on Legend Holder**

1 mushroom head push button Ø 40 mm, momentary	Red	...	1	Emergency stop on red legend	XALD164	<b>38.20</b>
--	-----	-----	---	------------------------------	---------	--------------

**Emergency Stop Function (light gray base, RAL7035; yellow lid, RAL1012)**

Description	Type	Type of Contact		Catalog Number	Price
		N.O.	N.C.		
1 mushroom head push button Ø 40 mm, red Turn-to-release	Standard	...	1	XALK174	<b>\$53.00</b>
	Trigger action	...	1	XALK178	<b>67.00</b>
1 mushroom head push button Ø 40 mm, red Key release (Key No. 455)	Standard	...	1	XALK184	<b>67.00</b>
	Trigger action	...	1	XALK188	<b>67.00</b>
1 mushroom head push button Ø 40 mm, red Push-pull	Standard	...	1	XALK194	<b>44.80</b>



**XALD211**

**Start-Stop Function (light gray base, RAL7035; dark gray lid, RAL7016)**

Description	Type of Push	Type of Contact		Text	Catalog Number	Price
		N.O.	N.C.			

**Text on legend plate**

2 momentary push buttons	1 flush black	1	...	Start	XALD211	<b>\$32.80</b>
	1 flush red	...	1	Stop		
	1 flush black	1	...	Forward	XALD221	<b>32.80</b>
	1 flush black	1	...	Reverse		



**XALD321**

**Three Function (light gray base, RAL7035; dark gray lid, RAL7016)**

Description	Type of Push	Type of Contact		Text	Catalog Number	Price
		N.O.	N.C.			

**Text on push button—no legend plates**

3 momentary push buttons	1 flush black 1 flush red 1 flush black	1	...	Open	XALD341	<b>\$65.</b>
		...	1	Stop		
		1	...	Close		
		1	...	Forward	XALD311	<b>65.</b>
		...	1	Stop		
		1	...	Reverse		
		1	...	Up		
		...	1	Stop	XALD321	<b>65.</b>
		1	...	Down		

For additional information, reference Catalog #9001CT0001.

**XALD02**

**ZENL1111**

**ZALV\*\***

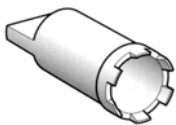
**ZB5SZ3**

**ZB5AZ905**
**Empty Enclosures ▲**

Description	Number of Holes	Catalog Number	Price
<b>For normal environments, CSA approved and UL Listed (with stainless steel lid mounting screws)</b>			
Light gray base RAL7035 Dark gray lid RAL7016	1	XALD01	\$16.40
	2	XALD02	19.10
	3	XALD03	24.50
	4	XALD04	35.50
	5	XALD05	43.70
Light gray base RAL7035 Yellow lid RAL1012	1	XALK01	17.70

**Electrical Block and Accessories (for mounting on metal plate at back of enclosure) ▲**

Description	Type	Color	Catalog Number	Price
<b>Electrical blocks with screw clamp terminal connections</b>				
Standard contact blocks ▲	N.O. contact	...	ZENL1111	\$8.20
	N.C. contact	...	ZENL1121	8.20
Light blocks with <b>Protected LED</b>	24 Vac/dc	White	ZALVB1	25.90
		Green	ZALVB3	
		Red	ZALVB4	
		Yellow	ZALVB5	
		Blue	ZALVB6	
		120 Vac	White	
	Green		ZALVG3	
	Red		ZALVG4	
	Yellow		ZALVG5	
	Blue		ZALVG6	
	230 Vac		White	ZALVM1
		Green	ZALVM3	
		Red	ZALVM4	
		Yellow	ZALVM5	
		Blue	ZALVM6	

Description	Application	Catalog Number	Price
<b>Accessories for electrical blocks</b>			
Blanking plug	Ø 22 mm units	ZB5SZ3	\$5.50
Nut	Head mounting	ZB5AZ901	2.50
Grounding terminal	Grounding	XALZ09	2.70
Key	For tightening nut	ZB5AZ905	6.20

▲ For customer assembly using XB5 operators, see Push Buttons—XB5 22 mm starting on page 17-34.

For additional information, reference Catalog #9001CT0001.



**Glass-reinforced polyester insulated enclosures XAPA**

Material	Glass-reinforced polyester
Approvals	Special version: CSA Type 4 and 5 (undrilled version)
Protective treatment	Standard version: "TC" and "TH" treatments
Ambient temperature	Operation: -25 °C to +70 °C (-13 °F to +158 °F) Storage: -40 °C to +70 °C (-40 °F to +158 °F)
Degree of protection	IP65 conforming to IEC 529 and IP657 conforming to NF C 20-010, Type 4, 4X, 12
Electric shock protection	Class II conforming to IEC 536 and NF C 20-030
Flame resistance	CSTB: M3, NF C 20-455: 850°C; IEC 92: 960 °C; UL 94: VO
Chemical resistance	High degree of resistance to acids, bases, sea water, mineral salts, all solvents, petrol, diesel, oils and greases
Cable entry	Undrilled

**Die Cast metal enclosures XAPG**

Material	Zinc alloy (XAPG1-XAP4), Aluminum (XAPG5)
Approvals	Special version: CSA Type 4 and 5 (undrilled version); UL Type 1, 2, 4, and 12; Standard CSA Type 1, 4, 4X, and 12
Protective treatment	Standard version: "TC" treatment. Special version: "TH" treatment
Ambient temperature	Operation: -25 °C to +70 °C (-13 °F to +158 °F) Storage: -40 °C to +70 °C (-40 °F to +158 °F)
Degree of protection	IP65 conforming to IEC 529 and IP657 conforming to NF C 20-010, UL Type 4, 12
Electric shock protection	Class I conforming to IEC 536 and NF C 20-030
Chemical resistance	Special treatments on request
Cable entry	Tapped entries for cable glands (see dimensions page)

**Flush mount enclosures XAPE**

Material and color	Anodized aluminum front plate. Insulated protective rear cover
Protective treatment	Standard version: "TC" and "TH" treatments
Ambient temperature	Operation: -25 °C to +70 °C (-13 °F to +158 °F) Storage: -40 °C to +70 °C (-40 °F to +158 °F)
Degree of protection	IP65 conforming to IEC 529 and IP657 conforming to NF C 20-010, CSA Type 1, 4, 4X, and 12
Electric shock protection	Class I conforming to IEC 536 and NF C 20-030
Chemical resistance	High degree of resistance to organic acids, diluted mineral acids, salts, alcohol, acetone, chloride and fluoride solvents, oils and petrol
Cable entry	With rear cover: knock-out cable entries



File E164353  
CGN NKCR  
(XAPG only)



File LR 44087  
Class 3211 03



Marked

**Undrilled Enclosures, Glass-Reinforced Polyester**



XAPA1100

Type		H x W Dimensions		Catalog Number	Price
		IN	mm		
NEMA 4, 4X, 13 Usable depth 3.27 in. (83 mm)	Without hinges	3.34 x 5.75	85 x 146	XAPA1100	\$55.00
		3.34 x 8.90	85 x 226	XAPA2100	90.00
	With hinges	5.95 x 9.49	151 x 241	XAPA3100	142.00
		5.95 x 9.49	151 x 241	XAPA4100	189.00
Undrilled Grounding Plate	Sheet steel with ground screw	For XAPA1100		XAPZ100	11.00
		For XAPA2100		XAPZ200	12.30
		For XAPA3100 and 4100		XAPZ300	16.00

**Drilled Insulated Enclosures, Glass-Reinforced Polyester**



XAPA1104

Type	Number of Knockouts 22 mm	Number of Rows		H x W Dimensions		Catalog Number	Price
		Vertical	Horizontal	IN	mm		
NEMA 4, 4X, 13 Usable depth 3.27 in. (83 mm) 1.58 in. (40 mm) centerline spacing of holes	1	1	1	3.35 X 5.75	85 X 146	XAPA1110	\$57.00
	2	1	2	3.35 X 5.75	85 X 146	XAPA1120	57.00
	4	2	2	3.35 X 5.75	85 X 146	XAPA1104	57.00
	8	2	4	3.35 X 8.90	85 X 226	XAPA2108	91.00
	16	4	4	5.94 X 9.49	151 X 241	XAPA3116	195.00
Drilled Grounding Plate	Sheet steel with ground screw	For XAPA1110				XAPZ110	11.00
		For XAPA1120				XAPZ120	11.00
		For XAPA1104				XAPZ104	11.00
		For XAPA2108				XAPZ208	12.30
		For XAPA3116				XAPZ316	16.00

For additional information, reference Catalog #9001CT0001.

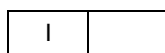

# Push Buttons and Operator Interface

## 22 mm Push Buttons XAP Enclosures



www.SquareD.com

For the most up-to-date information

### Undrilled Die Cast Enclosures (Painted Gray RAL7032)

Type	Material	Usable Depth		H x W x D Dimensions		Catalog Number	Price
		IN	mm	IN	mm		
NEMA 4, 13	Zinc	1.93	49	3.15 x 3.15 x 2.03	80 x 80 x 51.5	XAPG19100	\$55.
				5.12 x 3.15 x 2.03	130 x 80 x 51.5	XAPG29100	60.
				6.89 x 3.15 x 2.03	175 x 80 x 51.5	XAPG39100	71.
		2.93	74.5	3.15 x 3.15 x 3.03	80 x 80 x 77	XAPG19400	55.
				5.12 x 3.15 x 3.03	130 x 80 x 77	XAPG29400	60.
				6.89 x 3.15 x 3.03	175 x 80 x 77	XAPG39400	71.
	Aluminum	2.93	2.93	12.20 x 3.35 x 3.03	310 x 85 x 77	XAPG59400	131.



XAPG39400

### Drilled Die Cast Enclosures (Painted Gray RAL7032)

Type	Material	Usable Depth		Number of 22 mm knockouts	H x W x D Dimensions		Catalog Number	Price	
		IN	mm		IN	mm			
NEMA 4, 13 1.18 in. (30 mm) centerline spacing of holes for horizontal mount	Zinc	1.93	49	2	3.15 x 3.15 x 2.03	80 x 80 x 51.5	XAPG19702	\$60.	
				3	5.12 x 3.15 x 2.03	130 x 80 x 51.5	XAPG29703	71.	
				4	6.90 x 3.15 x 2.03	175 x 80 x 51.5	XAPG39704	87.	
		2.93	74.5	2	3.15 x 3.15 x 3.03	80 x 80 x 77	XAPG19802	60.	
				3	5.12 x 3.15 x 3.03	130 x 80 x 77	XAPG29803	71.	
				4	6.90 x 3.15 x 3.03	175 x 80 x 77	XAPG39804	87.	
NEMA 4, 13 1.58 in. (40 mm) centerline spacing of holes for vertical mount	Zinc	1.93	1.93	1	3.15 x 3.15 x 2.03	80 x 80 x 51.5	XAPG19201	55.	
				2	5.12 x 3.15 x 2.03	130 x 80 x 51.5	XAPG29202	60.	
				3	6.90 x 3.15 x 2.03	175 x 80 x 51.5	XAPG39203	71.	
		2.93	74.5	1	3.15 x 3.15 x 3.03	80 x 80 x 77	XAPG19501	55.	
				2	5.12 x 3.15 x 3.03	130 x 80 x 77	XAPG29502	60.	
				3	6.90 x 3.15 x 3.03	175 x 80 x 77	XAPG39503	71.	
	Aluminum	2.93	74.5	5	8.66 x 3.15 x 3.03	220 x 80 x 77	XAPG49504	87.	
					5	12.20 x 3.35 x 3.03	310 x 85 x 77	XAPG59505	134.



XAPG29703



XAPE302



XAPE303

### Drilled Flush Plates

Type	Material	Number of 22 mm holes	H x W Dimensions		Catalog Number	Price
			IN	mm		
NEMA 4, 13 1.18 in. (30 mm) centerline spacing of holes	Anodized Aluminum	1	2.83 x 2.83	72 x 72	XAPE301	\$26.00
		2	4.13 x 2.83	105 x 72	XAPE302	30.00
		3	5.43 x 2.83	138 x 72	XAPE303	34.20
		4	6.73 x 2.83	171 x 72	XAPE304	41.00
		5	8.03 x 2.83	204 x 72	XAPE305	49.20

### Optional Back Box (for finger protection, if required)

Type	Material	For Use With	Catalog Number	Price
Protective rear covers	Insulating Fiberglass	Flush plate XAPE301	XAPE901	\$16.40
		Flush plate XAPE302	XAPE902	
		Flush plate XAPE303	XAPE903	
		Flush plate XAPE304	XAPE904	
		Flush plate XAPE305	XAPE905	30.00

For additional information, reference Catalog #9001CT0001.

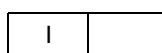

Standard duty control stations are designed for use with magnetic motor starters to govern the starting, stopping, or reversing of all types of electric motors. Push buttons are momentary contact unless otherwise indicated. Selector switches are maintained contact.

**Control Stations**

Many items are stock or can be furnished as a quick ship using a "Universal" station plus accessories.



**NEMA 1 Surface Mounting Type BG201**



**NEMA 1 Flush Mounting (w/o pullbox) Type BF201**



**NEMA 4 Type BW243**



**NEMA 7 and 9 Type BR103**

No. of Units	Nameplate Markings and Features	Contact Symbol See page 17-101	Surface Mounting NEMA 1 ♦		Stainless Steel Flush Plate (Pullbox ■ not included) ♦		Watertight and Dusttight NEMA 4 ♦		For Hazardous Locations Class I, Div. I & II Groups B, C and D Class II Div. I & II Groups E, F and G NEMA 7 & 9 ♦	
			Type	Price	Type	Price	Type	Price	Type	Price
1	Start	1	BG101	\$57.	BF101	\$77.	BW146	\$180.	BR101	\$242.
	Stop	3	BG102	57.	BF102	77.	BW147	180.	BR103	242.
	Stop (Mushroom Button)	3	BG103	66.	...	...	BW151	191.	BR103	252.
	Stop (Lockout)	3	BG104	86.	...	...	BW148	180.	BR104	242.
	Universal (w/o Legend Inserts) ▲	16	BG107	55.	BF107	74.	BW159	179.	BR107	240.
	Off-On (Selector Switch)	19	BG111	57.	BF111	77.	...	...	...	...
	Hand-Off-Auto (Selector Switch)	17	BG112	57.	BF112	77.	...	...	...	...
	Universal Selector Switch (w/o Legend Insert) ▲	19 or 17	BG114	55.	BF114	74.	...	...	...	...
	Red Pilot Light: 120 Vac/dc	121	BG121	134.	BF121	152.	...	...	...	...
	Green Pilot Light: 120 Vac/dc	121	BG122	134.	BF122	152.	...	...	...	...
Pilot Light (w/o Lens): 120 Vac/dc ▲	121	BG123	126.	BF123	146.	...	...	...	...	
2	Start-Stop	145	BG201	57.	BF201	77.	BW240	180.	BR204	242.
	Start-Stop	146	BG202	71.	BF202	90.	BW252	180.	BR202	242.
	Start-Stop (Mushroom on Stop)	145	BG203	66.	...	...	BW250	191.	BR203	252.
	Start-Stop (Lockout on Stop)	145	BG204	86.	...	...	BW241	180.	BR204	242.
	Start-Stop (Mushroom on Start and Stop)	145	BG205	77.	...	...	BW246	200.	BR205	261.
	Forward-Reverse	146	BG206	71.	BF206	90.	BW242	180.	BR206	242.
	Open-Close	146	BG207	71.	BF207	90.	BW244	180.	BR207	242.
	Up-Down	146	BG208	71.	BF208	90.	BW243	180.	BR208	242.
	Raise-Lower	146	BG209	71.	BF209	90.	BW253	180.	BR209	242.
	On-Off	145	BG210	57.	BF210	77.	BW245	180.	BR210	242.
	On-Off	146	BG211	71.	BF211	90.	BW254	180.	BR211	242.
	Universal (w/o Legend Inserts) ▲	25	BG214	52.	BF214	71.	BW260	176.	BR214	237.
	Start-Stop (Maintained Contact)	10	BG215	86.	BF215	105.	BW255	209.	BR215	270.
	On-Off (Maintained Contact)	10	BG216	86.	BF216	105.	BW256	209.	BR216	270.
	Hand-Auto (Maintained Contact)	10	BG217	86.	BF217	105.	BW257	209.	BR217	270.
	Start-Stop (Red Mushroom on Stop, Both Buttons Maintained)	10	...	...	...	...	...	...	BR219	294.
	Universal (Maintained Contact w/o Legend Inserts) ▲	10	BG218	81.	BF218	99.	BW258	204.	BR218	266.
3	Off-On (Selector Switch), Red Pilot Light: 120 Vac/dc	19 & 121	BG221	209.	BF221	228.	▲ "Universal" designates control stations without legend inserts, lenses or accessory kits. Universal stations plus separate legend inserts and other accessories listed on page 17-100 allow the user to conveniently build up standard or custom stations. ■ Use standard 2.0 or 2.13 inch deep wall boxes, single gang for Types BF1_ and BF2_ and two gang for Type BF3_. ♦ For replacement interiors, see page 17-101. Replacement enclosures (case and/or cover) are not available for Type BR devices.  Lockout must be factory installed on NEMA 4 devices. However, replacement covers are available with the lockout feature as standard. See page 17-100.			
	Hand-Off-Auto (Selector Switch), Red Pilot Light: 120 Vac/dc	17 & 121	BG223	209.	BF223	228.				
	Universal Selector Switch & Pilot Light 120 Vac/dc (w/o Legend Insert & w/o Lens) ▲	17 or 19 & 121	BG224	200.	BF224	207.				
	Hand-Off-Auto (Selector Switch) & Start (Push Button)	17 & 1	BG225	86.	BF225	105.				
	Universal Selector Switch & Push Button (w/o Legend Inserts) ▲	17 or 19 & 16	BG226	81.	BF226	99.				
	Fast-Slow-Stop	109	BG301	114.	BF301	138.				
	Forward-Reverse-Stop	109	BG302	114.	BF302	138.				
	Open-Close-Stop	109	BG303	114.	BF303	138.				
	Raise-Lower-Stop	109	BG304	114.	BF304	138.				
	Up-Down-Stop	109	BG305	114.	BF305	138.				
High-Low-Stop	109	BG306	114.	BF306	138.					
Start-Jog-Stop	109	BG316	114.	...	...					
Forward-Reverse-Stop (Lockout on Stop)	109	BG322	143.	...	...					
Up-Down-Stop (Lockout on Stop)	109	BG325	143.	...	...					
High-Low-Stop (Lockout on Stop)	109	BG326	143.	...	...					
Universal (w/o Legend Inserts) ▲	8	BG307	108.	BF307	132.					
Start-Stop, Red Pilot Light: 120 Vac/dc	145 & 121	BG308	209.	BF308	228.					
Universal Push Buttons (2) & Pilot Light: 120 Vac/dc (w/o Legend Inserts & w/o Lens) ▲	25 & 121	BG309	198.	BF309	218.					
Start-Stop (Maintained Contacts) & Red Pilot Light: 120 Vac/dc	10 & 121	BG310	228.	BF310	248.					
On-Off (Maintained Contact) & Red Pilot Light: 120 Vac/dc	10 & 121	BG311	228.	BF311	248.					
Hand-Auto (Maintained Contacts) & Red Pilot Light: 120 Vac/dc	10 & 121	BG312	228.	BF312	248.					
Universal Push Buttons (Maintained Contact) & Pilot Light: 120 Vac/dc (w/o Legend Inserts & w/o Lens) ▲	10 & 121	BG313	218.	BF313	236.					
Hand-Off-Auto (Selector Switch) & Start-Stop (Push Buttons)	17 & 145	BG314	114.	BF314	134.					
Universal Selector Switch & 2 Push Buttons (w/o Legend Inserts) ▲	17 or 19 & 25	BG315	108.	BF315	126.					

For additional information, reference Catalog #9001CT0001.

# Push Buttons—Class 9001 Type B—Accessories

## Standard Duty Control Stations



www.SquareD.com

For the most up-to-date information



Mushroom Caps—Kits do not include legend insert; order separate legend insert from the tables below.

Ex: For red mushroom button marked STOP, order one Class 9001 Type B301 plus one Class 9001 Type B102.

Color	Type	Price
<b>For NEMA 1 surface mounting stations</b>		
Red	B301	\$ 9.50
Black	B302	11.00
<b>For NEMA 4</b>		
Red	B303	9.50



### Replacement Covers for BF and BW

For Types	Types	Price
BF101–BF123	3040000311	\$61.70
BF201–BF226	3040000302	38.00
BF301–BF315	3110104301	61.70
BW146–BW147	BWD108	11.90
BW148▲	BWD109	23.70
BW149–BW159	BWD108	11.90
BW240	BWD219	11.90
BW241▲	BWD220	23.70
BW242–BW260	BWD219	11.90

▲ Replacement cover has factory installed lockout on cover.



Lockout Kit—For NEMA 1 surface mounting stations, bottom unit only. Can be used on either push button or on 2 or 3 position selector switch. Lockout cannot be used with mushroom cap.

Type	Price
B321	\$28.50

### Miscellaneous Accessories

Description	Type	Price
Selector switch knob for types BG & BF selector switches	9001B351	\$ 7.10
Square D lamp (Sylvania lamp 120PSB)	2550105005	11.00
Replacement lamp holder	BGC124	57.00

### Interchangeable Selector Switch Legend Plates

Marking	For NEMA 1 Surface Mounting	For NEMA 1 Flush Mounting	Price Each
	Type	Type	
Off-On	B201	B231	\$2.40
Hand-Off-Auto	B202	B232	
Manual-Auto	B203	B233	
Forward-Reverse	B204	B234	
Open-Close	B205	B235	
Open-Off-Close	B206	B236	
Hand-Auto	B207	B237	
Forward-Off-Reverse	B208	B238	
Summer-Winter	B209	B239	
Summer-Off-Winter	B210	B240	
Low-Off-High	B211	B241	
Up-Off-Down	B212	B242	

Order in multiples of 10 only.

### Legend Insert Kits

(Kit includes one each of standard legend inserts indicated.)

Where Used:	Type	Price
For NEMA 1 Surface Mounting	Push Buttons	B100 (Incl's 1 each of B101 thru B119)
	Selector Switches	B200 (Incl's 1 each of B201 thru B212)
For NEMA 1 Flush Mounting	Push Buttons	B130 (Incl's 1 each of B131 thru B149)
	Selector Switches	B230 (Incl's 1 each of B231 thru B242)
For NEMA 4 and NEMA 7-9 Lever Type, Square	Push Button	B160 (Incl's 1 each of B161 thru B179)
For NEMA 4 Button Type, Round	Push Button	B250 (Incl's 1 each of B253 thru B266)
For NEMA 4 Button Type	Mushroom Button	B300 (Incl's 1 each of B276 thru B289)

### Pilot Light Lenses

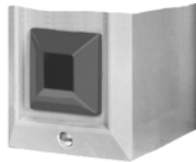

Color	For NEMA 1 Surface Mounting	For NEMA 1 Flush Mounting	Price
	Type	Type	
Red	B331	B341	\$7.10
Green	B332	B342	

### Interchangeable Push Button Legend Inserts

Marking	For NEMA 1 Surface Mounting Push Button & Mushroom Caps	For NEMA 1 Flush Mounting	For NEMA 4 and NEMA 7-9 Lever Type Square	For NEMA 4 Button Type Round	For NEMA 4 Mushroom Button Inserts	Price Each
	Type	Type	Type	Type	Type	
Start	B101	B131	B161	B259	B282	\$2.40
Stop	B102	B132	B162	B260	B283	
Fast	B103	B133	B163	...	...	
Slow	B104	B134	B164	...	...	
Forward	B105	B135	B165	B255	B278	
Reverse	B106	B136	B166	B256	B279	
Open	B107	B137	B167	B263	B286	
Close	B108	B138	B168	B264	B287	
Raise	B109	B139	B169	B261	B284	
Lower	B110	B140	B170	B262	B285	
Up	B111	B141	B171	B253	B276	
Down	B112	B142	B172	B254	B277	
High	B113	B143	B173	...	...	
Low	B114	B144	B174	...	...	
On	B115	B145	B175	B257	B280	
Off	B116	B146	B176	B258	B281	
Hand	B117	B147	B177	B265	B288	
Auto	B118	B148	B178	B266	B289	
Jog	B119	B149	B179	...	...	
Blank-Black	B129	B159	B189	B251	B251	
Blank-Red	B129R	B159R	B189R	B252	B252	

Order in multiples of 10 only.

For additional information, reference Catalog #9001CT0001.



**Type BGC214**  
(Type BGC contact block assemblies include cover.)



**Type BGB214**



**BOC361**

**Replacement Interiors For Type B Standard Duty Push Button Stations**

For Control Station Types	Contact Symbol	Contact Block Assembly ▲ Type	Price	Terminal Block Wiring Receptacle Type	Price
BF101–BF107	16	BOC107	\$26.10	BFB107	\$28.50
BF111–BF114	19 or 17	BOC114	26.10	BFB114	28.50
BF121–BF123	121	BOC123	98.00	BFB123	28.50
BF201–BF214	25	BOC214	23.70	BFB214	28.50
BF215–BF218	10	BOC218	52.00	BFB214	28.50
BF221–BF224	7 or 19 & 121	BOC224	156.00	BFB224	42.80
BF225–BF226	17 or 19 & 16	BOC226	38.00	BFB226	42.80
BF301–BF307	8	BOC214 & BOC107	23.70 26.10	BFB214 & BFB107	28.50 28.50
BF308–BF309	25 & 121	BOC214 & BOC123	23.70 98.00	BFB214 & BFB123	28.50 28.50
BF310–BF313	10 & 121	BOC218 & BOC123	52.00 98.00	BFB214 & BFB123	28.50 28.50
BF314–BF315	17 or 19 & 25	BOC214 & BOC114	23.70 26.10	BFB214 & BFB114	28.50 28.50
BG101–BG107	16	BGC107	26.10	BGB107	28.50
BG111–BG114	17 or 19	BGC114	26.10	BGB114	28.50
BG121–BG123	121	BGC123	98.00	BGB123	28.50
BG201–BG214	25	BGC214	23.70	BGB214	28.50
BG215–BG218	10	BGC218	52.00	BGB214	28.50
BG221–BG224	17 or 19 & 121	BGC224	156.00	BGB224	42.80
BG225–BG226	17 or 19 & 16	BGC226	38.00	BGB226	42.80
BG301–BG307 BG316–BG326	8	BGC307	26.10	BGB307	57.00
BG308–BG309	25 & 121	BGC309	141.00	BGB309	57.00
BG310–BG313	10 & 121	BGC313	161.00	BGB309	57.00
BG314–BG315	17 or 19 & 25	BGC315	49.80	BGB315	57.00
BR101–BR107	16	BOC107	26.10	BFB107	28.50
BR202–BR214	25	BOC214	23.70	BFB214	28.50
BR215–BR219	10	BOC218	52.00	BFB214	28.50
BW101–BW107	16	BOC107	26.10	BFB107	28.50
BW202–BW214	25	BOC214	23.70	BFB214	28.50
BW215–BW218	10	BOC218	52.00	BFB214	28.50
BW146–BW159	16	BOC360	84.00		
BW240–BW260	25	BOC361	84.00		
BW255–BW258	10	BOC362	84.00		

**Note:** Contact block assemblies for all Type BG stations include cover and contact block. Replacement contact block assemblies and terminal block wiring receptacles for push buttons have provision for 1 N.O. & 1 N.C. circuit on each button. Unneeded circuits need not be wired.

▲ Order separate legend plates, if required, from listing on page 17-100.

“C” Shaped Mounting Bracket for 9001BR Interior

3110112001	Price
	\$4.80

**Electrical Contact Ratings**

AC—NEMA B600						DC—NEMA P600			
Volts	Inductive 35% Power Factor				Continuous Carrying Amperes	Resistive 75% Power Factor	Volts	Inductive and Resistive	
	Make		Break					Make and Break Amperes	Continuous Carrying Amperes
	Amps	VA	Amps	VA					
120	30.5	3600	3.75	360	5	5	120	1.1	5
240	15	3600	1.5	360	5	5	240	.55	5
480	7.5	3600	.75	360	5	5	480	.2	5
600	6	3600	.6	360	5	5	600		

**Contact Symbols**

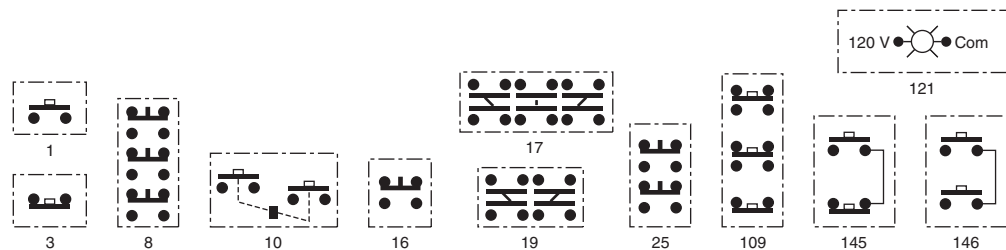

For additional information, reference Catalog #9001CT0001.

# Push Buttons—Class 9001 Type KY and SKY—30 mm

## Industrial Duty Enclosures



Type KYAF9

### Enclosures Only (For Customer Assembly)

No. of Units	UL Types 1, 3 and 13/NEMA 1, 3 and 13				UL Types 1, 3, 4 and 13 NEMA 1, 3, 4 and 13 ▲		UL Types 1, 3, 4, 4X and 13 NEMA 1, 3, 4, 4X and 13 ▲			
	Surface Mounting		Flush Mounting without Pullbox ♦ ★		Surface Mounting		Surface Mounting			
	Sheet Steel		Cast Zinc		Die Cast Aluminum ★		Stainless Steel (304) ▼		Polymeric (Plastic)	
	Type	Price	Type	Price	Type	Price	Type	Price	Type	Price
1	KYAF1	\$ 95.	KZ11	\$ 57.	KY1	\$ 95.	KYSS1	\$ 171.	SKY1	\$ 114.
2	KYAF2	105.	KZ21 ■	57.	KY2 ■	105.	KYSS2	180.	SKY2	134.
3	KYAF3	123.	KZ31 ■	66.	KY3 ■	123.	KYSS3	248.	SKY3	152.
4	KYAF4	152.	KZ41 ■	95.	KY4 ■	152.	KYSS4	323.	SKY4	179.
6	KYAF6	191.	KZ6	134.	KY6	191.	KYSS6	476.	SKY6	362.
9	KYAF9	248.	KZ9	180.	Not Available	Not Available	KYSS9	588.	SKY9	476.
12	KYAF12	333.	KZ12	257.	KY12	333.	KYSS12	713.	SKY12	546.
16	KYAF16	428.	KZ16	351.	KY16	428.	KYSS16	941.	SKY16	617.
20	KYAF20	531.	Not Available	Not Available	Not Available	Not Available	KYSS20	1044.	SKY20	713.
25	KYAF25	654.	Not Available	Not Available	Not Available	Not Available	KYSS25	1329.	SKY25	831.
30	KYAF30	783.	Not Available	Not Available	Not Available	Not Available	KYSS30	1566.	Not Available	

Custom Built Control Stations are available. Consult Catalog #9001CT0001.

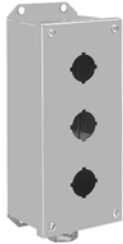

Type KYSS3

No. of Units	UL Types 1, 3 and 13/NEMA 1, 3 and 13				UL Types 1, 3, 4 and 13 NEMA 1, 3, 4 and 13 ▲		UL Types 1, 3, 4, 4X and 13 NEMA 1, 3, 4, 4X and 13 ▲			
	Surface Mounting		Flush Mounting without Pullbox ♦ ★		Surface Mounting		Surface Mounting			
	Sheet Steel		Cast Zinc		Die Cast Aluminum ★		Stainless Steel (304) ▼		Polymeric (Plastic)	
	Type	Price	Type	Price	Type	Price	Type	Price	Type	Price
1	KYAF100	\$ 95.	KZ110	\$ 57.	KY10	\$ 95.	KYSS100	\$ 171.	SKY100	\$ 114.
2	KYAF200	105.	KZ210 ■	57.	KY20 ■	105.	KYSS200	180.	SKY200	134.
3	KYAF300	123.	KZ310 ■	66.	KY30 ■	123.	KYSS300	248.	SKY300	152.
4	KYAF400	152.	KZ410 ■	95.	KY40 ■	152.	KYSS400	323.	SKY400	179.
6	KYAF600	191.	KZ60	134.	KY60	191.	KYSS600	476.	SKY600	362.
9	KYAF900	248.	KZ90	180.	KY90	248.	KYSS900	588.	SKY900	476.
12	KYAF1200	333.	KZ120	257.	KY120	333.	KYSS1200	713.	SKY1200	546.
16	KYAF1600	428.	KZ160	351.	KY160	428.	KYSS1600	941.	SKY1600	617.
20	KYAF2000	531.	Not Available	Not Available	Not Available	Not Available	KYSS2000	1044.	SKY2000	713.
25	KYAF2500	654.	Not Available	Not Available	Not Available	Not Available	KYSS2500	1329.	SKY2500	831.
30	KYAF3000	783.	Not Available	Not Available	Not Available	Not Available	KYSS3000	1566.	Not Available	

▲ Type K Series A through Series G operators were rated NEMA 1, 3, 12, and 13. Type K Series H operators are rated UL Types 1, 3, 4, 6, 12 and 13/ NEMA 1, 3, 4, 6, 12, and 13.

■ Only KN200 series legend plates will fit upright on these enclosures with their long axis vertical.

♦ For machine cavity mounting. Pull box not available.

★ Type KN1, KN6 and KN7 series legend plates will not fit on these enclosures.

▼ Standard Type KYSS enclosures are supplied with Type 304 stainless steel—Type 316 stainless steel is available (25% price adder)—Specify Form Y35 and order by description.



Type KY3

Note: For closing plates, see page 17-83.



Type KZ31



Type KZ310



Type KYAF900



Type SKY2

For additional information, reference Catalog #9001CT0001.

**Control Stations**

Enclosures have sufficient depth to accommodate two contact blocks in tandem (total of four blocks) on non-illuminated operators and two contact blocks side-by-side on illuminated operators.

**Assembled Control Stations—UL Types 1, 3, 4 and 13/NEMA 1, 3, 4 and 13 ▲  
Die Cast Aluminum Enclosures**



Type KYK31

No of Units	Legend Plate Marking And Features	Type	Price	Consists of			
				Enclosure	Operators	Contact Blocks	Legend Plates
1	Hand-Off-Auto (Selector Switch)	KYK111	\$162.	KY1	KS43B	KA1	KN260
	Hand-Off-Auto (Sel. Switch) (With Sealed Contacts)	KYK121 ■	228.	KY1	KS43B	KA51	KN260
	Jog-Run (Selector Switch)	KYK18	162.	KY1	KS11B	KA1	KN242
	Off-On (Selector Switch)	KYK110	162.	KY1	KS11B	KA1	KN244
	Off-On (Selector Switch) (With Sealed Contacts)	KYK122 ■	228.	KY1	KS11B	KA51	KN244
	Red 120 Vac Pilot Light	KYK120 ■	180.	KY1	KP1R31	...	...
	Start	KYK11	152.	KY1	KR1B	KA1	KN201
	Start (With Sealed Contacts)	KYK125 ■	219.	KY1	KR1B	KA51	KN201
	Start (Mushroom Button)	KYK12	180.	KY1	KR4B	KA1	KN201
	Stop	KYK13	152.	KY1	KR1R	KA1	KN202
	Stop (Mushroom Button)	KYK14	180.	KY1	KR4R	KA1	KN202
	Stop (With Lockout)	KYK15	180.	KY1	KR3R,K4	KA1	KN202
	Stop (With Sealed Contacts and Lockout)	KYK124 ■	248.	KY1	KR3R,K4	KA51	KN202
	Stop Mushroom (With Sealed Contacts and Lockout)	KYK123 ■	276.	KY1	KR4R,K4	KA51	KN202
	To Stop—Break Glass	KYK116	219.	KY1	K15	KA1	KN799RP
	To Stop—Break Glass (Red Enclosure)	KYK117	219.	KY1S1	K15	KA1	KN799RP
	2	Forward-Reverse	KYK24	219.	KY2	KR1B,KR1B	KA1,KA1
Jog-Stop (Lockout on Stop)		KYK224	248.	KY2	KR1B,KR3R,K4	KA1,KA1	KN218,KN202
On-Off		KYK218	219.	KY2	KR1B,KR3R	KA1,KA1	KN203,KN204
On-Off (With Sealed Contacts)		KYK222 ■	351.	KY2	KR1B,KR3R	KA51,KA51	KN203,KN204
On-Off (Maintained Contact)		KYK221	219.	KY2	KR11GR	KA1	KN203,KN204
Open-Close		KYK26	219.	KY2	KR1B,KR1B	KA1,KA1	KN209,KN208
Start-Stop		KYK21	219.	KY2	KR1B,KR3R	KA1,KA1	KN201,KN202
Start-Stop (With Sealed Contacts)		KYK223 ■	351.	KY2	KR1B,KR3R	KA51,KA51	KN201,KN202
Start-Stop (Lockout on Stop)		KYK23	248.	KY2	KR1B,KR3R,K4	KA1,KA1	KN201,KN202
Start-Stop (Maintained Contact)		KYK27	219.	KY2	KR11GR	KA1	KN201,KN202
Start-Stop (With Maintained Sealed Contacts)		KYK220 ■	285.	KY2	KR11GR	KA51	KN201,KN202
Start-Stop (Mushroom on Stop)		KYK22	248.	KY2	KR1B,KR4R	KA1,KA1	KN201,KN202
Up-Down	KYK25	219.	KY2	KR1B,KR1B	KA1,KA1	KN211,KN210	
3	Forward-Reverse-Start-Stop	KYK35	305.	KY3	KS11B,KR1B,KR3R	KA1,KA1,KA1	KN239,KN201,KN202
	Forward-Reverse-Stop	KYK31	294.	KY3	KR1B,KR1B,KR3R	KA1,KA1,KA1	KN206,KN207,KN202
	Forward-Reverse-Stop (Lockout on Stop)	KYK326	323.	KY3	KR1B,KR1B,KR3R,K4	KA1,KA1,KA1	KN206,KN207,KN202
	Forward-Reverse-Stop (With Sealed Contacts and Lockout on Stop)	KYK322 ■	522.	KY3	KR1B,KR1B,KR3R,K4	KA51,KA51,KA51	KN206,KN207,KN202
	High-Low-Stop	KYK34	294.	KY3	KR1B,KR1B,KR3R	KA1,KA1,KA1	KN214,KN215,KN202
	Jog/Run-Start-Stop	KYK36	305.	KY3	KS11B,KR1B,KR3R	KA1,KA1,KA1	KN242,KN201,KN202
	Open-Close-Stop	KYK33	294.	KY3	KR1B,KR1B,KR3R	KA1,KA1,KA1	KN209,KN208,KN202
	Open-Close-Stop (Lockout on Stop)	KYK327	323.	KY3	KR1B,KR1B,KR3R,K4	KA1,KA1,KA1	KN209,KN208,KN202
	Open-Close-Stop (With Sealed Contacts and Lockout on Stop)	KYK323 ■	522.	KY3	KR1B,KR1B,KR3R,K4	KA51,KA51,KA51	KN209,KN208,KN202
	Red 120 Vac Pilot Light-Start-Stop	KYK317	314.	KY3	KP1R31,KR1B,KR3R	KA2,KA3	KN200,KN201,KN202
	Red 120 Vac Pilot Light-Start-Stop (With Sealed Contacts)	KYK321 ■	456.	KY3	KP1R31,KR1B,KR3R	KA51,KA51	KN200,KN201,KN202
	Red 120 Vac/dc Pilot Light-Start-Stop	KYK324	323.	KY3	KP38R31,KR1B,KR3R	KA1,KA1	KN200,KN201,KN202
	Up-Down-Stop	KYK32	294.	KY3	KR1B,KR1B,KR3R	KA1,KA1,KA1	KN211,KN210,KN202
	Up-Down-Stop (Lockout on Stop)	KYK325	323.	KY3	KR1B,KR1B,KR3R,K4	KA1,KA1,KA1	KN211,KN210,KN202
	Up-Down-Stop (With Sealed Contacts and Lockout on Stop)	KYK328 ■	522.	KY3	KR1B,KR1B,KR3R,K4	KA51,KA51,KA51	KN211,KN210,KN202

▲ Control stations are UL Listed for use in areas classified as Class II Division 2 Group G and Class III.  
■ Control station consists of components that are UL Listed for use in Class I, Division 2, Groups A, B, C or D.



Type KYSS300\*



Type SKY201\*

\*See page 17-104 for selection and pricing.

Standard Assembled Control Stations. . . . . page 17-103–17-104  
Custom Assembled Control Stations. . . . . page 17-102  
Dimensions. . . . . Catalog #9001CT0001

For additional information, reference Catalog #9001CT0001.

# Push Buttons—Class 9001 Type KY and SKY—30 mm

## Control Stations for Types K and KY

### Assembled Control Stations—UL Types 1, 3, 4, and 13/NEMA 1, 3, 4 and 13▲

No. of Units	Legend Plate Marking and Features	Type	Price	Consists of			
				Enclosure	Operators	Contact Blocks	Legend Plates
1	Start	KYSS101	\$228.	KYSS1	KR1B	KA1	KN101WP
	Stop	KYSS103	213.	KYSS1	KR1B	KA3	KN102RP
	Stop (Lockout)	KYSS105	261.	KYSS1	KR3R with K5	KA3	KN102RP
	Off/On (Selector Switch)	KYSS110	237.	KYSS1	KS11B	KA1	KN144WP
	Hand/Off/Auto (Selector Switch)	KYSS111	237.	KYSS1	KS43B	KA1	KN160WP
2	Start/Stop	KYSS201	281.	KYSS2	KR1B, KR3R	KA1, KA3	KN101WP, KN102RP
	Start/Stop (Lockout on Stop)	KYSS203	327.	KYSS2	KR1B, KR3R with K5	KA1, KA3	KN101WP, KN102WP
	Up/Down	KYSS205	294.	KYSS2	KR1B, KR1B	KA1, KA1	KN111WP, KN110WP
	Start/Stop (Maintained Contact)	KYSS210	294.	KYSS2	KR11U	KA1, KA1	KN101WP, KN102WP
3	Forward/Reverse/Stop	KYSS301	404.	KYSS3	KR1B, KR1B, KR3R	KA1, KA1, KA3	KN106WP, KN107WP, KN102RP
	Up/Down/Stop	KYSS302	404.	KYSS3	KR1B, KR1B, KR3R	KA1, KA1, KA3	KN111WP, KN110WP, KN102RP
	Open/Close/Stop	KYSS303	404.	KYSS3	KR1B, KR1B, KR3R	KA1, KA1, KA3	KN109WP, KN108WP, KN102RP
	High/Low/Stop	KYSS304	404.	KYSS3	KR1B, KR1B, KR3R	KA1, KA1, KA3	KN114WP, KN115WP, KN102RP
	Forward/Reverse/Stop (Lockout on Stop)	KYSS308	452.	KYSS3	KR1B, KR1B, KR3R w/K5	KA1, KA1, KA3	KN106WP, KN107WP, KN102RP
	Up/Down/Stop (Lockout on Stop)	KYSS309	452.	KYSS3	KR1B, KR1B, KR3R w/K5	KA1, KA1, KA3	KN111WP, KN110WP, KN102RP
	Open/Close/Stop (Lockout on Stop)	KYSS310	452.	KYSS3	KR1B, KR1B, KR3R w/K5	KA1, KA1, KA3	KN109WP, KN108WP, KN102RP
	High/Low/Stop (Lockout on Stop)	KYSS311	452.	KYSS3	KR1B, KR1B, KR3R w/K5	KA1, KA1, KA3	KN114WP, KN115WP, KN102RP

### Assembled Control Stations—UL Types 1, 3, 4, 4X and 13/NEMA 1, 3, 4, 4X, and 13▲

No. of Units	Legend Plate Marking and Features	Type	Price	Consists of			
				Enclosure	Operators	Contact Blocks	Legend Plates
1	Start	KYSK101	\$228.	KYSS1	SKR1B	KA1	KN101WP
	Stop	KYSK103	213.	KYSS1	SKR3R	KA3	KN102RP
	Stop (Lockout)	KYSK105	261.	KYSS1	SKR3R with K5	KA3	KN102RP
	Off/On (Selector Switch)	KYSK110	237.	KYSS1	SKS11B	KA1	KN144WP
	Hand/Off/Auto (Selector Switch)	KYSK111	237.	KYSS1	SKS43B	KA1	KN160WP
2	Start/Stop	KYSK201	281.	KYSS2	SKR1B, SKR3R	KA1, KA3	KN101WP, KN102RP
	Start/Stop (Lockout on Stop)	KYSK203	327.	KYSS2	SKR1B, SKR3R with K5	KA1, KA3	KN101WP, KN102WP
	Up/Down	KYSK205	294.	KYSS2	SKR1B, SKR1B	KA1, KA1	KN111WP, KN110WP
	Start/Stop (Maintained Contact)	KYSK210	294.	KYSS2	SKR11U	KA1, KA1	KN101WP, KN102WP
3	Forward/Reverse/Stop	KYSK301	404.	KYSS3	SKR1B, SKR1B, SKR3R	KA1, KA1, KA3	KN106WP, KN107WP, KN102RP
	Up/Down/Stop	KYSK302	404.	KYSS3	SKR1B, SKR1B, SKR3R	KA1, KA1, KA3	KN111WP, KN110WP, KN102RP
	Open/Close/Stop	KYSK303	404.	KYSS3	SKR1B, SKR1B, SKR3R	KA1, KA1, KA3	KN109WP, KN108WP, KN102RP
	High/Low/Stop	KYSK304	404.	KYSS3	SKR1B, SKR1B, SKR3R	KA1, KA1, KA3	KN114WP, KN115WP, KN102RP
	Forward/Reverse/Stop (Lockout on Stop)	KYSK308	452.	KYSS3	SKR1B, SKR1B, SKR3R w/K5	KA1, KA1, KA3	KN106WP, KN107WP, KN102RP
	Up/Down/Stop (Lockout on Stop)	KYSK309	452.	KYSS3	SKR1B, SKR1B, SKR3R w/K5	KA1, KA1, KA3	KN111WP, KN110WP, KN102RP
	Open/Close/Stop (Lockout on Stop)	KYSK310	452.	KYSS3	SKR1B, SKR1B, SKR3R w/K5	KA1, KA1, KA3	KN109WP, KN108WP, KN102RP
	High/Low/Stop (Lockout on Stop)	KYSK311	452.	KYSS3	SKR1B, SKR1B, SKR3R w/K5	KA1, KA1, KA3	KN114WP, KN115WP, KN102RP

### Assembled Control Stations—UL Types 1, 3, 4, 4X and 13/NEMA 1, 3, 4, 4X, and 13▲

No. of Units	Legend Plate Marking and Features	Type	Price	Consists of			
				Enclosure	Operators	Contact Blocks	Legend Plates
1	Hand-Off-Auto (Sel. Switch with Sealed Contacts)	SKY121 ■	\$249.	SKY1	SKS43B	KA51	KN160WP
	Hand-Off-Auto (Selector Switch)	SKY111	180.	SKY1	SKS43B	KA1	KN160WP
	Jog	SKY107	171.	SKY1	SKR1B	KA1	KN118WP
	Man-Auto (Selector Switch)	SKY108	180.	SKY1	SKS11B	KA1	KN143WP
	Off-On (Selector Switch with Sealed Contacts)	SKY122 ■	248.	SKY1	SKS11B	KA51	KN144WP
	Off-On (Selector Switch)	SKY110	180.	SKY1	SKS11B	KA1	KN144WP
	Start	SKY101	171.	SKY1	SKR1B	KA1	KN101WP
	Start (With Sealed Contacts)	SKY125 ■	237.	SKY1	SKR1B	KA51	KN101WP
	Stop	SKY103	156.	SKY1	SKR3R	KA3	KN102RP
	Stop (With Lockout)	SKY105	204.	SKY1	SKR3R, K5	KA3	KN102RP
Stop (With Sealed Contacts and Lockout)	SKY124 ■	285.	SKY1	SKR3R, K5	KA51	KN102RP	
2	Forward-Reverse	SKY204	248.	SKY2	SKR1B, SKR1B	KA1, KA1	KN106WP, KN107WP
	On-Off	SKY222 ■	380.	SKY2	SKR1B, SKR3R	KA51, KA51	KN103WP, KN104RP
	Open-Close	SKY206	248.	SKY2	SKR1B, SKR1B	KA1, KA1	KN109WP, KN108WP
	Start-Stop	SKY201	233.	SKY2	SKR1B, SKR3R	KA1, KA3	KN101WP, KN102RP
	Start-Stop (Lockout on Stop)	SKY203	281.	SKY2	SKR1B, SKR1R, K5	KA1, KA3	KN101WP, KN102RP
3	Start-Stop (With Maintained Sealed Contacts)	SKY220 ■	314.	SKY2	SKR11GR	KA51	KN101WP, KN102RP
	Start-Stop (With Sealed Contacts)	SKY223 ■	380.	SKY2	SKR1B, SKR3R	KA51, KA51	KN101WP, KN102RP
	Up-Down	SKY205	248.	SKY2	SKR1B, SKR1B	KA1, KA1	KN111WP, KN110WP
	Forward-Reverse-Stop	SKY301	309.	SKY3	SKR1B, SKR1B, SKR3R	KA1, KA1, KA3	KN106WP, KN107WP, KN102RP
	Forward-Reverse-Stop (With Sealed Contacts and Lockout on Stop)	SKY322 ■	522.	SKY3	SKR1B, SKR1B, SKR3R	KA51, KA51, KA51	KN106WP, KN107WP, KN102RP
	High-Low-Stop	SKY304	309.	SKY3	SKR1B, SKR1B, SKR3R	KA1, KA1, KA3	KN114WP, KN115WP, KN102RP
	Open-Close-Stop	SKY303	309.	SKY3	SKR1B, SKR1B, SKR3R	KA1, KA1, KA3	KN109WP, KN108WP, KN102RP
	Open-Close-Stop (With Sealed Contacts)	SKY323 ■	522.	SKY3	SKR1B, SKR1B, SKR3R	KA51, KA51, KA51	KN109WP, KN108WP, KN102RP
	Red 120 Vac Pilot Light-Start-Stop	SKY315A	354.	SKY3	SKP1R31, SKR1B, SKR3R	KA1, KA3	KN101WP, KN102RP
	Start-Jog-Stop	SKY305	309.	SKY3	SKR1B, SKR1B, SKR3R	KA1, KA1, KA3	KN101WP, KN118WP, KN102RP
Up-Down-Stop	SKY302	309.	SKY3	SKR1B, SKR1B, SKR3R	KA1, KA1, KA3	KN111WP, KN110WP, KN102RP	
Up-Down-Stop (With Sealed Contacts and Lockout on Stop)	SKY328 ■	522.	SKY3	SKR1B, SKR1B, SKR3R	KA51, KA51, KA51	KN111WP, KN110WP, KN102RP	

▲ Control Stations are UL Listed for use in areas classified as Class II Division 2 Group G and Class III.  
■ Control Stations are UL Listed for use in areas classified as Class I Division 2 Groups A, B, C and D.

For additional information, reference Catalog #9001CT0001.



**Stainless Steel NEMA 1 Flush Plates ▲**

These flush plates accept Type K, SK, KX and T operators and contact blocks and may be used with a standard 2" x 3" general purpose switch box. A 2½" deep box should be used with two Type K contact blocks mounted side by side. If two Type K contact blocks mounted in tandem are needed, a 3½" deep box should be used. Although oiltight/watertight operators are used, an assembled station using the flush plates is **not oiltight/watertight**. The kits include the stainless steel flush plate, cover screws and a set of liners. The liners must be used to maintain electrical clearance.



Two Unit

No. of Units	Description	Type	Price
1	1 Unit flush plate, cover screws, insulating liners	K25	\$19.10
2	2 Unit flush plate, cover screws, insulating liners	K26	28.50
3	3 Unit flush plate, cover screws, insulating liners	K27	38.00
4	4 Unit flush plate, cover screws, insulating liners	K28	57.00

▲ Center to center of operators is 1<sup>13</sup>/<sub>16</sub>".

**General Purpose NEMA 1 Flush Mounting Control Station With Pull Box For Type K Control Units**



Type KY192

Number of Units	Enclosure Only For Customer Assembly		Custom Built Factory Assembled Control Stations	
	Type	Price	Type	Price
1	KZP1	\$123.	KZP10	\$123.
2	KZP2	143.	KZP20	143.
3	KZP3	180.	KZP30	180.
4	KZP4	191.	KZP40	191.
5	KZP5	228.	KZP50	228.
6	KZP6	237.	KZP60	237.
7	KZP7	314.	KZP70	314.
8	KZP8	323.	KZP80	323.

Special Features		Price
<b>Type 304 Stainless steel flush plate (Form Y242):</b>		
No. of Units:		<b>Add</b>
1-4 .....		\$208.
5-8 .....		265.
<b>Omit Pull Box (Form Y243):</b>		<b>Deduct</b>
No. of Units:		
1-2 .....		57.
3-4 .....		77.
5-6 .....		95.
7-8 .....		114.

**30 mm Security Control Stations**



Type KZC299

Description	Type of Cylinder	Cylinder Finish	Special Features	Cast Aluminum Enclosure ■		Satin Chrome Finish Flush Mounted with Box	
				Type	Price	Type	Price
Spring Return Key Operator Only	Corbin	Chrome	Complete with Core ♦ (6 Tumbler Pins) Lock Cylinder Only—Core Omitted★ (6 Tumbler Pins) Complete with Core ♦ (7 Tumbler Pins) Lock Cylinder Only—Core Omitted★ (7 Tumbler Pins) Maximum Security Cylinder	KY198	\$356.	KZC198	\$452.
	Yale	Brass		KY199	356.	KZC199	452.
	Best	Chrome		KY197	498.	KZC197	594.
	Best	Chrome		KY196	428.	KZC196	522.
	Best	Chrome		KY195	498.	KZC195	594.
	Best	Chrome		KY194	428.	KZC194	522.
Spring Return Key Operator with Stop Button	Schlage	Chrome	Complete with Core ♦ (6 Tumbler Pins) Lock Cylinder Only—Core Omitted★ (6 Tumbler Pins) Complete with Core ♦ (7 Tumbler Pins) Lock Cylinder Only—Core Omitted★ (7 Tumbler Pins) Maximum Security Cylinder	KY193	356.	KZC193	452.
	Sargent	Chrome		KY192	594.	KZC192	689.
	Corbin	Chrome		KY298	428.	KZC298	522.
	Yale	Brass		KY299	428.	KZC299	522.
	Best	Chrome		KY297	570.	KZC297	665.
	Best	Chrome		KY296	498.	KZC296	594.
	Best	Chrome	KY295	570.	KZC295	665.	
	Best	Chrome	KY294	498.	KZC294	594.	
	Schlage	Chrome	KY293	428.	KZC293	522.	
	Sargent	Chrome	KY292	665.	KZC292	759.	

■ Meets NEMA 3R requirements.  
♦ When Best Lock stations are supplied with core, customer should contact local Best Lock representative to change core.  
★ When Best Lock stations are supplied without core, customers must purchase core separately from Best Lock, and customers can subsequently change core at their convenience.

**Contact your nearest Square D/Schneider Electric sales office if:**

- Master keying is required.
- Station is to be keyed to a specific key number.
- Extra keys are required.
- Keying several stations alike is required.
- Nonstandard legend plates are required.
- A specific type of keyway is required.

**Repair Parts**

**Replacement or duplicate keys:** Corbin, Yale, or Schlage—local distributor, hardware store, or lock shop that duplicates keys. Square D can supply at \$9.50 each and delivery is 5 weeks. Best—must purchase from local Best Lock representative. Sargent—must purchase from Square D. Keys supplied with our security control station are registered to the Square D Company. Price is \$23.70 each and delivery is 5 weeks.

Replacement enclosures are not sold. Replacement core or cylinders are not sold.

**Electrical Ratings**

**Key Operator:** One Class 9007 Type AO2 snap switch is used for the OPEN position and one snap switch is used for the CLOSE position. See page 19-37 for electrical ratings of the 9007AO2.

**Stop Button:** One Class 9001 Type KA1 contact block is used on the optional push button. See page 17-78 for 9001KA1 electrical ratings. (Note: The KA1 contact block has a maximum voltage rating of 300 V (NEMA A300) when used in the Type KZC station.)

For additional information, reference Catalog #9001CT0001.

**Pilot Lights, Push-To-Test and Remote Test Pilot Lights**

Class 9001 Type J compact pilot lights are designed to be mounted in a 0.69" (1 1/16") diameter mounting hole. Each terminal accepts up to two #14 AWG wires (CU only). Type J compact pilot lights meet NEMA 4 (watertight) and NEMA 13 (oiltight). Type JT push-to-test pilot lights have contacts built into the encapsulated body. Type JTR remote test pilot lights have dual inputs for one push remote testing—all you need is a push button with a current rating equal to or greater than the total lamp draw. Type JTR remote test pilot lights can also be energized from two separate input signals of the same voltage and polarity. This is done by wiring the "test" terminal to the second input signal.

**Standard Pilot Light▲**



Type JP1R29

Style/Voltage	Color Cap						Lamp	Replacement Lamp	Price
	None	Price	Red	Green	Yellow	Price			
Transformer/ 110–120 V, 50–60 Hz	JP1	\$95.	JP1R29	JP1G29	JP1Y29	\$102.	6.3 V, .15 A	2550101020	\$8.30
Incandescent/120 Vac/dc	JP38	77.	JP38R29	JP38G29	JP38Y29	84.	120 V, .015 A	2550101040	8.30
Incandescent/24–28 Vac/dc	JP35	77.	JP35R29	JP35G29	JP35Y29	84.	28 V, .040 A	2550101024	8.30
LED/24–28 Vac	...	...	JP35LRR29	JP35LGG29	JP35LYY29	102.	28 V, .03 A		
LED/24–28 Vdc	...	...	JP35DRR29	JP35DGG29	JP35DYY29	102.	28 V, .03 A		
LED/120 Vac	...	...	JP38LRR29	JP38LGG29	JP38LYY29	102.	28 V, .03 A		

**Push-To-Test Pilot Light▲**

Style/Voltage	Color Cap						Lamp	Replacement Lamp	Price
	None	Price	Red	Green	Yellow	Price			
Transformer/ 110–120 V, 50–60 Hz	JT1	\$123.	JT1R29	JT1G29	JT1Y29	\$130.	6.3 V, .15 A	2550101020	\$8.30
Incandescent/120 Vac/dc	JT38	105.	JT38R29	JT38G29	JT38Y29	112.	120 V, .015 A	2550101040	8.30
Incandescent/24–28 Vac/dc	JT35	105.	JT35R29	JT35G29	JT35Y29	112.	28 V, .040 A	2550101024	8.30
LED/24–28 Vac	...	...	JT35LRR29	JT35LGG29	JT35LYY29	130.	28 V, .03 A		
LED/24–28 Vdc	...	...	JT35DRR29	JT35DGG29	JT35DYY29	130.	28 V, .03 A		
LED/120 Vac	...	...	JT38LRR29	JT38LGG29	JT38LYY29	130.	28 V, .03 A		

**Remote Test Pilot Light▲**



Type JTR1R29

Style/Voltage	Color Cap						Lamp	Replacement Lamp	Price
	None	Price	Red	Green	Yellow	Price			
Transformer/ 110–120 V, 50–60 Hz	JTR1	\$143.	JTR1R29	JTR1G29	JTR1Y29	\$150.	6.3 V, .15 A	2550101020	\$8.30
Incandescent/120 Vac	JTR38	123.	JTR38R29	JTR38G29	JTR38Y29	130.	120 V, .015 A	2550101040	8.30
Incandescent/24–28 Vac	JTR35	123.	JTR35R29	JTR35G29	JTR35Y29	130.	28 V, .040 A	2550101024	8.30
LED/24–28 Vac	...	...	JTR35LRR29	JTR35LGG29	JTR35LYY29	150.	28 V, .03 A		

▲ Other voltages are available. Contact local field offices for details.

**Color Caps, Class 9001 Type J**

Color	Replacement Color Caps			
	Plastic	Price	Glass	Price
Red	R29	\$7.00	R26	\$7.00
Green	G29		G26	
Amber	A29		A26	
Blue	L29		L26	
Clear	C29		C26	
White	W29		W26	
Yellow	Y29		Y26	

**Legend Plates**

Description	Maximum Number of Lines	Maximum Number of Characters	Type	Price
	Blank	Black Field Red Field	JN100 JN100R	\$2.90
	Special Marking (Specify Marking)	Black Field Red Field		
	Blank	Aluminum Field	JN700 JN799	2.90
	Special Marking (Specify Marking)	Aluminum Field		



File 25490C  
Guide 184 N 13.1U



File E42259  
Guide NKCR

For additional information, reference Catalog #9001CT0001.



Type O

**Instrument Type Incandescent Pilot Lights—Type O NEMA 13**

Voltage AC/DC	Avg. Current (A)	Red Lens Type	Green Lens Type	Amber Lens Type	Clear Lens Type	Yellow Lens Type	White Lens Type	Fluted Blue Lens Type	Price
12 V	.170	OR12	OG12	OA12	OC12	OY12	OW12	FB12	<b>\$19.10</b>
24 V	.073	OR24	OG24	OA24	OC24	OY24	OW24	FB24	
120 V	.025	OR120	OG120	OA120	OC120	OY120	OW120	FB120	



File E179183 Guide 001X

**Replacement Lamps—Class 9001, Type O**

Voltage	Sylvania Lamp Number	Square D Part Number	Square D Price
12 V	12PSB	2550105003	<b>\$11.00</b>
24 V	24PSB	2550105004	
120 V	120PSB	2550105005	



XVLA1\*\*

**XVL Miniature LED**

<b>Conforming to standards</b>	IEC 337-2, NF C 63-140, VDE 0660-200
<b>Degree of protection</b>	IP40 (IP65 with seal) conforming to IEC 529 and NF C 20-010
<b>Current consumption</b>	25 mA
<b>Cabling</b>	XVLA1**, XVLA2**: tags for 2.8 x 0.5 mm Faston connectors, also for soldered connections. XVLA3**: threaded connectors, clamping, capacity: min. 1 x 0.2 mm <sup>2</sup> , max. 1 x 1.5 mm <sup>2</sup>

**With Black Bezel, Raised LED**



XVLA2\*\*

Description	Supply Voltage DC	Color	Catalog Number	Price Each
Ø 8 mm ▲ with integral ballast resistor and reverse polarity protection diode Degree of protection IP40 LED pilot lights Ø 8 mm, with black bezel, visible LED XVLA1**	5 V	Green Red Orange-yellow	XVLA113 XVLA114 XVLA115	<b>\$16.40</b>
	12 V	Green Red Orange-yellow	XVLA123 XVLA124 XVLA125	
	24 V	Green Red Orange-yellow	XVLA133 XVLA134 XVLA135	
	48 V	Green Red Orange-yellow	XVLA143 XVLA144 XVLA145	

**With Integral Lens Cap, Covered LED**



XVLA3\*\*

Description	Supply Voltage DC	Color	Catalog Number	Price Each
Ø 8 mm ▲ with integral ballast resistor and reverse polarity protection diode Degree of protection IP40 Ø 8 mm, with lens incorporated, LED XVLA2	5 V	Green Red Orange-yellow	XVLA213 XVLA214 XVLA215	<b>\$16.40</b>
	12 V	Green Red Orange-yellow	XVLA223 XVLA224 XVLA225	
	24 V	Green Red Orange-yellow	XVLA233 XVLA234 XVLA235	
	48 V	Green Red Orange-yellow	XVLA243 XVLA244 XVLA245	
Ø 12 mm ■ with integral ballast resistor and reverse polarity protection diode Degree of protection IP40 Ø 12 mm, with lens incorporated, LED XVLA3	5 V	Green Red Orange-yellow	XVLA313 XVLA314 XVLA315	<b>26.00</b>
	12 V	Green Red Orange-yellow	XVLA323 XVLA324 XVLA325	
	24 V	Green Red Orange-yellow	XVLA333 XVLA334 XVLA335	
	48 V	Green Red Orange-yellow	XVLA343 XVLA344 XVLA345	

▲ Quick connects (2.8 x 0.5 mm).  
■ Screw termination.

**Accessories**



XVLX\*\*

Description	Catalog Number	Price Each
Tightening tools (Sold singly)	For Ø 8 mm pilot lights: XVLX08 For Ø 12 mm pilot lights: XVLX12	<b>\$ 9.30</b> <b>12.00</b>
Seals (IP65) (Sold in lots of 10)	For Ø 8 mm pilot lights: XVLZ911 For Ø 12 mm pilot lights: XVLZ912	<b>0.65</b>



XVLZ91\*\*

For additional information, reference Catalog #9001CT0001.

# Push Buttons and Operator Interface

## XVB Illuminated Beacons and Indicating Banks

### XVB Characteristics



**XVBL3\***



**XVBL4B\***



**XVBL6B\***  
5 Joule



**XVBL8B\***  
10 Joule

#### Environment

Approvals	Standard version, CSA, UL File E164353 CCN NKCR  File LR 44087 Class 3211 03	UL E164353 CCN NKCR, CSA LR 44087 Class 3211 03
Conforming to standards	Marked	IEC/EN 60947-5-1, UL 508, CSA 22.2 No. 14
Degree of protection	To IEC 529 and NF C 20-010 To UL 50 and CSA 22.2 No. 94	IP65 Type 1, 4X (indoor), and 12

#### Electrical Characteristics

Consumption	LED unit	
	Steady	24 Vac/dc: < 80 mA; 120-230 Vac: < 30 mA.
	Flashing	24 Vac or 24 Vdc: < 40 mA; 120-230 Vac: < 15 mA.
	Unit with strobe (on energization)	24 Vac or 24 Vdc: 5 Joule unit: < 430 mA; 10 Joule unit: < 850 mA 120 Vac: 5 Joule unit: < 130 mA; 10 Joule unit: < 260 mA 230 Vac: 5 Joule unit: < 105 mA; 10 Joule unit: < 210 mA
	Audible sounder units	12-48 Vac/dc: < 20 mA 120-230 Vac: < 50 mA
Cable size	Maximum wire size	1 x #16 AWG (1.5 mm <sup>2</sup> ) with cable end
Terminals	Screw and captive cable clamp terminals Torque to 4.4 in-lb (0.5 N•m)	

#### Illuminated Beacons with Steady Light (2.75 in./70 mm diameter)

Description	Light Source and Voltage	Color	Catalog Number	Price
Complete unit, includes: 1 lens unit 1 base unit (direct or tube mounting)	Bulb (10 W max) not included 250 V max	Green	XVBL33	\$76.
		Red	XVBL34	
		Orange	XVBL35	
		Blue	XVBL36	
		Clear	XVBL37	
		Yellow	XVBL38	

#### Illuminated Beacons with Flashing Light (2.75 in./70 mm diameter)

Description	Light Source and Voltage	Color	Catalog Number	Price
Complete unit, includes: 1 lens unit 1 base unit (direct or tube mounting)	Bulb (10 W max) not included 24 Vac 24-48 Vdc	Green	XVBL4B3	\$129.
		Red	XVBL4B4	
		Orange	XVBL4B5	
		Blue	XVBL4B6	
		Clear	XVBL4B7	
		Yellow	XVBL4B8	
		Bulb (10 W max) not included 48-230 Vac	Green	
	Red		XVBL4M4	
	Orange		XVBL4M5	
	Blue		XVBL4M6	
	Clear		XVBL4M7	
	Yellow		XVBL4M8	

For bulbs, see page 17-110.

#### Illuminated Beacons with 10 Joule Strobe (2.75 in./70 mm diameter)

Description	Light Source and Voltage	Color	Catalog Number ▲	Price		
Complete unit, includes: 1 lens unit 1 base unit (direct or tube mounting)	Strobe 24 Vac/dc	Green	XVBL8B3	\$244.		
		Red	XVBL8B4			
		Orange	XVBL8B5			
		Blue	XVBL8B6			
		Clear	XVBL8B7			
		Yellow	XVBL8B8			
		Strobe 120 Vac	Green		XVBL8G3	244.
			Red		XVBL8G4	
	Orange		XVBL8G5			
	Blue		XVBL8G6			
	Clear		XVBL8G7			
	Yellow		XVBL8G8			
	Strobe 230 Vac		Green	XVBL8M3	244.	
			Red	XVBL8M4		
		Orange	XVBL8M5			
		Blue	XVBL8M6			
		Clear	XVBL8M7			
		Yellow	XVBL8M8			

▲ For 5 Joule units, specify XVBL6\*\*, instead of XVBL8\*\* (\$190.00).  
Note: There are no replacement lenses for strobes.

For additional information, reference Catalog #9001CT0001.



**XVCB3\***

**Illuminated Lens Units with Steady Light (2.75 in./70 mm diameter)**

Description	Light Source and Voltage	Color	Catalog Number	Price
Illuminated lens unit	Bulb (10 W max) not included 250 Vac/dc max	Green	XVBC33	\$40.40
		Red	XVBC34	
		Orange	XVBC35	
		Blue	XVBC36	
		Clear	XVBC37	
		Yellow	XVBC38	



**XVCB4\*\***

**Illuminated Lens Unit with Flashing Light (2.75 in./70 mm diameter)**

Description	Light Source and Voltage	Color	Catalog Number	Price		
Illuminated lens unit	Bulb (10 W max) not included 24 Vac 24-48 Vdc	Green	XVBC4B3	\$94.00		
		Red	XVBC4B4			
		Orange	XVBC4B5			
		Blue	XVBC4B6			
		Clear	XVBC4B7			
		Yellow	XVBC4B8			
		Bulb (10 W max) not included 48-230 Vac	Green		XVBC4M3	94.00
			Red		XVBC4M4	
	Orange		XVBC4M5			
	Blue		XVBC4M6			
	Clear		XVBC4M7			
	Yellow		XVBC4M8			

For bulbs, see page 17-110.



**XVCB6\*\*  
5 Joule**

**Illuminated Lens Units with 10 Joule Strobe (2.75 in./70 mm diameter)**

Description	Light Source and Voltage	Color	Catalog Number ▲	Price
Illuminated lens units	Strobe 24 Vac/dc	Green	XVBC8B3	\$209.00
		Red	XVBC8B4	
		Orange	XVBC8B5	
		Blue	XVBC8B6	
		Clear	XVBC8B7	
		Yellow	XVBC8B8	
	Strobe 120 Vac	Green	XVBC8G3	209.00
		Red	XVBC8G4	
		Orange	XVBC8G5	
		Blue	XVBC8G6	
		Clear	XVBC8G7	
		Yellow	XVBC8G8	
	Strobe 230 Vac	Green	XVBC8M3	209.00
		Red	XVBC8M4	
		Orange	XVBC8M5	
		Blue	XVBC8M6	
		Clear	XVBC8M7	
		Yellow	XVBC8M8	

▲ For 5 Joule units, specify XVCB6\*\*, instead of XVCB8\*\* (\$155.00).

Note: There are no replacement lenses units for the XVBC strobe.



**XVCB8\*\*  
10 Joule**

**Audible Sounder Units (2.75 in./70 mm diameter)**

Description	Supply Voltage	Catalog Number	Price
Sounder unit 90 dB at 1 m Adjustable from 75-90 dB Continuous or intermittent modes	12-48 Vac/dc	XVBC9B	\$145.00
	120-230 Vac	XVBC9M	228.00



**XVCB9\***

**Base Units + Cover (for direct or tube mounting, 2.75 in./70 mm diameter)**

Description	For use with	Type	Catalog Number	Price
Base unit + cover for bottom or side cable entry	Banks	Standard	XVBC21	\$40.40



**XVBC21  
(cover not shown)**

For additional information, reference Catalog #9001CT0001.



**XVBC02**

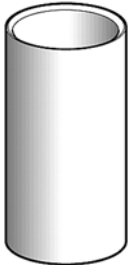

**XVBC020**

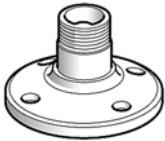

**XVBC11**

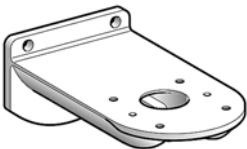

**XVBC12**

**Accessories Common to Beacon and Indicating Banks**

Description	Characteristics		Catalog Number	Price
	IN	mm		
Support tube	3.94	100	XVBC02	\$12.20
	15.75	400	XVBC03	23.00
	31.50	800	XVBC04	33.70
Support tube concealment cover	3.94	100	XVBC020	7.80
	15.75	400	XVBC030	23.00
	31.50	800	XVBC040	41.40
Mounting tulip with gasket	For mounting on tube XVBC0*		XVBC11	16.10
Wall mount bracket	For direct mounting on base unit or with tulip XVBC11 + tube XVBC0*		XVBC12	32.30
Incandescent bulbs bayonet type BA 15d, 10 W	12 Vac/dc		DL1BLJ	5.40
	24 Vac/dc		DL1BLB	
	48 Vac/dc		DL1BLE	
	120 Vac/dc		DL1BLG	
	230 Vac/dc		DL1BLM	
Incandescent bulbs bayonet type BA 15d, 7 W	12 Vac/dc		DL1BEJ	5.40
	24 Vac/dc		DL1BEB	
	48 Vac/dc		DL1BEE	
	120 Vac/dc		DL1BEG	
	230 Vac/dc		DL1BEM	
LEDs bayonet type BA 15d (sold singly)	24 Vac/dc	White	DL1BDB1	72.00
		Green	DL1BDB3	
		Red	DL1BDB4	
		Blue	DL1BDB6	
	120 Vac	Yellow-orange	DL1BDB8	72.00
		White	DL1BDG1	
		Green	DL1BDG3	
		Red	DL1BDG4	
Adapter for side entry through base unit	With CM12 (pg 13.5) cable gland, for cable size of 0.4 to 0.55 in. (10 to 14 mm) diameter		XVBC14	5.20
	Conduit adapter		1/2" NPT (for customer supplied tubing)	XVBC00

**Accessories Specific to Indicating Banks**

Description	Characteristics	Catalog Number	Price
Set of colored markers	6 colors	XVBC22	\$2.10
Set of 5 legend holders	Identification of stacked units on base	XVBC23	8.30
Sheet of 85 legends for legend holder (XVBC23)	Identification of stacked units on base	XVBCY1	3.10
Sheet of 52 legends	Identification of stacked units on locking ring	XVBCY2	3.10

**Wiring Diagrams, Base Units**

**Screw terminals**  
 Torque to 4.4 in-lb (0.5 N•m)

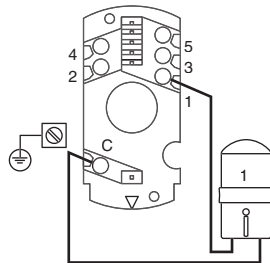

**2 x #16 AWG (1.5 mm<sup>2</sup>)**  
**1 x #14 AWG (2.5 mm<sup>2</sup>)**

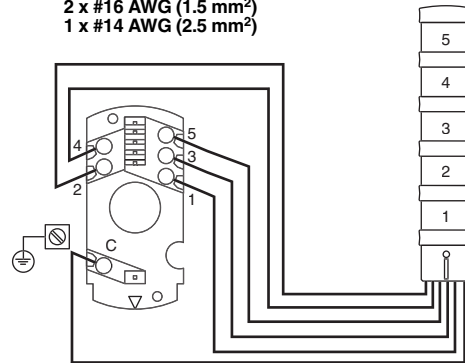

For additional information, reference Catalog #9001CT0001.

The XVDLS miniature illuminated beacons are designed for short distance signalling applications.



XVDLS\*\*

**Environment**

Approvals	Standard version, CSA, UL File E164353 CCN NKCR  File LR 44087 Class 3211 03	UL E164353 CCN NKCR, CSA LR 44087 Class 3211-03
Conforming to standards	Marked	IEC/EN 60947-5-1, UL 508, CSA C22.2 No. 14
Degree of protection	To UL 50, CSA C22.2 No. 94 To IEC 529 and NF C 20-010	Type 1 IP40
Cable size	Maximum wire size	1 x #16 AWG (1.5 mm <sup>2</sup> ) with cable end
Terminals	Screw and captive cable clamp terminals Torque to 4.4 in-lb (0.5 N•m)	

**Note:** The XVDL miniature illuminated beacon is designed for a maximum 5 W bulb.

**Illuminated Beacons with Steady Light (1.75 in./45 mm diameter)**

Description	Light Source	Color	Catalog Number	Price
Complete unit, includes: 1 lens unit 1 base unit (direct mounting)	Incandescent bulb (5 W max) ▲ not included 250 V max	Green	XVDLS33	<b>\$33.10</b>
		Red	XVDLS34	
		Orange	XVDLS35	
		Blue	XVDLS36	
		Clear	XVDLS37	
		Yellow	XVDLS38	

▲ Bulb type for use with direct supply: BA 15d base fitting, incandescent. Maximum lamp size is 5 W.

**Illuminated Beacons with 0.5 Joule Strobe (1.75 in./45 mm diameter)**

Description	Light Source	Color	Catalog Number	Price
Complete unit, includes: 1 lens unit 1 base unit (direct mounting)	Strobe 24 Vac/dc	Green	XVDLS6B3	<b>\$83.00</b>
		Red	XVDLS6B4	
		Orange	XVDLS6B5	
		Blue	XVDLS6B6	
		Clear	XVDLS6B7	
		Yellow	XVDLS6B8	
	Strobe 120 Vac	Green	XVDLS6G3	<b>83.00</b>
		Red	XVDLS6G4	
		Orange	XVDLS6G5	
		Blue	XVDLS6G6	
		Clear	XVDLS6G7	
		Yellow	XVDLS6G8	
	Strobe 230 Vac	Green	XVDLS6M3	<b>83.00</b>
		Red	XVDLS6M4	
		Orange	XVDLS6M5	
		Blue	XVDLS6M6	
		Clear	XVDLS6M7	
		Yellow	XVDLS6M8	

**Accessories**

Description	Supply Voltage	Color	Catalog Number	Price
Incandescent bulbs bayonet type BA 15d (sold in lots of 10)	24 Vac/dc, 4 watts	...	DL1BEB5	<b>\$ 4.10</b>
	120 Vac/dc, 5 watts	...	DL1BEGS	
	230 Vac/dc, 5 watts	...	DL1BEMS	
LEDs bayonet type BA 15d (sold singly)	24 Vac/dc	White	DL1BDB1	<b>72.00</b>
		Green	DL1BDB3	
		Red	DL1BDB4	
		Blue	DL1BDB6	
		Yellow-orange	DL1BDB8	
	120 Vac	White	DL1BDG1	<b>72.00</b>
		Green	DL1BDG3	
		Red	DL1BDG4	
		Blue	DL1BDG6	
		Yellow-orange	DL1BDG8	

For additional information, reference Catalog #9001CT0001.

# Push Buttons and Operator Interface

## XVR Rotating Lights



XVR1\*\*\*

### Environment

Approvals	Standard version, CSA, UL (Pending)	
Degree of protection	To IEC 529 and NF C 20-010 To UL 50 and CSA 22.2 No. 94	IP65 Type 4X (indoor)
Consumption	Halogen	24 Vac/dc: < 3100 mA
	Incandescent	24 Vac/dc: < 1050 mA 120 Vac: < 210 mA 230 Vac: < 110 mA
Bulb type	Halogen	H1, maximum power 70 W
	Incandescent	Bayonet type BA 15d, maximum power 25 W
Wire size	Maximum wire size	1 x #16 AWG (1.5 mm <sup>2</sup> ) with cable end

### Rotating Mirror Beacon (6.5 in./165 mm diameter)

Light Source	Supply Voltage	Color	Catalog Number	Price
Halogen bulb 70 W	24 Vac/dc	Green	XVR1B93	\$185.
		Red	XVR1B94	
		Orange	XVR1B95	
		Blue	XVR1B96	
		Yellow	XVR1B98	
Incandescent bulb 25 W	24 Vac/dc	Green	XVR1B03	168.
		Red	XVR1B04	
		Orange	XVR1B05	
		Blue	XVR1B06	
	120 Vac	Yellow	XVR1B08	197.
		Green	XVR1G03	
		Red	XVR1G04	
		Orange	XVR1G05	
230 Vac	Blue	XVR1G06	197.	
	Yellow	XVR1G08		
	Green	XVR1M03		
	Red	XVR1M04		
		Orange	XVR1M05	197.
		Blue	XVR1M06	
		Yellow	XVR1M08	





### Accessories and Spare Parts

Description	Characteristics	Catalog Number	Price
Domed replacement lens unit	Green	XVR0153	\$65.00
	Red	XVR0154	
	Orange	XVR0155	
	Blue	XVR0156	
	Yellow	XVR0158	
Protective grill for domed lens unit	...	XVR016	21.50
Wall mount bracket for vertical surface	...	XVR012	21.50
Mounting tulip for tube (1/2" NPT)	...	XVR013	17.60
Halogen bulbs, H1, 70 W	24 Vac/dc	DL1BRBH	36.00
Incandescent bulbs bayonet type BA 15d, 25 W (sold in lots of 10)	24 Vac/dc	DL1BRB	14.00
	120 Vac	DL1BRG	14.00
	230 Vac	DL1BRM	14.00

For additional information, reference Catalog #9001CT0001.



**Environment**

Approvals	UL Listed, CSA Certified  File E164353 CCN NKCR	 File LR 44087 Class 3211 03	 File E164353 CCN NKCR 2
Conforming to standards	 Marked	IEC/EN 60947-5-1, UL 508	
Protective Treatment	"TC"		
Degree of protection	To IEC 60529 and NF C 20-010 To UL 50 and CSA 22.2 No. 94	IP65 Type 1, 12 and 13	

**Electrical Characteristics**

Consumption	LED unit	24 Vac/dc: < 60 mA; 120–230 Vac: < 20 mA
	Steady incandescent bulb 7 W	24 Vac/dc: < 300 mA; 120–230 Vac: 65–35 mA
	Flashing	24 Vac or 24 Vdc: < 250 mA; 120–230 Vac: < 30 mA
	Unit with strobe (on energization)	24 Vdc: 0.3 Joules, 40 mA; 120 Vac: 0.6 Joules, 20 mA; 230 Vac: 0.6 Joules, 11 mA
	Audible sounder units	24 Vdc, 12 mA; 120 Vac, 15 mA; 230 Vac, 15 mA
Cable size	Maximum wire size	2 x #16 AWG (1.5 mm <sup>2</sup> ) with cable end
Terminals	Torque requirement	Removable and captive screw terminals: 4.4 in-lb (0.5 N•m)

**Components**

**Base Units with Cover (for direct or tube mounting)**

Description	Color	For use with Indicating Banks	Catalog Number	Price
50 mm base unit	Black	50 mm diameter only	XVPC21	\$32.
50 mm base unit	Off-white	50 mm diameter only	XVPC21W	
50 mm base unit with ring-tongue compatible terminal		50 mm diameter only	XVPC21WR	



**XVPC21**

**Illuminated Lens Units**

Description	Ring Color	Light Source and Voltage	Lens Color	Catalog Number	Price
50 mm steady lens unit (See part numbers under "LEDs" on page 17-114 to select steady or flashing mode)	Black	Bulb (7 W max) not included 250 V max	Green Red Amber Blue Clear Yellow	XVPC33 XVPC34 XVPC35 XVPC36 XVPC37 XVPC38	\$29.
	Off-white	Bulb (7 W max) not included 250 V max	Green Red Amber Blue Clear Yellow	XVPC33W XVPC34W XVPC35W XVPC36W XVPC37W XVPC38W	29.



**Lens Unit with Black Ring**

**Strobe**

50 mm strobe lens unit	Black	Strobe 24 Vdc 0.3 Joule	Green Red Amber Blue Clear Yellow	XVPC6B3 XVPC6B4 XVPC6B5 XVPC6B6 XVPC6B7 XVPC6B8	124.
		Strobe 120 Vac 0.6 Joule	Green Red Amber Blue Clear Yellow	XVPC6G3 XVPC6G4 XVPC6G5 XVPC6G6 XVPC6G7 XVPC6G8	
	Off-white	Strobe 24 Vdc 0.3 Joule	Green Red Amber Blue Clear Yellow	XVPC6B3W XVPC6B4W XVPC6B5W XVPC6B6W XVPC6B7W XVPC6B8W	
		Strobe 120 Vac 0.6 Joule	Green Red Amber Blue Clear Yellow	XVPC6G3W XVPC6G4W XVPC6G5W XVPC6G6W XVPC6G7W XVPC6G8W	



**XVPC09B**

**Audible Sounder Units**

Description	Ring Color	Supply Voltage	Catalog Number	Price
50 mm sounder unit (IP40 NEMA 1)	Black	24 Vdc 120 Vac 230 Vac	XVPC09B XVPC09G XVPC09M	\$104.
Ten tone selections, 75–85 dB at 1 m	Off-white	24 Vdc 120 Vac 230 Vac	XVPC09BW XVPC09GW XVPC09MW	

For additional information, reference Catalog #9001CT0001.

# Push Buttons and Operator Interface

## XVP 50 mm Illuminated Indicating Banks

### Accessories



www.SquareD.com

For the most up-to-date information



DL1BEJ



DL1BDB1



XVPC12



XVPC02



XVPC03T  
(With Base and Lenses)

### LEDs

Description	Voltage	Color	Catalog Number	Price
Steady-On LEDs <b>Protected LED</b>	24 Vac/dc	White Green Red Blue Yellow/Amber	DL1BDB1 DL1BDB3 DL1BDB4 DL1BDB6 DL1BDB8	\$72.
	120 Vac	White Green Red Blue Yellow/Amber	DL1BDG1 DL1BDG3 DL1BDG4 DL1BDG6 DL1BDG8	
	230 Vac	White Green Red Blue Yellow/Amber	DL1BDM1 DL1BDM3 DL1BDM4 DL1BDM6 DL1BDM8	
Flashing LEDs <b>Protected LED</b>	24 Vac/dc	White Green Red Blue Yellow/Amber	DL1BKB1 DL1BKB3 DL1BKB4 DL1BKB6 DL1BKB8	93.
	120 Vac	White Green Red Blue Yellow/Amber	DL1BKG1 DL1BKG3 DL1BKG4 DL1BKG6 DL1BKG8	
	230 Vac	White Green Red Blue Yellow/Amber	DL1BKM1 DL1BKM3 DL1BKM4 DL1BKM6 DL1BKM8	

### Incandescent Bulbs

Description	Voltage	Catalog Number	Price
Bayonet type BA 15d, 7 W	12 Vac/dc 24 Vac/dc 48 Vac/dc 120 Vac/dc 230 Vac/dc	DL1BEJ DL1BEB DL1BEE DL1BEG DL1BEM	\$5.40

### Accessories

Description	Color	Characteristics		Catalog Number	Price
		IN	mm		
Threaded tube with bracket	Silver	4	100	XVPC02T	\$21.70
		10	250	XVPC03T	26.90
		16	400	XVPC04T	32.00
Tube with tulip base	Black	4	100	XVPC02	21.70
		10	250	XVPC03	26.90
		16	400	XVPC04	32.00
	Off-white	4	100	XVPC02W	21.70
		10	250	XVPC03W	26.90
		16	400	XVPC04W	32.00
Wall mounting bracket	Black Off-white	...		XVPC12 XVPC12W	10.40
Bulb mounting and removal tool	...	...		XVPCX13	5.20

### Wiring Diagram

Cable Connections, Supply line maximum: 1.5 mm<sup>2</sup> (#16 AWG)

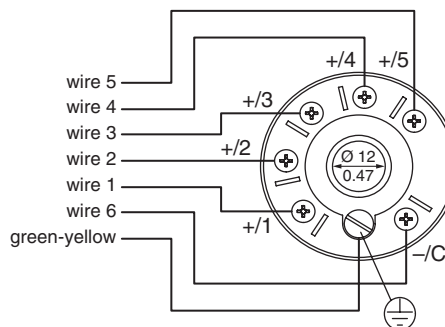

For additional information, reference Catalog #9001CT0001.



The Class 9001 BW70 and BW80 pendant stations are used for hoist applications, requiring either single speed or two speed buttons. The thermoplastic enclosure has a 1/2 inch conduit entrance at top to accept a pendant cable and has internal strain relief provided as standard. The stations are rated NEMA 1, 3, 3R, 4 and 4X. The enclosure is available in three colors. All universal stations have double circuit blocks (1 N.O./1 N.C.) on each button and come without legends so they can be assembled to fit the application. For convenience, push buttons have interchangeable legend inserts. The complete line is UL listed and C.S.A. approved.

No. of Units	Description	Legend Insert Markings	Mechanical Interlock	Enclosure Color			Price	Contact Symbol	Replacement Interior			
				Yellow	Black	Red			9001 Type	Contact Symbol	Price	
2	Single Speed	Up-Down	Yes	BW72Y	BW72B	BW72R	\$84.	146	BOC368	146	\$60.	
		Forward-Reverse	Yes	BW73Y	BW73B	BW73R	84.	146	BOC368	146	60.	
		On-Off ▲	Yes	BW74Y	BW74B	BW74R	113.	10	BOC358	147	60.	
		Start-Stop	No	BW75Y	BW75B	BW75R	84.	145	BOC359	25	60.	
		Start-Stop ▲	Yes	BW76Y	BW76B	BW76R	113.	10	BOC358	147	60.	
		On-Off	No	BW77Y	BW77B	BW77R	84.	146	BOC359	25	60.	
	Two Speed	On-Off	Up-Down	Yes	BW79Y	BW79B	BW79R	84.	145	BOC359	25	60.
			Up-Down	Yes	BW78Y	BW78B	BW78R	84.	100	...	...	...
		without Legend Inserts	without Legend Inserts	Yes	BW70YU	BW70BU	BW70RU	80.	147	BOC366	25	60.
			without Legend Inserts	No	BW71YU	BW71BU	BW71RU	80.	25	BOC359	25	60.
without Legend Inserts	Up-Down	without Legend Inserts	Yes	BW74YU	BW74BU	BW74RU	108.	147	BOC358	147	60.	
		without Legend Inserts	Yes	BW80YU	BW80BU	BW80RU	123.	150	BOC367	150	105.	
			Yes	BW82Y	BW82B	BW82R	128.	150	BOC367	150	105.	

▲ Maintained contact

**Contact Symbol**

**Interchangeable Push Button Legend Inserts**

Marking	For NEMA 4X Type BW70s and BW80s	Mushroom Button Inserts for NEMA 4X Type BW70s and BW80s	Marking	For NEMA 4X Type BW70s and BW80s	Mushroom Button Inserts for NEMA 4X Type BW70s and BW80s	Price Each
	Type	Type		Type	Type	
Start	B259	B282	On Off Hand Auto	B257	B280	\$2.40
Stop	B260	B283		B258	B281	
Forward	B255	B278		B265	B288	
Reverse	B256	B279		B266	B289	
Open	B263	B286				
Close	B264	B287				
Raise	B261	B284	Blank-Black Blank-Red	B251	B251	
Lower	B262	B285		B252	B252	
Up	B253	B276				
Down	B254	B277				

Order must specify quantity of 10 or multiples of 10.

**Legend Insert Kit—Kit includes one each of standard legend inserts as indicated.**

Where Used:	Type	Price
For NEMA 4X Type BW70s and BW80s	Push Button	B250 (Incl's 1 each of B253 thru B266) \$33.30
	Mushroom Button	B300 (Incl's 1 each of B276 thru B289) 33.30

**Hanger Bracket**

Form	Price
Y236	\$7.00

Addition of External hanger bracket (similar to the one used on Class 9001 Type SKYP Pendant Stations). Use when polymeric cord connectors are required.

For Dimensions ..... Catalog 9001CT0001

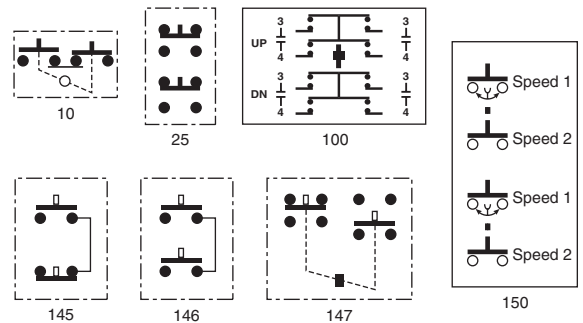

**Replacement Enclosures**

Description	Yellow	Price	Red	Price	Black	Price
Box & Cover with 4 screws	BWRY	\$36.	BWRR	\$36.	BWRB	\$36.

**Mushroom Button (less button insert)—For NEMA 4X, Type BW70 and BW80**

Color	Type	Price
Red	B303	\$9.50

**Hanger Bracket and Seal Kit**

Type	Price
B350	\$4.80

**Electrical Contact Ratings (BW70s and BW80s)**

Volts ■	AC—NEMA B600					Continuous Carrying Amperes	Resistive 75% Power Factor	Volts	DC—NEMA P600)	
	Inductive 35% Power Factor		Resistive 75% Power Factor		Inductive and Resistive					
	Make	Break	Make and Break	Continuous Carrying Amperes						
	Amperes	VA	Amperes	VA	Amperes	Amperes	Volts	Amperes	Amperes	
120	30.	3600	3.	360	5	5	120	1.1	5	
240	15.	3600	1.5	360	5	5	240	.55	5	
480	7.5	3600	.75	360	5	5	600	.2	5	
600	.6	3600	.6	360	5	5			5	

■ OSHA Regulation, Section 1910.70 Overhead and Gantry Cranes, limits the voltage at Pendant Push Buttons to 150 Vac or 300 Vdc.

For additional information, reference Catalog #9001CT0001.

# Pendant Stations, XAC Standard Duty

## Pistol Grips, Enclosures, Contact Blocks

**SQUARE D**  
www.SquareD.com  
For the most up-to-date information

17 PUSH BUTTONS AND OPERATOR INTERFACE



XACA06



XACA03



ZB2BE10•



XENG37•1

### Specifications

Electrical ratings	NEMA A600, Q600		
Enclosure	XACAO•	NEMA 4, 4X (Indoor/Outdoor), 5 IP65	
	XACA2O• (Pistol grip)	NEMA 4, 4X (Indoor), 5 IP65	
Cabling	Screw and captive clamp terminals. Recommended torque 15.62 in-lb. Capacity: minimum 1 x 5 mm <sup>2</sup> (20 AWG) solid or stranded, maximum with or without cable end: 2 x 1.5 mm <sup>2</sup> (16 AWG) or 1 x 2.5 mm <sup>2</sup> (14 AWG) or by cable clips conforming to NF C 20-120 (on request).		
Approvals	For XACA	File E 164353 CCN NKCR	File LR 44087 Class 3211 03
		Marked	

### Pistol Grip Stations

Description	Speeds	Function 1 speed/2 speed	Catalog Number	Price
1 N.O. contact per operator 2 Mechanically interlocked operators	1	↑ ↓	XACA201▲	\$68.
2 N.O. (staggered) contacts per operator 2 Mechanically interlocked operators	2	↕	XACA207▲	101.
1 N.O. + 1 N.C. 2 Mechanically interlocked operators	1	↑ ↓	XACA205▲	85.
1 N.O. contact per direction 1 Mechanically interlocked 2 way toggle	1	↑ ↓	XACD21A0101■	76.
1 N.O. + 1 N.O. staggered 1 Mechanically interlocked 2 way toggle	2	↕	XACD21A1231■	205.
1 N.O. & 1 N.C. contact per direction 1 Mechanically interlocked 2 way toggle	1	↑ ↓	XACD21A0105■	92.
1 N.C. + 1 N.O. + 1 N.O. staggered 1 Mechanically interlocked 2 way toggle	2	↕	XACD21A1241■	218.

▲ These units are available with factory installed E-stops. Add a "3" to the end of the catalog number for standard E-stop or add a "4" for a trigger action E-stop. Consult your local Square D sales office for price adder.

■ These units are available with a factory installed E-stop. Use XACD22\*\*\* for a standard E-stop or XACD24\*\*\* for a trigger action E-stop.

### General Purpose Pendants♦

Enclosures	Catalog Number	Price
2 hole enclosure	XACA02	\$96.
3 hole enclosure	XACA03	110.
4 hole enclosure	XACA04	125.
6 hole enclosure	XACA06	153.
8 hole enclosure	XACA08	191.
12 hole enclosure	XACA12	239.

♦ Standard enclosures include internal mounting plate, cable sleeve for 8 to 26 mm, internal cable clamp, suspension ring and cable tie.

UV PROTECTED  
FOR OUTDOOR USE

For additional information, reference Catalog #9001CT0001.

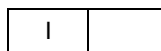

**Contact Blocks for Operators in Cover**

Description	Wiring Diagram	Catalog Number	Price
1 N.O./spring return/1 speed	...	ZB2BE101	\$8.20
1 N.C./spring return/1 speed	...	ZB2BE102	8.20
1 N.O. early close & 1 N.C. & 1 N.O./spring return/2 speed	Figure 1	XENG1191	24.50
1 N.C. & 2 N.O./spring return/1 speed	Figure 2	XENG1491	24.50
1 N.O. & 1 N.O. latching/1 speed/interlocked	Figure 3	XENG3781	24.50
1 N.O. & 1 N.C. latching/1 speed/interlocked	Figure 4	XENG3791	24.50



ZB2BE10●



XENG3781●



XENG1191



XACS10●

**For Operators in Base of Enclosure ▲**

1 N.O./1 speed	XACS101	\$14.30
1 N.C./1 speed	XACS102	14.30
2 N.O./1 speed	XACS103	19.10
2 N.C./1 speed	XACS104	19.10
1 N.O. & 1 N.C./1 speed	XACS105	19.10

▲ Cannot be used with XACA03 pendant.

**Wiring Diagrams**



Figure 1

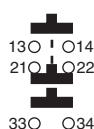

Figure 2



Figure 3



Figure 4

**Operators ■**

Description	Color	Catalog Number	Price
Booted push button	White	XACA9411	\$4.10
	Black	XACA9412	
	Green	XACA9413	
	Red	XACA9414	
	Yellow	XACA9415	
	Blue	XACA9416	
	Brown	XACA9419	

Description	Mushroom Size	Color	Catalog Number	Price
Mushroom head, momentary	30 mm	Black	ZA2BC24	\$18.40
		Red	ZA2BC44	
Mushroom head, momentary	40 mm	Black	ZA2BC2	18.40
		Red	ZA2BC4	
Mushroom head, push to maintain/turn-to-release	30 mm	Red	ZA2BS44	39.30
	40 mm	Red	ZA2BS54	39.30
Mushroom head, push to maintain/turn-to-release (trigger action) ◆	30 mm	Red	ZA2BS834	56.00
	40 mm	Red	ZA2BS844	56.00
Mushroom head, push to maintain/key turn-to-release	30 mm	Red	ZA2BS74	56.00
	40 mm	Red	ZA2BS14	56.00
Mushroom head, push to maintain/key turn-to-release (trigger action) ◆	40 mm	Red	ZA2BS944	56.00

Description	Color	Catalog Number	Price
Selector switch/2 position—maintained★	Black	ZA2BD2	\$15.00
Selector switch/3 position—maintained★	Black	ZA2BD3	15.00
Selector switch/2 position—maintained key operated—key removal from LT or RT position★	NA	ZA2BG4	56.00
Selector switch/3 position—maintained key operated—key removal from LT or RT position★	NA	ZA2BG5	56.00
Wobble stick (bottom mounting recommended)	Black	ZA2BB2	51.00
	Red	ZA2BB4	

**Pilot light components**

Description	Color	Catalog Number	Price
Direct supply base/without lamp (for 6 to 120 V applications) (AC/DC)	...	ZB2BV006	\$12.30
Resistor supply base/with 130 V lamp (for 220–240 V applications) (AC/DC)	...	ZB2BV007	26.00
Pilot light operators for incandescent lamps	Green	ZA2BV03	4.80
	Red	ZA2BV04	
	Amber	ZA2BV05	
	Blue	ZA2BV06	
	Clear	ZA2BV07	
Pilot light operators for LED lamps	Green	ZA2BV033	4.80
	Red	ZA2BV043	
	Amber	ZA2BV053	

■ Booted push buttons are for cover mounting only. All other operators can be mounted on cover or bottom.  
◆ Trigger action mushroom heads are tamper proof in that a change of contact state is not possible by teasing or floating the operator.  
★ Not for use with XEN G contact blocks.

For additional information, reference Catalog #9001CT0001.



Booted Push Button



Mushroom Head



Selector Switch



Selector Switch (key operated)



Wobble Stick

# Pendant Stations, XAC Standard Duty Operators

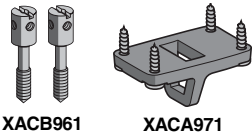

XACB961

XACA971

## Enclosure Accessories

Description	Catalog Number	Price
Blank hole plug	ZB2SZ3	\$6.80
Mechanical interlock (momentary). For use with XAC booted operators only	XACA009	4.10
Screw adapter for self-supporting cable	XACB961	3.40
Low suspension ring for single row station	XACA971	9.60
Protective guard for bottom mounted mushroom head	XACA982	9.60
Protective guard for bottom mounted selector switch or key switch	XACA983	13.70

## Lamps

Type	Voltage	Watts	Catalog Number	Price
Replacement bulbs (Type BA9s) Incandescent	6 Vac/dc	1.2	DL1CB006	\$5.50
	12 Vac/dc	2.0	DL1CE012	
	24 Vac/dc	2.0	DL1CE024	
	48 Vac/dc	2.4	DL1CE048	
	130 Vac/dc	2.6	DL1CE130	
Neon (use with direct supply light module)	120 Vac/dc	...	NE51HRT120V	7.60
	220 Vac/dc	...	NE51HRT220V	
	380 Vac/dc	...	NE51HRT380V	

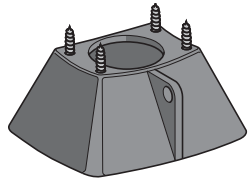

XACA982

Type	Color	Voltage	Catalog Number	Price
LED, BA9s base for Direct Supply blocks	Green	6 Vac/dc	DL1CJUS0063	\$12.50
	Red	6 Vac/dc	DL1CJUS0064	
	Amber	6 Vac/dc	DL1CJUS0065	
	Green	12 Vac/dc	DL1CJUS0123	
	Red	12 Vac/dc	DL1CJUS0124	
	Amber	12 Vac/dc	DL1CJUS0125	
	Green	24 Vac/dc	DL1CJUS0243	
	Red	24 Vac/dc	DL1CJUS0244	
	Amber	24 Vac/dc	DL1CJUS0245	
	Green	120 Vac/dc	DL1CJUS1203	
	Red	120 Vac/dc	DL1CJUS1204	
	Amber	120 Vac/dc	DL1CJUS1205	

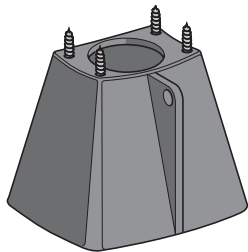

XACA983

## PVC Standard Legend Plates 30 x 40 mm

Text▲	Catalog Number	Price	Text▲	Catalog Number	Price
Bridge Forward	ZB2BY2343	\$2.10	Off	ZB2BY2312	\$2.10
Bridge Reverse	ZB2BY2344		On	ZB2BY2311	
Close	ZB2BY2314		Off On	ZB2BY2367	
Down	ZB2BY2308		Open	ZB2BY2313	
Emergency Stop	ZB2BY2330		Open Close	ZB2BY2376	
Fast	ZB2BY2328		Open-O-Close	ZB2BY2388	
Forward	ZB2BY2305		Out	ZB2BY2339	
For Rev	ZB2BY23		Power On	ZB2BY2326	
For-O-Rev	ZB2BY2384		Raise	ZB2BY2335	
Hand Off Auto	ZB2BY2387		Reset▲	ZB2BY2323	
High	ZB2BY2338		Reverse	ZB2BY2306	
High Low	ZB2BY2369		Right	ZB2BY2309	
Hoist Down	ZB2BY2342		Run	ZB2BY2334	
Hoist Up	ZB2BY2341		Slow	ZB2BY2327	
In	ZB2BY2503		Start	ZB2BY2303	
Inch	ZB2BY2321		Stop	ZB2BY2304	
Jog For	ZB2BY2381		Stop Start	ZB2BY2366	
Jog Rev	ZB2BY2380		Trolley Right	ZB2BY2345	
Jog Run	ZB2BY2365		Trolley Left	ZB2BY2346	
Left	ZB2BY2310		Up	ZB2BY2307	
Low	ZB2BY2336		Up Down	ZB2BY2370	
Lower	ZB2BY2337		Up-O-Down	ZB2BY2389	
Man Auto	ZB2BY2372				

▲ All nameplates are black with white lettering except "Stop", "Emergency Stop" and "Reset" which are red with white lettering. For black "Reset" change final digit of catalog number to 2.

Type	Description	Catalog Number	Price
PVC blank legend	Blank	Black or red background—30 mm x 40 mm	ZB2BY2101
	Blank	Yellow or white background—30 mm x 40 mm	ZB2BY4101
PVC custom engraved	Special engraving■	Black background, white letters—30 mm x 40 mm	ZB2BY2002
	Special engraving■	Red background, white letters—30 mm x 40 mm	ZB2BY2004
	Special engraving■	White background, black letters—30 mm x 40 mm	ZB2BY4001
	Special engraving■	Yellow background, black letters—30 mm x 40 mm	ZB2BY4005

■ Please specify lettering when ordering. Two lines with 11 characters (including spaces) maximum on each line.

For additional information, reference Catalog #9001CT0001.

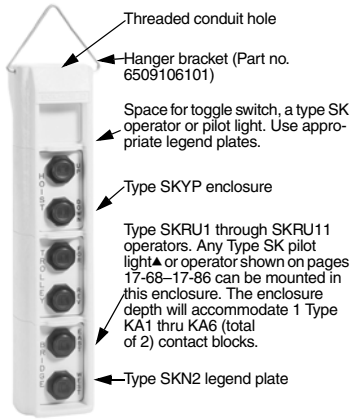

**Multispeed Contact Symbols**  
("X" = Contact Closed)

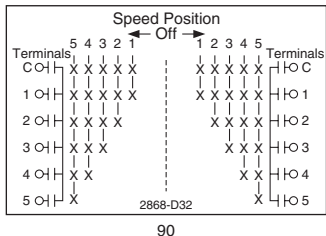
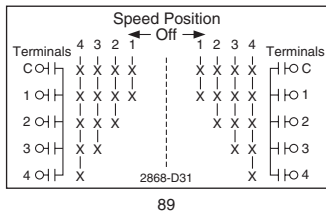
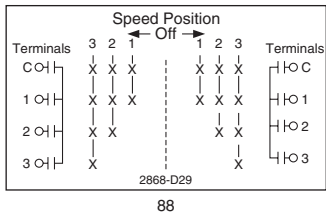
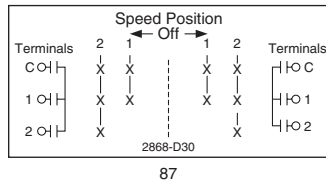

**Enclosures**

Size	Conduit Entrance Size	Enclosure Only ■	Enclosure For Assembled Station ▲	Price
		Type	Type	
2 Button	3/4"-14NPT	SKYP2	SKYP20	\$126.
4 Button	3/4"-14 NPT	SKYP4	SKYP40	159.
6 Button	1"-11 1/2 NPT	SKYP6	SKYP60	191.
8 Button	1 1/4"-11 1/2 NPT	SKYP8	SKYP80	237.
10 Button	1 1/4"-11 1/2 NPT	SKYP10	SKYP100	285.

▲ Class 9001 SK push-to-test pilot lights, remote test pilot lights and potentiometers will not fit in these enclosures.  
■ Assembled pendant stations consist of an enclosure, operators and legend plates. The price of the total station consists of the prices of the individual components - there is no charge for assembly. **Example: 9001 SKYP20 plus 9001 SKRU5 plus 9001 SKN201; total price is \$368.70.** All custom orders must include pendant key sheet available from Square D sales offices or distributors.

**Push Button Units★**

Number of Buttons Per Unit	Description	Contact Symbol—See Below	Type ♦	Price
2	Single Speed—Momentary Interlocked	7	SKRU1	\$86.
2	Single Speed—Momentary Non-Interlocked	5	SKRU10	71.
2	Single Speed—Maintained Interlock	10	SKRU11	99.
2	Two Speed—Momentary Interlocked	87	SKRU2	180.
2	Three Speed—Momentary Interlocked	88	SKRU3	213.
2	Four Speed—Momentary Interlocked	89	SKRU4	227.
2	Five Speed—Momentary Interlocked	90	SKRU5	237.

♦ Types SKRU 1, 10 and 11 use Type KA contact blocks. Types SKRU 2 thru 5 are factory enclosed contact blocks.  
★ For ring nuts see 17-86.

**Legend Plates**

	Where Used	Marking	Type	Price
	For SKRU1 through SKRU11	Blank-Blank Hoist: Up-Down Trolley: East-West Trolley: Fwd.-Rev. Trolley: North-South Bridge: Fwd.-Rev. Bridge: East-West Bridge: North-South Start-Stop Reset-Stop Aux Hoist: Up-Down Power: On-Off Specify Marking	SKN200★ SKN201 SKN202 SKN203 SKN204 SKN205 SKN206 SKN207 SKN208 SKN209 SKN210 SKN211 SKN299	\$5.70 5.70 5.70 5.70 5.70 5.70 5.70 5.70 5.70 5.70 5.70 5.70 24.80
	With Toggle Switch ▼ in Top Space of Enclosure	Blank Off-On On-Off Specify Marking	SKN500□ SKN544□ SKN545□ SKN599□	8.60 8.60 8.60 18.00
	With Type SK Operator or Pilot Light ▲ in Top Space of Enclosure	Blank On Off Emerg. Stop Run Power On Off-On Specify Marking	SKN100♦ SKN103 SKN104 SKN105 SKN124 SKN138 SKN144 SKN199♦	2.90 2.90 2.90 2.90 2.90 2.90 2.90 12.30

▼ Can be supplied by Square D as Class 9001 Type SKSTS1 at \$35.60—includes boot for NEMA 4X rating.  
▲ See Class 9001 Type SK, pages 17-68-17-86.  
□ Includes legend plate, gasket and ground plate to be used with toggle switch.  
♦ Tri-laminated legend plate having a yellow or red background on a black core.  
★ 19 characters each side max.

**Closing Plate**

	Type	Price
	SK52	\$9.50

**Single Speed Contact Symbols**

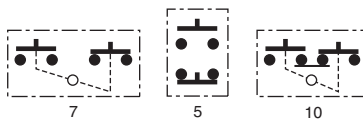

File E42259  
CCN NKCR



File LR25490  
Class 321103



Marked

For additional information, reference Catalog # 9001CT0001.

# Foot Switches

Type A  
Class 9002

## Heavy Duty Industrial Foot Switches—Oiltight, Watertight, Dusttight and Driptight Enclosure, NEMA 2, 4 and 13



**DANGER**

---

**HAZARDOUS APPLICATIONS**

Do not use foot switches on machines without point-of-operation protection.

**Failure to follow this precaution will result in serious injury.**

### Foot Switch Selection

Foot switches are used to control many industrial processes, while leaving the operator's hands free to perform other functions. The type or model of foot switch suitable for each application will vary depending on factors such as the control function required, degree of protection required, production methods, unusual conditions, government regulations, etc. In some applications more than one foot switch may be required, as when two or more persons are operating a machine. In these cases, safe practice and regulations require that the foot switches be wired in series making it necessary that each operator's foot switch be actuated before the machine will cycle.

Only the user can be aware of all the conditions and factors present during setup, operation and maintenance of the machine; therefore, only the user can determine which foot switch(es) can be properly used. When selecting a foot switch for a particular application, the user should refer to the applicable ANSI standards and OSHA regulations. The National Safety Council's Accident Prevention Manual also provides much useful information.

In some applications, such as power presses, additional operator protection such as point-of-operation guarding must be provided when a foot switch is used as an actuator. This is necessary since the operator's hands and other parts of the body are free to enter the pinch point area and serious injury can occur. The shielding provided on foot switches cannot protect an operator from injury. For this reason the foot switch cannot be substituted for or take the place of point-of-operation protection.

A Trilingual Danger Sign regarding the need for point-of-operation protection is supplied with each foot switch. The sign incorporates three languages: English, Spanish and French. Additional copies of the sign are available by contacting your Square D sales office.

**Type AW Fully Shielded Foot Switch with Oversized Pedal Shield, Side Shields and Safety Door.** The Safety Door is interlocked with the pedal to prevent operation due to shock or vibration. It prevents accidental pedal operation by requiring a simple but intentional motion to lift the door before inserting the foot.



**Type AW Foot Switch with Top Pedal Shield and Side Shields**



**Type AW with Oversized Pedal Shield and Side Shields**



**Type AW Foot Switch without Pedal Shield**

Description	Features	Fully Shielded with Oversized Pedal Shield, Side Shields and Safety Door		With Oversized Pedal Shield and Side Shields		With Pedal Shield and Side Shields		UNSHIELDED (See warning note▼)	
		Type	Price	Type	Price	Type	Price	Type	Price
Single Pole ■ Double Throw	Spring Return With Mechanical Latch	AW117 ...	\$500. ...	AW132 ...	\$500. ...	AW2 AW7	\$242. 351.	AW1 ...	\$264. ...
Two Pole ■ Double Throw	Spring Return With Mechanical Latch	AW124▲ ...	602. ...	AW133 ...	602. ...	AW14 AW15	351. 461.	AW13 ...	383. ...
Two Stage ■ (One Pole Each Stage) Table 1	Spring Return With Mechanical Latch in 1st Stage With Mechanical Latch in 2nd Stage	AW119 ...	620. ...	AW134 ...	620. ...	AW6 AW9 AW10	362. 470. 470.	AW5 ...	393. ...
Four Stage ■ (One Pole Each Stage) Table 2	Spring Return	AW123	863.	...	...	AW22	608.	AW21	663.
Single Pole Single Throw	Maintained Contact—Push On/Push Off	...	...	...	...	AW12	352.	AW11	383.
Replacement Cover Assembly	...	AC5	242.	AC7	242.	AC8★	93.	AC1	102.

### Replacement Parts:

For Class 9002 Type AW:  
See Bulletin  
No. 65013-010-31

- ▲ 2 N.O. and 2 N.C. isolated, direct acting contacts.
- A single pole snap switch that contains two double break contact elements (1 N.O. and 1 N.C.) must be used on circuits of same polarity.
- ▲ A double pole snap switch contains two electrically separated sets of contact elements allowing use on circuits of opposite polarity. Each set that contains two double break contact elements (1 N.O. and 1 N.C.) must be used on circuits of same polarity.
- ◆ In NEMA 1, General Purpose Enclosure. See Table 3 on page 17-121 for contact symbol.
- ★ For replacement cover drilled to accept latch. For Series C foot switches order AC9. Price is \$182. No replacement cover available for Series A or B devices drilled to accept latch.
- ▼ **WARNING:** These foot switches must not be used to operate machines or equipment where the possibility of operator injury exists. Typical uses include Emergency Stop functions, "Dead Man" controls, signal functions (lights, bells, etc.).



File E42259  
CCN NKCR



File LR25490  
Class 184 N 13.1U



**Approximate Dimensions**

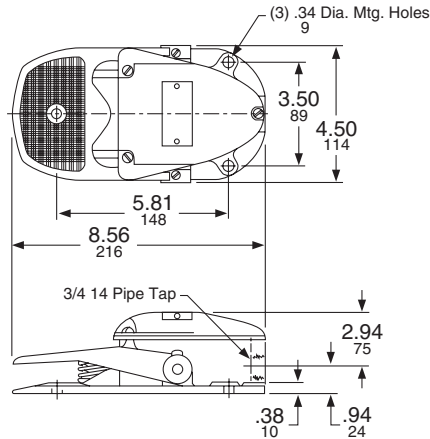

**Types AW1, AW5, AW11, AW13 and AW21**

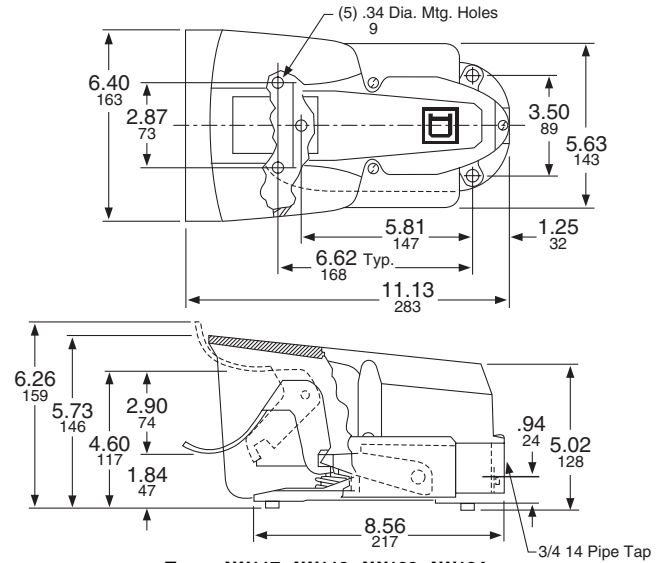

**Types AW117, AW119, AW123, AW124**  
**Types AW132, AW133 and AW134 (without safety door)**

Dual Dimensions: **INCHES**  
Millimeters

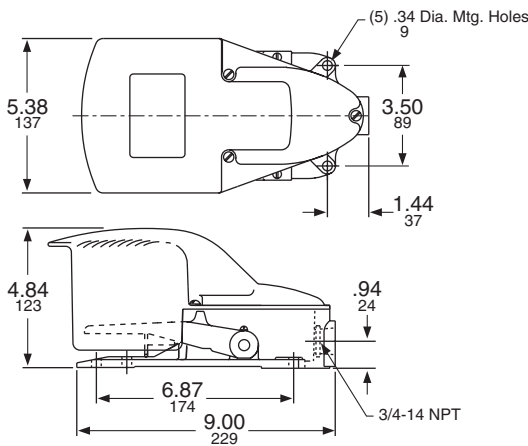

**Types AW2, AW6, AW12, AW14 and AW22**

**Maximum Current Ratings For Control Circuit Contacts**

Type	Volts	AC Amperes			Volts	DC Amperes		
		Inductive 35% Power Factor		Resistive 75% Power Factor		Inductive and Resistive		
		Make	Break			Make, Break and Continuous	Make and Break	
				Single Throw			Double Throw	
AW1 through AW10, AW117, AW119, AW132	120	40	15	15	125	2.0	0.5	15
	240	20	10	10	250	0.5	0.2	15
	480	10	6	6	600	0.1	0.02	15
AW13, AW14, AW15, AW133	120	30	3	3	125	1.0	0.2	10
	240	15	1.5	1.5	250	0.3	0.1	10
	480	7.5	0.75	0.75	600	0.1	...	10
AW11, AW12	115	36	6	...	125	2.2	...	...
	230	18	3	...	250	1.1	...	...
	...	...	...	...	...	...	...	...
AW21, AW22, AW123	120	15.0	1.5	10	...	...	...	...
	240	7.5	0.75	10	...	...	...	...
	480	3.75	0.375	10	...	...	...	...
AW124	120	60	6	10	120	1.1	...	10
	240	30	3	10	240	0.55	...	10
	480	15	1.5	10	600	0.2	...	10

**Note:** Double throw switches are rated 250 Vdc maximum.

**TABLE 1**  
**Contact Symbol—Two Stage**

Snap Switch		Pedal		
Unit	Circuit	Up	Half Down	Full Down
1	A1	0	1	1
	B1	1	0	0
2	A2	1	1	0
	B2	0	0	1

0 = Open 1 = Closed

**TABLE 2**  
**Contact Symbol—Four Stage**

Snap Switch		Pedal Position			
Unit	Circuit	Up → Down			
1	1A1	0	0	1	1
	1B1	1	1	0	0
	2A1	0	1	1	1
	2B1	1	0	0	0
2	1A2	1	1	1	0
	1B2	0	0	0	1
	2A2	1	1	1	1
	2B2	0	0	0	1

## Rotary Cam Switches

K10 Miniature, K2 Custom, K30–K150 Power Switching

### A New Extended Offer, Three Ranges: Your Solution



#### K10 Miniature

- NEMA, A300, 300 V, 10 A
- Stepping, reversing, changeover
- 16 mm or 22 mm mounting
- 30 x 30 mm front plate
- Complete with handle and legend



#### K2 Custom Cam Switches

- NEMA, A300, 300 V, 10 A
- Stepping, reversing, changeover
- Mounting by 22 mm or 4 holes
- Fast delivery of custom switches
- XB4 style handle available



#### K30–K150 Power Switching

- 32 to 150 A (40 hp @ 480 V)
- Starting, reversing
- Mounting 48 x 48 or 64 x 64 mm
- Front plates 64 x 64 or 88 x 88 mm
- Fast delivery from global stock
- Complete with handle and legend

For more information, reference Catalog #9001CT0001.