

# Axial Flow Fans

AC

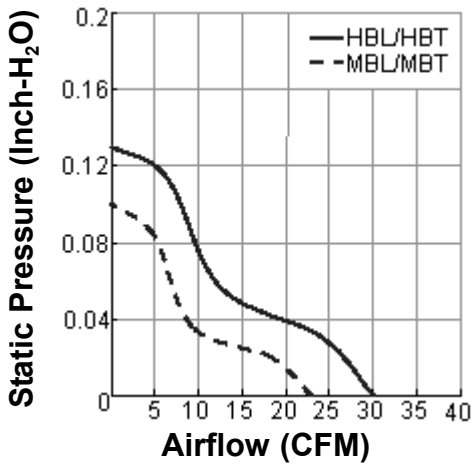

Ball (50Hz)



Ball (60Hz)

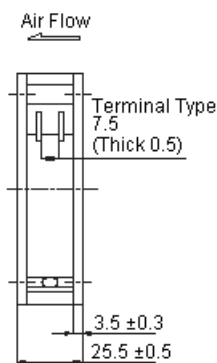
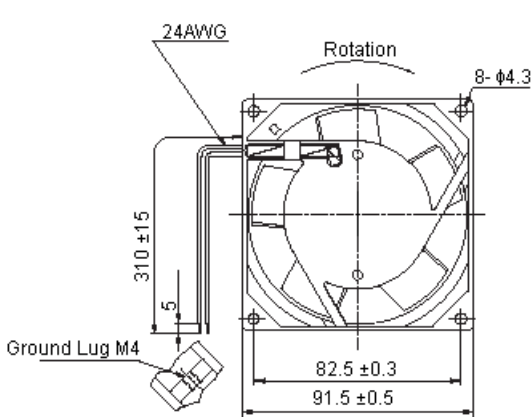
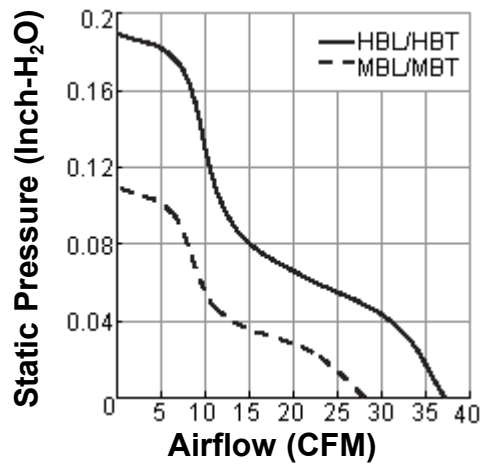

Dimensions : Millimetres

Inlet

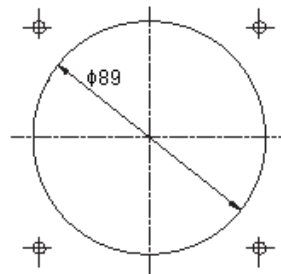

Outlet

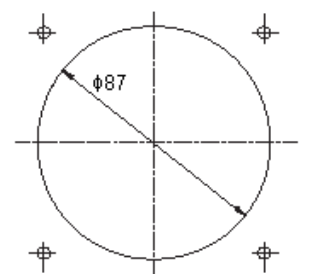

# Axial Flow Fans



## AC

### Specifications

**Frame** : Aluminum alloy.  
**Bearing** : Ball.  
**Size** : 92 x 92 x 25mm.

### Specification Table

Voltage Rating (V ac)	Frequency (Hz)	Power Current (A)	Power Consumption (W)	Speed (RPM)	Air Flow (CFM)	Static Pressure (Inch-H <sub>2</sub> O)	Noise (dBA)	Weight (g)	Part Number
115	50/60	0.70/0.06	7/6	1800/2100	23/28	0.10/0.11	31/33	280	MCSF11592A 1092MBL.GN
220 to 240	50/60	0.07/0.07	15/14	2200/2700	28/35	0.12/0.18	35/38	280	MCSF23092A 2092MBL.GN

### Part Number Explanation:

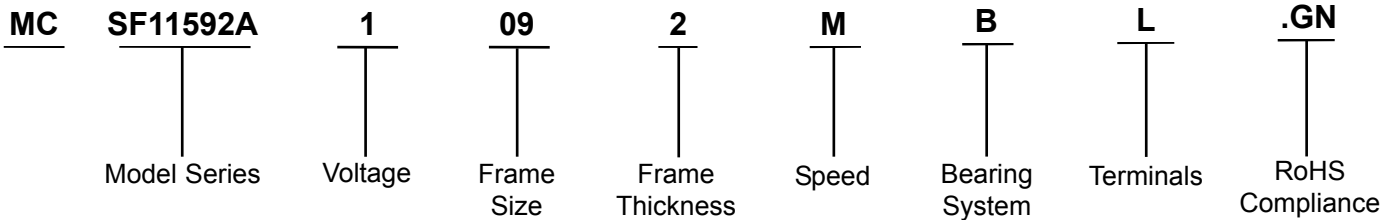

**Model Series** : MCSF11592A and MCSF23092A.  
**Voltage** : 1 = 115V ac and 2 = 220 to 240V ac.  
**Frame Size** : 09 = 92mm.  
**Frame Thickness** : 2 = 25mm.  
**Speed** : M = Middle.  
**Bearing System** : B = Ball.  
**Terminals** : L = Lead Wire.



# Axial Flow Fans

## AC



### Notes:

### International Sales Offices:

 <b>AUSTRALIA - Farnell</b> Tel No: ++61 1300 361 005 Fax No: ++61 1300 361 225	 <b>FINLAND - Farnell</b> Tel No: ++ 358 9 560 7780 Fax No: ++ 358 9 345 5411	 <b>ITALY - Farnell</b> Tel No: ++ 39 02 93 995 200 Fax No: ++ 39 02 93 995 300	 <b>SPAIN - Farnell</b> Tel No: 901 20 20 80 Fax No: 901 20 20 90
 <b>AUSTRIA - Farnell</b> Tel No: ++ 43 662 2180 680 Fax No: ++ 43 662 2180 670	 <b>FRANCE - Farnell</b> Tel No: ++ 33 474 68 99 99 Fax No: ++ 33 474 68 99 90	 <b>MALAYSIA - Farnell-Newark</b> Tel No: ++ 60 3 7873 8000 Fax No: ++ 60 3 7873 7000	 <b>SWEDEN - Farnell</b> Tel No: ++ 46 8 730 50 00 Fax No: ++ 46 8 83 52 62
 <b>BELGIUM - Farnell</b> Tel No: ++ 32 3 475 2810 Fax No: ++ 32 3 227 3648	 <b>GERMANY - Farnell</b> Tel No: ++ 49 89 61 39 39 39 Fax No: ++ 49 89 613 59 01	 <b>NETHERLANDS - Farnell</b> Tel No: ++ 31 30 241 7373 Fax No: ++ 31 30 241 7333	 <b>SWITZERLAND - Farnell</b> Tel No: ++ 44 204 64 64 Fax No: ++ 44 204 64 54
 <b>BRAZIL - Farnell-Newark</b> Tel No: ++ 55 11 4066 9400 Fax No: ++ 55 11 4066 9410	 <b>HONG KONG - Farnell-Newark</b> Tel No: ++ 852 2268 9888 Fax No: ++ 852 2268 9899	 <b>NEW ZEALAND - Farnell</b> Tel No: 0800 90 80 80 Fax No: 0800 90 80 81	 <b>UK - Farnell</b> Tel No: ++ 44 8701 200 200 Fax No: ++ 44 8701 200 201
 <b>CHINA - Farnell-Newark</b> Tel No: ++86 10 6238 5152 Fax No: ++86 10 6238 5022	 <b>HUNGARY - Farnell</b> Tel No: ++ 44 870 1200 208 Fax No: ++ 44 870 1200 209	 <b>NORWAY - Farnell</b> Tel No: 800 146 70 Fax No: 800 146 76	 <b>UK - CPC</b> ++ 44 8701 202 530 ++ 44 8701 202 531
 <b>CZECH REPUBLIC - Farnell</b> Tel No: ++ 44 870 1200 208 Fax No: ++ 44 870 1200 209	 <b>INDIA - Farnell</b> Tel No: ++ 44 870 1200 208 Fax No: ++ 44 870 1200 209	 <b>PORTUGAL - Farnell</b> Tel No: ++ 34 93 475 8804 Fax No: ++ 34 93 474 5288	 <b>USA - Newark</b> Tel No: 800 463 9275
 <b>DENMARK - Farnell</b> Tel No: ++ 45 44 53 66 44 Fax No: ++ 45 44 53 66 06	 <b>IRELAND - Farnell</b> Tel No: ++ 353 1 830 9277 Fax No: ++ 353 1 830 9016	 <b>RUSSIA - Farnell</b> Tel No: ++ 44 870 1200 208 Fax No: ++ 44 870 1200 209	 <b>EXPORT - Farnell</b> Tel No: ++ 44 8701 200 208 Fax No: ++ 44 8701 200 209 <b>For enquiries from all other markets</b>
 <b>ESTONIA - Farnell</b> Tel No: ++ 358 9 560 7780 Fax No: ++ 358 9 345 5411	 <b>ISRAEL - Farnell</b> Tel No: ++ 180 937 0015 Fax No: ++ 180 937 0014	 <b>SINGAPORE - Farnell-Newark</b> Tel No: ++ 65 6788 0200 Fax No: ++ 65 6788 0300	<a href="http://www.farnell.com">http://www.farnell.com</a> <a href="http://www.newark.com">http://www.newark.com</a> <a href="http://www.cpc.co.uk">http://www.cpc.co.uk</a>

**Disclaimer** This data sheet and its contents (the "Information") belong to the Premier Farnell Group (the "Group") or are licensed to it. No licence is granted for the use of it other than for information purposes in connection with the products to which it relates. No licence of any intellectual property rights is granted. The Information is subject to change without notice and replaces all data sheets previously supplied. The Information supplied is believed to be accurate but the Group assumes no responsibility for its accuracy or completeness, any error in or omission from it or for any use made of it. Users of this data sheet should check for themselves the Information and the suitability of the products for their purpose and not make any assumptions based on information included or omitted. Liability for loss or damage resulting from any reliance on the Information or use of it (including liability resulting from negligence or where the Group was aware of the possibility of such loss or damage arising) is excluded. This will not operate to limit or restrict the Group's liability for death or personal injury resulting from its negligence. SPC Multicomp is the registered trademark of the Group. © Premier Farnell plc 2008.

