

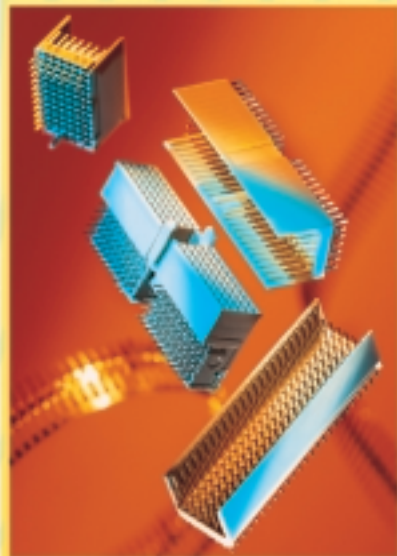

***har:bus*® HM**

Hard metric connectors  
according to IEC 61076-4-101



Certified according to DIN EN ISO 9001  
in design/development, production,  
installation and servicing

## Quality Connections Worldwide

HARTING was founded in 1945 by the family that still owns the company.

Today, HARTING employs around 2200 people worldwide, including 150 qualified engineers. The sales team, including more than 100 sales engineers is in daily contact with our customers.

The company is one of the world's leading manufacturers of connectors, and currently have 31 subsidiary companies in Europe, the United States and Asia. In several product areas, HARTING is a market leader.

Great emphasis is placed on close links with customers, including the provision of a 'Just-in-Time'-Service to ensure rapid delivery to key customers.

HARTING products are designed and manufactured using the latest automated techniques, from CAD systems in the research and development department to automatic production techniques on the assembly lines.

Production and quality control is based on a 'zero-error' philosophy which can only be reached by the continuous successful implementation of fully automated production techniques. The organisation and procedures for quality assurance are based on the EN ISO 9001 standard. A total of 60 engineers and other employees, most of whom are trained and qualified to standards laid down by the DGQ (German Association of Quality) or the SAQ (Swiss Association of Quality), are employed solely on quality-assurance activities.

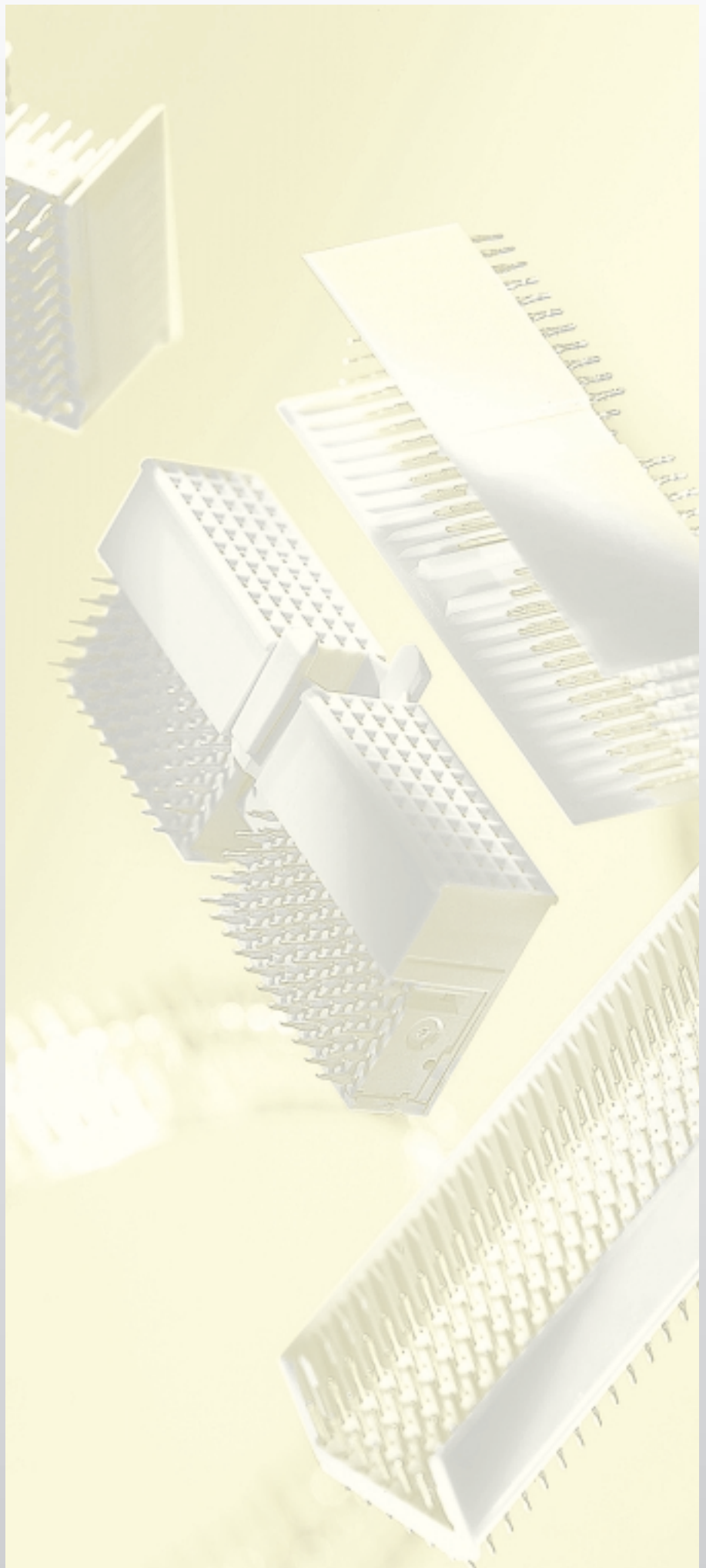

## Summary

Page

Introduction

4

Comparison of different 2 mm systems

5

Technical characteristics

6

Contacts for male connectors

6

Press-in technique

7

Typical configurations on PCB

8

Type A – male connectors

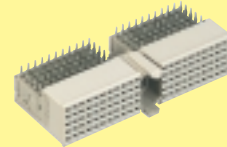
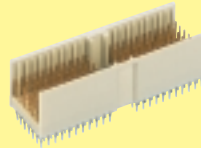

9

Type A – female connectors

12

Type B – male connectors

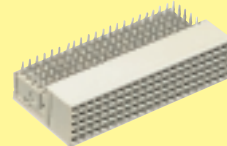
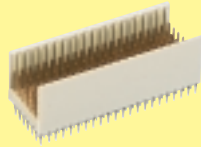

13

Type B – female connectors

17

Type C – male connectors

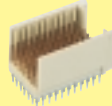

18

Type C – female connectors

20

Type D – male connectors

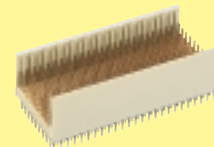
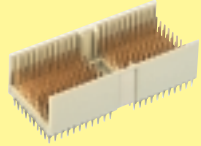

21

Type E – male connectors

22

CompactPCI configuration

23

CompactPCI monoblock – male connectors

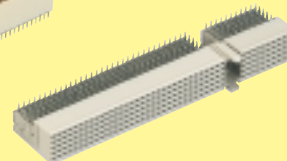
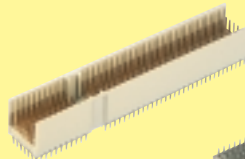

25

CompactPCI monoblock – female connectors

27

Coding

28

VME64x configuration

29

VME64x – male connectors

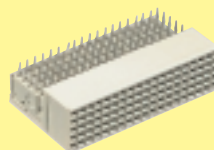
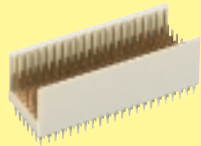

30

VME64x – female connectors

31

Tooling

32

Customer request form

33

List of part numbers

34

Addresses

35

## harbus<sup>®</sup> HM the 2.0mm hard metric system from HARTING

### Introduction

A continual trend has seen the move towards the miniaturisation of electronic components and the advances in processing speeds and data transmission rates. This results into faster being routed through connectors between PCB's, I/O Panels, transition boards or cables. The need for higher pin counts has resulted in a shift from 2.54 mm and 2.5 mm pitch connectors to 2.0 mm variants.

The industrial market utilising standard components is dominated by the VMEbus where 50% market share is achieved and projected to grow at an annual rate of 10%. CompactPCI<sup>®</sup> systems are projected to grow at rates in excess of 100% to approach a market size similar to VMEbus.

The expected growth rate for CompactPCI<sup>®</sup> is realised as a result of the PC/PCI domination in the desktop/office market. Many industrial hardware and software applications can be processed such as Windows NT and graphical user interface etc. CompactPCI<sup>®</sup> benefits from the available software, expert knowledge, commodity chips and the general infrastructure in the PCI desktop market.

The Telecoms market is evolving to include standard bus-board equipment, which allows manufacturers to concentrate on proprietary systems where traditionally a minimal number of corporations with world-wide activities participated. These markets have been deregulated which has dramatically increased the rate of change in technology. It is no longer profitable to manufacture all the elements of a system under one roof and maintain a short time to

market. Corporations had started to use desktop computers for a short period, but applications required guaranteed availability for many years using standard pin and socket connectors with mechanically secured boards. Therefore CompactPCI<sup>®</sup> provided the benefits of a desktop PC, a short time to market, rugged reliability and a popular software development platform.

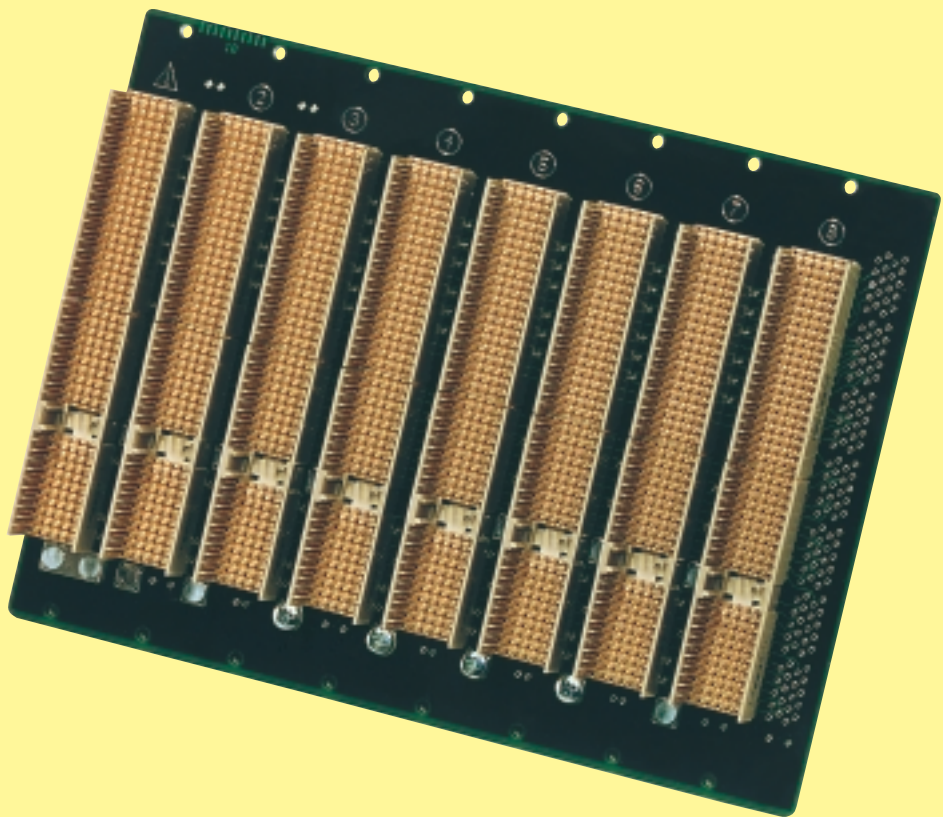

The industrial market which is often described as 'embedded and real-time', has started to move from ISA to CompactPCI<sup>®</sup>. Proprietary bus systems is the major growth for CompactPCI<sup>®</sup>. The forecasters agree that the majority of medium and large systems could easily adopt both VME and CompactPCI<sup>®</sup> in any given application. The main would be controlled by CompactPCI<sup>®</sup> and real-time high-end application subsystems calling for VME.

## harbus<sup>®</sup> HM the 2.0mm hard metric system from HARTING

### Comparison of 2.0 mm systems

For many years board-to backplane connectors were dominated by DIN connectors with a pitch of 2.54 mm. The advances of new designs in recent years have migrated to 2.0 mm pitch connectors. However, today there are three separate and non-compatible 2.0 mm style connector families available on the market: Futurebus+ style, HDM<sup>®</sup> and hard metric style.

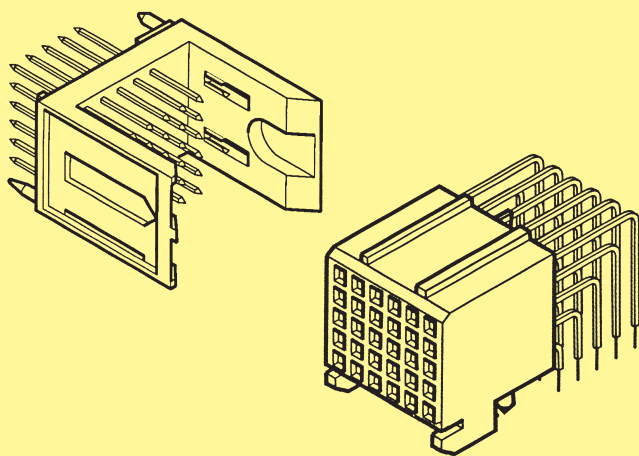

Several years ago Futurbus+ and telecom applications standardised on a modular 2.0 mm connector using increments of 12 mm. These connectors are currently undergoing IEC standardisation (IEC 61076-4-104). They are also specified for Industrial PCI systems.

Another 2.0 mm connector specification available today is commonly referred to as HDM<sup>®</sup>, HDM<sup>®</sup>plus or VHDM. These connectors come in 22 mm and 46 mm increments.

This proprietary system is not standardised therefore, unable to provide a high degree of intermatibility.

For high speed applications like CompactPCI<sup>®</sup> the hard-metric connector, such as har-bus<sup>®</sup> HM from HARTING, was chosen. It is a modular 2 mm connector using increments of 25 mm. CompactPCI<sup>®</sup> has specified two connectors J1/P1 and J2/P2 for 3U cards and five connectors (J1/P1 - J5/P5) for 6U cards. On 3U Eurocards two full size 50 mm

connectors will not assemble to a 100 mm card height because of space needed for guide rails. The type B connector is therefore shortened to 22 rows or 44 mm length. J4/P4 and J5/P5 on 6U cards are mirror images of J1/P1 and J2/P2 respectively. The centre connector J3/P3 on 6U has 19 rows of pins. This 19 row version is also used as the centre connector J0/P0 on 6U VME boards.

The popular configuration of 2.0 mm hard metric connectors are 5 rows of signal contacts and one or two rows of outer shield or ground contacts. The increase in pin-count over the popular DIN connector (IEC & EN 60603-2) is quite significant, 96 to 240 contacts. The enhanced or 5-row DIN compatible connector (har-bus<sup>®</sup> 64) originated by HARTING, has 160 contacts on a 2.54 mm pitch.

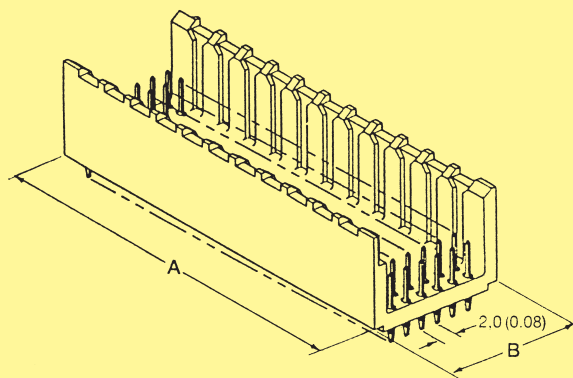
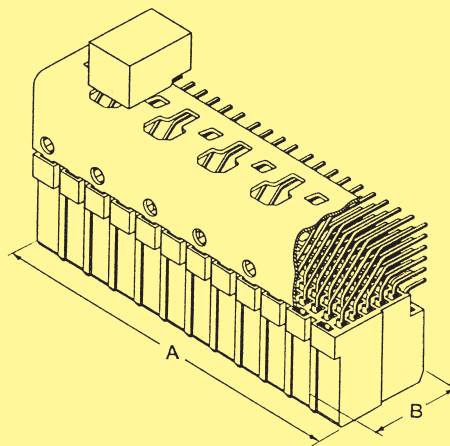

The IEC 61076-4-101 hard metric connector has been designed for high-speed applications with appropriate shielding options. It is specified for CompactPCI<sup>®</sup>, VMEbus and proprietary applications. Further standardisation is being developed by VITA as a mechanical practice guide, VITA 30 Draft standard.

## Technical characteristics

- Number of contacts : 55 – 220 signal, 66 – 308 inclusive shield and customized loadings
- Contact spacing : 2.00 mm
- Working current : 1.5 ADC (Signal)
- Test voltage  $U_{r.m.s.}$  : AC 750 V min.
- Contact resistance : 20 mΩ max.
- Insulation resistance: 10 GΩ min.
- Temperature range : – 55 °C ... + 125 °C
- Durability : depending on the performance level
- Press-in force : 100 N/pin max.
- Retention force : 20 N/pin min.
- Mating force : 0.75 N/pin max.
- Withdrawal force : 0.15 N/pin min.

### Materials

- Mouldings : Thermoplastic resin, glass-fibre filled, UL 94 V-0
- Contacts : Copper alloy
- Contact surface : Au
- Packaging : Tube (standard) or cardboard box

## Contacts for male connectors

HARTING offers 12 different contact lengths for harbus® HM male connectors: the standard mating length of 8.2 mm, pre-leading contacts with 9.7 mm and extra long contacts preferred for shielding with 11.2 mm mating length. On the termination side the standard length is 3.7 mm. With the three termination lengths of 13.0, 14.5 and 16.0 mm even for rear I/O applications different mating levels are possible, depending on the PCB thickness and shroud height.

All contacts are offered as press-in form with needle eye termination. In accordance of the application they can be delivered in performance level 1 or 2. The different contact lengths are designated with letters to identify them in the configurations given in this catalogue. For special loadings please use the customer request form at the end of this catalogue.

Contact dimensions [mm]

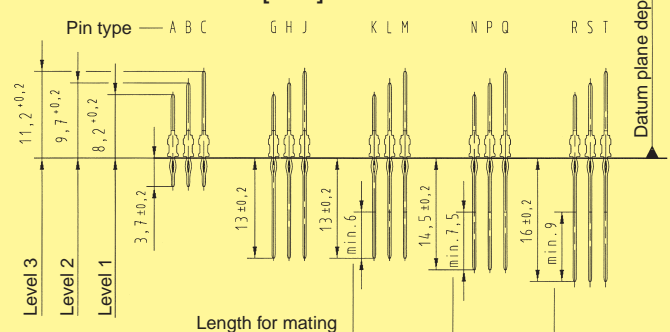

## Press-in technique

HARTING has developed the whole range of har-bus<sup>®</sup> HM in press-in technique. More and more customers chose this reliable design due to the fact that the press-in technique offers a lot of benefits in comparison to other termination methods.

### The economical and technical advantages are:

- Thermal shocks due to the soldering process are avoided
- No need for subsequent cleaning of the assembled boards
- High assembly speed
- Defined impedances guarantee well HF-characteristics



## PCB specification

- Diameter of drilled hole:  $0.7 \pm 0.02$  mm
- Diameter of finished through hole:  $0.6 \pm 0.05$  mm
- PCB thickness: for male connector: 1.4 mm min.  
for female connector: 1.4 mm min.

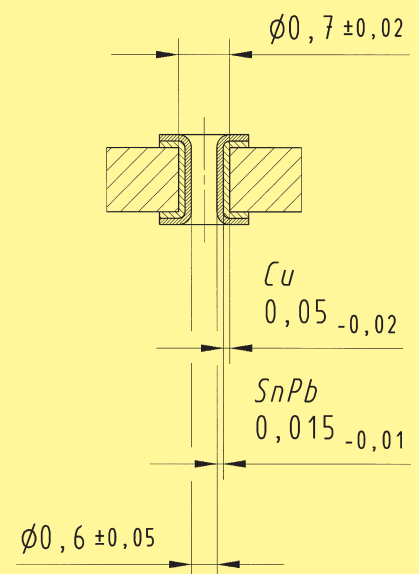

## Maximum circuit density

When using the recommended diameter of the finished through hole ( $0.6 \pm 0.05$  mm) with an appropriate annular ring, the remaining distance between the rings is about 1 mm. Under the condition that the width of the track and the space between should be the equal, two tracks of 0.2 mm width or three tracks of 0.14 mm width can be placed between two rings. Typical designs are shown in the drawing on the right side.

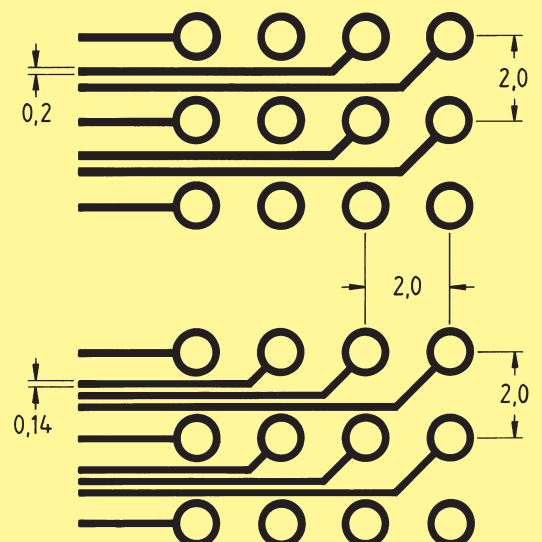

## Typical configurations on PCB

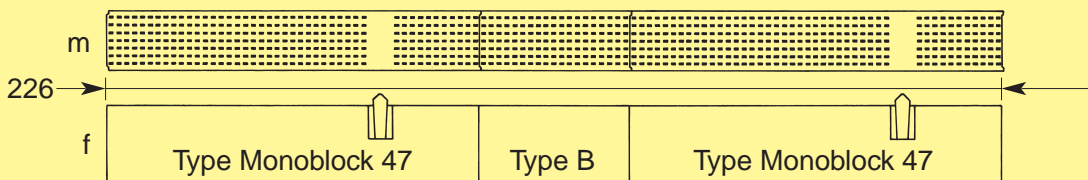
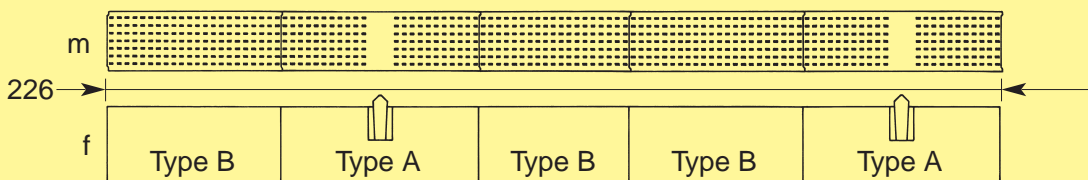
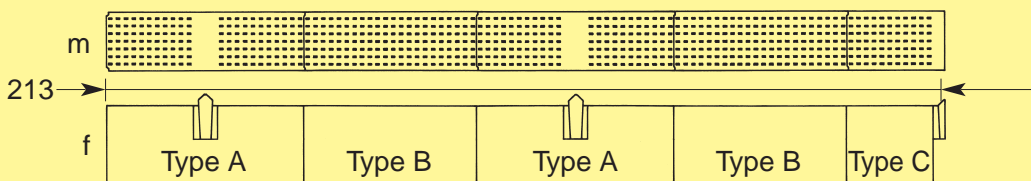
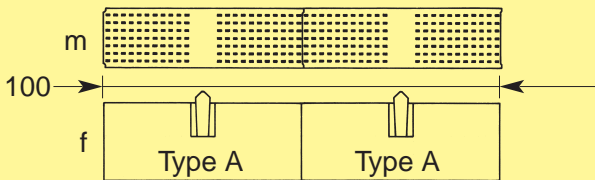
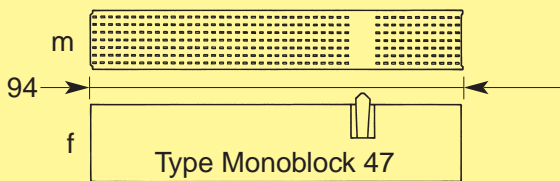
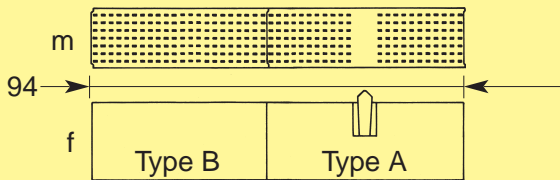
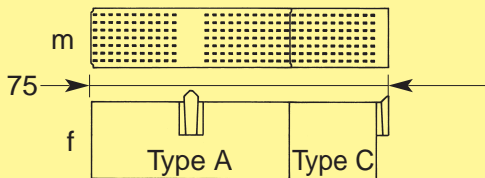
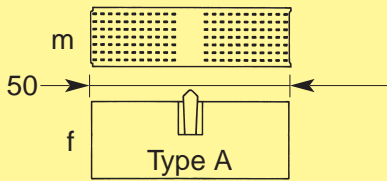

All HARTING har-bus<sup>®</sup> HM connectors can be assembled end to end in any order. Typical examples are shown in the picture above.

General rules:

- Type B connectors should always be used in combination with a type A and/or type C connectors that are fitted with a polarising and guiding peg.
- Type C connectors must be assembled at the end of a connector stack, to get a polarisation and avoid mismatching.
- To ensure a correct mating of connector stacks coding can be added in style A connectors. By using all available styles the stacks have a minimum length of 50 mm (style A) that can be increased in stages as shown in the diagram.

m = male connector

f = female connector

Dimensions [mm]



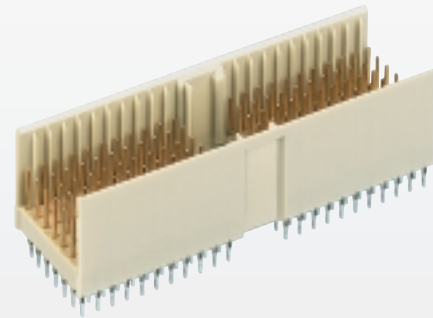

Type A  
Male connectors, straight

Identification	Number of contacts	Contact length [mm] mating side	termination side	Part number	Contact configuration
Type A	110	8.2	3.7	17 01 110 1201 <b>17 01 110 2201</b>	
Type A	154	8.2/ 11.2	3.7	17 01 154 1201 <b>17 01 154 2201</b>	
Type A	110	9.7	3.7	17 01 110 1204 <b>17 01 110 2204</b>	
Type A	154	9.7/ 11.2	3.7	17 01 154 1205 <b>17 01 154 2205</b>	

Contact dimensions [mm]

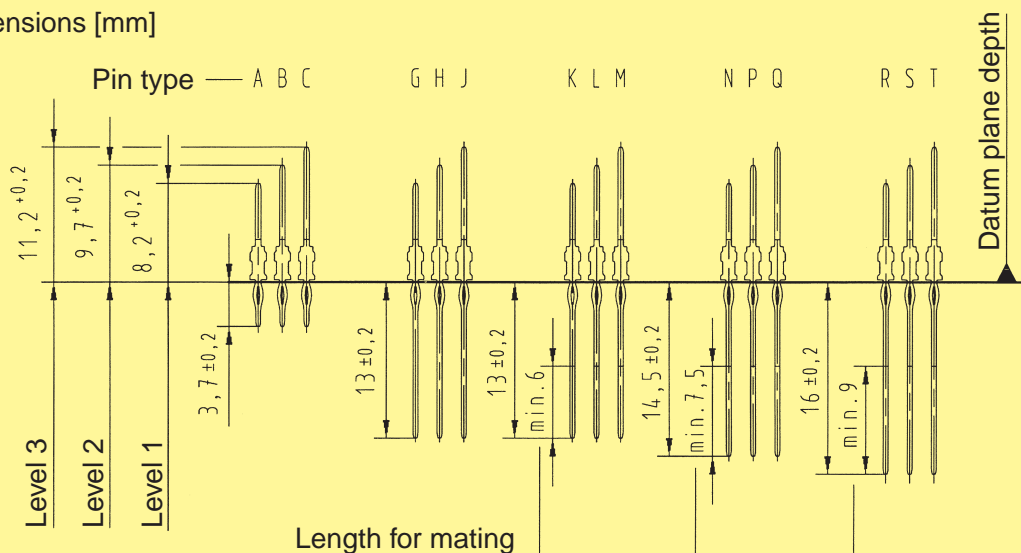

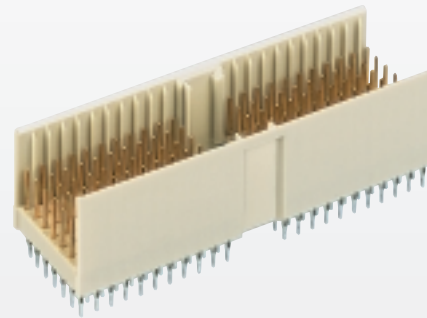

Type A  
Male connectors, straight

Identification	Number of contacts	Contact length [mm] mating side	termination side	Part number	Contact configuration
Type A	110	8.2	13.0	17 01 110 1402 <b>17 01 110 2402</b>	
Type A	154	9.7/ 11.2	14.5/ 16.0	17 01 154 1001 <b>17 01 154 2001</b>	
Type A, CompactPCI	154	8.2/ 9.7/ 11.2	3.7	17 01 154 1203 <b>17 01 154 2203</b>	
Type A, CompactPCI hot swap	154	8.2/ 9.7/ 11.2	3.7	17 01 154 1204 <b>17 01 154 2204</b>	

Contact dimensions [mm]

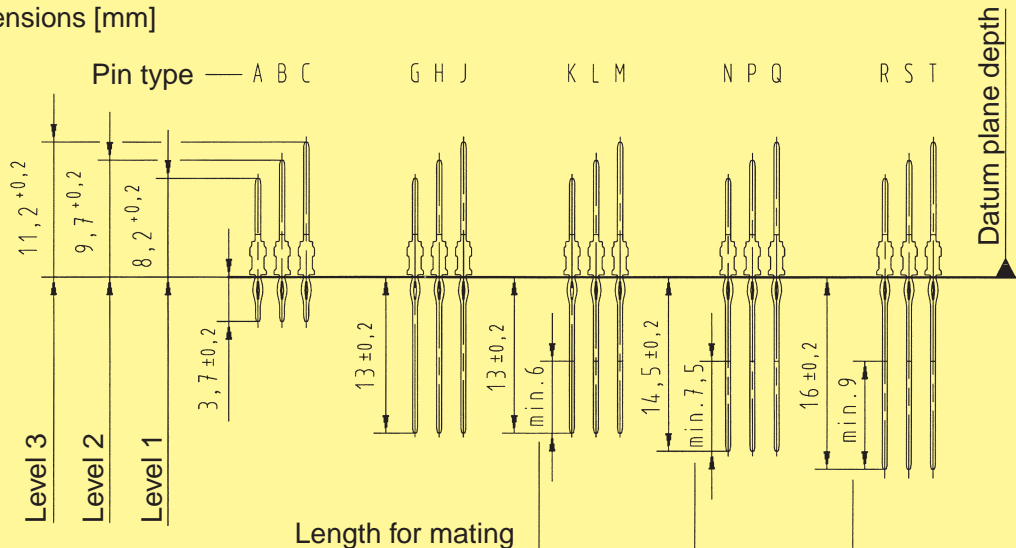

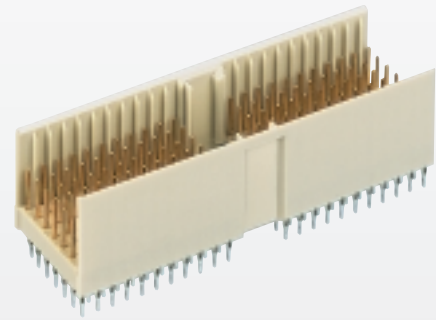

Type A  
Male connectors, straight

Identification	Number of contacts	Contact length [mm] mating side	termination side	Part number	Contact configuration																																																																																																																																																													
Type A CompactPCI computer telephony	100	8.2/ 9.7/ 11.2	13.0/ 14.5/ 16.0	17 01 100 1001 <b>17 01 100 2001</b>	<table border="1"> <tr><td>P</td><td>P</td><td>P</td><td>P</td><td>P</td><td>P</td><td>P</td><td>P</td><td>P</td><td>P</td><td>T</td><td>P</td><td>T</td><td>P</td><td>P</td><td>P</td><td>P</td><td>Z</td></tr> <tr><td>P</td><td>P</td><td>P</td><td>P</td><td>P</td><td>P</td><td>P</td><td>P</td><td>P</td><td>P</td><td></td><td></td><td></td><td>P</td><td>P</td><td>P</td><td>P</td><td>a</td></tr> <tr><td>P</td><td>P</td><td>P</td><td>P</td><td>P</td><td>P</td><td>P</td><td>P</td><td>P</td><td>P</td><td></td><td></td><td></td><td>P</td><td>P</td><td>K</td><td>P</td><td>b</td></tr> <tr><td>P</td><td>P</td><td>T</td><td>T</td><td>T</td><td>T</td><td>T</td><td>T</td><td>T</td><td>T</td><td></td><td></td><td></td><td>P</td><td>P</td><td>P</td><td>P</td><td>c</td></tr> <tr><td>P</td><td>T</td><td>P</td><td>P</td><td>P</td><td>P</td><td>P</td><td>P</td><td>P</td><td>P</td><td>T</td><td>P</td><td></td><td>T</td><td>P</td><td>P</td><td>P</td><td>d</td></tr> <tr><td>T</td><td>T</td><td>T</td><td>T</td><td>T</td><td>T</td><td>T</td><td>T</td><td>T</td><td>T</td><td></td><td></td><td></td><td>T</td><td>T</td><td>T</td><td>T</td><td>e</td></tr> <tr><td></td><td></td><td></td><td></td><td></td><td></td><td></td><td></td><td></td><td></td><td></td><td></td><td></td><td></td><td></td><td></td><td></td><td>f</td></tr> <tr><td>25</td><td>24</td><td>23</td><td>22</td><td>21</td><td>20</td><td>19</td><td>18</td><td>17</td><td>16</td><td>15</td><td></td><td></td><td>11</td><td>10</td><td>9</td><td>8</td><td>7</td><td>6</td><td>5</td><td>4</td><td>3</td><td>2</td><td>1</td></tr> </table>	P	P	P	P	P	P	P	P	P	P	T	P	T	P	P	P	P	Z	P	P	P	P	P	P	P	P	P	P				P	P	P	P	a	P	P	P	P	P	P	P	P	P	P				P	P	K	P	b	P	P	T	T	T	T	T	T	T	T				P	P	P	P	c	P	T	P	P	P	P	P	P	P	P	T	P		T	P	P	P	d	T	T	T	T	T	T	T	T	T	T				T	T	T	T	e																		f	25	24	23	22	21	20	19	18	17	16	15			11	10	9	8	7	6	5	4	3	2	1							
P	P	P	P	P	P	P	P	P	P	T	P	T	P	P	P	P	Z																																																																																																																																																	
P	P	P	P	P	P	P	P	P	P				P	P	P	P	a																																																																																																																																																	
P	P	P	P	P	P	P	P	P	P				P	P	K	P	b																																																																																																																																																	
P	P	T	T	T	T	T	T	T	T				P	P	P	P	c																																																																																																																																																	
P	T	P	P	P	P	P	P	P	P	T	P		T	P	P	P	d																																																																																																																																																	
T	T	T	T	T	T	T	T	T	T				T	T	T	T	e																																																																																																																																																	
																	f																																																																																																																																																	
25	24	23	22	21	20	19	18	17	16	15			11	10	9	8	7	6	5	4	3	2	1																																																																																																																																											
Type A CompactPCI computer telephony	100	8.2/ 9.7/ 11.2	3.7	17 01 100 1201 <b>17 01 100 2201</b>	<table border="1"> <tr><td>B</td><td>B</td><td>B</td><td>B</td><td>B</td><td>B</td><td>B</td><td>B</td><td>B</td><td>B</td><td>B</td><td>C</td><td>B</td><td>C</td><td>B</td><td>B</td><td>B</td><td>B</td><td>Z</td></tr> <tr><td>B</td><td>B</td><td>B</td><td>B</td><td>B</td><td>B</td><td>B</td><td>B</td><td>B</td><td>B</td><td>B</td><td></td><td></td><td></td><td>B</td><td>B</td><td>B</td><td>B</td><td>a</td></tr> <tr><td>B</td><td>B</td><td>B</td><td>B</td><td>B</td><td>B</td><td>B</td><td>B</td><td>B</td><td>B</td><td>B</td><td></td><td></td><td></td><td>B</td><td>B</td><td>A</td><td>B</td><td>b</td></tr> <tr><td>B</td><td>B</td><td>C</td><td>C</td><td>C</td><td>C</td><td>C</td><td>C</td><td>C</td><td>C</td><td>C</td><td></td><td></td><td></td><td>B</td><td>B</td><td>B</td><td>B</td><td>c</td></tr> <tr><td>B</td><td>C</td><td>B</td><td>B</td><td>B</td><td>B</td><td>B</td><td>B</td><td>B</td><td>B</td><td>B</td><td>C</td><td>B</td><td></td><td>C</td><td>B</td><td>B</td><td>B</td><td>d</td></tr> <tr><td>C</td><td>C</td><td>C</td><td>C</td><td>C</td><td>C</td><td>C</td><td>C</td><td>C</td><td>C</td><td>C</td><td></td><td></td><td></td><td>C</td><td>C</td><td>C</td><td>C</td><td>e</td></tr> <tr><td></td><td></td><td></td><td></td><td></td><td></td><td></td><td></td><td></td><td></td><td></td><td></td><td></td><td></td><td></td><td></td><td></td><td></td><td>f</td></tr> <tr><td>25</td><td>24</td><td>23</td><td>22</td><td>21</td><td>20</td><td>19</td><td>18</td><td>17</td><td>16</td><td>15</td><td></td><td></td><td>11</td><td>10</td><td>9</td><td>8</td><td>7</td><td>6</td><td>5</td><td>4</td><td>3</td><td>2</td><td>1</td></tr> </table>	B	B	B	B	B	B	B	B	B	B	B	C	B	C	B	B	B	B	Z	B	B	B	B	B	B	B	B	B	B	B				B	B	B	B	a	B	B	B	B	B	B	B	B	B	B	B				B	B	A	B	b	B	B	C	C	C	C	C	C	C	C	C				B	B	B	B	c	B	C	B	B	B	B	B	B	B	B	B	C	B		C	B	B	B	d	C	C	C	C	C	C	C	C	C	C	C				C	C	C	C	e																			f	25	24	23	22	21	20	19	18	17	16	15			11	10	9	8	7	6	5	4	3	2	1
B	B	B	B	B	B	B	B	B	B	B	C	B	C	B	B	B	B	Z																																																																																																																																																
B	B	B	B	B	B	B	B	B	B	B				B	B	B	B	a																																																																																																																																																
B	B	B	B	B	B	B	B	B	B	B				B	B	A	B	b																																																																																																																																																
B	B	C	C	C	C	C	C	C	C	C				B	B	B	B	c																																																																																																																																																
B	C	B	B	B	B	B	B	B	B	B	C	B		C	B	B	B	d																																																																																																																																																
C	C	C	C	C	C	C	C	C	C	C				C	C	C	C	e																																																																																																																																																
																		f																																																																																																																																																
25	24	23	22	21	20	19	18	17	16	15			11	10	9	8	7	6	5	4	3	2	1																																																																																																																																											

Contact dimensions [mm]

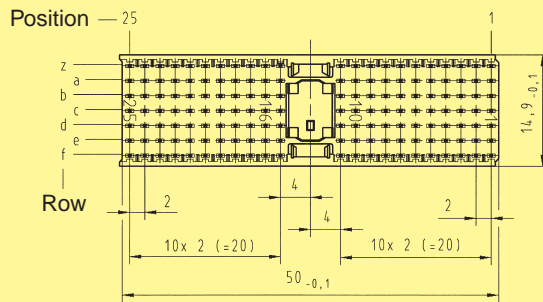
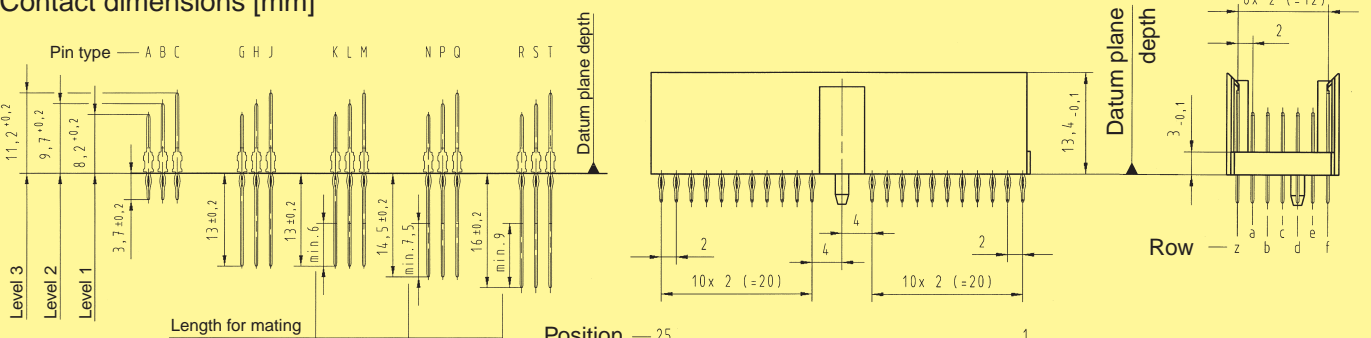

Board drillings

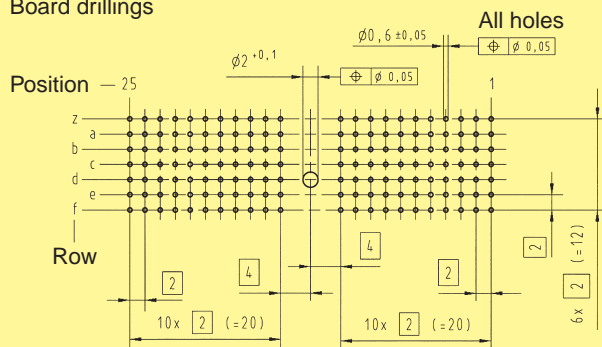

Dimensions [mm]

Thin printed part numbers: performance level 1  
**Bold printed part numbers: performance level 2**

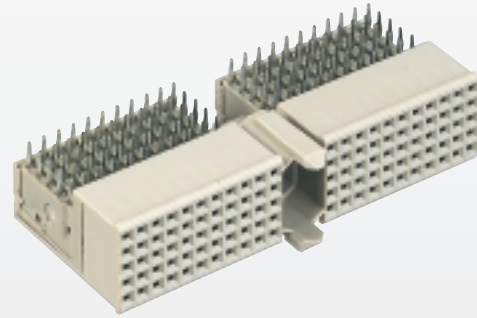

Type A  
Female connectors, angled

Identification	No. of contacts	Contact length [mm] termination side	Part number
Type A	110	3.4	17 21 110 1101 <b>17 21 110 2101</b>
Type A, with pre-installed upper shield	110	3.4	17 21 110 1102 <b>17 21 110 2102</b>
Lower shield for type A connectors			17 21 000 4102
Type A, with pre-installed upper shield CompactPCI computer telephony	90	3.4	17 21 090 1103 <b>17 21 090 2103</b>
Lower shield for type A connectors (rows 1 – 5), CompactPCI computer telephony			17 29 000 4102
Lower shield for type A connectors (rows 15 – 25), CompactPCI computer telephony			17 23 000 4102

Without shielding

With shielding

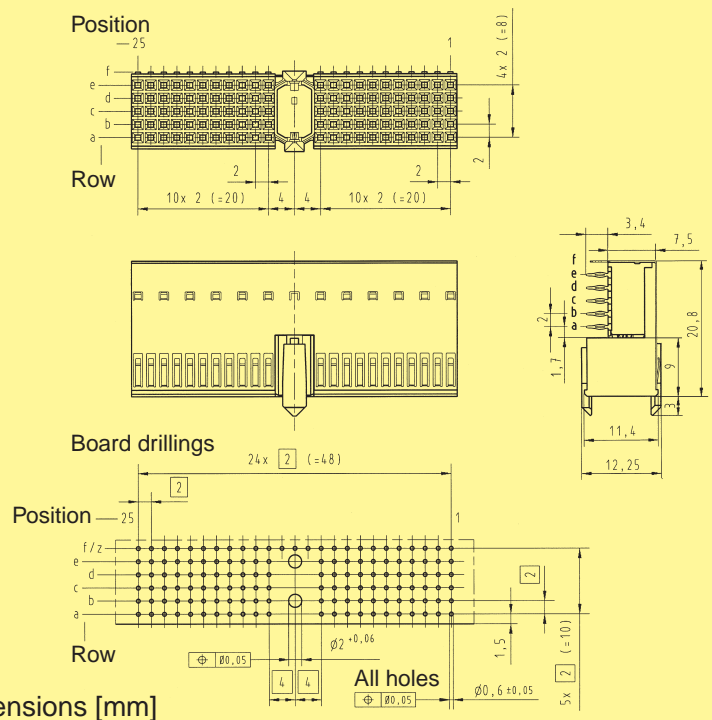
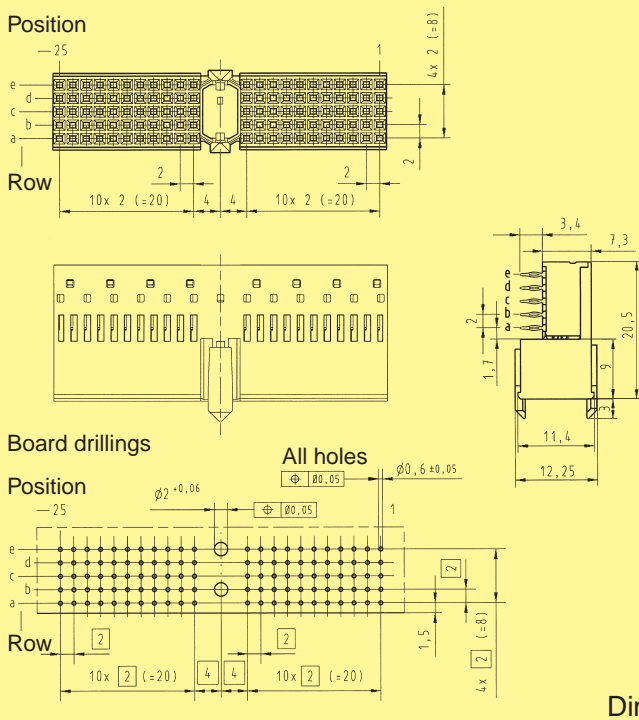

Dimensions [mm]

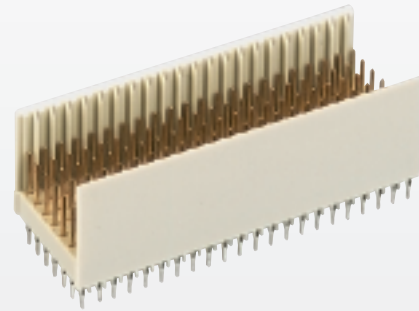

Type B  
Male connectors, straight

Identification	Number of contacts	Contact length [mm] mating side	termination side	Part number	Contact configuration
Type B	125	8.2	3.7	17 02 125 1201 <b>17 02 125 2201</b>	
Type B	175	8.2/ 11.2	3.7	17 02 175 1201 <b>17 02 175 2201</b>	
Type B	175	8.2/ 9.7/ 11.2	3.7	17 02 175 1202 <b>17 02 175 2202</b>	
Type B	110	8.2	3.7	17 04 110 1201 <b>17 04 110 2201</b>	

Contact dimensions [mm]

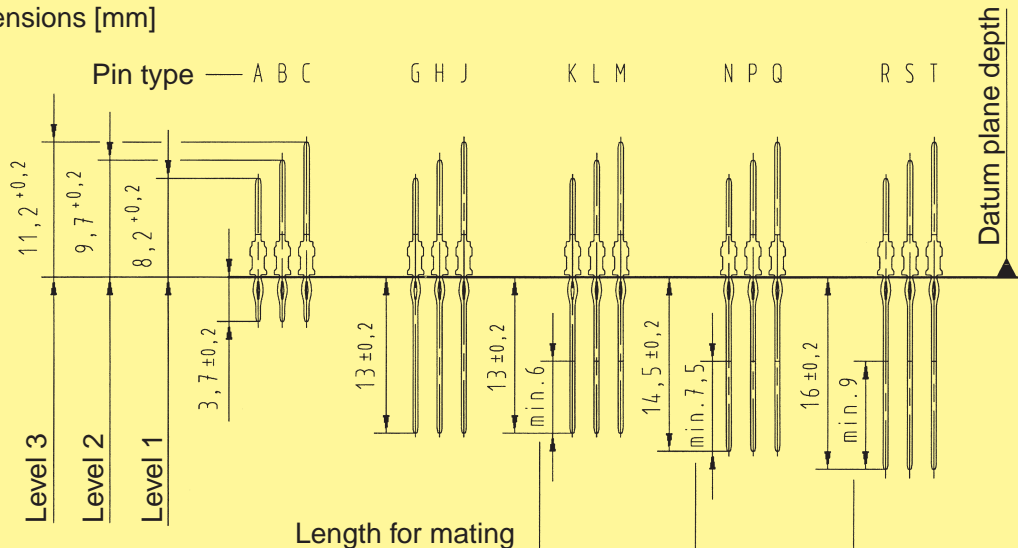

Thin printed part numbers: performance level 1  
**Bold printed part numbers: performance level 2**

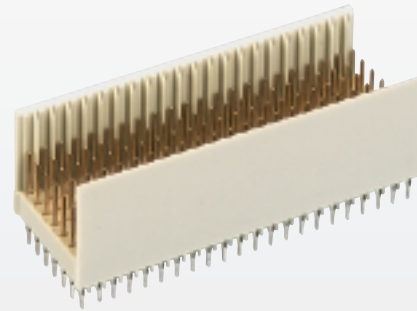

Type B  
Male connectors, straight

Identification	Number of contacts	Contact length [mm] mating side	termination side	Part number	Contact configuration
Type B	154	8.2/ 11.2	3.7	17 04 154 1201 <b>17 04 154 2201</b>	
Type B, CompactPCI	154	9.7/ 11.2	3.7	17 04 154 1203 <b>17 04 154 2203</b>	
Type B, CompactPCI computer telephony	132	8.2/ 9.7/ 11.2	13.0/ 14.5/ 16.0	17 04 132 1001 <b>17 04 132 2001</b>	
Type B, CompactPCI computer telephony	154	8.2/ 9.7/ 11.2	3.7	17 04 154 1204 <b>17 04 154 2204</b>	

Contact dimensions [mm]

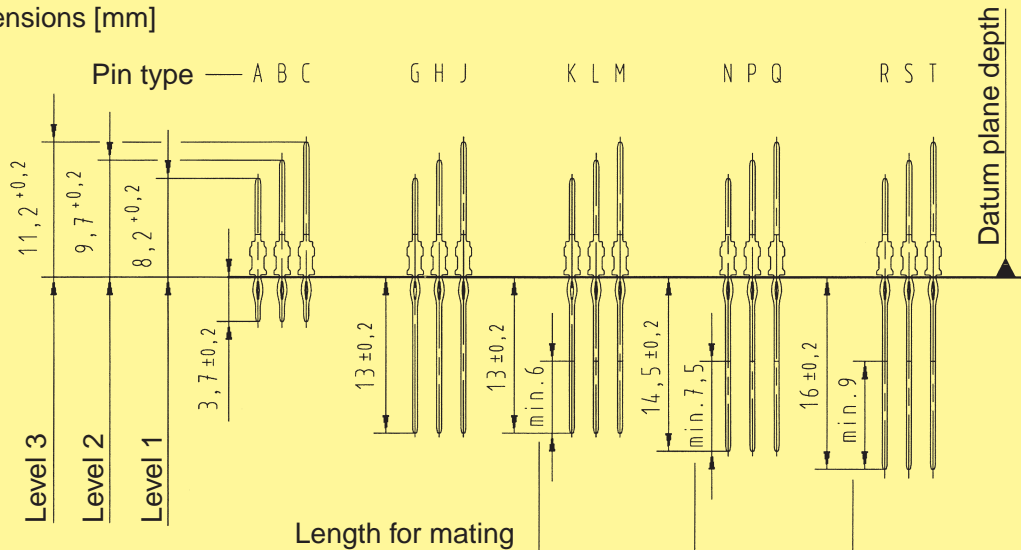

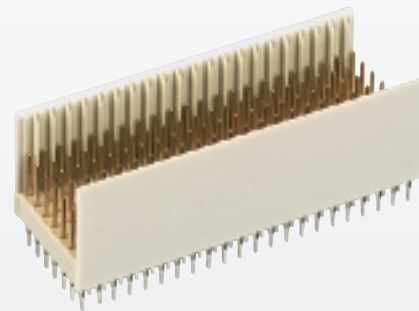

Type B  
Male connectors, straight

Identification	Number of contacts	Contact length [mm] mating side	termination side	Part number	Contact configuration
Type B, CompactPCI computer telephony	132	8.2/ 9.7/ 11.2	3.7	17 04 132 1201 <b>17 04 132 2201</b>	
Type B, CompactPCI I/O	154	9.7/ 11.2	16.0	17 04 154 1601 <b>17 04 154 2601</b>	
Type B	95	8.2	3.7	17 05 095 1201 <b>17 05 095 2201</b>	
Type B	133	8.2/ 11.2	3.7	17 05 133 1201 <b>17 05 133 2201</b>	

Contact dimensions [mm]

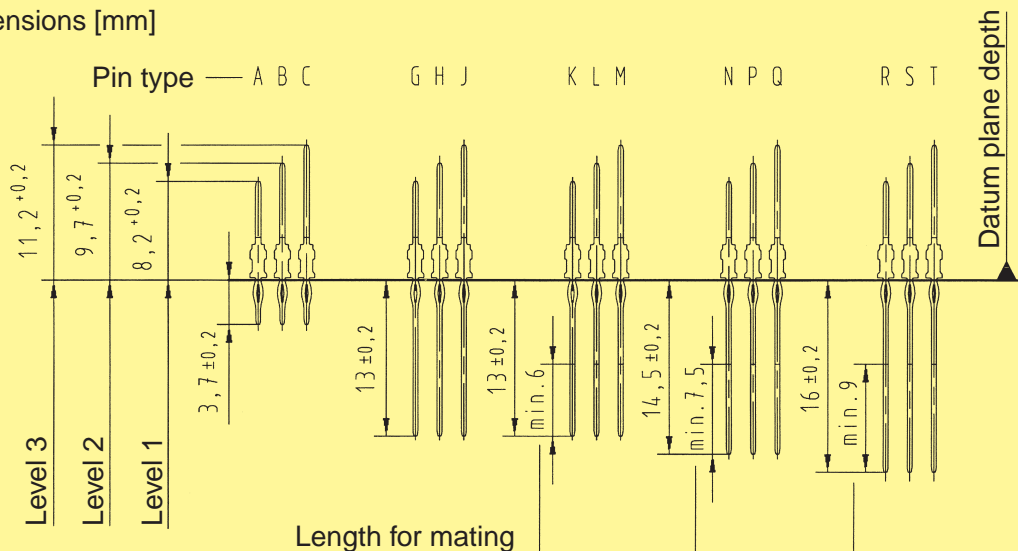

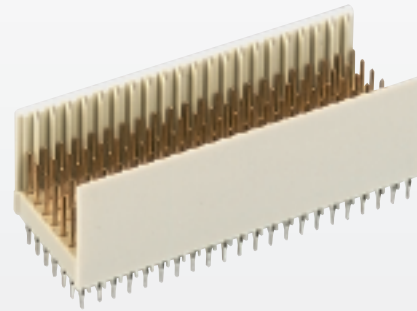

Type B  
Male connectors, straight

Identification	Number of contacts	Contact length [mm] mating side	termination side	Part number	Contact configuration
Type B	133	9.7/ 11.2	3.7	17 05 133 1203 <b>17 05 133 2203</b>	
Type B	95	8.2	13.0	17 05 095 1401 <b>17 05 095 2401</b>	

Contact dimensions [mm]

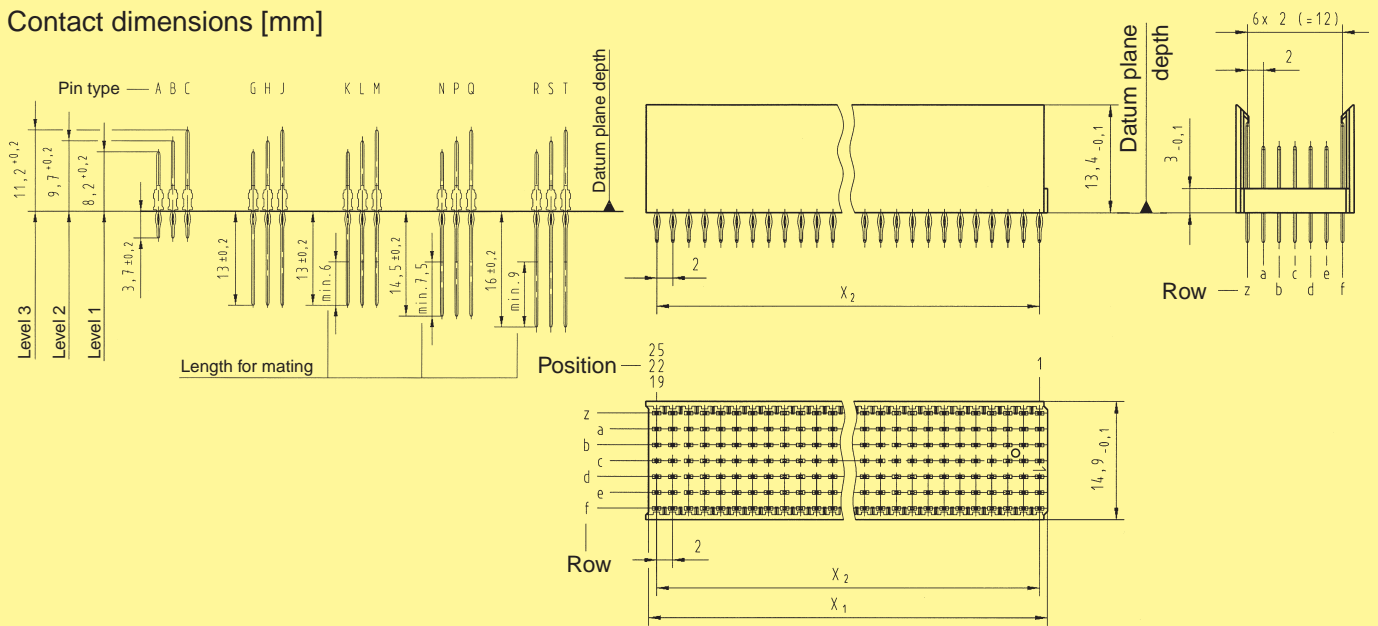

Board drillings

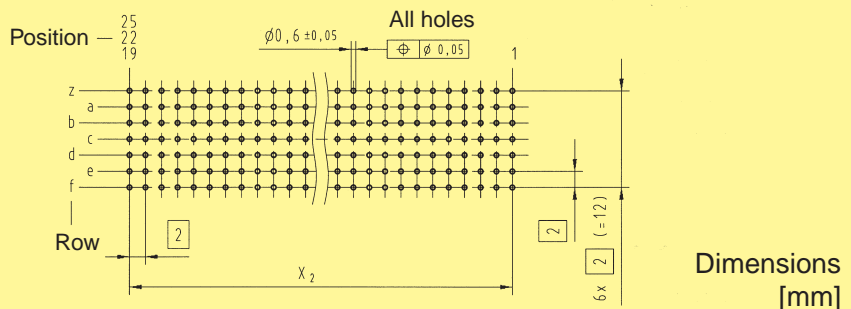

Contact positions	X <sub>1</sub>	X <sub>2</sub>
19	37.9	18 x <b>2</b> (= 36)
22	43.9	21 x <b>2</b> (= 42)
25	49.9	24 x <b>2</b> (= 48)



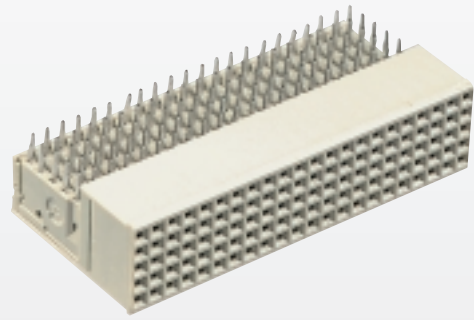

Type B  
Female connectors, angled

Identification	No. of contacts	Contact length [mm]		Part number
			termination side	
Type B	95	3.4		17 25 095 1101 <b>17 25 095 2101</b>
Type B, with pre-installed upper shield	95	3.4		17 25 095 1102 <b>17 25 095 2102</b>
Lower shield for type B connectors with 95 contacts				17 25 000 4102
Type B	110	3.4		17 24 110 1101 <b>17 24 110 2101</b>
Type B, with pre-installed upper shield	110	3.4		17 24 110 1102 <b>17 24 110 2102</b>
Lower shield for type B connectors with 110 contacts				17 24 000 4102
Type B	125	3.4		17 22 125 1101 <b>17 22 125 2101</b>
Type B, with pre-installed upper shield	125	3.4		17 22 125 1102 <b>17 22 125 2102</b>
Lower shield for type B connectors with 125 contacts				17 22 000 4102

Contact positions	X <sub>1</sub>	X <sub>2</sub>
19	37.9	18 x <b>2</b> (= 36)
22	43.9	21 x <b>2</b> (= 42)
25	49.9	24 x <b>2</b> (= 48)

Dimensions [mm]

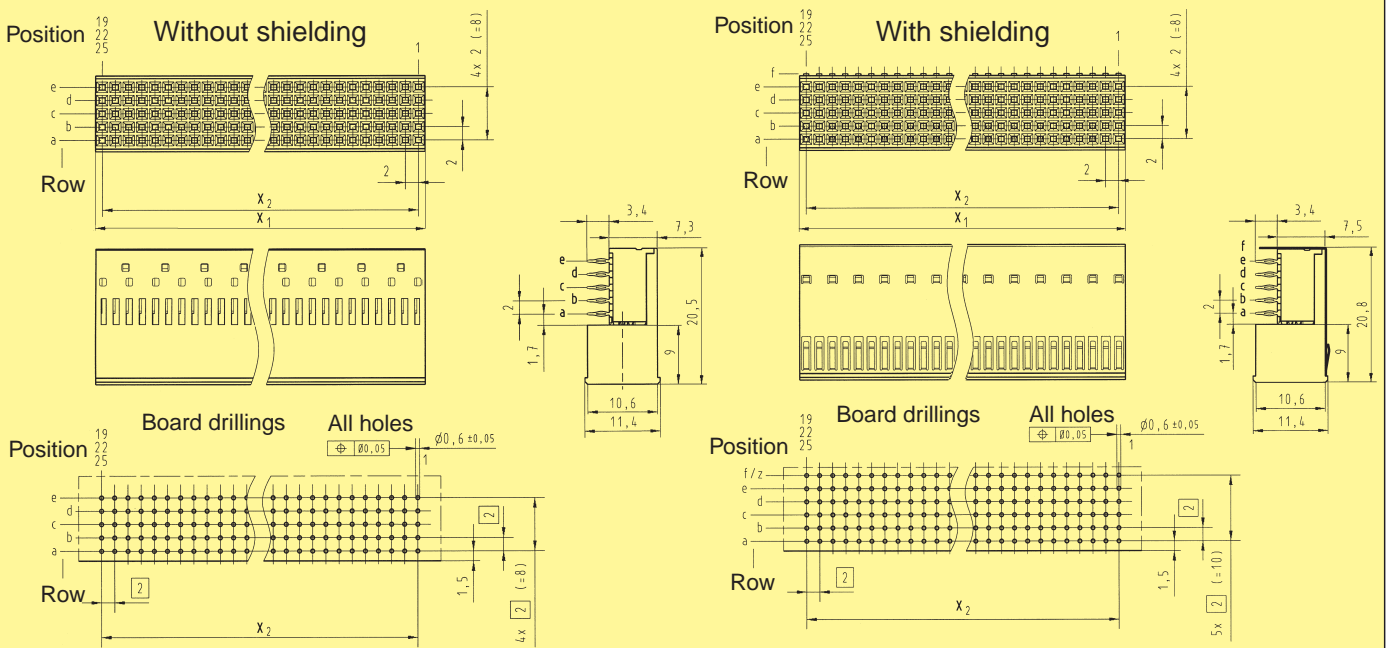

Thin printed part numbers: performance level 1  
**Bold printed part numbers: performance level 2**

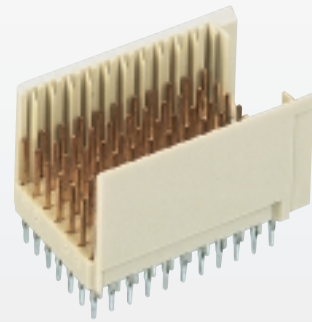

Type C  
Male connectors, straight

Identification	Number of contacts	Contact length [mm] mating side	termination side	Part number	Contact configuration
Type C	55	8.2	3.7	17 03 055 1201 <b>17 03 055 2201</b>	
Type C	77	8.2/ 11.2	3.7	17 03 077 1201 <b>17 03 077 2201</b>	
Type C	55	9.7	3.7	17 03 055 1202 <b>17 03 055 2202</b>	
Type C	77	9.7/ 11.2	3.7	17 03 077 1202 <b>17 03 077 2202</b>	

Contact dimensions [mm]

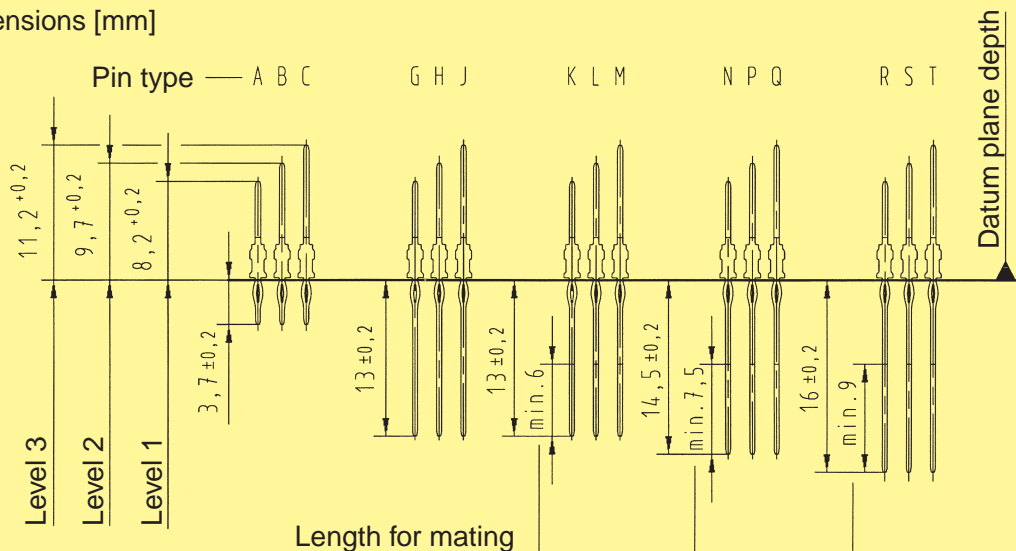

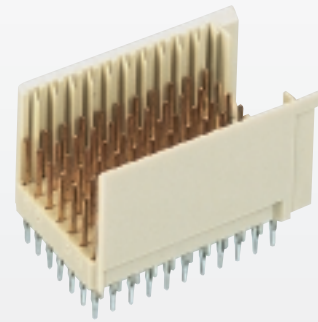

Type C  
Male connectors, straight

Identification	Number of contacts	Contact length [mm] mating side	termination side	Part number	Contact configuration
Type C	55	8.2	13.0	17 03 055 1401 <b>17 03 055 2401</b>	
Type C	77	8.2/ 11.2	3.7/ 13.0	17 03 077 1001 <b>17 03 077 2001</b>	

Contact dimensions [mm]

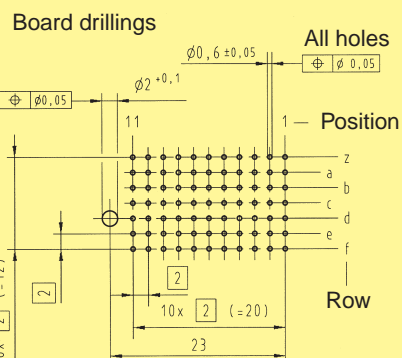
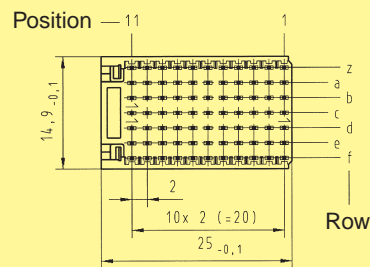
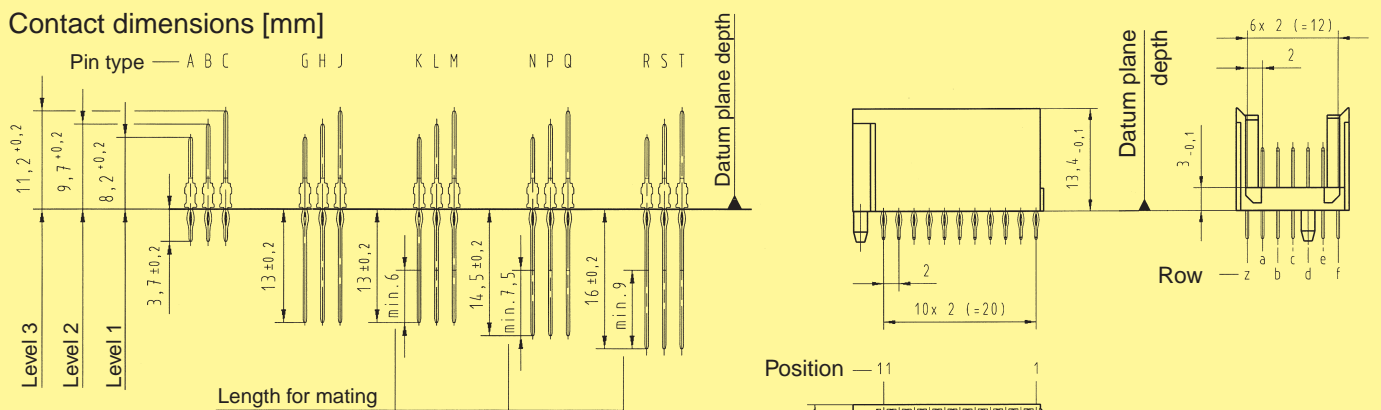

Dimensions [mm]

Thin printed part numbers: performance level 1  
**Bold printed part numbers: performance level 2**

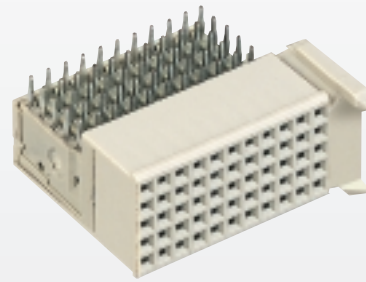

Type C  
Female connectors, angled

Identification	No. of contacts	Contact length [mm] termination side	Part number
Type C	55	3.4	17 23 055 1101 <b>17 23 055 2101</b>
Type C, with pre-installed upper shield	55	3.4	17 23 055 1102 <b>17 23 055 2102</b>
Lower shield for type C connectors			17 23 000 4102

Without shielding

With shielding

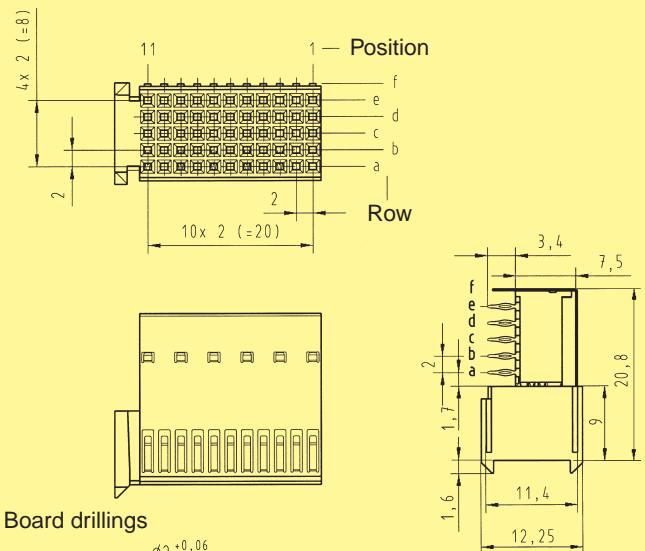
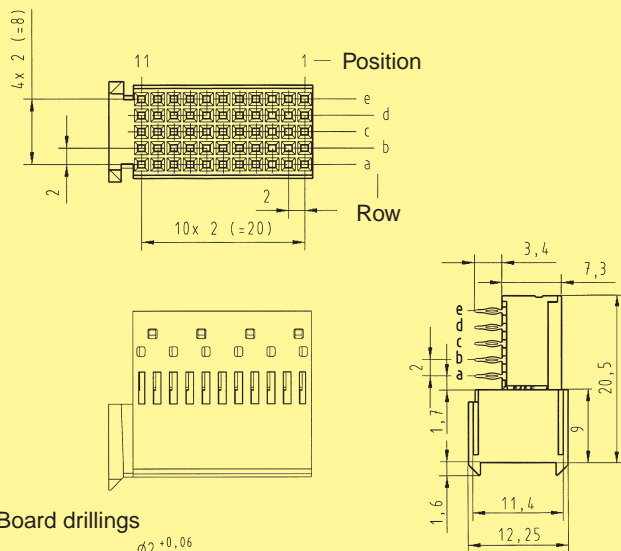

Board drillings

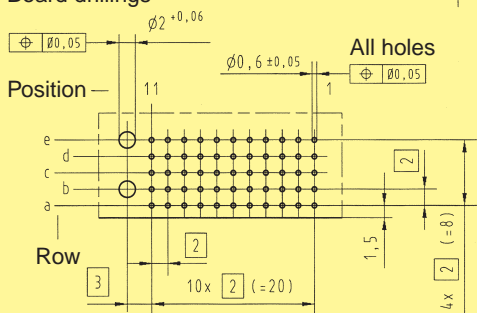

Board drillings

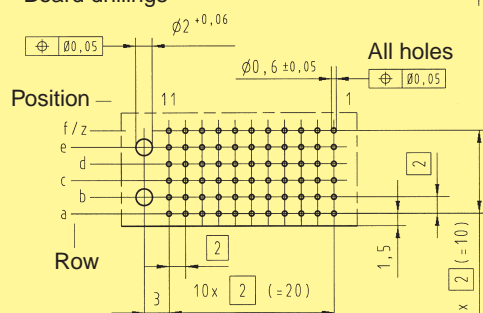

Dimensions [mm]

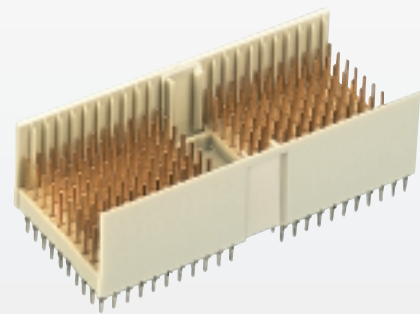

Type D  
Male connectors, straight

Identification	Number of contacts	Contact length [mm] mating side	termination side	Part number	Contact configuration
Type D	176	8.2	3.7	17 11 176 1201 <b>17 11 176 2201</b>	
Type D	220	8.2/ 11.2	3.7	17 11 220 1201 <b>17 11 220 2201</b>	
Type D	220	9.7/ 11.2	14.5/ 16.0	17 11 220 1001 <b>17 11 220 2001</b>	

Contact dimensions [mm]

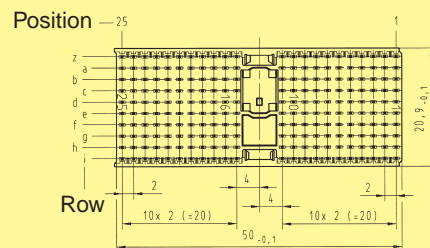
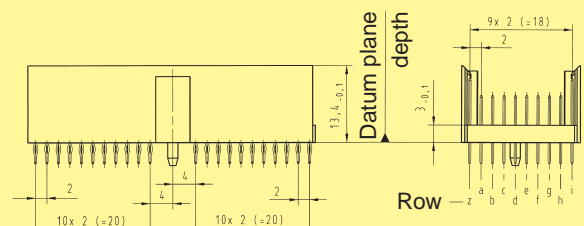
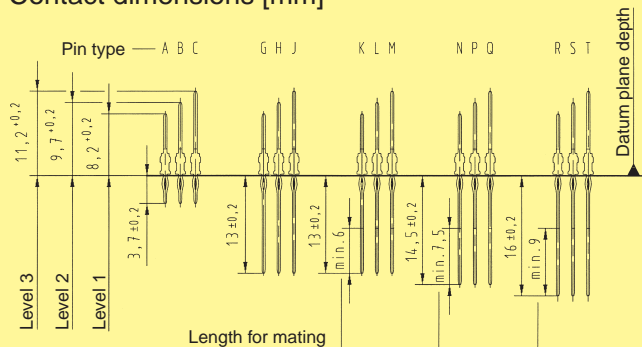

Board drillings

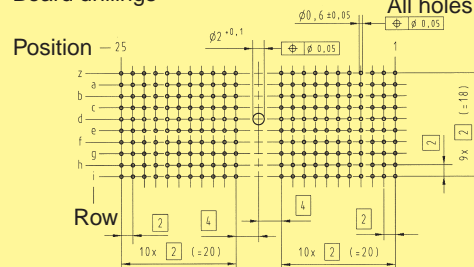

Dimensions [mm]

Thin printed part numbers: performance level 1  
**Bold printed part numbers: performance level 2**

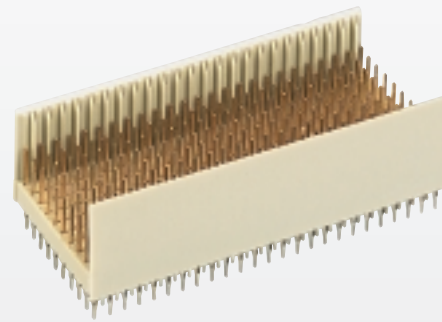

Type E  
Male connectors, straight

Identification	Number of contacts	Contact length [mm] mating side	termination side	Part number	Contact configuration
Type E	200	8.2	3.7	17 12 200 1201 <b>17 12 200 2201</b>	
Type E	250	8.2/ 11.2	3.7	17 12 250 1201 <b>17 12 250 2201</b>	
Type E	250	9.7/ 11.2	14.5/ 16.0	17 12 250 1001 <b>17 12 250 2001</b>	

Contact dimensions [mm]

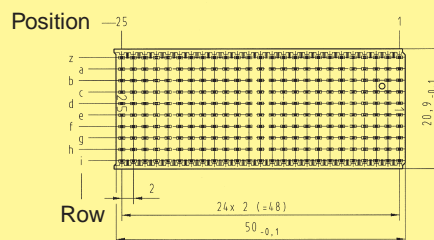
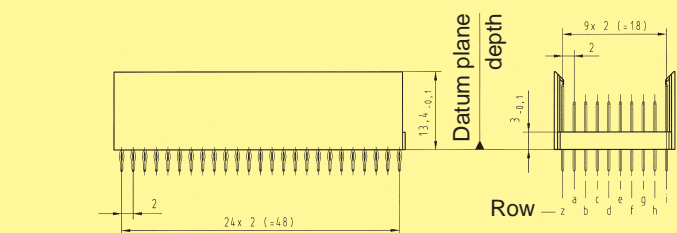
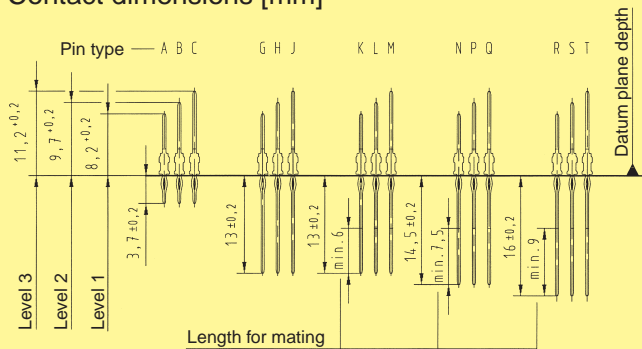

Board drillings

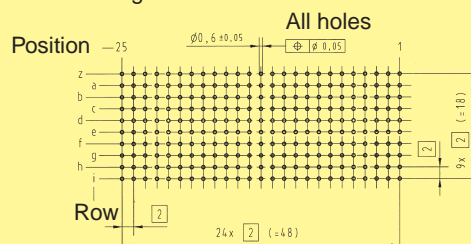

Dimensions [mm]

Thin printed part numbers: performance level 1  
**Bold printed part numbers: performance level 2**

harbus<sup>®</sup> HM the 2.0mm hard metric system from HARTING

CompactPCI<sup>®</sup> configuration

CompactPCI<sup>®</sup> as a standard is maintained and enhanced by the PCI Industrial Computer Manufacturers Group (PICMG<sup>®</sup>). It defines a combination of the electrical and logical specifications of the PCI standard and the mechanical specifications of the IEEE 1101 and IEC 60297 series of standards. The board connector has been developed from the IEC 61076-4-101 series of 2.0 mm connectors. The mounting location and dimensions for the 2.0 mm connectors are specified in IEEE 1101.11. Some additional mechanical definitions for 2.0 mm connectors in the Eurocard format are being specified in the VITA 30 draft. Other international standards are listed in the CompactPCI<sup>®</sup> standard for environmental and related specifications. This gives CompactPCI<sup>®</sup> a solid foundation of international standards and practices for mechanical robustness.

and J2/P2 as a minimum. Backplanes should always have the full complement of connectors to be compatible with any type of board.

Connectors, as well as contact numbers on the connectors are both numbered from bottom to top. This is opposite to numbering schemes in other architectures.

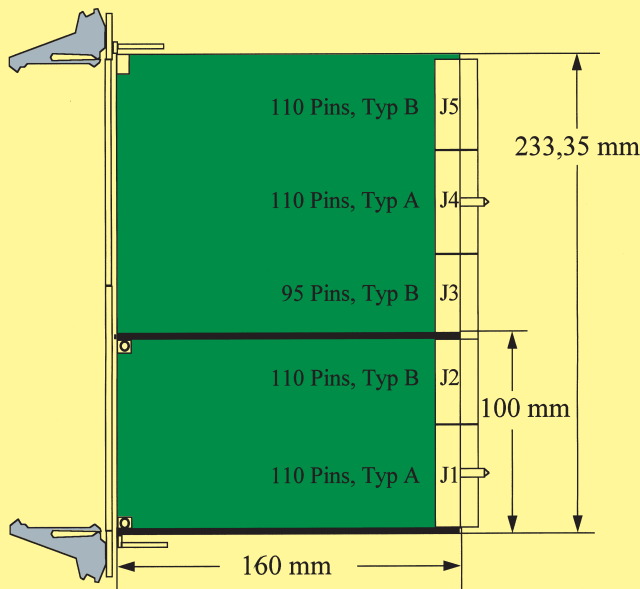
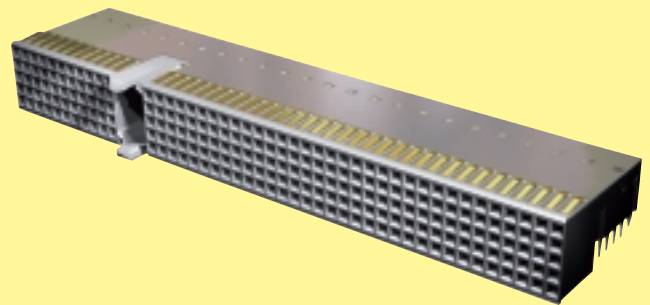

The front panel of CPCI cards may be equipped with additional keying pegs to code individual board types. There is also an extended length pin to remove any electro-static charge before the contacts on the rear connectors mate. This pin also functions as a mechanical guide to position the board as straight as possible for insertion. This prevents pin bending and lowers the insertion force. There might be more than 500 pins to be pushed into sockets, all at the same time.

Connectors for high availability applications (hot swap) come with 3 different lengths of pins for a staged sequence of make or break of contact.

The board format is either a 3U or a 6U Eurocard as defined in IEC 60297. There are two or five connectors specified for 3U or 6U boards respectively. Connectors are numbered from J1/P1 through J5/P5 (bottom to top) on the board or backplane. Slave or peripheral boards need J1/P1 as a minimum, master or system boards need both J1/P1

Connector J1/P1 carries the signals for a 32 bit PCI bus (see table of contact assignments for J1/P1). Connector J2/P2 on a system card has the additional signals for a 64 bit PCI bus and some user-defined I/O (see table of contact assignments for J2/P2). On slave cards all of J2/P2 might be user-defined I/O except the top row which carries the signals for geographical addressing. J3 should be reserved for other system bus definitions. J4/P4 and

harbus<sup>®</sup> HM the 2.0mm hard metric system from HARTING

Contact assignment on CompactPCI system slot (J1/P1)

	a	b	c	d	e	
25	+5 V	REQ64#	ENUM#	+3,3 V	+5 V	25
24	AD[1]	+5 V	V(I/O)	AD[0]	ACK64#	24
23	+3,3 V	AD[4]	AD[3]	+5 V	AD[2]	23
22	AD[7]	GND	+3,3 V	AD[6]	AD[5]	22
21	+3,3 V	AD[9]	AD[8]	M66EN	C/BE[0]#	21
20	AD[12]	GND	V(I/O)	AD[11]	AD[10]	20
19	+3,3 V	AD[15]	AD[14]	GND	AD[13]	19
18	SERR#	GND	+3,3 V	PAR	C/BE[1]#	18
17	+3,3 V	SDONE	SBO#	GND	PERR#	17
16	DEVSEL#	GND	V(I/O)	STOP#	LOCK#	16
15	+3,3 V	FRAME#	IRDY#	GND	TRDY#	15
14						14
13	Key Area					13
12						12
11	AD[18]	AD[17]	AD[16]	GND	C/BE[2]#	11
10	AD[21]	GND	+3,3 V	AD[20]	AD[19]	10
9	C/BE[3]#	IDSEL	AD[23]	GND	AD[22]	9
8	AD[26]	GND	V(I/O)	AD[25]	AD[24]	8
7	AD[30]	AD[29]	AD[28]	GND	AD[27]	7
6	REQ#	GND	+3,3 V	CLK	AD[31]	6
5	Bus Reserved	Bus Reserved	RST#	GND	GNT#	5
4	Bus Reserved	GND	V(I/O)	INTP	INTS	4
3	INTA#	INTB#	INTC#	+5 V	INTD#	3
2	TCK	+5 V	TMS	TDO	TDI	2
1	+5 V	-12 V	TRST#	+12 V	+5 V	1
	a	b	c	d	e	

Contact assignment on CompactPCI system slot (J2/P2)

	a	b	c	d	e	
22	GA4	GA3	GA2	GA1	GA0	22
21	CLK6	GND	Reserved	Reserved	Reserved	21
20	CLK5	GND	Reserved	GND	Reserved	20
19	GND	GND	Reserved	Reserved	Reserved	19
18	Bus Reserved	Bus Reserved	Bus Reserved	GND	Bus Reserved	18
17	Bus Reserved	GND	PRST#	REQ6#	GNT6#	17
16	Bus Reserved	Bus Reserved	DEG#	GND	Bus Reserved	16
15	Bus Reserved	GND	FAL#	REQ5#	GNT5#	15
14	AD[35]	AD[34]	AD[33]	GND	AD[32]	14
13	AD[38]	GND	V(I/O)	AD[37]	AD[36]	13
12	AD[42]	AD[41]	AD[40]	GND	AD[39]	12
11	AD[45]	GND	V(I/O)	AD[44]	AD[43]	11
10	AD[49]	AD[48]	AD[47]	GND	AD[46]	10
9	AD[52]	GND	V(I/O)	AD[51]	AD[50]	9
8	AD[56]	AD[55]	AD[54]	GND	AD[53]	8
7	AD[59]	GND	V(I/O)	AD[58]	AD[57]	7
6	AD[63]	AD[62]	AD[61]	GND	AD[60]	6
5	C/BE[5]#	GND	V(I/O)	C/BE[4]#	PAR64	5
4	V(I/O)	Bus Reserved	C/BE[7]#	GND	C/BE[6]#	4
3	CLK4	GND	GNT3#	REQ4#	GNT4#	3
2	CLK2	CLK3	SYSEN#	GNT2#	REQ3#	2
1	CLK1	GND	REQ1#	GNT1#	REQ2#	1
	a	b	c	d	e	

J5/P5 are used for I/O or secondary buses, e.g. H.110 in telecom applications or for bridges into other buses like VMEbus. This is used to accommodate two bus platforms in one card cage on one backplane.

In mechanical terms J1/P1 is a 25 x 5 matrix of contacts. Three rows of 5 contacts (rows 12 - 15) are not used for electrical contacts. Instead, plastic keys of different orientation and configuration are used to key board locations as to system or peripheral slot, voltage options, etc. J2/P2 is a shortened connector with only 22 rows of contacts instead of 25 rows for a standard size. HARTING now offers monolithic versions with J1/P1 and J2/P2 combined in one single connector. This combination together with some space left on the card to fit into guide rails makes maximum use of the 100 mm rear edge of the 3U Eurocard. On a 6U card this connector setup is repeated on J4/P4 and J5/P5. The J3/P3 connector is a shortened version of the 2.0 mm connector with 19 rows of 5 signal contacts. The size results from

the height of a 6U board (233 mm) which is more than double the height of a 3U board.

All connectors used for CompactPCI<sup>®</sup> are based on a 7 column pitch. The inner 5 columns are used for logic signals and power. The outer columns on either side are reserved for shielding or ground.



Executive Member



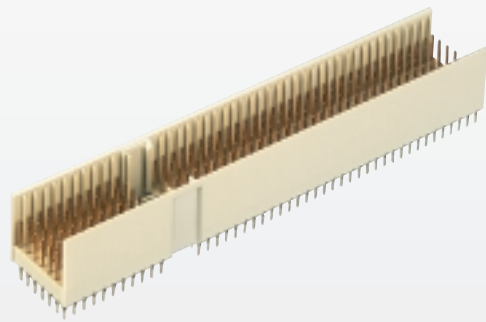

Type Monoblock 47  
Male connectors, straight

Identification	Number of contacts	Contact length [mm] mating side	termination side	Part number	Contact configuration
Type Monoblock 47	220	8.2	3.7	17 06 220 1201 <b>17 06 220 2201</b>	
Type Monoblock 47	308	8.2/ 11.2	3.7	17 06 308 1201 <b>17 06 308 2201</b>	
Type Monoblock 47	220	9.7	3.7	17 06 220 1202 <b>17 06 220 2202</b>	
Type Monoblock 47	308	9.7/ 11.2	3.7	17 06 308 1204 <b>17 06 308 2204</b>	

Contact dimensions [mm]

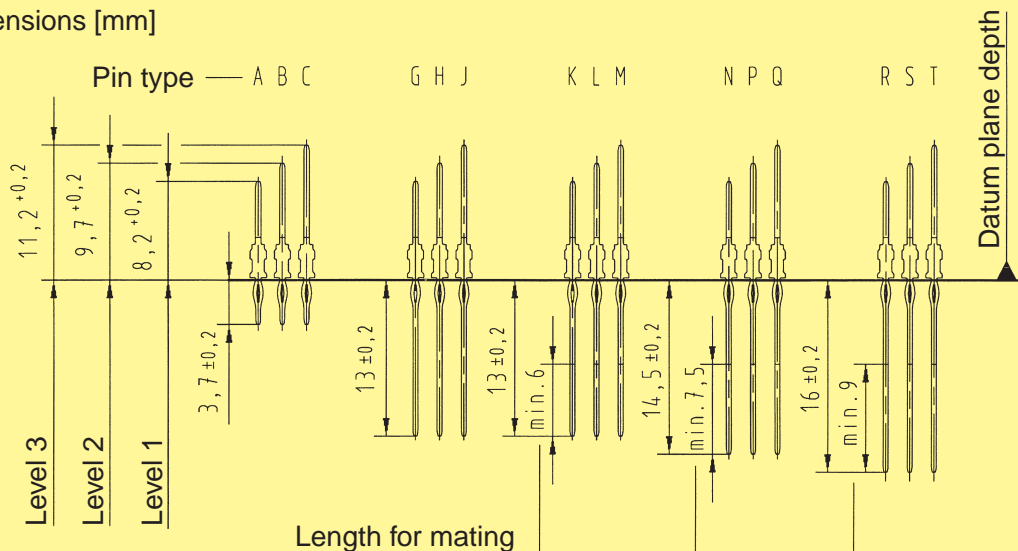

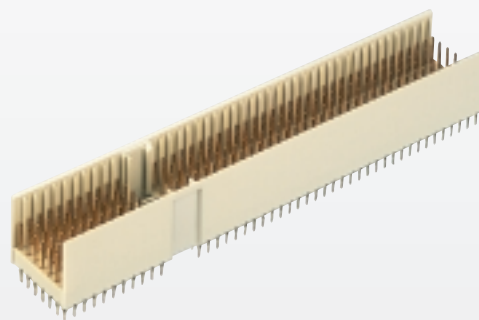

Type Monoblock 47  
Male connectors, straight

Identification	Number of contacts	Contact length [mm] mating side	termination side	Part number	Contact configuration
Type Monoblock 47 CompactPCI	308	8.2/ 9.7/ 11.2	3.7	17 06 308 1202 <b>17 06 308 2202</b>	
Type Monoblock 47 CompactPCI hot swap	308	8.2/ 9.7/ 11.2	3.7	17 06 308 1203 <b>17 06 308 2203</b>	
Type Monoblock 47 CompactPCI computer telephony	232	8.2/ 9.7/ 11.2	3.7	17 06 232 1201 <b>17 06 232 2201</b>	
Type Monoblock 47 CompactPCI I/O	308	8.2/ 9.7/ 11.2	3.7/ 16.0	17 06 308 1001 <b>17 06 308 2001</b>	

Contact dimensions [mm]

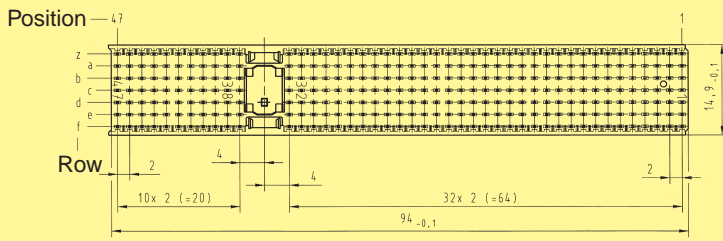
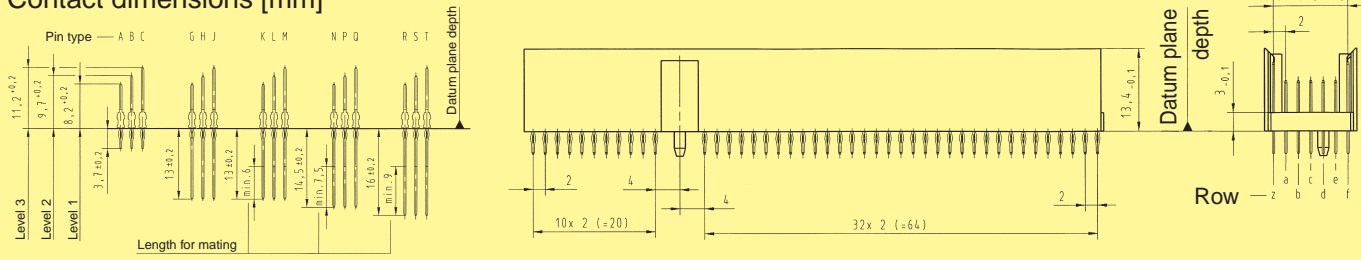

Board drillings

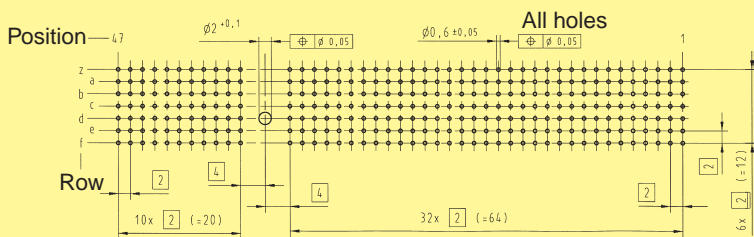

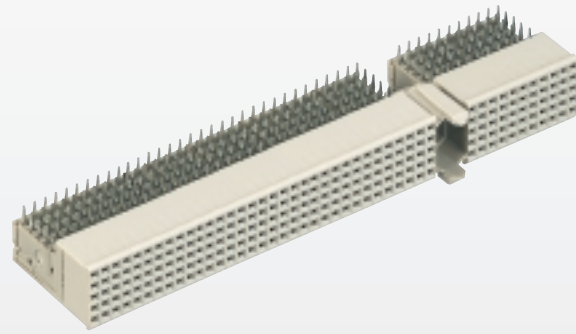

Type Monoblock 47  
Female connectors, angled

Identification	No. of contacts	Contact length [mm]		Part number
			termination side	
Type Monoblock 47	220		3.4	17 26 220 1101 <b>17 26 220 2101</b>
Type Monoblock 47, with pre-installed upper shield	220		3.4	17 26 220 1102 <b>17 26 220 2102</b>
Type Monoblock 47, with pre-installed upper shield, CompactPCI computer telephony	200		3.4	17 26 200 1103 <b>17 26 200 2103</b>
Lower shield for type Monoblock 47 connectors				17 26 000 4102
Lower shield for type Monoblock 47 connectors (rows 1 – 22), CompactPCI computer telephony				17 24 000 4102
Lower shield for type Monoblock 47 connectors (rows 23 – 27), CompactPCI computer telephony				17 29 000 4102
Lower shield for type Monoblock 47 connectors (rows 37 – 47), CompactPCI computer telephony				17 23 000 4102

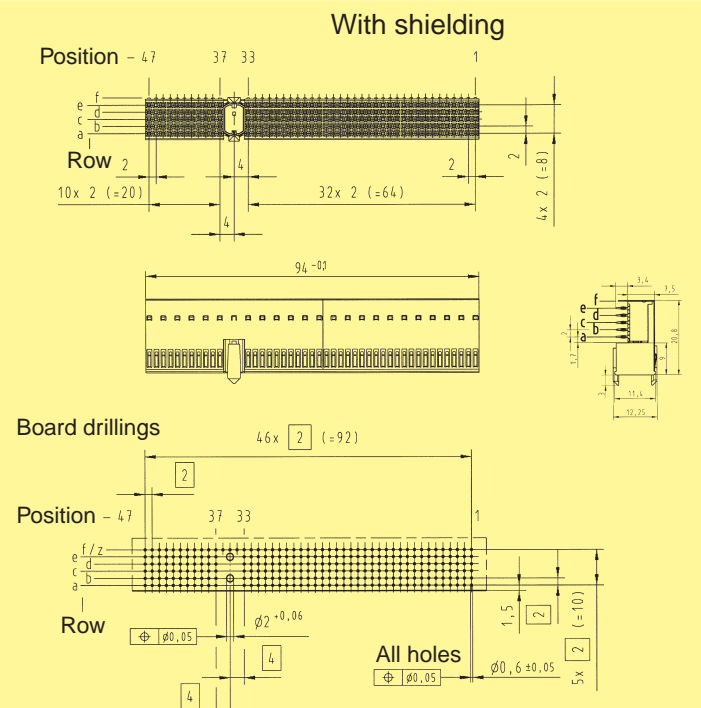
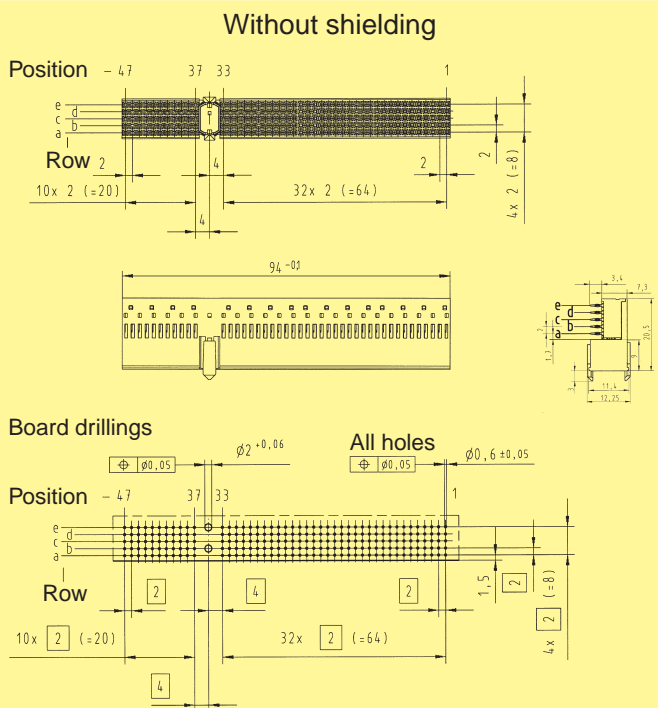

Dimensions [mm]

## Coding

Coding keys are used to prevent mismating of boards. They can be inserted into the multifunctional area of male and female connectors with a special tooling. This can be easily done after the connectors have been pressed in. To identify coding keys very simply they have different bright and pre-defined RAL colours. In the table below all colours and code numbers in acc. to the IEC 61076-4-101 are listed. The bold printed part numbers are preferred types that will be used for the following applications:

- Cadmium yellow for CompactPCI to identify 3.3 V bus signalling
- Brilliant blue for CompactPCI to identify 5 V bus signalling
- Reseda green to prevent accidental board insertion in VME64x on CompactPCI applications
- Strawberry red to prevent accidental board insertion in telephony applications

### Coding keys for male connectors

Coding key	Code number	Colour	Part number
	3568	Pastel orange RAL 2003	17 79 000 0010
	3478	Steel blue RAL 5011	17 79 000 0011
	3467	Slate grey RAL 7015	17 79 000 0012
	3456	Cadmium yellow RAL 1021 for CPCI, 3.3 V	<b>17 79 000 0013</b>
	2578	Reseda green RAL 6011	<b>17 79 000 0014</b>
	1567	Brilliant blue RAL 5007 for CPCI, 5.0 V	<b>17 79 000 0015</b>
	1356	Blue lilac RAL 4005	17 79 000 0016
	4678	Ocher yellow RAL 1024	17 79 000 0017
	1248	Strawberry red RAL 3018	<b>17 79 000 0018</b>
	1236	Nut brown RAL 8011	17 79 000 0019

### Coding keys for female connectors

Coding key	Code number	Colour	Part number
	1247	Pastel orange RAL 2003	17 79 000 0020
	1256	Steel blue RAL 5011	17 79 000 0021
	1258	Slate grey RAL 7015	17 79 000 0022
	1278	Cadmium yellow RAL 1021 for CPCI, 3.3 V	<b>17 79 000 0023</b>
	1346	Reseda green RAL 6011	<b>17 79 000 0024</b>
	2348	Brilliant blue RAL 5007 for CPCI, 5.0 V	<b>17 79 000 0025</b>
	2478	Blue lilac RAL 4005	17 79 000 0026
	1235	Ocher yellow RAL 1024	17 79 000 0027
	3567	Strawberry red RAL 3018	<b>17 79 000 0028</b>
	4578	Nut brown RAL 8011	17 79 000 0029

harbus<sup>®</sup> HM the 2.0mm hard metric system from HARTING

VME64x configuration

The VMEbus has evolved over a period of more than 15 years to become the leading bus architecture in open industrial applications. The specification is an ANSI norm the original specification has been extended to become a draft standard VME64x ANSI/VITA 1.1-1997. This draft standard includes the specification for the new 5-row DIN compatible connector (IEC 61076-4-113) and for a center connector J0/P0 on 6U VME cards, which is identical to J3/P3 in CompactPCI<sup>®</sup> systems.

In VMEbus systems it is possible to use custom connectors in the J0/P0 area (e.g. coax connectors). To prevent problems with non-mating backplanes it is strongly recommended to use front panel keying. The IEEE 1101 documents J0/P0 can also be used with rear transition modules for pluggable I/O cabling. As mentioned above the contacts on this connector may be bussed. One example is the ATM CellBus, which is in the process of being standardised. The bus on J0/P0 connectors might actually be a plug-on mezzanine backplane rather than conducting traces integrated into the backplane itself.

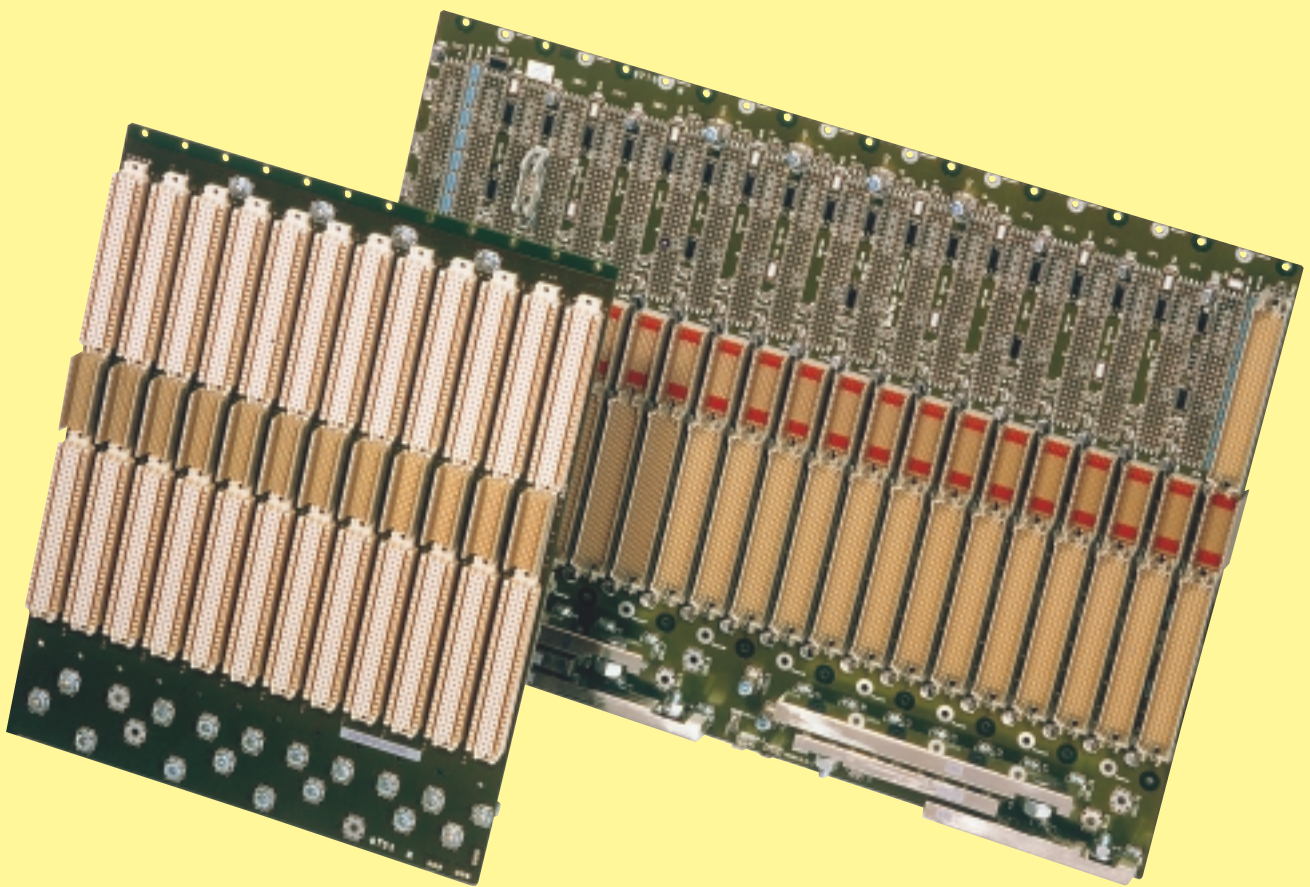

The 2.0 mm J0/P0 connector in VME64x systems is used for additional I/O, for new high speed sub busses or I/O for mezzanine modules, e.g. IP modules on VMEbus boards. The connector is placed on the Eurocard to work in combination with the non-metric original VMEbus connectors or the newer 5-row connector. The mounting location and dimensions for the J0/P0 VMEbus connector (IEC 61076-4-101) is specified in IEEE 1101.11. The VMEbus 2.0 mm connector uses 5 columns of signal contacts and as an optional has an additional outer column on either side for shielding. All 95 signal contacts are user defined.



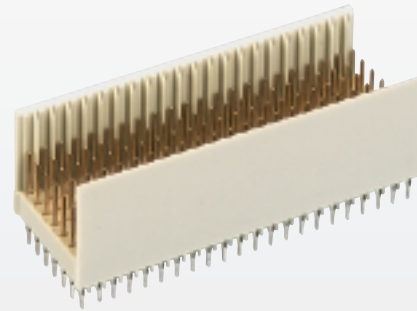

Type B  
Male connectors, straight

Identification	Number of contacts	Contact length [mm] mating side	termination side	Part number	Contact configuration
Type B VME J0	133	9.7/ 11.2	3.7	17 05 133 1203 <b>17 05 133 2203</b>	
Type B VME J0	95	8.2	13.0	17 05 095 1401 <b>17 05 095 2401</b>	
Type B VME J0	95	8.2	3.7	17 05 095 1201 <b>17 05 095 2201</b>	
Type B VME J0	133	8.2/ 11.2	3.7	17 05 133 1201 <b>17 05 133 2201</b>	

Contact dimensions [mm]

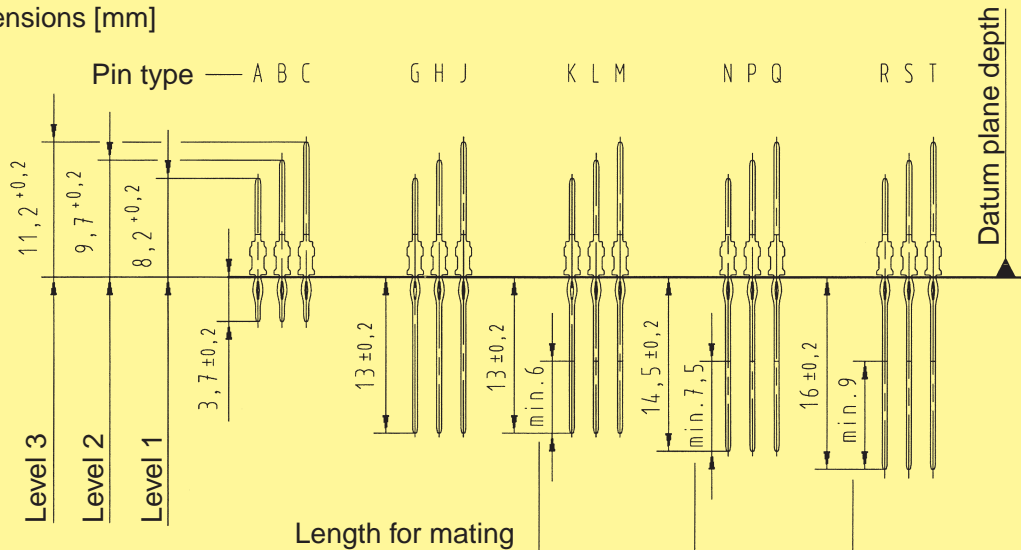

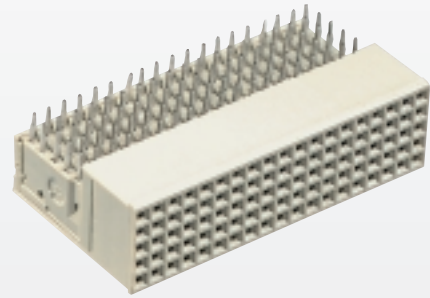

Type B  
Female connectors, angled

Identification	No. of contacts	Contact length [mm] termination side	Part number
Type B VME P0	95	3.4	17 25 095 1101 <b>17 25 095 2101</b>
Type B, VME P0 with pre-installed upper shield	95	3.4	17 25 095 1102 <b>17 25 095 2102</b>

Contact positions	x <sub>1</sub>	x <sub>2</sub>
19	37.9	18 x <b>2</b> (= 36)

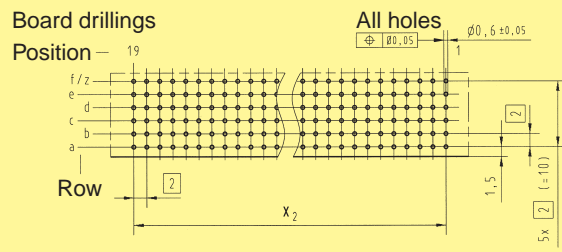
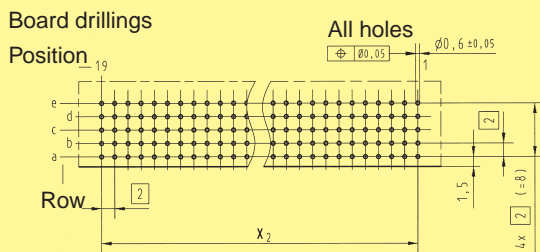
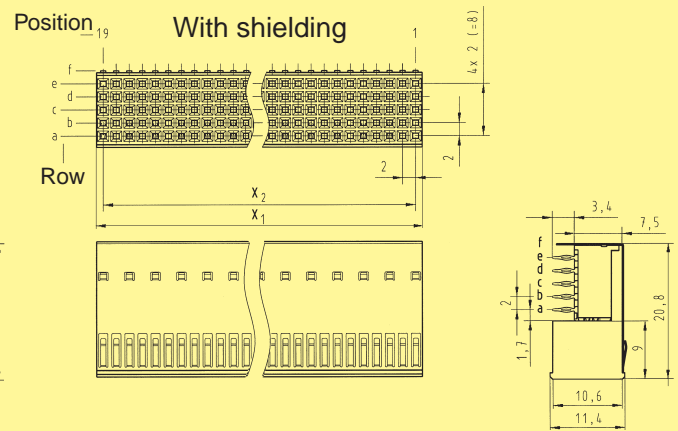
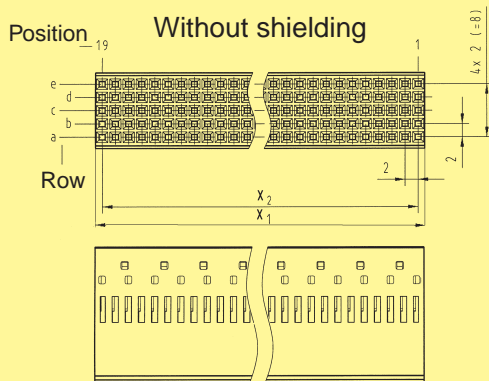

## Tooling

### Press-in Tools



**C.P.M. 2001/s:**  
Semi-automatic for applications up to: 100 kN



**C.P.M. 2001/a:**  
The most advanced high speed assembling machine.

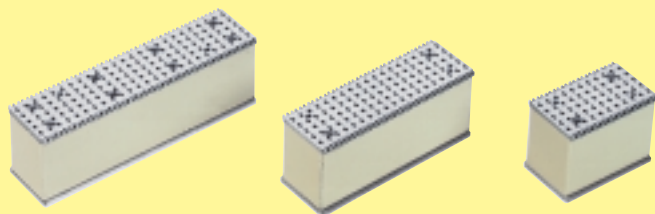

To press in the har-bus® HM connector, an insert block is used (see the pictures on the left). This block can be put into the connector manually or automatically. To start the press in process, the operator pushes a flat die on the insert block. The ease of this method reduces cost because no special tools are necessary.

The insert block 17 99 000 0001 e.g. can be used for the types A, C and Monoblock 47.

Part number connector	Quantity and part number insert block
17 01 xxx xxxx, type A	1 x 17 99 000 0009 or 2 x 17 99 000 0001
17 04 xxx xxxx, type B	1 x 17 99 000 0004
17 05 xxx xxxx, type B	1 x 17 99 000 0002
17 02 xxx xxxx, type B	1 x 17 99 000 0003
17 03 xxx xxxx, type C	1 x 17 99 000 0001
17 06 xxx xxxx, type Monoblock 47	1 x 17 99 000 0008 or 1 x 17 99 000 0001 and 1 x 17 99 000 0005
17 11 xxx xxxx, type D	1 x 17 99 000 0006
17 12 xxx xxxx, type E	1 x 17 99 000 0007



# HARTING customer request form

If you need a specially loaded connector for your application please use this request form. Fill out the drawing for the desired connector style and mark each position with the required contact length (A, B, ..., S, T).

## Type A

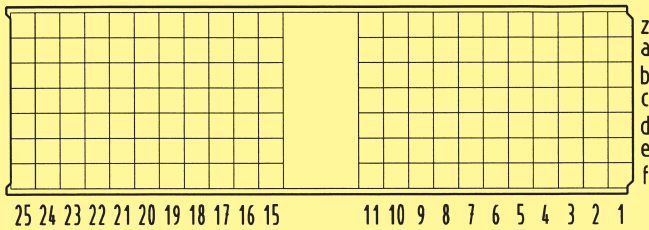

## Contact dimensions [mm]

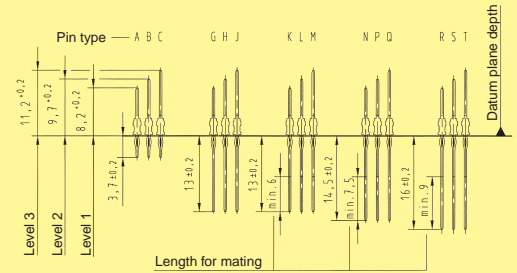

## Type B (19, 22 or 25 positions)

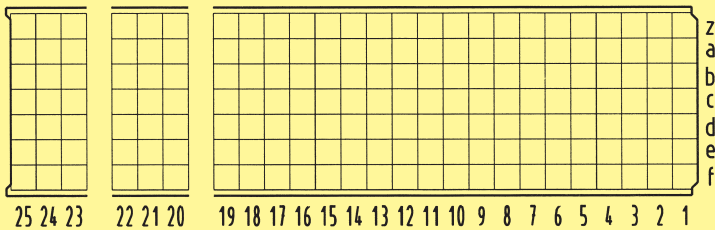

## Type C

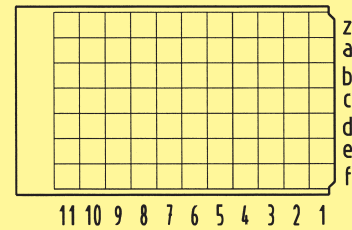

## Type Monoblock 47

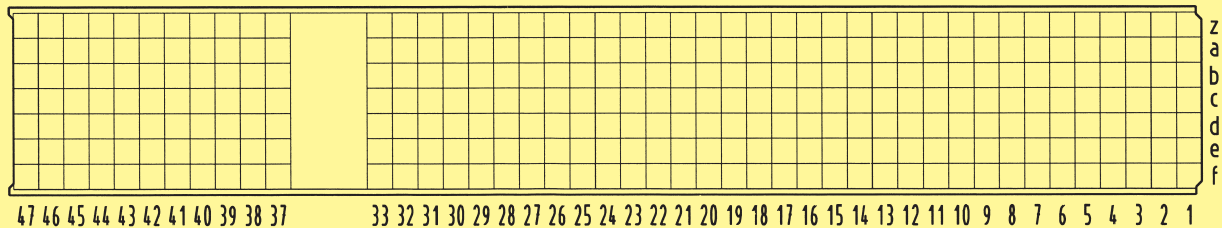

Name: \_\_\_\_\_

Performance level:  1  2

Company: \_\_\_\_\_

Drawing:  yes  no

Address: \_\_\_\_\_

Samples:  no  yes, quantity

\_\_\_\_\_

Volume (pcs./year): \_\_\_\_\_

Phone: \_\_\_\_\_

\_\_\_\_\_

Fax: \_\_\_\_\_

Special requirements: \_\_\_\_\_

E-Mail: \_\_\_\_\_

\_\_\_\_\_

Part number	Page	Part number	Page	Part number	Page	Part number	Page
17 01 100 1001	11	17 04 154 1201	14	17 12 200 1201	22	17 25 095 2102	17
17 01 100 1201	11	17 04 154 1203	14	17 12 200 2201	22	17 25 095 2102	31
17 01 100 2001	11	17 04 154 1204	14				
17 01 100 2201	11	17 04 154 1601	15				
		17 04 154 2201	14	17 12 250 1001	22		
17 01 110 1201	9	17 04 154 2203	14	17 12 250 1201	22		
17 01 110 1204	9	17 04 154 2204	14	17 12 250 2001	22	17 26 000 4102	27
17 01 110 1402	10	17 04 154 2601	15	17 12 250 2201	22		
17 01 110 2201	9						
17 01 110 2204	9	17 05 095 1201	15	17 21 000 4102	12	17 26 200 1103	27
17 01 110 2402	10	17 05 095 1201	30			17 26 200 2103	27
		17 05 095 1401	16	17 21 090 1103	12		
17 01 154 1001	10	17 05 095 1401	30	17 21 090 2103	12		
17 01 154 1201	9	17 05 095 2201	15			17 26 220 1101	27
17 01 154 1203	10	17 05 095 2201	30			17 26 220 1102	27
17 01 154 1204	10	17 05 095 2401	16	17 21 110 1101	12		
17 01 154 1205	9	17 05 095 2401	30	17 21 110 1102	12	17 26 220 2101	27
17 01 154 2001	10			17 21 110 2101	12	17 26 220 2102	27
17 01 154 2201	9	17 05 133 1201	15	17 21 110 2102	12		
17 01 154 2203	10	17 05 133 1201	30				
17 01 154 2204	10	17 05 133 1203	16				
17 01 154 2205	9	17 05 133 1203	30	17 22 000 4102	17		
		17 05 133 2201	15			17 29 000 4102	12
17 02 125 1201	13	17 05 133 2201	30	17 22 125 1101	17	17 29 000 4102	27
17 02 125 2201	13	17 05 133 2203	16	17 22 125 1102	17		
		17 05 133 2203	30	17 22 125 2101	17		
				17 22 125 2102	17		
17 02 175 1201	13					17 79 000 0010	28
17 02 175 1202	13	17 06 220 1201	25			17 79 000 0011	28
17 02 175 2201	13	17 06 220 1202	25	17 23 000 4102	12	17 79 000 0012	28
17 02 175 2202	13	17 06 220 2201	25	17 23 000 4102	20	17 79 000 0013	28
		17 06 220 2202	25	17 23 000 4102	27	17 79 000 0014	28
						17 79 000 0015	28
17 03 055 1201	18	17 06 232 1201	26	17 23 055 1101	20	17 79 000 0016	28
17 03 055 1202	18	17 06 232 2201	26	17 23 055 1102	20	17 79 000 0017	28
17 03 055 1401	19			17 23 055 2101	20	17 79 000 0018	28
17 03 055 2201	18	17 06 308 1001	26	17 23 055 2102	20	17 79 000 0019	28
17 03 055 2202	18	17 06 308 1201	25			17 79 000 0020	28
17 03 055 2401	19	17 06 308 1202	26	17 24 000 4102	17	17 79 000 0021	28
		17 06 308 1203	26	17 24 000 4102	27	17 79 000 0022	28
17 03 077 1001	19	17 06 308 1204	25			17 79 000 0023	28
17 03 077 1201	18	17 06 308 2001	26			17 79 000 0024	28
17 03 077 1202	18	17 06 308 2201	25	17 24 110 1101	17	17 79 000 0025	28
17 03 077 2001	19	17 06 308 2202	26	17 24 110 1102	17	17 79 000 0026	28
17 03 077 2201	18	17 06 308 2203	26	17 24 110 2101	17	17 79 000 0027	28
17 03 077 2202	18	17 06 308 2204	25	17 24 110 2102	17	17 79 000 0028	28
						17 79 000 0029	28
17 04 110 1201	13	17 11 176 1201	21	17 25 000 4102	17	17 99 000 0001	32
17 04 110 2201	13	17 11 176 2201	21			17 99 000 0002	32
				17 25 095 1101	17	17 99 000 0003	32
17 04 132 1001	14	17 11 220 1001	21	17 25 095 1101	31	17 99 000 0004	32
17 04 132 1201	15	17 11 220 1201	21	17 25 095 1102	17	17 99 000 0005	32
17 04 132 2001	14	17 11 220 2001	21	17 25 095 1102	31	17 99 000 0006	32
17 04 132 2201	15	17 11 220 2201	21	17 25 095 2101	17	17 99 000 0007	32
				17 25 095 2101	31	17 99 000 0008	32
						17 99 000 0009	32

## HARTING – Subsidiary companies

### Austria

HARTING Ges. m. b. H.  
Deutschstraße 3, A-1230 Wien  
Tel. +43 1/6 16 21 21  
Fax +43 1/6 16 21 21-21  
E-Mail: at@HARTING.com

### Belgium

N.V. HARTING S.A.  
Doornveld 8, B-1731 Zellik  
Tel. +32 2/4 66 01 90, Fax +32 2/4 66 78 55  
E-Mail: be@HARTING.com

### Brazil

HARTING Ltda.  
Av. Dr. Lino de Moraes Leme  
255 - ZIP Code 04360-001 - São Paulo - Brazil  
Tel. (0 11) 5 36 00 73, Fax (0 11) 5 33 47 43  
E-Mail: br@HARTING.com

### China

HARTING (HK) Limited  
Shanghai Representative Office  
Room 2302, Hong Kong Plaza South Tower  
283 Huai Hai Road (M),  
Shanghai 200021, China  
Tel. +86 (21)/63 90 69 35  
Fax +86 (21)/63 90 69 99  
E-Mail: HARTING@public.shanghai.cngb.com

### Czech Republic

HARTING spol. s.r.o.  
Jankovcova 2, 17088 Praha 7  
Tel. +4 20 / 2 66 78 41 52  
Fax +4 20 / 2 66 78 41 59  
E-Mail: HARTING@HARTING.cz

### Finland

HARTING KGaA, Office Finland  
Malmin Kauppatie 8 A 3, FIN-00700 Helsinki  
Tel. +35 9 35 08 73 00, Fax +35 9 35 08 73 20  
E-Mail: fi@HARTING.com

### France

HARTING France  
ZAC Paris Nord II, 181, av. des Nations  
B.P. 60058  
F-95972 Roissy Charles de Gaulle Cedex  
Tel. +33(0)1 49 38 34 00  
Fax +33(0)1 48 63 23 06  
E-Mail: fr@HARTING.com

### Germany

HARTING Vertrieb für Steckverbinder  
und Systemtechnik GmbH & Co. KG  
Postfach 2451, D-32381 Minden  
Tel. +49 5 71 / 88 96 - 0  
Fax +49 5 71 / 88 96 - 282  
E-Mail: de.sales@HARTING.com

### Great Britain

HARTING Ltd.  
Caswell Road, Brackmills Industrial Estate  
GB-Northampton, NN4 7PW  
Tel. +44 16 04 / 76 66 86  
Fax +44 16 04 / 70 67 77  
E-Mail: gb@HARTING.com

### Hong Kong

HARTING (HK) Limited  
4208 Metroplaza Tower I, 223 Hing Fong Road  
Kwai Fong, N. T., Hong Kong  
Tel. +8 52 / 24 23 73 38, Fax +8 52 / 24 80 43 78  
E-Mail: harthk@iohk.com

### Italy

HARTING SpA  
Via Dell' Industria 7  
I-20090 Vimodrone (Milano)  
Tel. +39 02 / 25 08 01, Fax +39 02 / 2 65 05 97  
E-Mail: it@HARTING.com

### Japan

HARTING K. K.  
German Industry Center 407  
1-18-2, Hakusan  
Midori-ku, Yokohama  
226-0006, Japan  
Tel. +81 45 / 9 31-57 15, Fax +81 45 / 9 31-57 19  
E-Mail: HARTING@olive.ocn.ne.jp

### Korea

HARTING Korea Limited  
Room 103, Shinwon Plaza Building  
28-2 Hannam-Dong, Yongsan-Ku  
Seoul 140-210  
Tel. +82 (2) / 37 80 46 14  
Fax +82 (2) / 37 80 46 44  
E-Mail: hartkrhs@elim.net

### Netherlands

HARTING B.V.  
Larenweg 44, NL-5234 KA's-Hertogenbosch  
Postbus 3526, NL-5203 DM's-Hertogenbosch  
Tel. +31 73 / 6 41 04 04, Fax +31 73 / 6 44 06 99  
E-Mail: HARTING.netherlands@wxs.nl

### Norway

HARTING A/S  
Østensjøveien 36, N-0667 Oslo  
Tel. +47 22 / 64 75 90, Fax +47 22 / 64 73 93  
E-Mail: no@HARTING.com

### Russia

HARTING ZAO  
ul. Tobolskaja 12  
Saint Petersburg, 194044 Russia  
Tel. +7 / 8 12 / 3 27 64 77  
Fax +7 / 8 12 / 3 27 64 78  
E-Mail: HARTING@mail.wplus.net

### Singapore

HARTING Singapore Pte Ltd.  
25 International Business Park  
#04-05 German Centre  
Singapore 609916  
Tel. +65 5 62 / 81 90, Fax +65 5 62 / 81 99  
E-Mail: jklam@pd.jaring.my

### Spain

HARTING Elektronik S.A.  
Josep Tarradellas 20-30 3<sup>ra</sup>5<sup>a</sup>  
E-08029 Barcelona  
Tel. +34 93 / 3 63 84 84  
Fax +34 93 / 4 19 95 85  
E-Mail: es@HARTING.com

### Sweden

HARTING AB  
Fagerstagatan 18 A, 5 TR., S-16353 Spånga  
Tel. +46 8 / 4 45 71 71, Fax +46 8 / 4 45 71 70  
E-Mail: se@HARTING.com

### Switzerland

HARTING AG  
Industriestrasse 26, CH-8604 Volketswil  
Tel. +41 1 / 9 46 09 66, Fax +41 1 / 9 46 09 70  
E-Mail: ch.zh@HARTING.com

### Taiwan

HARTING R.O.C. Limited  
7<sup>th</sup> Floor, Fu Hsin Financial Building  
222, Fu Hsin S. Road, Sec. 1, Taipei  
Tel. +8 86 (2) / 87 73 85 77,  
Fax +8 86 (2) / 87 73 85 76  
E-Mail: hartwn@mky.com

### USA

HARTING Inc. of North America  
1370 Bowes Road, Elgin, IL 60123  
Tel. 8 47 / 7 41-15 00, Fax 8 47 / 7 41-82 61  
E-Mail: us@HARTING.com

### Eastern-Europe

HARTING Bauelemente GmbH  
Vertrieb Osteuropa  
Bamberger Straße 7, D-01187 Dresden  
Tel. +49 3 51 / 4 36 17 60  
Fax +49 3 51 / 4 36 17 70  
E-Mail: HARTING.dresden@t-online.de

### South-Eastern-Europe and other foreign countries

HARTING KGaA  
P.O. Box 1133, D-32325 Espelkamp  
Tel. +49 5 77 2 / 47-0  
Fax +49 5 77 2 / 47-4 62 / - 4 95  
E-Mail: de.sales@HARTING.com

## Foreign representatives

### Australia

### Denmark

Knud Wexøe A/S  
Skaettekøer 11, P.O. Box 152  
DK-2840 Holte  
Tel. +45 45 46 58 00, Fax +45 45 46 58 01  
E-Mail: wexoe@wexoe.dk

### India

Sahajanand Impex Pvt. Ltd.  
Acharya Donde Marg, Opp. Thakre Udyan  
Sewree, Mumbai, 400015  
Tel. +91 22 / 4 13 51 51  
Fax +91 22 / 4 14 78 20  
E-Mail: sahanand@vsnh.com

### Portugal

UNIMAQUE  
ELÉTRONICA E ELECTRICIDADE  
INDUSTRIAL, LDA.  
Rua Augusto Gil, 22-B, P-1000 Lisboa  
Tel. +35 11 / 7 96 67 32 / 85  
Fax +35 11 / 7 96 09 24

### South-Africa

Bowthorpe Hellermann (Pty) Ltd.  
P. O. Box 27063, ZA-2011 Johannesburg TVL  
Tel. +27 11 / 6 16-19 60  
Fax +27 11 / 6 16-47 15

### South-Africa

Allcable (Pty) Ltd.  
P.O. Box 13518, Witfield 1467, R. S. A.  
Tel. +27 11 / 8 45 33 25, Fax  
+27 11 / 8 45 40 77

## Production plants

Espelkamp, Germany, plant 1–4  
Northampton, Great Britain  
Biel, Switzerland  
Chicago, USA  
China

## World Headquarters

HARTING KGaA  
P.O. Box 1133 · D-32325 Espelkamp  
Tel. +49 5 77 2 / 47-0  
Fax +49 5 77 2 / 47-4 62 / - 4 95  
E-Mail: de.sales@HARTING.com  
Internet: <http://www.HARTING.com>



**HARTING KGaA**

Marienwerderstraße 3 · D-32339 Espelkamp  
P.O. Box 11 33 · D-32325 Espelkamp  
☎ +49 57 72/47-0 · Fax +49 57 72/47-4 62  
E-Mail: [de.pbc@HARTING.com](mailto:de.pbc@HARTING.com)  
Internet: <http://www.HARTING.com>