

# Power Relay G2A

## Highly Reliable, 4-pole Miniature Relay Ideal for Sequence Control

- Card lift-off employed for greater life and stable quality.
- Long endurance and stable quality are assured by card lift-off system.
- Mounting interchangeability with MY-series Relays.
- Operation indicator mechanism incorporated for at-a-glance monitoring of ON/OFF operation. In addition, a built-in operation indicator model is also included in this Relay Series.

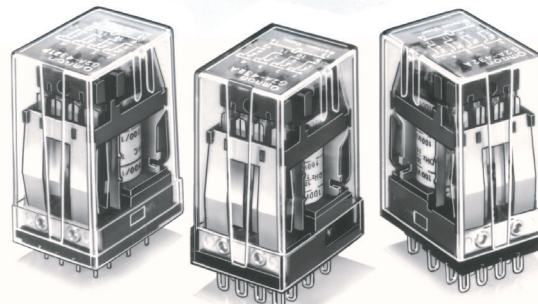

## Ordering Information

Classification		Plug-in terminals/Solder terminals	PCB terminals
Standard model		G2A-432A	G2A-4321P
Arc barrier equipped model		G2A-432AY	---
Built-in diode model		G2A-432A-D	G2A-4321P-D
Built-in operation indicator model		G2A-432A-N	---
Built-in operation indicator and diode model		G2A-432A-N1	---
UL-approved model	Standard model	G2A-432A-US	G2A-4321P-US
	Arc barrier equipped model	G2A-432AY-US	---

- Note:** 1. When placing your order, add the coil voltage rating listed in the specifications to the model number as shown below.  
 Example: G2A-432A 100/110 VAC  
Rated coil voltage
2. Built-in diode model and the operating coil of the G2A-432A-N1 are available only with DC ratings.
3. The Latching Relay (G2AK) and Fully sealed Relay (G2A-434A) developed based on the G2A are also available in this series.

## Model Number Legend

G2A-□□□□□-□  
1 2 3 4 5 6

### 1. Number of Poles and Contact Form

4: 4PDT

### 2. Contact Type

3: Crossbar bifurcated

### 3. Enclosure Construction

2: Casing

### 4. Terminal Shape

A: Plug-in

1P: PCB

### 5. Safety Breaking Mechanism

None: No

Y: Arc barrier

### 6. Special Element

None: Standard

D: Built-in diode

N: Built-in operation indicator

N1: Built-in operation indicator and diode

US: UL-approved

- Note:** 1. The coil of the G2A-432A-N1 or a built-in diode model operates with DC only.
2. The G2A Series include the G2A-434A Power Relay and G2AK Latching Relay. Refer to page 133 for details.
3. Built-in indicator models satisfying international standards are available. Contact your OMRON representative for details.

## ■ Relays Other than Standard Models

Arc barrier equipped	Built-in diode	Built-in operation indicator
G2A-432AY	G2A-432A-D	G2A-432A-N
The arc barrier equipped model is a relay designed to prevent arc short-circuiting between phases and can be used in a circuit which has potential difference between phases. The switching power of such a circuit with potential difference must be limited to less than 1/2 the rated load when using this Relay.	The built-in diode model is a relay which incorporates a diode for absorption of the reverse voltage that may be generated when the coil is de-energized. Because the release time of this model is longer than the standard model, pay adequate attention to this point in designing a circuit. Also, pay attention to the + polarity of the coil. The reverse-breakdown voltage of the diode is 1,000 V.	The built-in operation indicator model has a newly added operation indicator to the conventional operation indication mechanism and facilitates operation monitoring without being affected by ambient illumination. With the -N model (rated at 16, 12, 24, and 48 VDC) and -N1 model rated at 6, 12, 24, 48, and 100 VDC), pay attention to the + polarity of the coil.

## ■ Accessories

### Sockets

Track mounting Screw terminals	Front-connecting Socket	Solder terminals				Wire-wrap terminals		PCB terminals
		Without Hold-down Clip		With Hold-down Clip		Without Hold-down Clip	With Hold-down Clip	
		Without Hold-down Clip	With Hold-down Clip	Without Hold-down Clip	With Hold-down Clip			
PYF14A	PYF14(-E), PYF14A-TU, PYF14T	PY14, PY14-3 (see note)	PY14-Y2	PY14QN(2)	PY14QN(2)-Y2	PY14-0, PY14-02		

Note: With monitor terminal.

### Relay Hold-down Clips

For Front-connecting Socket	PYC-A2
For Back-connecting Socket	PYC-3/PYC-5
For Socket Mounting Plate	PYC-2

### Socket Mounting Plates

For one Socket	PYP-1
For 18 Sockets	PYP-18
For 36 Sockets	PYP-38

## Specifications

### ■ Coil Ratings

The rated currents for some of the built-in operation indicator models differ from the values given in this table. Refer to note 5 below.

Rated voltage	Rated current		Coil resistance	Coil inductance (ref. value)		Must operate	Must release	Max. voltage	Power consumption
	50 Hz	60 Hz		Armature OFF	Armature ON				
6 VAC	295 mA	233 mA	8.9 Ω	0.048 H	0.065 H	80 % max.	30 % min.	110 %	Approx. 1.4 VA
12 VAC	148 mA	117 mA	34 Ω	0.166 H	0.257 H				
24 VAC	73 mA	58 mA	136 Ω	0.691 H	1.04 H				
50 VAC	35 mA	28 mA	530 Ω	3.08 H	4.53 H				
100/ 110 VAC	17.7/ 21.4 mA	14/ 16.8 mA	2,200 Ω	12.42/ 12.38 H	18/16.4 H				
200/ 220 VAC	8.9/ 10.8 mA	7/8.4 mA	8,800 Ω	42.2/ 41.8 H	72/65.5 H	10 % min.	110 %	Approx. 1.1 W	
6 VDC	176 mA		34 Ω	0.14 H	0.26 H				
12 VDC	88 mA		136 Ω	0.6 H	1.0 H				
24 VDC	45 mA		530 Ω	2.7 H	4.6 H				
48 VDC	22 mA		2,200 Ω	11 H	19 H				
100 VDC	11.4 mA		8,800 Ω	43 H	73 H				

Note: 1. The rated current and coil resistance are measured at a coil temperature of 23°C with tolerances of +15%/–20% for AC rated current and ±15% for DC coil resistance.

- The AC coil resistance and coil inductance values are for reference only.
- Performance characteristic data is measured at a coil temperature of 23°C.
- The maximum voltage is one that is applicable instantaneously to the Relay coil at an ambient temperature of 23°C and not continuously.
- For built-in operation indicator models rated at 6, 12, and 24 VDC, add an LED current of approx. 5 mA to the rated currents.

## ■ Contact Ratings

Load	Resistive load (cosφ = 1)	Inductive load (cosφ = 0.4) (L/R = 7 ms)
Contact type	Crossbar bifurcated	
Contact material	Movable: AgAu-clad AgPd Fixed: AgPd	
Rated load	0.3 A at 110 VAC 0.5 A at 24 VDC	0.2 A at 110 VAC 0.3 A at 24 VDC
Rated carry current	3 A	
Max. switching power	250 VAC, 125 VDC	

## ■ Characteristics

Classification	Standard/Acr barrier equipped/Built-in operation indicator models (G2A-□-N)	Built-in diode/Built-in operation indicator models (G2A-□-N1)
Contact resistance (see note 2)	100 mΩ max.	
Operate time (see note 3)	15 ms max.	
Release time (see note 3)	15 ms max.	30 ms max.
Max. operating frequency	Mechanical: 18,000 operations/hour Electrical: 1,800 operations/hour (under rated load)	
Insulation resistance (see note 4)	100 MΩ min. (at 500 VDC)	
Dielectric strength	1,500 VAC, 50/60 Hz for 1 min between coil and contacts and contacts of different polarities (700 VAC between contacts of same polarity)	
Vibration resistance	Destruction: 10 to 55 to 10 Hz, 0.75 mm single amplitude (1.5 mm double amplitude) Malfunction: 10 to 55 to 10 Hz, 0.5 mm single amplitude (1.0 mm double amplitude)	
Shock resistance	Destruction: 1,000 m/s <sup>2</sup> Malfunction: 100 m/s <sup>2</sup>	
Error rate (level P) (Reference value) (see note 6)	1 mA at 100 mVDC	
Endurance	Mechanical: 100,000,000 operations min. (at operating frequency of 18,000 operations/hour) Electrical: 5,000,000 operations min. (under rated load and at operating frequency of 1,800 operations/hour) (see note 5)	
Ambient temperature	Operating: -10°C to 40°C (with no icing or condensation)	
Ambient humidity	Operating: 5% to 85%	
Weight	Approx. 38 g	

Note: 1. The data shown above are initial values.

2. The contact resistance was measured with 0.1 A at 5 VDC using the voltage drop method.
3. The operate or release time was measured with the rated voltage imposed with any contact bounce ignored at an ambient temperature of 23°C.
4. The insulation resistance was measured with a 500-VDC megger applied to the same places as those used for checking the dielectric strength.
5. The electrical endurance was measured at an ambient temperature of 23°C.
6. This value was measured at a switching frequency of 60 operations per minute.

## ■ Approved by Standards

### UL508 (File No. E41515)

Model	Coil ratings	Contact ratings
G2A-□-US	6 to 120 VAC 6 to 120 VDC	1 A 120 VAC (resistive load) 1 A 30 VDC (inductive load)

# Engineering Data

## Maximum Switching Power

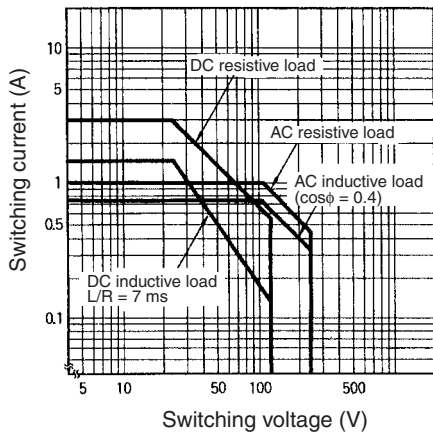

## Endurance

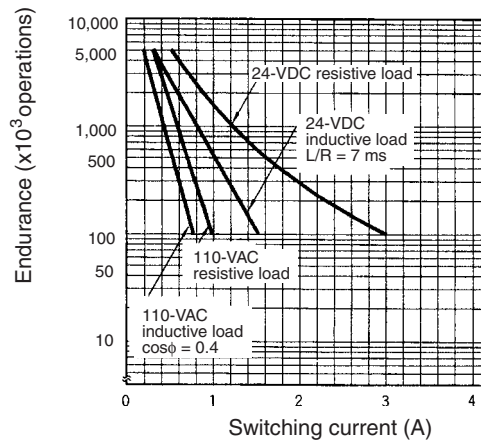

## Ambient Temperature vs. Must-operate and Must-release Voltage

### G2A AC (60 Hz)

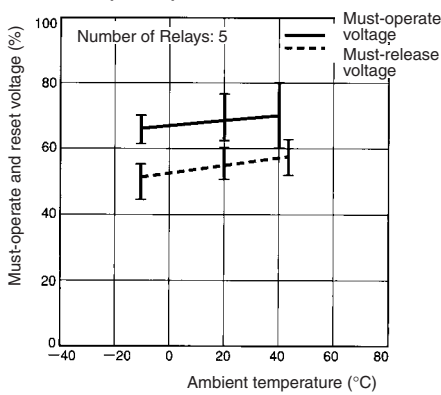

## Ambient Temperature vs. Coil Temperature Rise

### G2A 110 VAC (50 Hz)

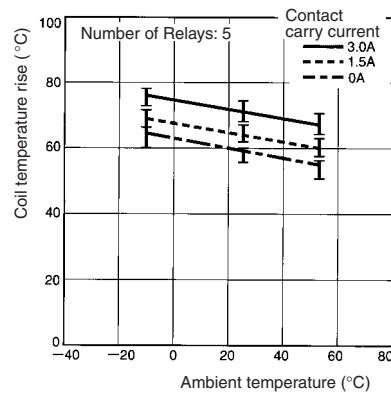

## Malfunctioning Shock

### G2A-432A 100/110 VAC

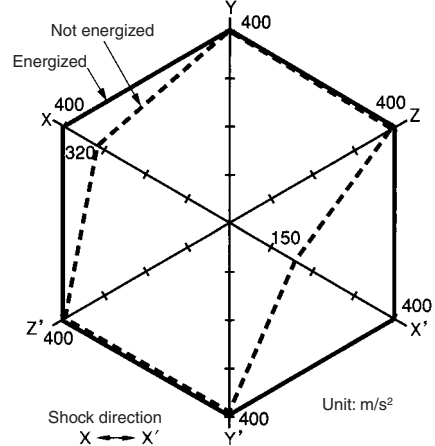

### G2A DC

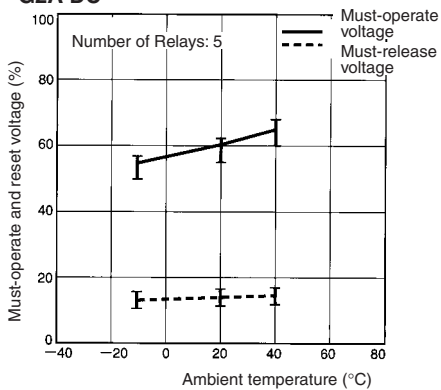

### G2A DC

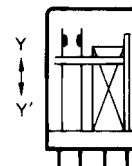
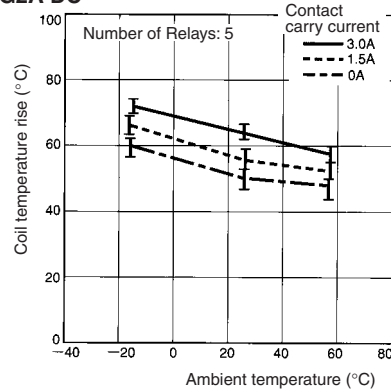

Number of samples = 5

Measurement conditions: Impose a shock of 100 m/s<sup>2</sup> in the ±X, ±Y, and ±Z directions three times each with the Relay energized and not energized to check the shock values that cause the Relay to malfunction.

**Contact Reliability  
(JIS C 4530 Allen-Bradley Test Circuit)**

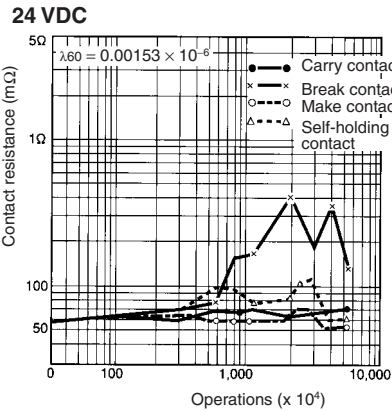
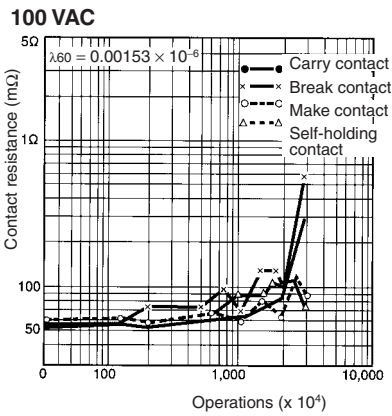

**Contact Reliability  
(Improved Allen-Bradley Test Circuit)**

Contact load: 1 mA at 5 VDC (resistive load)  
Failure criterion contact resistance: 100 Ω

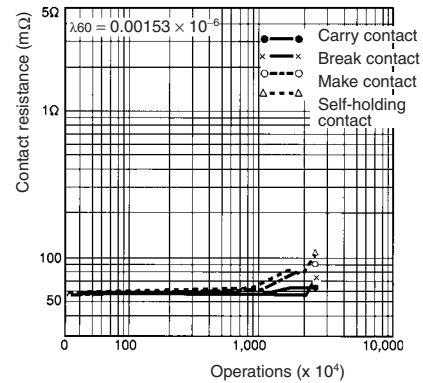

**Coil Self-load Life Curve**

(Unit: mA)

Model	Specifications	No. of Relays				
		1	2	3	5	10
G2A-432A	100 VAC, 60 Hz	14	28	42	70	140
	24 VDC	45	90	135	225	450

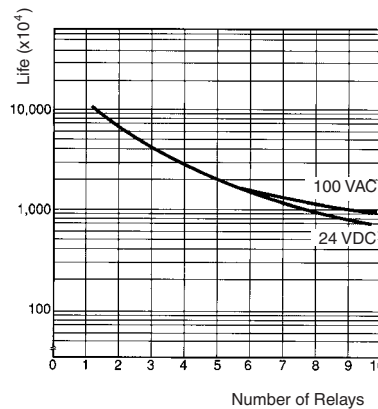

**Relay Mounting Adjacent Distance vs. Coil Temperature Rise**

**G2A-432A 24 VDC**

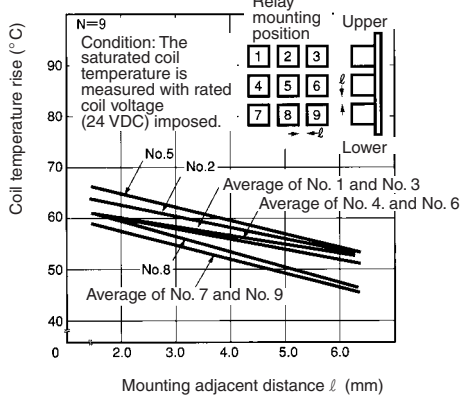

**110 VAC**

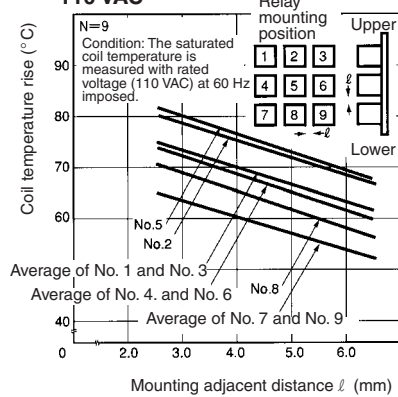

# Accessories (Order Separately)

## Connecting Sockets

Front-connecting Socket	Back-connecting Socket					
DIN track/screw mounting	Solder terminals		Wire-wrap terminals		PCB terminals	
PYF14A(-E) PYF14A-TU PYF14T	PY14 PY14-Y3	PY14-Y2 (with Relay Hold-down Clip)	PY14QN(2)	PY14QN(2)-Y2 (with Relay Hold-down Clip)	PY14-0	PY14-02

- Note:**
1. The PYF□A-TU is a high-humidity relay with nickel-plated rustproof terminal screws that are the same as the PYF□A in size.
  2. The PYF14T is slightly different from the PYF14A(-TU) in shape and size.
  3. The PYF□A-E is a finger-protection model, for which round terminals are not available. Use fork-shaped terminals or equivalent ones instead.

### PY14-3 Back-connecting Socket (with check terminals for operation monitoring)

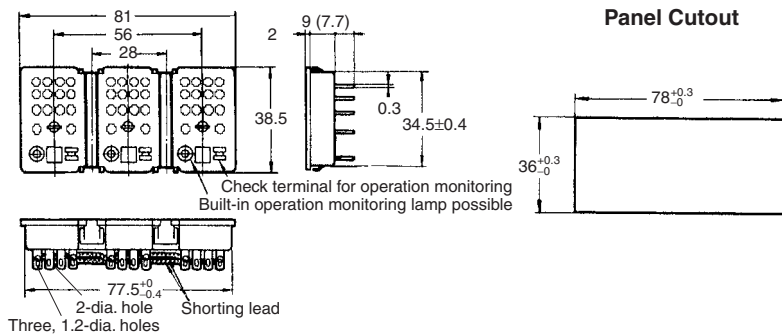
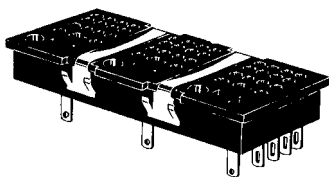

### Relay Mounting Height with Socket

With Front-connecting Socket

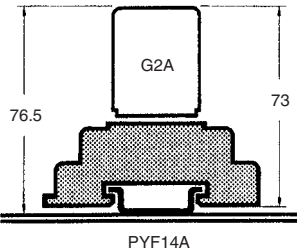

Note: PYF14A can be used for both DIN track mounting and screw mounting.

With Back-connecting Socket

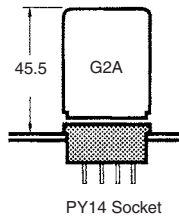

## Relay Hold-down Clips

For Front-connecting Socket	For Back-connecting Socket		For Socket mounting plate
PYC-A2	PYC-3	PYC-5	PYC-2

**Note:** When using a Relay Hold-down Clip for the built-in operation indicator model, use of the PYC-A2 or PYC-5, which allows easy viewing of the indicator, is recommended.

# Dimensions

- Note:** 1. All units are in millimeters unless otherwise indicated.  
 2. Dimensional tolerances are  $\pm 0.1$  mm.

## Solder Terminal Models

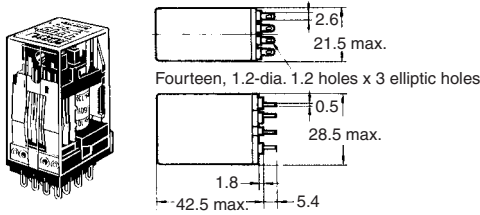

## PCB Terminal Models

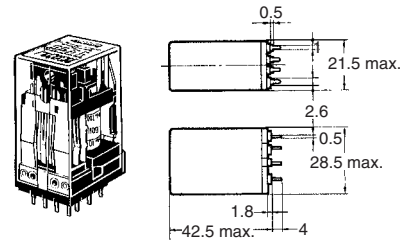

## Mounting Holes on PCB (Bottom View)

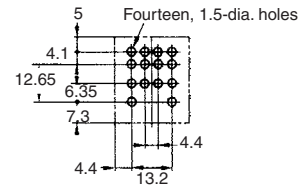

## Terminal Arrangement/Internal Connections (Bottom View)

### Standard Models

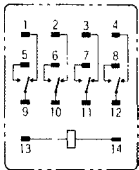

### Make-before-break Contact Models

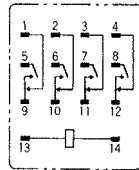

### Arc Barrier Equipped Models

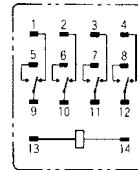

### Built-in Diode Models

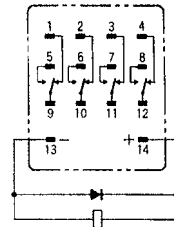

## Built-in Operation Indicator Models

Color of operation indicator  
 AC model: Red  
 DC model: Green

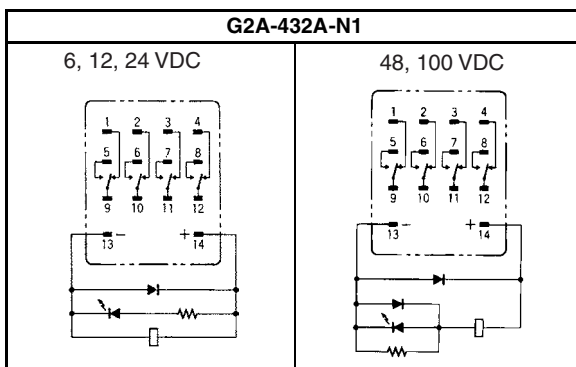
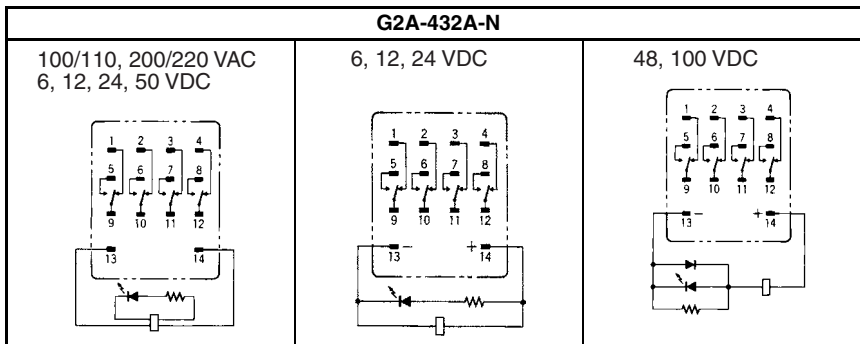

**Note:** Do not reverse the polarity of the coil of DC Relays that have a built-in indicator or diode.

**Socket Mounting Plates** (t = 1.6 mm)

Use any of these plates when mounting two or more Sockets side-by-side

PYP-1 (for Single Socket Mounting)

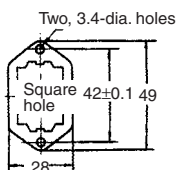

PYP-18 (for Mounting 18 Sockets)

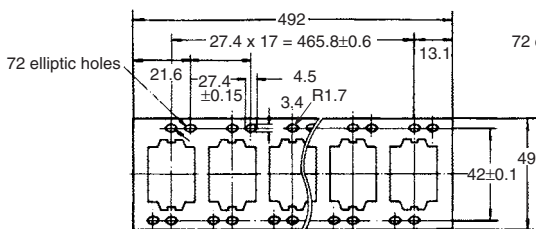

Note: PYP-18 and PYP-36 can be cut to a desired length for mounting less than 18 or 36 Sockets, respectively.

PYP-36 (for Mounting 36 Sockets)

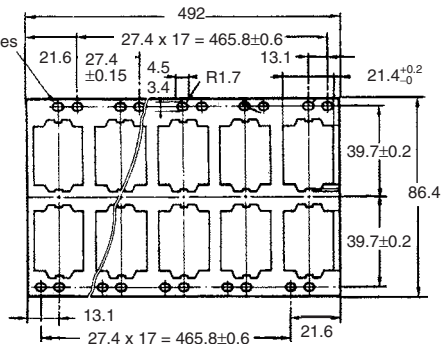

## Precautions

Refer to page 11 for general precautions.

A DC coil model with a built-in indicator or built-in diode has coil polarity. Be sure to wire the terminals correctly, otherwise the diode may be broken or the operating indicator may not be lit. Furthermore, as a result of the short-circuiting of the built-in diode, the devices in the circuit may be damaged.

ALL DIMENSIONS SHOWN ARE IN MILLIMETERS.

To convert millimeters into inches, multiply by 0.03937. To convert grams into ounces, multiply by 0.03527.