

Solid State Relays (SSRs) G3PA/G3PB

Long Service Life for Circuits that Cycle Frequently

- Built-in heat sink increases life and reliability
- Voltage turn-on at zero crossing reduces initial inrush load currents
- LED indicator turns on when control power is applied
- DIN rail mountable
- Conforms to UL, CSA, VDE and CE requirements

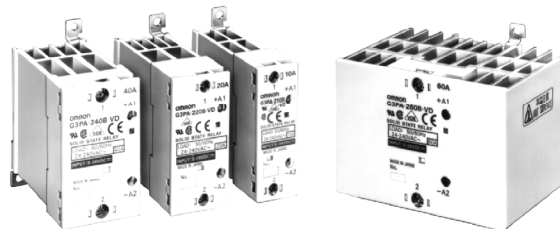

Ordering Information

■ G3PA Relays with Replaceable Triac Output Cartridge

- Current indicator turns red when excessive current is applied
- Side-by-side dense mounting is possible using built-in linking brackets

Single-Phase Models

Stock Note: Shaded models are normally stocked.

Max. load current	Max. inrush current	Operating voltage	Load voltage	Model
10 amps	150 amps, 60 Hz	5-24 VDC	24-240 VAC	G3PA-210B-VD DC5-24
20 amps	220 amps, 60 Hz			G3PA-220B-VD DC5-24
40 amps	440 amps, 60 Hz			G3PA-240B-VD DC5-24
60 amps	440 amps, 60 Hz			G3PA-260B-VD DC5-24
20 amps	220 amps, 60 Hz	12-24 VDC	200-480 VAC	G3PA-420B-VD-2 DC12-24
30 amps	440 amps, 60 Hz			G3PA-430B-VD-2 DC12-24
50 amps	440 amps, 60 Hz			G3PA-450B-VD-2 DC12-24

■ G3PB Relays

Single Phase Models

Stock Note: Shaded models are normally stocked.

Max. load current	Max. inrush current	Operating voltage	Load voltage	Model
15 amps	150 amps, 60 Hz	12-24 VDC	100-240 VAC	G3PB-215B-VD DC12-24
25 amps	220 amps, 60 Hz			G3PB-225B-VD DC12-24
35 amps	440 amps, 60 Hz			G3PB-235B-VD DC12-24
45 amps	440 amps, 60 Hz			G3PB-245B-VD DC12-24

■ DIN Rail Mounting Track

Stock Note: Shaded models are normally stocked.

Description	Model
DIN rail track, 7.3 mm (0.29 in) depth; 50 cm (1.64 ft) length	PFP-50N
DIN rail track, 7.3 mm (0.29 in) depth; 1 m (3.28 ft) length	PFP-100N
End plate	PFP-M
Spacer	PFP-S

■ Replacement Parts

Stock Note: Shaded models are normally stocked.

Name	Carry current	Applicable SSR	Model
Power device cartridge	10 A	G3PA-210B-VD DC5-24	G32A-A10-VD DC5-24
		G3PA-210BL-VD DC5-24	G32A-A10L-VD DC5-24
		G3PA-210-VD AC24	G32A-A10-VD AC24
	20 A	G3PA-220-VD DC5-24	G32A-A20-VD DC5-24
		G3PA-220L-VD DC5-24	G32A-A20L-VD DC5-24
		G3PA-220-VD AC24	G32A-A20-VD AC24
	40 A	G3PA-240-VD DC5-24	G32A-A40-VD DC5-24
		G3PA-240L-VD DC5-24	G32A-A40L-VD DC5-24
		G3PA-240-VD AC24	G32A-A40-VD AC24
	60 A	G3PA-260-VD DC5-24	G32A-A60-VD DC5-24
		G3PA-260L-VD DC5-24	G32A-A60L-VD DC5-24
		G3PA-260-VD AC24	G32A-A60-VD AC24
	20 A	G3PA-420-VD DC12-24	G32A-A420-VD DC12-24
	30 A	G3PA-430-VD DC12-24	G32A-A430-VD DC12-24
	20 A	G3PA-420-VD-2 DC5-24	G32A-A420-VD-2 DC5-24
30 A	G3PA-430-VD-2 DC5-24	G32A-A430-VD-2 DC5-24	
50 A	G3PA-450-VD-2 DC5-24	G32A-A450-VD-2 DC5-24	

Application Examples

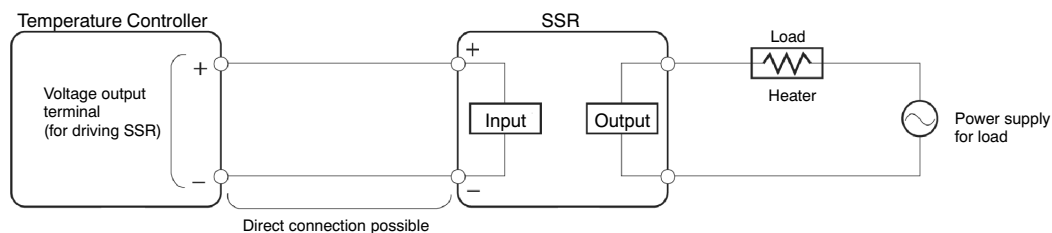

Omron's SSRs offer these advantages over electro-mechanical relays (EMRs):

- Longer service life with no contacts to wear out
- Reduced electromagnetic interference
- Faster response time
- Vibration and shock resistance
- No audible noise when switching
- Enhanced reliability

Specifications

■ Ratings

Input (at 25°C)

Model	Rated voltage	Voltage range	Input current impedance	Voltage level	
				Must operate voltage	Must release voltage
G3PA-210B-VD	5 to 24 VDC	4 to 30 VDC	7 mA max.	4 VDC max.	1 VDC min.
G3PA-220B-VD					
G3PA-240B-VD					
G3PA-260B-VD					
G3PA-420B-VD-2	12 to 24 VDC	9.6 to 30 VDC	7 mA max.	9.6 VDC max.	1 VDC min.
G3PA-430B-VD-2					
G3PA-450B-VD-2					
G3PB-215B-VD	12 to 24 VDC	9.6 to 30 VDC	7 mA max.	9.6 VDC max.	1 VDC min.
G3PB-225B-VD					
G3PB-235B-VD					
G3PB-245B-VD					

Output

Model	Applicable load			
	Load voltage	Load current	Inrush current	With Class-1 AC resistive load
G3PA-210B-VD	19 to 264 VAC (50/60 Hz)	0.1 to 10 A	150 A (60 Hz, 1 cycle)	2.4 kW at 240 VAC
G3PA-220B-VD		0.1 to 20 A	220 A (60 Hz, 1 cycle)	4.8 kW at 240 VAC
G3PA-240B-VD		0.5 to 40 A	440 A (60 Hz, 1 cycle)	9.6 kW at 240 VAC
G3PA-260B-VD		0.5 to 60 A	440 A (60 Hz, 1 cycle)	14.4 kW at 240 VAC
G3PA-420B-VD-2	180 to 528 VAC (50/60 Hz)	0.5 to 20 A	220 A (60 Hz, 1 cycle)	9.6 kW at 480 VAC
G3PA-430B-VD-2		0.5 to 30 A	440 A (60 Hz, 1 cycle)	14.4 kW at 480 VAC
G3PA-450B-VD-2		0.5 to 50 A	440 A (60 Hz, 1 cycle)	24 kW at 480 VAC
G3PB-215B-VD	75 to 264 VAC (50/60 Hz)	0.1 to 15 A	150 A (60 Hz, 1 cycle)	3 kW at 200 VAC
G3PB-225B-VD		0.1 to 25 A	220 A (60 Hz, 1 cycle)	5 kW at 200 VAC
G3PB-235B-VD		0.5 to 35 A	440 A (60 Hz, 1 cycle)	7 kW at 200 VAC
G3PB-245B-VD		0.5 to 45 A	440 A (60 Hz, 1 cycle)	9 kW at 200 VAC

■ Characteristics

G3PA

Item	G3PA-210B-VD	G3PA-220B-VD	G3PA-240B-VD	G3PA-260B-VD	G3PA-420B-VD-2	G3PA-430B-VD-2	G3PA-450B-VD-2
Operate time	1/2 of load power source cycle + 1 ms max. (DC Input, -B models) 1 1/2 of load power source cycle + 1 ms max. (AC Input)						
Release time	1/2 of load power source cycle + 1 ms max. (DC Input) 1 1/2 of load power source cycle + 1 ms max. (AC Input)						
Output ON voltage drop	1.6 V (RMS) max.				1.8 V (RMS) max.		
Leakage current	5 mA max. at 120 VAC 10 mA max. at 230 VAC		10 mA max. at 120 VAC 20 mA max. at 230 VAC		20 mA max. at 400 VAC		
I²t	260 A ² S		810 A ² S		260 A ² S	810 A ² S	
Insulation resistance	100 MΩ min. at 500 VDC						
Dielectric strength	4,000 VAC, 50/60 Hz for 1 min						
Vibration resistance	Malfunction: 10 to 55 Hz, 0.75-mm double amplitude (mounted to DIN rail)						
Shock resistance	Malfunction: 300 m/s ² (mounted to DIN rail)						
Ambient temperature	Operating: -30°C to 80°C (with no icing or condensation) Storage: -30°C to 100°C (with no icing or condensation)						
Approved standards	UL508 File No.E64562, CSA C22.2 (No.14, No.950) File No.LR35535, EN60950 File No. 5915UG						
Ambient humidity	Operating: 45% to 85%						
Weight	Approx. 260 g	Approx. 340 g	Approx. 460 g	Approx. 900 g	Approx. 290 g	Approx. 410 g	Approx. 900 g

G3PB

Part number	G3PB-215B-VD	G3PB-225B-VD	G3PB-235B-VD	G3PB-245B-VD
Operate time	1/2 of load power source cycle + 1 ms max. (DC input)			
Release time	1/2 of load power source cycle + 1 ms max. (DC input)			
Output ON voltage drop	1.6 V (RMS) max.			
Leakage current	10 mA max. (at 200 VAC)			
Permissible I²t (half 60-Hz wave)	121 A ² s	260 A ² s	1,260 A ² s	
Insulation resistance	100 MΩ min. at 500 VDC			
Dielectric strength	2,500 VAC, 50/60 Hz for 1 min			
Vibration resistance	Destruction and malfunction: 10 to 55 Hz, 0.75-mm double amplitude			
Shock resistance	Destruction: 294 m/s ² Malfunction: 294 m/s ² (DIN track mounting)			
Ambient temperature	Operating: -30°C to 80°C (with no icing or condensation) Storage: -30°C to 100°C (with no icing or condensation)			
Approved standards	UL508 File No. E64562 (From April 1999) CSA22.2 No. 14 File No. LR35535 (From April 1999) IEC947-4-3 File No. 6825 UG			
Ambient humidity	Operating: 45% to 85%			
Weight	Approx. 240 g	Approx. 240 g	Approx. 400 g	Approx. 400 g

Dimensions

Unit: mm (inch)

■ Solid State Relays With Built-in Heat Sinks

G3PA-210B-VD

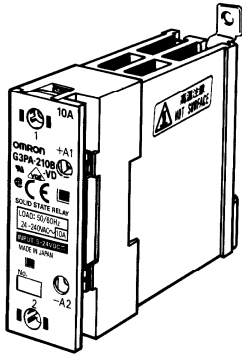

Without Terminal Cover

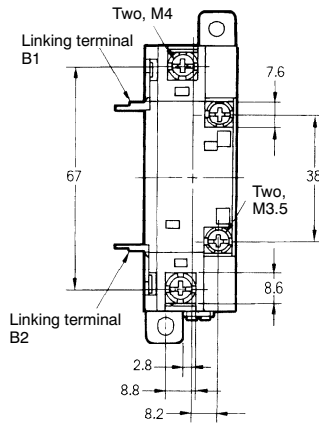

With Terminal Cover

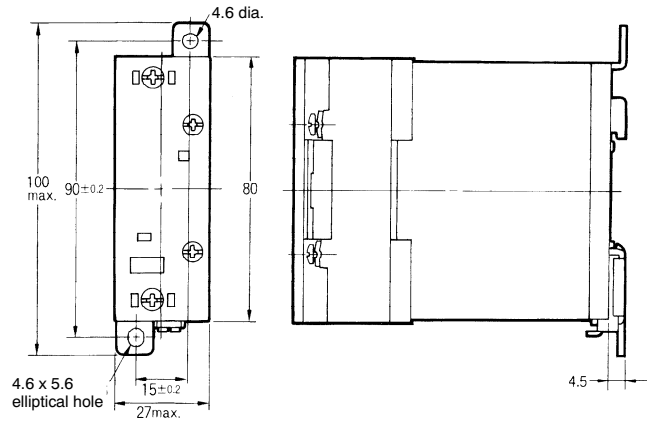

Mounting Holes

Two, 4.5 dia. or M4 holes

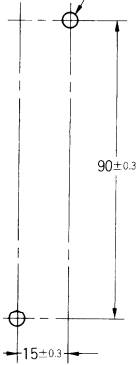

Terminal Arrangement/
Internal Connections

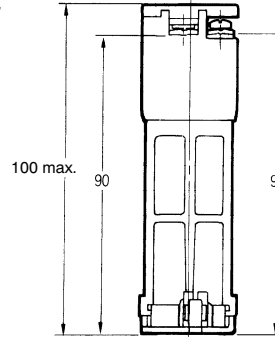
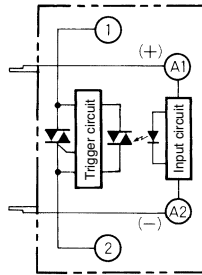

G3PA-220B-VD

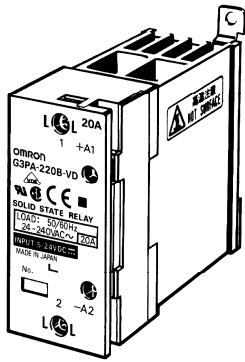

Without Terminal Cover

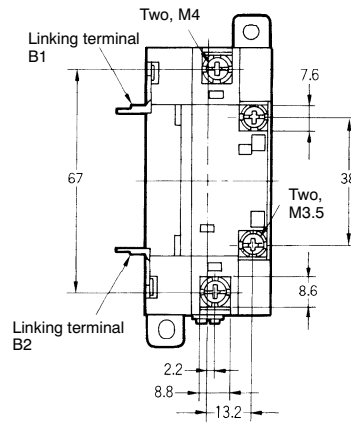

With Terminal Cover

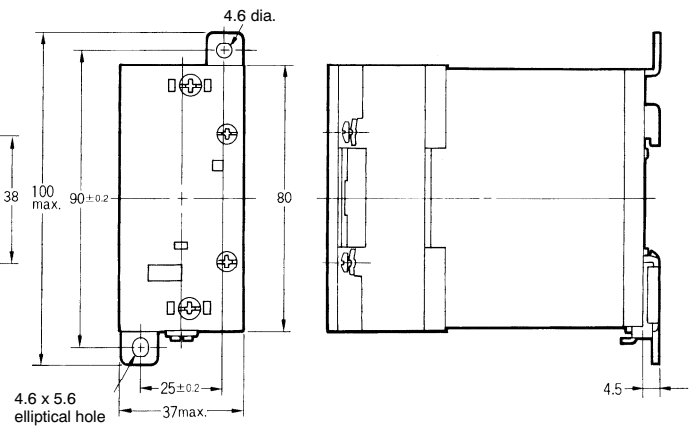

Mounting Holes

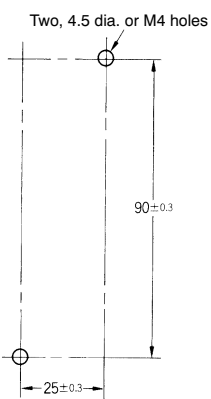

Terminal Arrangement/
Internal Connections

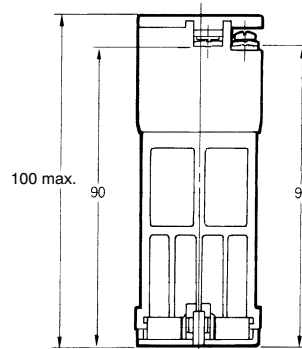
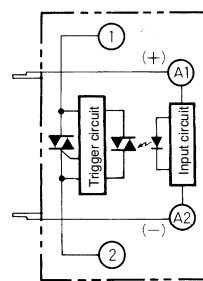

G3PA-240B-VD

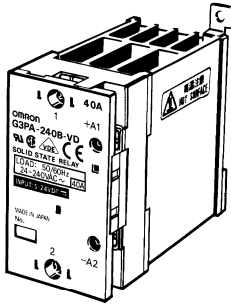

Without Terminal Cover

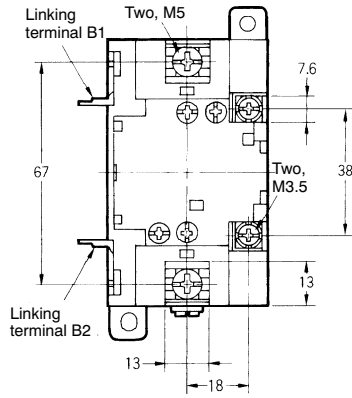

With Terminal Cover

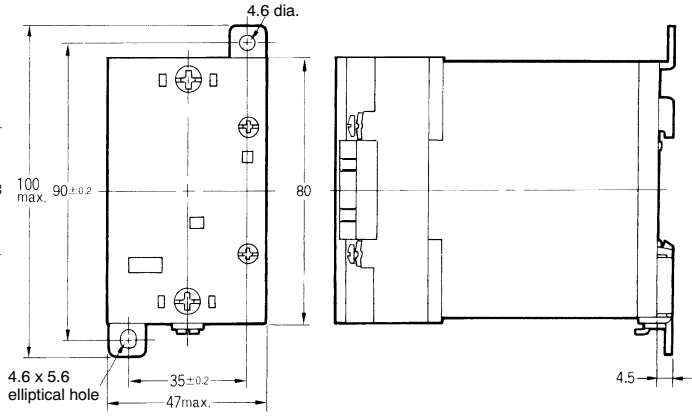

Mounting Holes

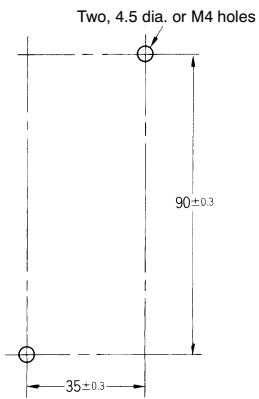

Terminal Arrangement/
Internal Connections

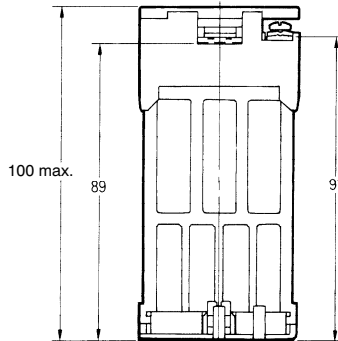
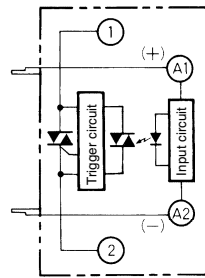

G3PA-260B-VD
G3PA-450B-VD-2

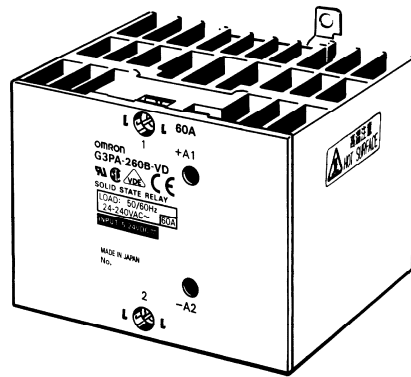

Without Terminal Cover

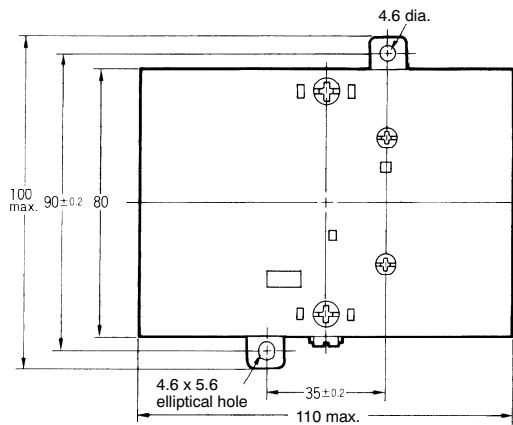

With Terminal Cover

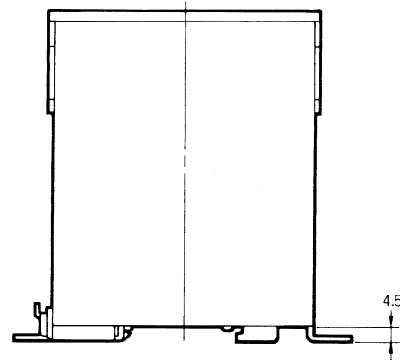
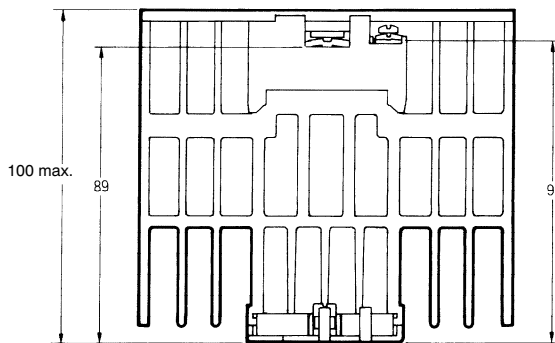
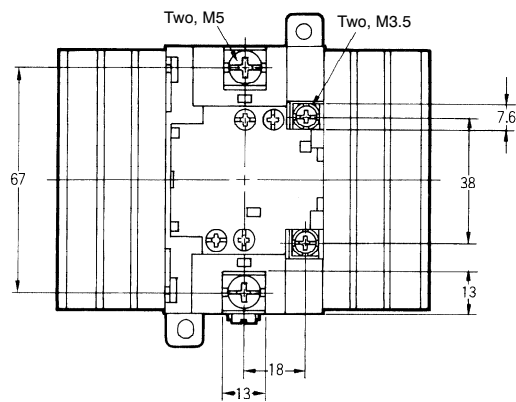

Mounting Holes

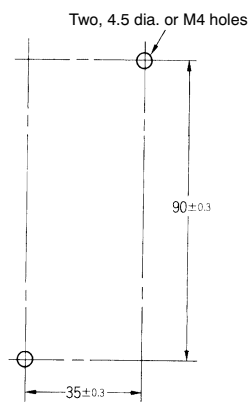

Terminal Arrangement/
Internal Connections

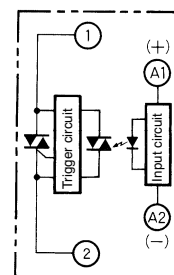

G3PA-420B-VD-2

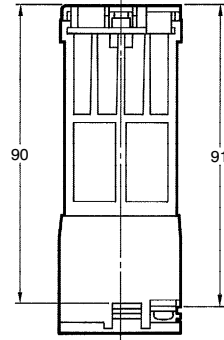
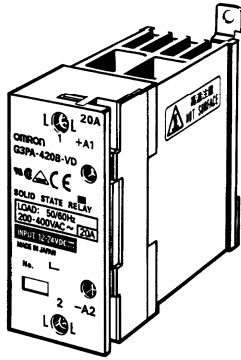

Terminal Arrangement/
Internal Connections

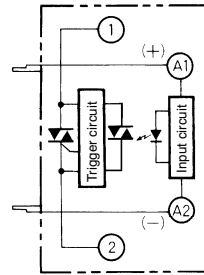

Mounting Holes

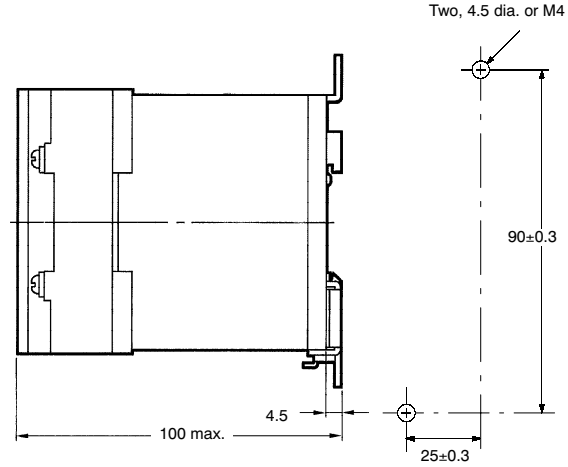
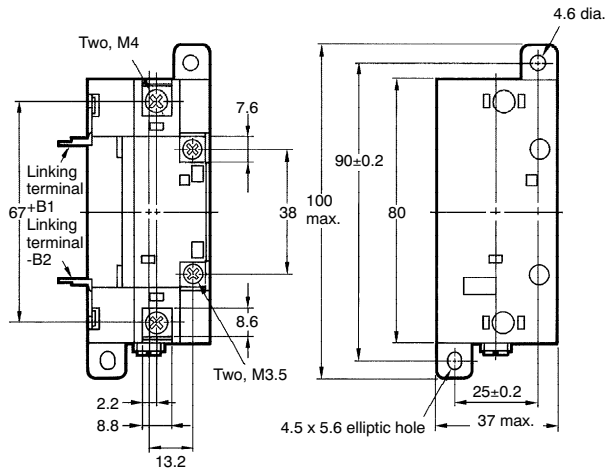

G3PA-430B-VD-2

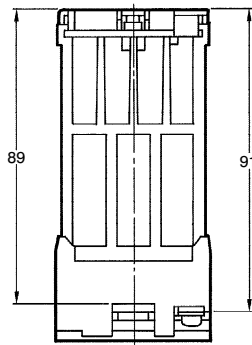
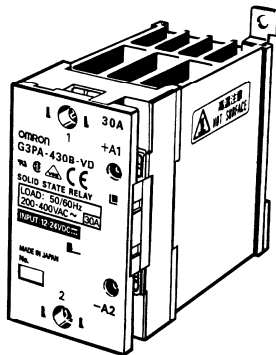

Terminal Arrangement/
Internal Connections

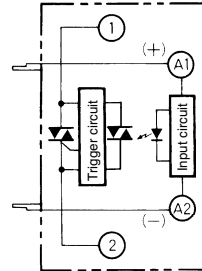

Mounting Holes

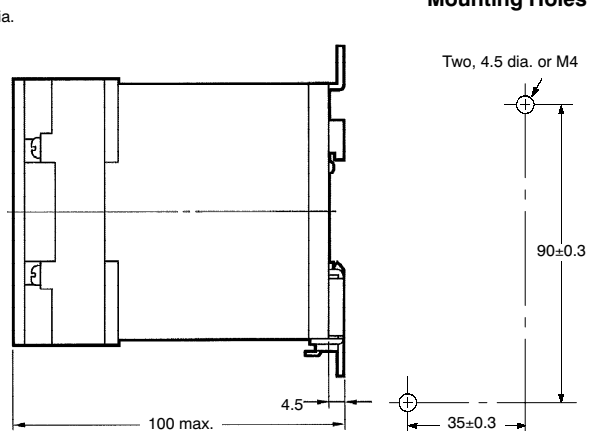
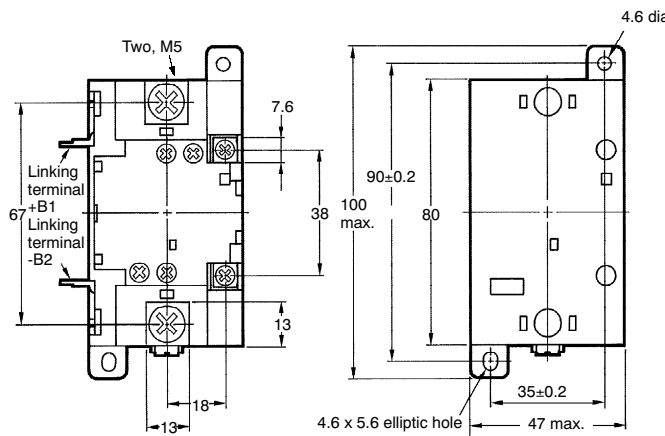

Single-phase Models

G3PB-215B-VD
G3PB-225B-VD

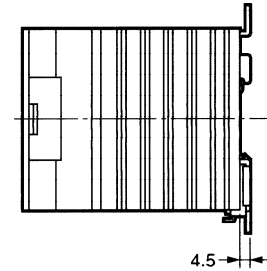
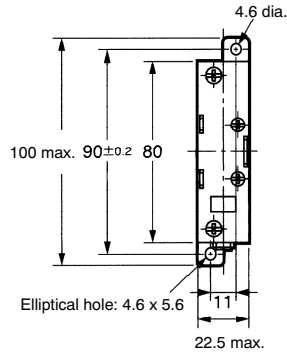
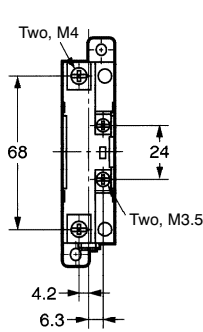
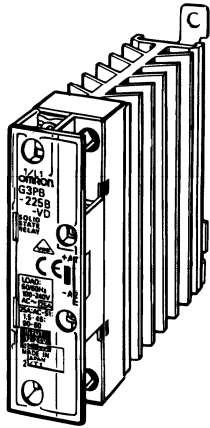

Mounting Holes

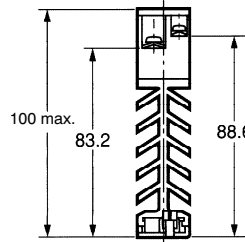
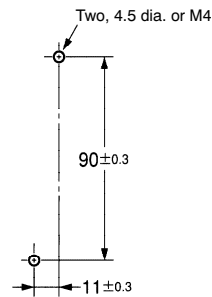

Terminal Arrangement/
Internal Circuit Diagram

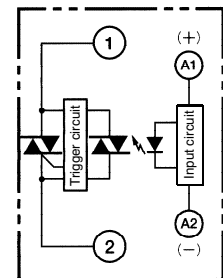

G3PB-235B-VD
G3PB-245B-VD

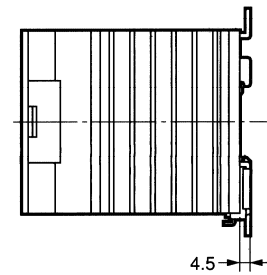
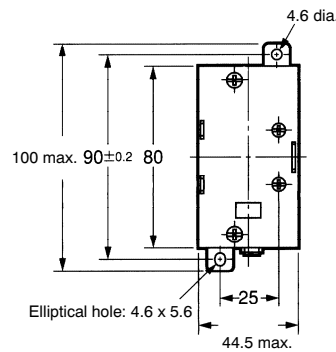
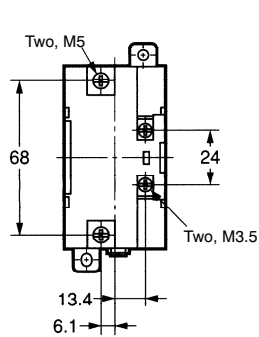
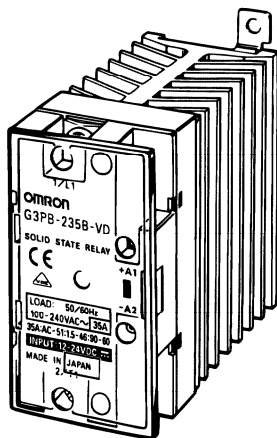

Mounting Holes

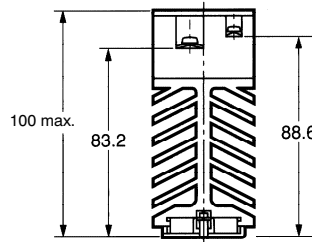
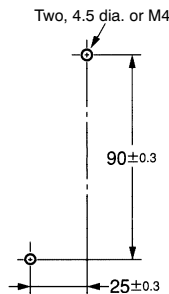

Terminal Arrangement/
Internal Circuit Diagram

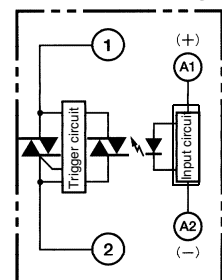

Precautions

⚠ WARNING

Do not touch the terminals (i.e., charged parts) of the G3PB while power is supplied, otherwise an electric shock may be received.

If the G3PB is provided with a terminal cover, be sure to attach the terminal cover to the G3PB before operating the G3PB.

The G3PB and radiator are very hot while power is supplied to the G3PB.

Do not touch the G3PB or the radiator while power is supplied to the G3PB or immediately after the G3PB is turned OFF, otherwise a burn may result.

Do not touch the load terminal of the G3PB immediately after the G3PB is turned OFF, otherwise an electric shock may be received due to the residual charge of the built-in snubber circuit.

Be sure to turn OFF the power supply to the G3PB before wiring, otherwise an electric shock may be received.

Mount the terminal cover to the G3PB after wiring.

Do not touch the terminals of the G3PB while power is supplied, otherwise an electric shock may be received.

The built-in capacitor will be charged as long as power is supplied. Do not touch the terminals of the G3PB unless the G3PB is turned OFF and the built-in capacitor discharges all of its residual voltage, otherwise an electric shock may result.

⚠ Caution

Do not apply excessive voltage or current to the input or output circuit of the G3PB, otherwise the G3PB may malfunction or burn.

Do not use the G3PB unless all the output terminal screws are tightened securely, otherwise the terminals may generate excessive heat and the G3PB may burn.

Be sure to provide enough ventilation to the G3PB and the radiator, otherwise the G3PB may generate excessive heat and the G3PB may burn or the output element may short-circuit.

Be sure to turn OFF the power supply to the G3PB before wiring, otherwise an electric shock may be received.

Be sure to wire or solder the terminals of the G3PB properly, otherwise the G3PB may generate excessive heat and burn.

If the G3PB is mounted directly to a control panel that is used as a radiator as well, the control panel must be made of aluminum or a steel plate with low thermal resistance.

Do not use any material with high thermal resistance, such as a wooden plate, otherwise the G3PB may catch on fire or burn.

■ Before Actual Operation

- The G3PB in operation may cause an unexpected accident. Therefore it is necessary to test the G3PB under a variety of conditions that are possible. As for the characteristics of the G3PB, it is necessary to take into consideration the dispersion of the characteristics between G3PB Units.
- The ratings in this datasheet are tested values in a temperature range between 15°C and 30°C, a relative humidity range between 25% and 85%, and an atmospheric pressure range between 88 and 106 kPa. It will be necessary to provide the above conditions as well as the load conditions if the user wants to confirm the ratings of actual G3PB Units.

■ Mounting Method

Since the Relay is heavy, firmly mount the DIN track and fix both ends with End Plates for DIN-track-mounting models. For direct mounting, firmly mount the Relay on the panel.

Vertical Mounting

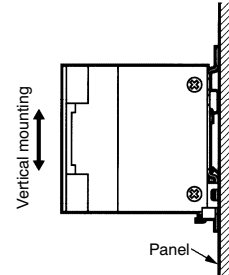

Horizontal Mounting

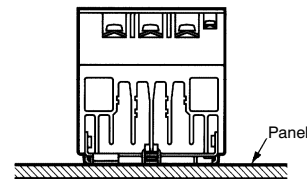

Note: Make sure that the load current is 50% of the rated load current when the G3PB is mounted horizontally.

Close Mounting

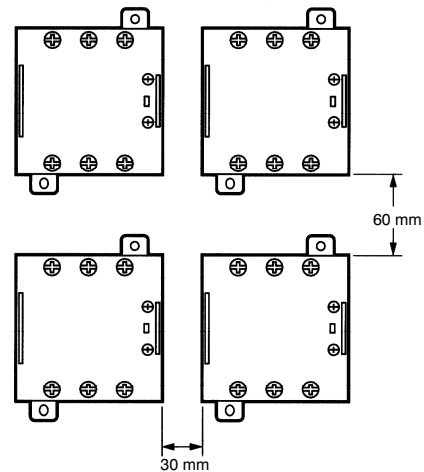

Note: Be sure to provide a minimum space of 30 mm horizontally and 60 mm vertically between adjacent Units.

■ Wiring

When using crimp terminals, refer to the terminal clearances shown below.

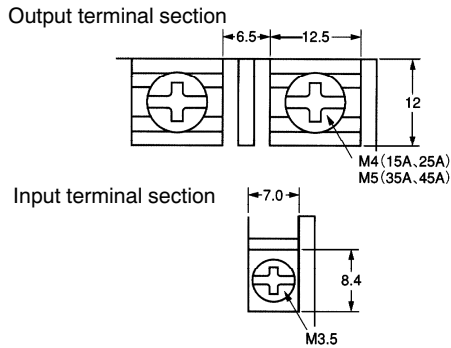

Be sure that all lead wires are thick enough according to the current.

Output terminals T1, T2, and T3 are charged regardless of whether the Unit is a 2- or 3-element model that is turned on or off. Do not touch these terminals, otherwise an electric shock may be received.

To isolate the Unit from the power supply, install an appropriate circuit breaker between the power supply and Unit.

Be sure to turn off the power supply before wiring the Unit.

Terminal L2 and terminal T2 of the 2-element model are internally short-circuited to each other. Therefore, connect terminal L2 to the ground terminal of the power supply. If terminal L2 is connected to a terminal other than the ground terminal, cover all the charged terminals, such as heater terminals, for the prevention of electric shock accidents and ground faults.

■ Tightening Torque

Refer to the following and be sure to tighten each screw of the Unit to the specified torque in order to prevent the Unit from malfunctioning.

Item	Screw terminal diameter	Tightening torque
Input terminal	M3.5	0.8 N • m
Output terminal	M4	1.2 N • m
	M5	2.0 N • m

■ Mounting Models without Built-in Heat Sink

Before attaching an external radiator or Heat Sink to the Unit, be sure to apply silicone grease for heat radiation, such as Toshiba's YG6260 or Sinetsu Silicone's G746, to the surface where the radiator or Heat Sink is attached.

Be sure to apply the following torque to secure the Unit and external radiator or Heat Sink for proper heat radiation.

Tightening torque: 2.0 N • m

■ Operating Conditions

Do not apply current exceeding the rated current. Otherwise the temperature of the Unit may rise excessively.

Be sure to prevent ambient temperature rising due to the heat radiation of the Unit. In the case of enclosed mounting, install a fan so that the interior of the panel can be fully ventilated.

■ Operating and Storage Environments

Do not use or store the Unit in the following places, otherwise the Unit may malfunction or the characteristics of the Unit may deteriorate.

- Locations subject to direct sunlight.
- Locations subject to ambient operating temperatures outside the range of -30°C to 80°C.
- Locations subject to ambient operating humidity outside the range of 45% to 85%.
- Locations subject to condensation as the result of severe changes in temperature.
- Locations subject to ambient storage temperatures outside the range of -30°C to 100°C.
- Locations subject to corrosive or flammable gases.
- Locations subject to dust (especially iron dust) or salts.
- Locations subject to shock or vibration.
- Locations subject to exposure to water, oil, or chemicals.

Certain Terms and Conditions of Sale

1. **Offer; Acceptance.** These terms and conditions (these "Terms") are deemed part of all catalogs, manuals or other documents, whether electronic or in writing, relating to the sale of goods or services (collectively, the "Goods") by Omron Electronics LLC and its subsidiary companies ("Seller"). Seller hereby objects to any terms or conditions proposed in Buyer's purchase order or other documents which are inconsistent with, or in addition to, these Terms. Please contact your Omron representative to confirm any additional terms for sales from your Omron company.
2. **Prices.** All prices stated are current, subject to change without notice by Seller. Buyer agrees to pay the price in effect at time of shipment.
3. **Discounts.** Cash discounts, if any, will apply only on the net amount of invoices sent to Buyer after deducting transportation charges, taxes and duties, and will be allowed only if (i) the invoice is paid according to Seller's payment terms and (ii) Buyer has no past due amounts owing to Seller.
4. **Orders.** Seller will accept no order less than \$200 net billing.
5. **Governmental Approvals.** Buyer shall be responsible for, and shall bear all costs involved in, obtaining any government approvals required for the importation or sale of the Goods.
6. **Taxes.** All taxes, duties and other governmental charges (other than general real property and income taxes), including any interest or penalties thereon, imposed directly or indirectly on Seller or required to be collected directly or indirectly by Seller for the manufacture, production, sale, delivery, importation, consumption or use of the Goods sold hereunder (including customs duties and sales, excise, use, turnover and license taxes) shall be charged to and remitted by Buyer to Seller.
7. **Financial.** If the financial position of Buyer at any time becomes unsatisfactory to Seller, Seller reserves the right to stop shipments or require satisfactory security or payment in advance. If Buyer fails to make payment or otherwise comply with these Terms or any related agreement, Seller may (without liability and in addition to other remedies) cancel any unshipped portion of Goods sold hereunder and stop any Goods in transit until Buyer pays all amounts, including amounts payable hereunder, whether or not then due, which are owing to it by Buyer. Buyer shall in any event remain liable for all unpaid accounts.
8. **Cancellation; Etc.** Orders are not subject to rescheduling or cancellation unless Buyer indemnifies Seller fully against all costs or expenses arising in connection therewith.
9. **Force Majeure.** Seller shall not be liable for any delay or failure in delivery resulting from causes beyond its control, including earthquakes, fires, floods, strikes or other labor disputes, shortage of labor or materials, accidents to machinery, acts of sabotage, riots, delay in or lack of transportation or the requirements of any government authority.
10. **Shipping; Delivery.** Unless otherwise expressly agreed in writing by Seller:
 - a. Shipments shall be by a carrier selected by Seller;
 - b. Such carrier shall act as the agent of Buyer and delivery to such carrier shall constitute delivery to Buyer;
 - c. All sales and shipments of Goods shall be FOB shipping point (unless otherwise stated in writing by Seller), at which point title to and all risk of loss of the Goods shall pass from Seller to Buyer, provided that Seller shall retain a security interest in the Goods until the full purchase price is paid by Buyer;
 - d. Delivery and shipping dates are estimates only.
 - e. Seller will package Goods as it deems proper for protection against normal handling and extra charges apply to special conditions.
11. **Claims.** Any claim by Buyer against Seller for shortage or damage to the Goods occurring before delivery to the carrier must be presented in writing to Seller within 30 days of receipt of shipment and include the original transportation bill signed by the carrier noting that the carrier received the Goods from Seller in the condition claimed.
12. **Warranties.** (a) **Exclusive Warranty.** Seller's exclusive warranty is that the Goods will be free from defects in materials and workmanship for a period of twelve months from the date of sale by Seller (or such other period expressed in writing by Seller). Seller disclaims all other warranties, express or implied. (b) **Limitations.** SELLER MAKES NO WARRANTY OR REPRESENTATION, EXPRESS OR IMPLIED, ABOUT NON-INFRINGEMENT, MERCHANTABILITY OR FITNESS FOR A PARTICULAR PURPOSE OF THE GOODS. BUYER ACKNOWLEDGES THAT IT ALONE HAS DETERMINED THAT THE GOODS WILL SUITABLY MEET THE REQUIREMENTS OF THEIR INTENDED USE. Seller further disclaims all warranties and responsibility of any type for claims or expenses based on infringement by the Goods or otherwise of any intellectual property right. (c) **Buyer Remedy.** Seller's sole obligation hereunder shall be to replace (in the form originally shipped with Buyer responsible for labor charges for removal or replacement thereof) the non-complying Good or, at Seller's election, to repay or credit Buyer an amount equal to the purchase price of the Good; provided that in no event shall Seller be responsible for warranty, repair, indemnity or any other claims or expenses regarding the Goods unless Seller's analysis confirms that the Goods were properly handled, stored, installed and maintained and not subject to contamination, abuse, misuse or inappropriate modification. Return of any goods by Buyer must be approved in writing by Seller before shipment. Seller shall not be liable for the suitability or unsuitability or the results from the use of Goods in combination with any electrical or electronic components, circuits, system assemblies or any other materials or substances or environments. Any advice, recommendations or information given orally or in writing, are not to be construed as an amendment or addition to the above warranty.
13. **Damage Limits; Etc.** SELLER SHALL NOT BE LIABLE FOR SPECIAL, INDIRECT OR CONSEQUENTIAL DAMAGES, LOSS OF PROFITS OR PRODUCTION OR COMMERCIAL LOSS IN ANY WAY CONNECTED WITH THE GOODS, WHETHER SUCH CLAIM IS BASED IN CONTRACT, WARRANTY, NEGLIGENCE OR STRICT LIABILITY. Further, in no event shall liability of Seller exceed the individual price of the Good on which liability is asserted.
14. **Indemnities.** Buyer shall indemnify and hold harmless Seller, its affiliates and its employees from and against all liabilities, losses, claims, costs and expenses (including attorney's fees and expenses) related to any claim, investigation, litigation or proceeding (whether or not Seller is a party) which arises or is alleged to arise from Buyer's acts or omissions under these Terms or in any way with respect to the Goods. Without limiting the foregoing, Buyer (at its own expense) shall indemnify and hold harmless Seller and defend or settle any action brought against Seller to the extent that it is based on a claim that any Good made to Buyer specifications infringed intellectual property rights of another party.
15. **Property; Confidentiality.** The intellectual property embodied in the Goods is the exclusive property of Seller and its affiliates and Buyer shall not attempt to duplicate it in any way without the written permission of Seller. Notwithstanding any charges to Buyer for engineering or tooling, all engineering and tooling shall remain the exclusive property of Seller. All information and materials supplied by Seller to Buyer relating to the Goods are confidential and proprietary, and Buyer shall limit distribution thereof to its trusted employees and strictly prevent disclosure to any third party.
16. **Miscellaneous.** (a) **Waiver.** No failure or delay by Seller in exercising any right and no course of dealing between Buyer and Seller shall operate as a waiver of rights by Seller. (b) **Assignment.** Buyer may not assign its rights hereunder without Seller's written consent. (c) **Amendment.** These Terms constitute the entire agreement between Buyer and Seller relating to the Goods, and no provision may be changed or waived unless in writing signed by the parties. (d) **Severability.** If any provision hereof is rendered ineffective or invalid, such provision shall not invalidate any other provision. (e) **Setoff.** Buyer shall have no right to set off any amounts against the amount owing in respect of this invoice. (f) As used herein, "including" means "including without limitation".

Certain Precautions on Specifications and Use

1. **Suitability of Use.** Seller shall not be responsible for conformity with any standards, codes or regulations which apply to the combination of the Good in the Buyer's application or use of the Good. At Buyer's request, Seller will provide applicable third party certification documents identifying ratings and limitations of use which apply to the Good. This information by itself is not sufficient for a complete determination of the suitability of the Good in combination with the end product, machine, system, or other application or use. The following are some examples of applications for which particular attention must be given. This is not intended to be an exhaustive list of all possible uses of this Good, nor is it intended to imply that the uses listed may be suitable for this Good:
 - (i) Outdoor use, uses involving potential chemical contamination or electrical interference, or conditions or uses not described in this document.
 - (ii) Energy control systems, combustion systems, railroad systems, aviation systems, medical equipment, amusement machines, vehicles, safety equipment, and installations subject to separate industry or government regulations.
 - (iii) Systems, machines and equipment that could present a risk to life or property. Please know and observe all prohibitions of use applicable to this Good.
2. **Programmable Products.** Seller shall not be responsible for the user's programming of a programmable Good, or any consequence thereof.
3. **Performance Data.** Performance data given in this catalog is provided as a guide for the user in determining suitability and does not constitute a warranty. It may represent the result of Seller's test conditions, and the user must correlate it to actual application requirements. Actual performance is subject to the Seller's Warranty and Limitations of Liability.
4. **Change in Specifications.** Product specifications and accessories may be changed at any time based on improvements and other reasons. It is our practice to change part numbers when published ratings or features are changed, or when significant construction changes are made. However, some specifications of the Good may be changed without any notice. When in doubt, special part numbers may be assigned to fix or establish key specifications for your application. Please consult with your Seller's representative at any time to confirm actual specifications of purchased Good.
5. **Errors and Omissions.** The information in this catalog has been carefully checked and is believed to be accurate; however, no responsibility is assumed for clerical, typographical or proofreading errors, or omissions.

NEVER USE THE PRODUCT FOR AN APPLICATION INVOLVING SERIOUS RISK TO LIFE OR PROPERTY WITHOUT ENSURING THAT THE SYSTEM AS A WHOLE HAS BEEN DESIGNED TO ADDRESS THE RISKS, AND THAT THE SELLER'S PRODUCT IS PROPERLY RATED AND INSTALLED FOR THE INTENDED USE WITHIN THE OVERALL EQUIPMENT OR SYSTEM.

Complete "Terms and Conditions of Sale" for product purchase and use are on Omron's website at www.omron.com/oei – under the "About Us" tab, in the Legal Matters section.

ALL DIMENSIONS SHOWN ARE IN MILLIMETERS.

To convert millimeters into inches, multiply by 0.03937. To convert grams into ounces, multiply by 0.03527.

OMRON[®]**OMRON ELECTRONICS LLC**

One Commerce Drive
Schaumburg, IL 60173

847-843-7900

For US technical support or other inquiries:

800-556-6766**OMRON CANADA, INC.**

885 Milner Avenue
Toronto, Ontario M1B 5V8

416-286-6465**OMRON ON-LINE**

Global - <http://www.omron.com>
USA - <http://www.omron.com/oei>
Canada - <http://www.omron.ca>