

The E32 Range is the Broadest Range of Standard and Special Purpose Fibre Sensors Stocked in the UK

All E3X amplifiers are compatible with all E32 fibres.

Ordering Information

Sensing method	Features	Order Number
Diffuse	Fibres are coaxially mounted within sensor head to give positional accuracy	E32-CC200
	General purpose type for large targets	E32-DC200
	General purpose type has needle head for large targets in confined space	E32-DC200B
	General purpose type for small targets	E32-DC200E
	General purpose type has needle head for small targets in confined space	E32-DC200F
	Long sensing distance type for large targets	E32-DC11L
	Long sensing distance type with side view sensing for large targets	E32-D14L
	Small sensor head with side view sensing for confined space	E32-D24
	General purpose type with coaxially mounted fibres in small head for accuracy	E32-D32*
	General purpose type with coaxially mounted fibres to give positional accuracy	E32-D32L
	Thin needle head gives detail detection	E32-D33
	High temperature detection type resists up to 300°C	E32-D61**
	Convergent spot type gives focused displacement accuracy	E32-L25
Retroreflective	General purpose type can detect transparent objects	E32-R16
	Small sensor head can detect transparent objects	E32-R21
Through-beam (sold in pairs)	General purpose type offers good sensing distance	E32-TC200
	General purpose type with fine needle had for small objects	E32-TC200F
	General purpose type with long sensing distance	E32-T11L
	Long sensing distance type has prism head for side viewing	E32-T14
	Long sensing distance type has thin head with side view	E32-T14L
	Special purpose type has 10 mm slit for wide target area	E32-T16
	Special purpose very long sensing distance type	E32-T17L
	Thin needle heads with side view for confined space	E32-T24
	High temperature type can withstand up to 300°C	E32-T61**
	Both emitter and receiver are divided into 4 heads to give AND/OR operation and wide cover	E32-M21**
	Slot type head has opposed emitter and receiver	E32-G14

* E39-F3A lens can be used with E32-D32 to increase positional accuracy and detail detection.

** The length cannot be trimmed.

Accessories (Order separately)

E39-F1
Lens kit

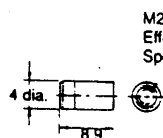

Lens (glass)

E39-F3A
Reflective Lens Unit (for the E32-D32)

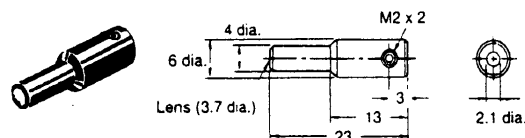

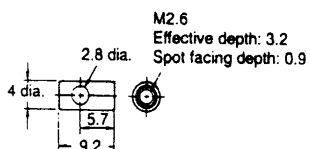

E39-F2
Side-view attachment

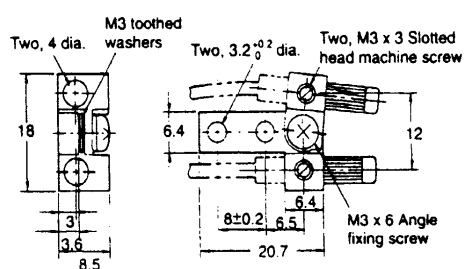

E39-F3
Convergent Beam Conversion Kit

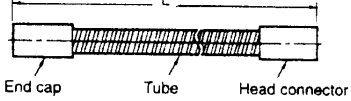

Name	Fibre Cutter	Fine-fibre Attachment	Fibre Connector*
Model	E39-F4	E39-F9	E39-F10
Appearance			
Features	Used to cut fibres to desired lengths	Used when inserting the fibres into the amp	Used to connect fibres to extend total length
Applicable fibre	All models equipped with trimmable fibres (cutter is included as standard with all trimmable fibres)	E32-DC200E, -TC200E E32-DC200F(4), -TC200F(4) E32-D21, -D21L, -D22L E32-T21, -T21L, -T22L E32-D32, -T22 E32-D24, -T24 E32-D33 *included with fibre E32-R21	E32-DC200, -TC200 E32-DC200B(4), -TC200B(4) E32-TC200A E32-T14, -G14 E32-D11L, -T11L, -T12L E32-D14L, -T14L E32-T17L

Name	Protective Spiral Tubes			
Model	E39-F32A	E39-F32B	E39-F32C	E39-F32D
Appearance				
Length	1000 mm			
Applicable fibre	E32-DC200E E32-DC200F(4) E32-D21	TC200E TC200F(4) E32-T21 E32-T21L	E32-TC200 E32-TC200B(4) E32-T11 E32-T51 E32-T11L	E32-DC200 E32-DC200B(4), E32-CC200 E32-D11L E32-D51 E32-D11L
Ambient temperature	Operating: -40°C to 150°C (do not exceed the operating temperature of the fibre)			
Ambient humidity	Operating: 35% to 85%			
Permissible bending radius	R: 30 mm min.			
Tensile strength	Between head connector and end cap with tube: 15 kgf • cm max. (1.5 N • m) Tube: 20 kgf • cm max. (2 N • m)			
Compression load	Tube: 3 kg max. (29.4 N)			

* OMRON does not sell fibre optic cable

Sensing Distances

■ Diffuse

Fibre Model	Sensing Distance with:				
	Amplifier Type 'A'	Amplifier Type 'F'	Amplifier Type 'H'	Amplifier Type 'T'	Amplifier 'VG'
E32-CC200	75 mm	33 mm	150 mm	100 mm	10 mm
E32-DC200	75 mm	33 mm	150 mm	100 mm	10 mm
E32-DC200B	75 mm	33 mm	150 mm	100 mm	10 mm
E32-DC200E	18 mm	8 mm	36 mm	20 mm	2 mm
E32-DC200F	18 mm	8 mm	36 mm	20 mm	2 mm
E32-D11L	100 mm	45 mm	200 mm	150 mm	10 mm
E32-D14L	40 mm	12 mm	40 mm	40 mm	1.5 mm
E32-D24	15 mm	4 mm	15 mm	15 mm	1.6 mm
E32-D32	20 mm	9 mm	40 mm	30 mm	2.5 mm
E32-D32L	40 mm	11 mm	80 mm	60 mm	4 mm
E32-D33	5 mm	1.8mm	10 mm	6 mm	-
E32-D61	45 mm slot width	20 mm	45 mm	45 mm	5 mm
E32-L25	3.3 mm (convergent slot)				

■ Retroreflective

E32-R16	150 TO 1500 mm	50 to 700 mm	150 to 1500 mm	150 to 1500 mm	-
E32-R21	10 to 250 mm	20 to 230 mm	10 to 250 mm	25 to 250 mm	-

■ Through-beam

E32-TC200	200 mm (1500 mm)*	80 mm	400 mm (3000 mm)*	270 mm (2000 mm)*	28 mm (190 mm)*
E32-TC200F	50 mm	26 mm	100 mm	70 mm	8 mm
E32-T11L	350 mm (1000 mm)*	150 mm	700 mm (2000 mm)*	500 mm (1200 mm)*	40 mm (120 mm)*
E32-T14	900 mm	380 mm	1800 mm	1000 mm	80 mm
E32-T14L	120 mm	30 mm	240 mm	130 mm	10 mm
E32-T16	750 mm	330 mm	1500 mm	1000 mm	150 mm
E32-T17L	7000 mm	3000 mm	14000 mm	7000 mm	800 mm
E32-T24	45 mm	15 mm	90 mm	45 mm	2 mm
E32-T61	150 mm	60 mm	300 mm	180 mm	18 mm
E32-M21	150 mm	65 mm	300 mm	200 mm	20 mm
E32-G14	10 mm slot width				

* With E39-F1 lens kit

Dimensions

■ Diffuse Reflective

E32-CC200

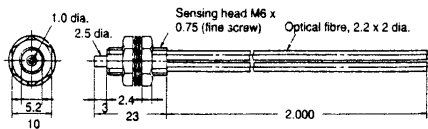

E32-DC200

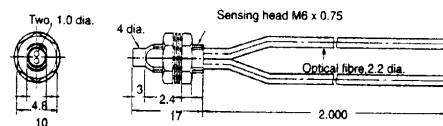

E32-DC200B

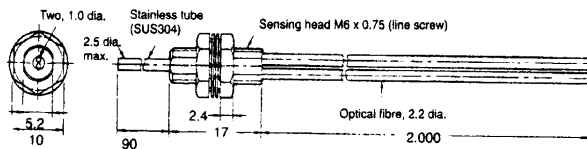

E32-DC200E

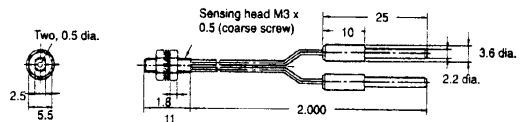

E32-DC200F

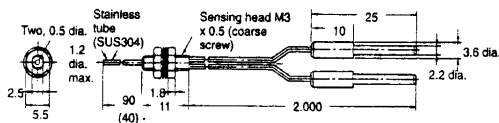

E32-D11L

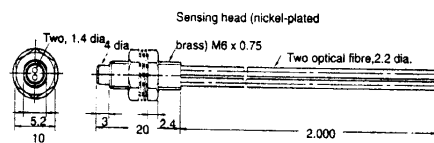

E32-D14L

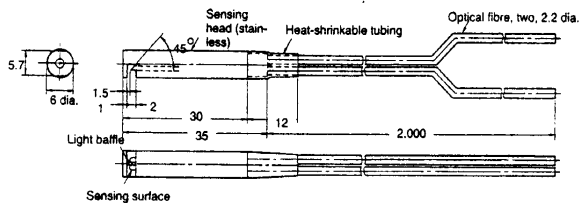

E32-D24

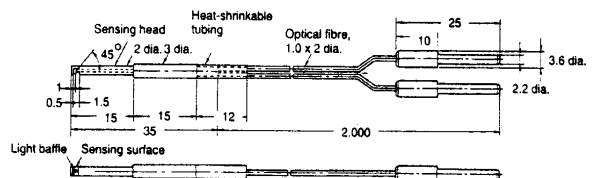

E32-D32

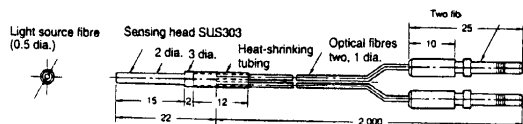

Note: The fibre for the light source is identified by a white line

E32-D32L

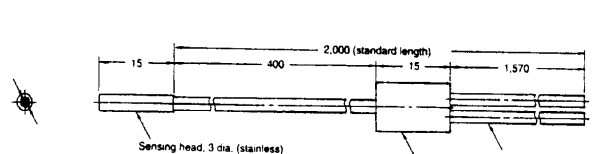

Note: The fibre for the light source is identified by a yellow dotted line

E32-D33

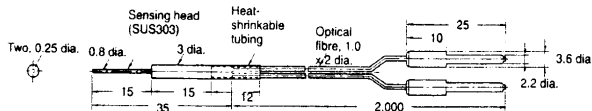

E32-D61

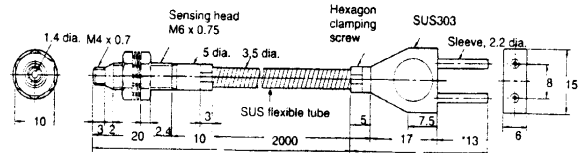

E32-L25

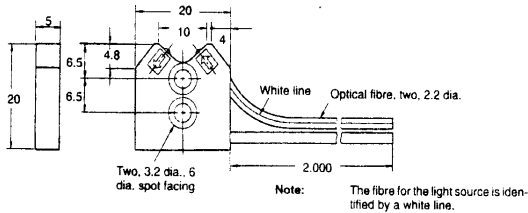

■ Retroreflective

E32-R16 (supplied with reflector E39-R1)

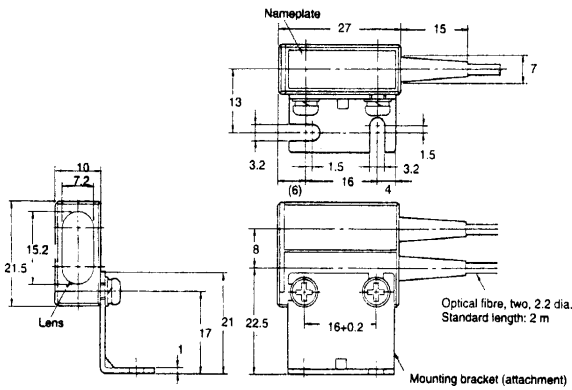

E32-R21 (supplied with reflector E39-R3)

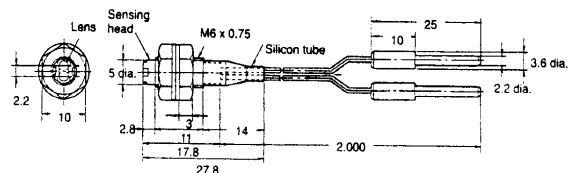

Note: For dimensions of reflectors supplied with E32-R16 and E32-R21, please refer to separate entry for Reflectors at the end of this section.

■ Through-beam

E32-TC200

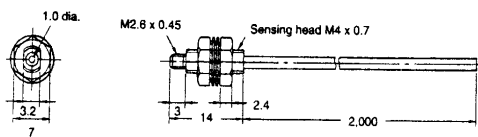

E32-TC200F

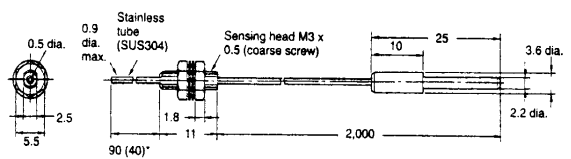

E32-T11L

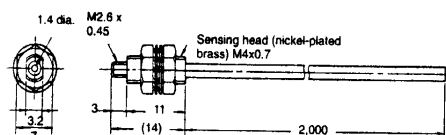

E32-T14

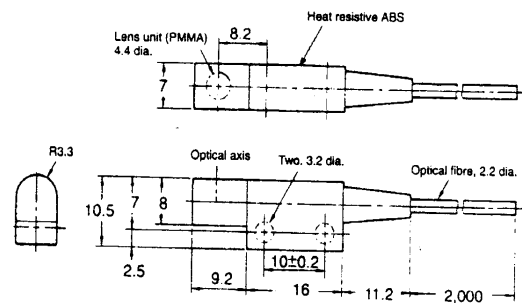

E32-T14L

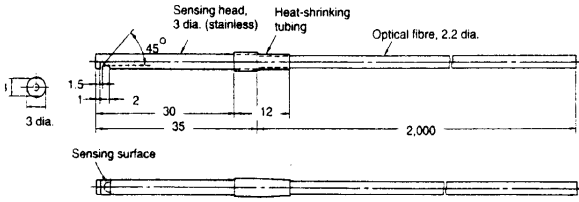

E32-T16

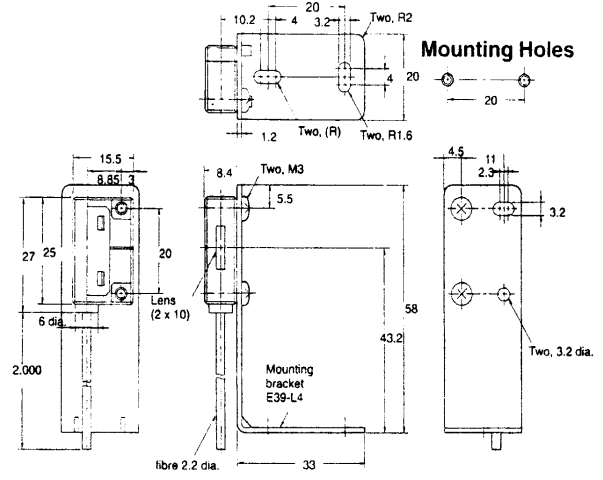

E32-T17L

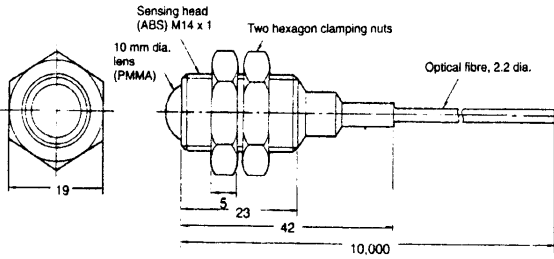

E32-T24

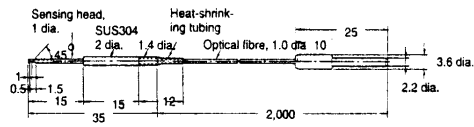

E32-T61

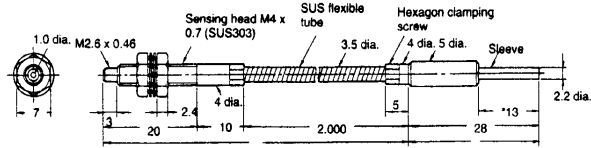

Note: Section A resists 300°C and Section B (which is inserted to the amplifier) resists 110°C. The operating temperature of section B must also be within the withstand temperature range of the amplifier.

E32-M21

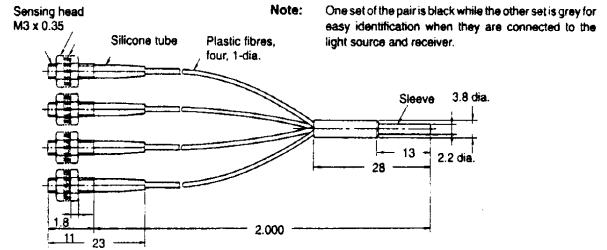

E32-G14

