

ROHM's Selection Operational Amplifier/Comparator Series



# Operational Amplifiers: High Voltage CMOS

• Input-Output Full Swing

**BD7561G, BD7561SG, BD7541G, BD7541SG,**

**BD7562F/FVM, BD7562S F/FVM, BD7542F/FVM, BD7542S F/FVM**

### ● Description

High voltage operable CMOS Op-Amp BD7561/BD7541 family and BD7562/BD7542 family

Integrate one or two independent input-output full swing Op-amps and phase compensation capacitors on a single chip.

Especially, characteristics are wide operating voltage range of +5[V]~+14.5[V](single power supply), low supply current and little input bias current.

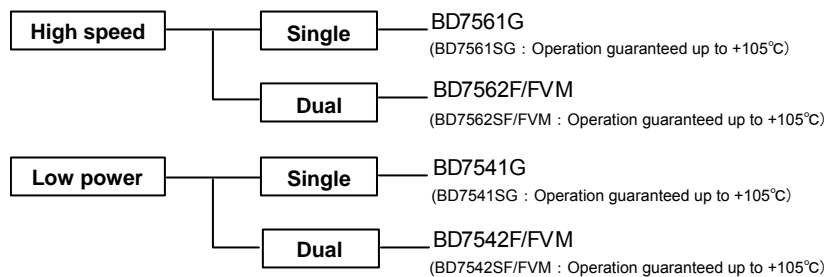

### ● Characteristics

- Wide operating supply voltage(+5[V]~ +14.5[V])
- +5[V]~ +14.5[V](single supply)  
±2.5[V]~±7.25[V](split supply)
- Input and Output full swing
- Internal phase compensation
- High slew rate (BD7561 family, BD7562 family)
- Low supply current (BD7541 family, BD7542 family)
- High large signal voltage gain
- Internal ESD protection  
Human body model (HBM) ±4000[V](Typ.)
- Wide temperature range  
-40[°C]~ +85[°C]  
(BD7561G, BD7562 family, BD7541G, BD7542 family)  
-40[°C]~ +105[°C]  
(BD7561SG, BD7562S family, BD7541SG, BD7542S family)

### ● Pin Assignment

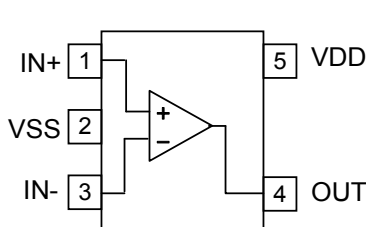

**SSOP5**

BD7561G  
BD7561SG  
BD7541G  
BD7541SG

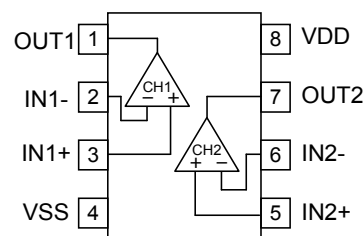

**SOP8**

BD7562F  
BD7562SF  
BD7542F  
BD7542SF

**MSOP8**

BD7562FVM  
BD7562SFVM  
BD7542FVM  
BD7542SFVM

● Absolute Maximum Ratings (Ta=25[°C])

Parameter	Symbol	Rating		Unit
		BD7561G, BD7562 F/FVM BD7541G, BD7542 F/FVM	BD7561SG, BD7562S F/FVM BD7541SG, BD7542S F/FVM	
Supply Voltage	VDD-VSS	+ 15.5		V
Differential Input Voltage(*1)	Vid	VDD-VSS		V
Input Common-mode Voltage Range	Vicm	(VSS - 0.3) ~ (VDD + 0.3)		V
Operating Temperature	Topr	- 40 ~ + 85	- 40 ~ + 105	°C
Storage Temperature	Tstg	- 55 ~ + 125		°C
Maximum Junction Temperature	Tjmax	+ 125		°C

Note: Absolute maximum rating item indicates the condition which must not be exceeded.

Application of voltage in excess of absolute maximum rating or use out absolute maximum rated temperature environment may cause deterioration of characteristics.

(\*1) The voltage difference between inverting input and non-inverting input is the differential input voltage. Then input terminal voltage is set to more than VSS.

● Electric Characteristics

○ BD7561 family, BD7562 family (Unless otherwise specified VDD=+12[V], VSS=0[V], Ta=25[°C])

Parameter	Symbol	Temperature range	Guaranteed limit						Unit	Condition
			BD7561G BD7561SG			BD7562 F/FVM BD7562S F/FVM				
			Min.	Typ.	Max.	Min.	Typ.	Max.		
Input Offset Voltage (*2)(*4)	Vio	25°C	-	1	9	-	1	9	mV	VDD=5~14.5[V], VOUT=VDD/2
		Full range	-	-	10	-	-	10		
Input Offset Current (*2)	Iio	25°C	-	1	-	-	1	-	pA	-
Input Bias Current (*2)	Ib	25°C	-	1	-	-	1	-	pA	-
Supply Current (*4)	IDD	25°C	-	370	550	-	750	1300	µA	RL=∞ All Op-Amps AV=0[dB], VDD=5[V], VIN=2.5[V] RL=∞ All Op-Amps AV=0[dB], VDD=12[V], VIN=6.0[V]
		Full range	-	-	600	-	-	1500		
		25°C	-	440	650	-	900	1400		
		Full range	-	-	700	-	-	1600		
High Level Output Voltage	VOH	25°C	VDD-0.1	-	-	VDD-0.1	-	-	V	RL=10[kΩ]
Low Level Output Voltage	VOL	25°C	-	-	VSS+0.1	-	-	VSS+0.1	V	RL=10[kΩ]
Large Single Voltage Gain	AV	25°C	70	95	-	70	95	-	dB	RL=10[kΩ]
Input Common-mode Voltage Range	Vicm	25°C	0	-	12	0	-	12	V	VDD-VSS=12[V]
Common-mode Rejection Ratio	CMRR	25°C	45	60	-	45	60	-	dB	-
Power Supply Rejection Ratio	PSRR	25°C	60	80	-	60	80	-	dB	-
Output Source Current (*3)	IOH	25°C	3	8	-	3	8	-	mA	VDD-0.4[V]
Output Sink Current (*3)	IOL	25°C	4	14	-	4	14	-	mA	VSS+0.4[V]
Slew Rate	SR	25°C	-	0.9	-	-	0.9	-	V/µs	CL=25[pF]
Gain Bandwidth Product	FT	25°C	-	1.0	-	-	1.0	-	MHz	CL=25[pF], AV=40[dB]
Phase Margin	θ	25°C	-	50°	-	-	50°	-	-	CL=25[pF], AV=40[dB]
Total Harmonic Distortion	THD	25°C	-	0.05	-	-	0.05	-	%	VOUT=1[Vp-p], f=1[kHz]

(\*2) Absolute value

(\*3) Under the high temperature environment, consider the power dissipation of IC when selecting the output current.

When the terminal short circuits are continuously output, the output current is reduced to climb to the temperature inside IC.

(\*4) Full range : BD7561, BD7562 : Ta=40[°C]~+85[°C] BD7561S, BD7562S : Ta=-40[°C]~+105[°C]

● Electric Characteristics

○ BD7541 family, BD7542 family (Unless otherwise specified VDD=+12[V], VSS=0[V], Ta=25[°C])

Parameter	Symbol	Temperature range	Guaranteed limit						Unit	Condition
			BD7541G BD7541SG			BD7542 F/FVM BD7542S F/FVM				
			Min.	Typ.	Max.	Min.	Typ.	Max.		
Input Offset Voltage (*5)(*7)	Vio	25°C	-	1	9	-	1	9	mV	VDD=5~14.5[V], VOUT=VDD/2
		Full range	-	-	10	-	-	10		
Input Offset Current (*5)	Iio	25°C	-	1	-	-	1	-	pA	-
Input Bias Current (*5)	Ib	25°C	-	1	-	-	1	-	pA	-
Supply Current (*7)	IDD	25°C	-	170	300	-	340	650	µA	RL=∞ All Op-Amps AV=0[dB], VDD=5[V], VIN=2.5[V] RL=∞ All Op-Amps AV=0[dB], VDD=12[V], VIN=6.0[V]
		Full range	-	-	400	-	-	850		
		25°C	-	180	320	-	400	780		
		Full range	-	-	420	-	-	900		
High Level Output Voltage	VOH	25°C	VDD-0.1	-	-	VDD-0.1	-	-	V	RL=10[kΩ]
Low Level Output Voltage	VOL	25°C	-	-	VSS+0.1	-	-	VSS+0.1	V	RL=10[kΩ]
Large Single Voltage Gain	AV	25°C	70	95	-	70	95	-	dB	RL=10[kΩ]
Input Common-mode Voltage Range	Vicm	25°C	0	-	12	0	-	12	V	VDD-VSS=12[V]
Common-mode Rejection Ratio	CMRR	25°C	45	60	-	45	60	-	dB	-
Power Supply Rejection Ratio	PSRR	25°C	60	80	-	60	80	-	dB	-
Output Source Current (*6)	IOH	25°C	2	4	-	2	4	-	mA	VDD-0.4[V]
Output Sink Current (*6)	IOL	25°C	3	7	-	3	7	-	mA	VSS+0.4[V]
Slew Rate	SR	25°C	-	0.3	-	-	0.3	-	V/µs	CL=25[pF]
Gain Bandwidth Product	FT	25°C	-	0.6	-	-	0.6	-	MHz	CL=25[pF], AV=40[dB]
Phase Margin	θ	25°C	-	50°	-	-	50°	-	-	CL=25[pF], AV=40[dB]
Total Harmonic Distortion	THD	25°C	-	0.05	-	-	0.05	-	%	VOUT=1[Vp-p], f=1[kHz]

(\*5) Absolute value

(\*6) Under the high temperature environment, consider the power dissipation of IC when selecting the output current.

When the terminal short circuits are continuously output, the output current is reduced to climb to the temperature inside IC.

(\*7) Full range : BD7541, BD7542 : Ta=40[°C]~+85[°C] BD7541S, BD7542S : Ta=-40[°C]~+105[°C]

● Example of electrical characteristics  
○ BD7561 family

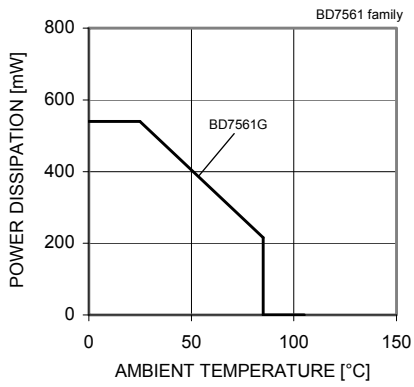

Fig.1 Derating Curve

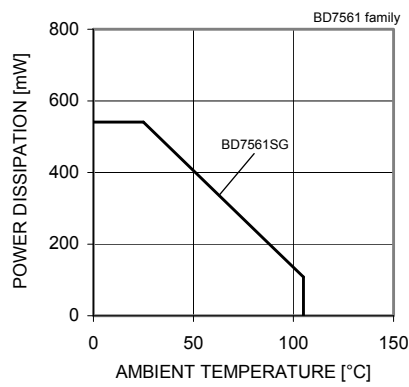

Fig.2 Derating Curve

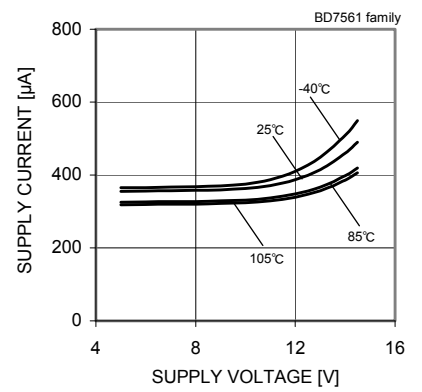

Fig.3 Supply Current – Supply Voltage

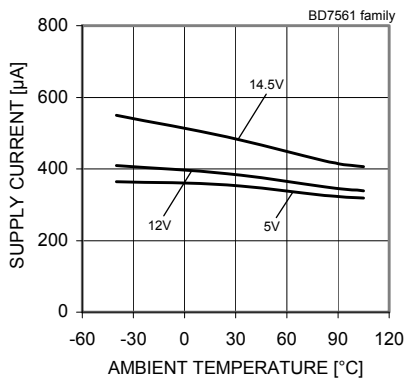

Fig.4 Supply Current – Ambient Temperature

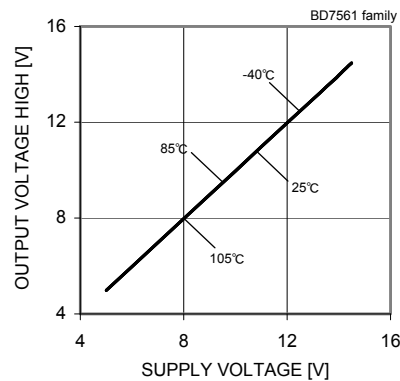

Fig.5 Output Voltage High – Supply Voltage (RL=10[kΩ])

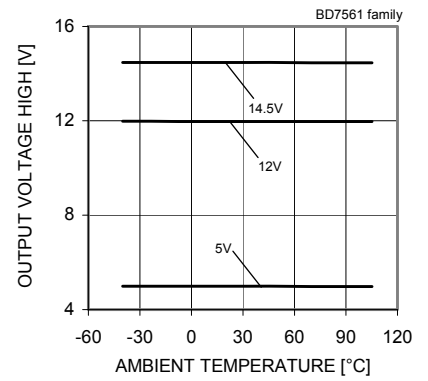

Fig.6 Output Voltage High – Ambient Temperature (RL=10[kΩ])

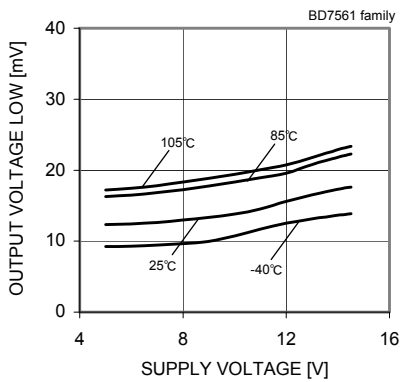

Fig.7 Output Voltage Low – Supply Voltage (RL=10[kΩ])

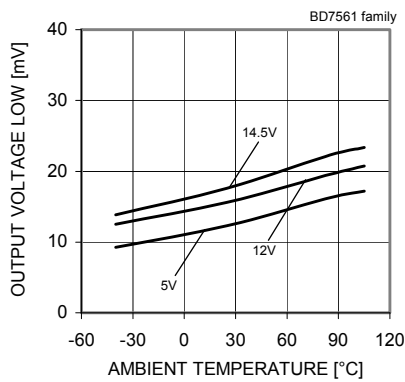

Fig.8 Output Voltage Low – Ambient Temperature (RL=10[kΩ])

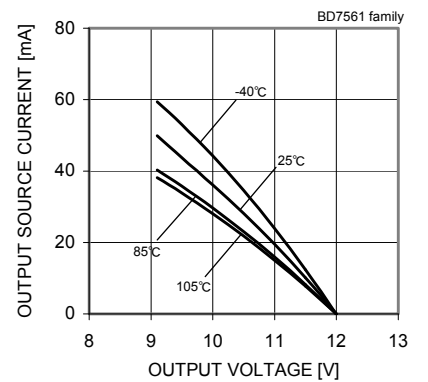

Fig.9 Output Source Current – Output Voltage (VDD=12[V])

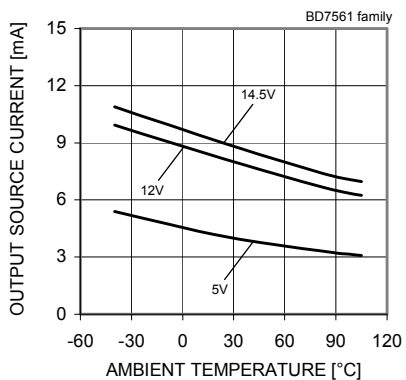

Fig.10 Output Source Current – Ambient Temperature (VOUT=VDD-0.4[V])

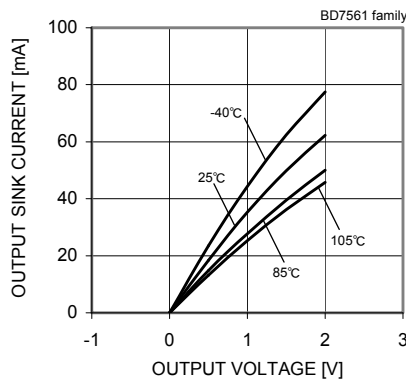

Fig.11 Output Sink Current – Output Voltage (VDD=12[V])

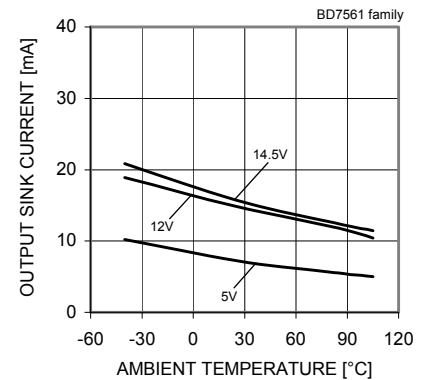

Fig.12 Output Sink Current – Ambient Temperature (VOUT=VDD-11.6[V])

(\* )The above data is ability value of sample, it is not guaranteed. BD7561 : -40[°C]~+85[°C] BD7561S : -40[°C]~+105[°C]

○BD7561 family

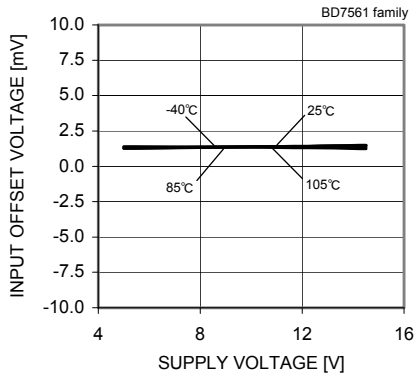

Fig.13  
Input Offset Voltage – Supply Voltage  
( $V_{icm}=V_{DD}$ ,  $V_{OUT}=V_{DD}/2$ )

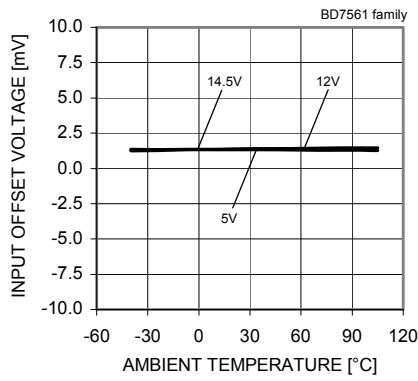

Fig.14  
Input Offset Voltage – Ambient Temperature  
( $V_{icm}=V_{DD}$ ,  $V_{OUT}=V_{DD}/2$ )

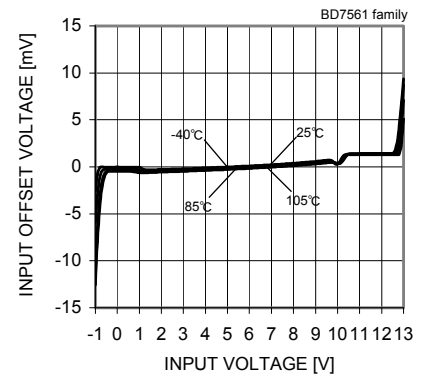

Fig.15  
Input Offset Voltage – Input Voltage  
( $V_{DD}=12[V]$ )

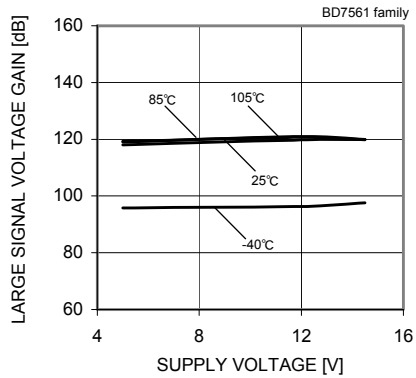

Fig.16  
Large Signal Voltage Gain  
– Supply Voltage

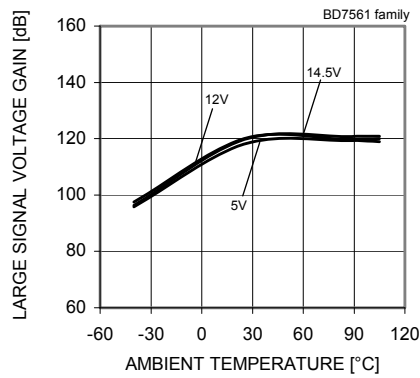

Fig.17  
Large Signal Voltage Gain  
– Ambient Temperature

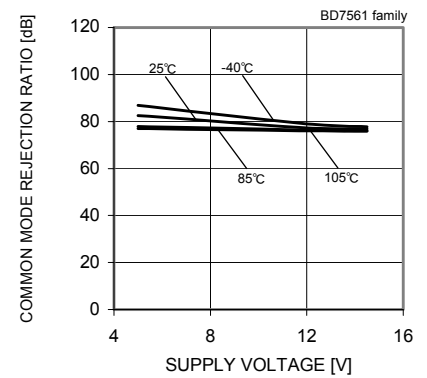

Fig.18  
Common Mode Rejection Ratio  
– Supply Voltage  
( $V_{DD}=12[V]$ )

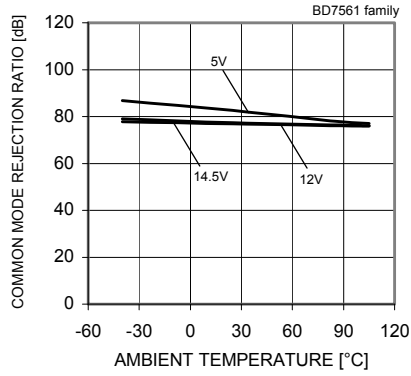

Fig.19  
Common Mode Rejection Ratio  
– Ambient Temperature  
( $V_{DD}=12[V]$ )

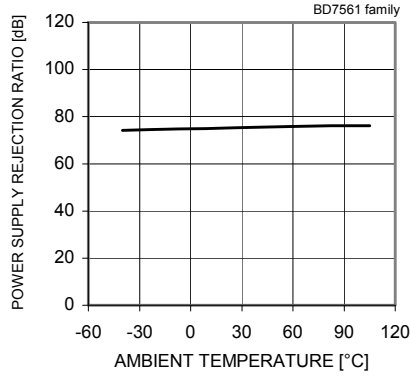

Fig.20  
Power Supply Rejection Ratio  
– Ambient Temperature

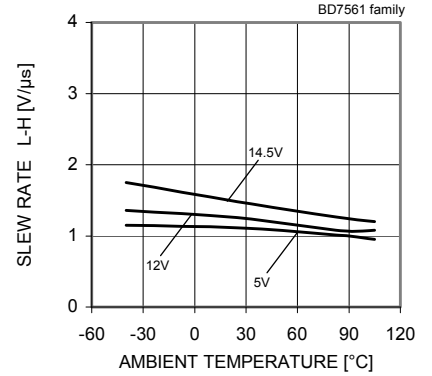

Fig.21  
Slew Rate L-H – Ambient Temperature

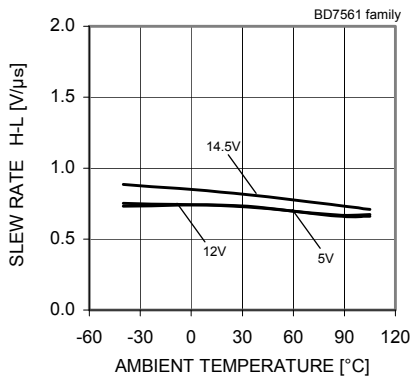

Fig.22  
Slew Rate H-L – Ambient  
Temperature

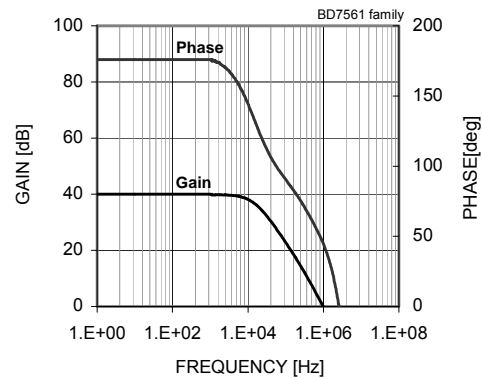

Fig.23  
Gain - Frequency

(\* )The above data is ability value of sample, it is not guaranteed. BD7561 : -40[°C]~+85[°C] BD7561S : -40[°C]~+105[°C]

● Example of electrical characteristics  
○ BD7562 family

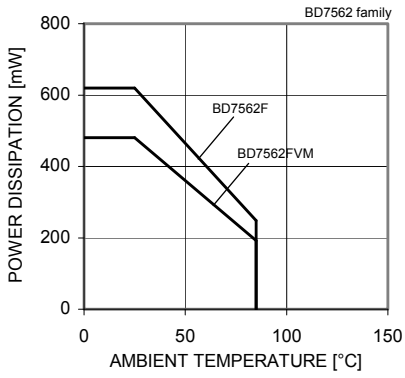

Fig.1  
Derating Curve

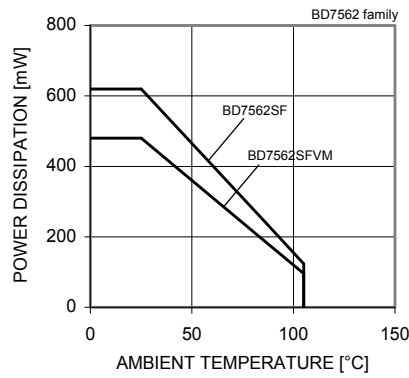

Fig.2  
Derating Curve

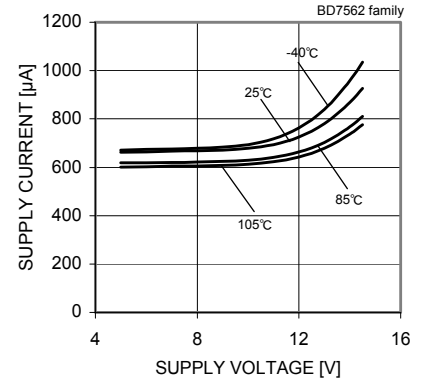

Fig.3  
Supply Current – Supply Voltage

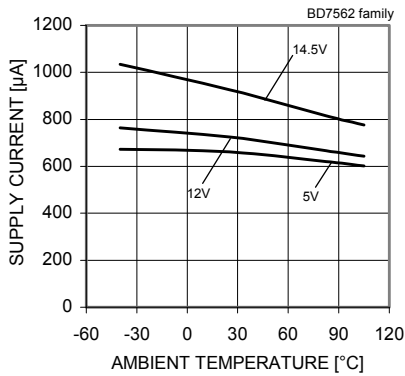

Fig.4  
Supply Current – Ambient Temperature

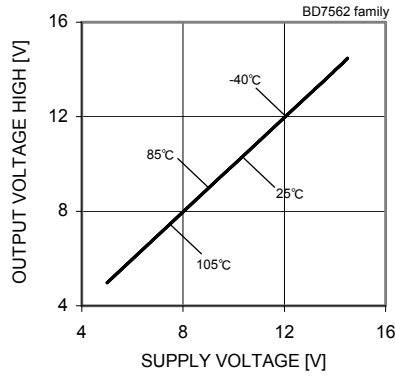

Fig.5  
Output Voltage High – Supply Voltage  
(RL=10[kΩ])

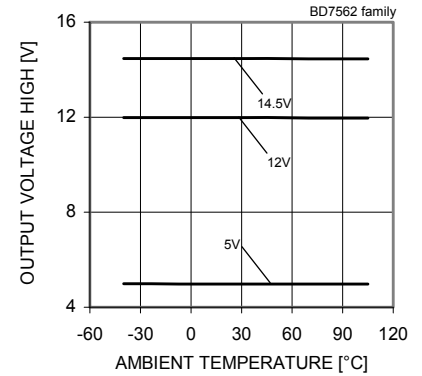

Fig.6  
Output Voltage High – Ambient Temperature  
(RL=10[kΩ])

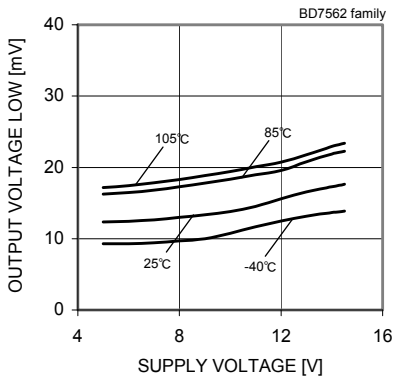

Fig.7  
Output Voltage Low – Supply Voltage  
(RL=10[kΩ])

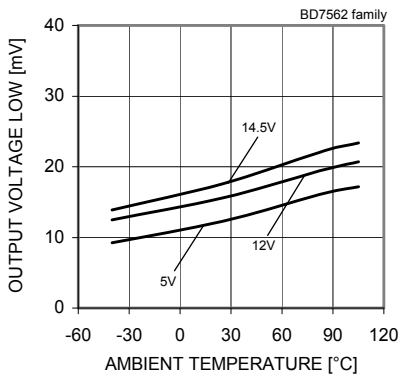

Fig.8  
Output Voltage Low – Ambient Temperature  
(RL=10[kΩ])

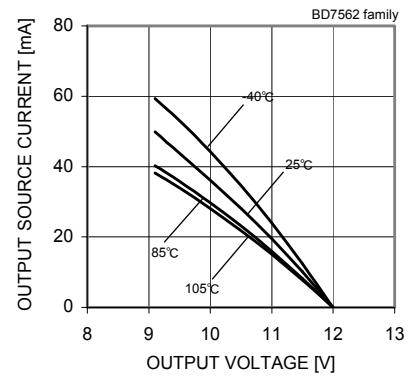

Fig.9  
Output Source Current – Output Voltage  
(VDD=12[V])

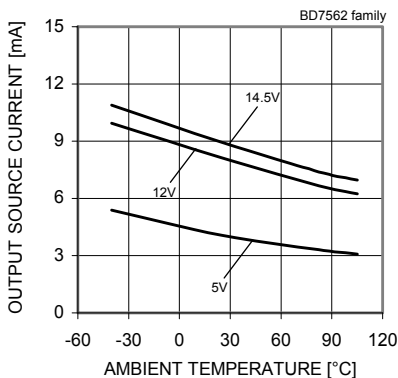

Fig.10  
Output Source Current – Ambient Temperature  
(VOUT=VDD-0.4[V])

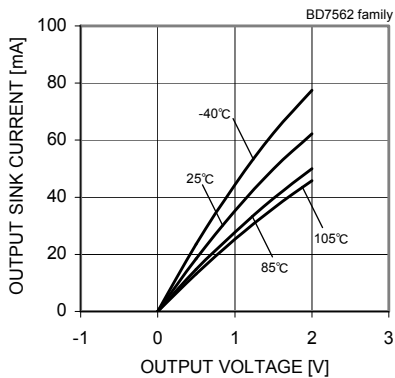

Fig.11  
Output Sink Current – Output Voltage  
(VDD=12[V])

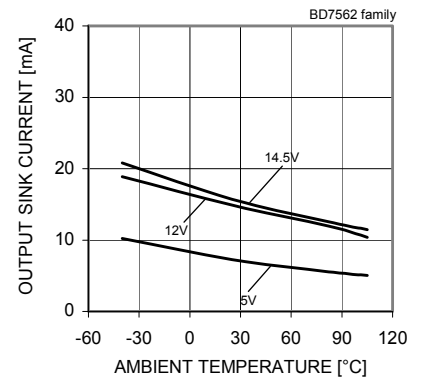

Fig.12  
Output Sink Current – Ambient Temperature  
(VOUT=VDD-11.6[V])

(\* )The above data is ability value of sample, it is not guaranteed. BD7562 : -40[°C]~+85[°C] BD7562S : -40[°C]~+105[°C]

○BD7562 family

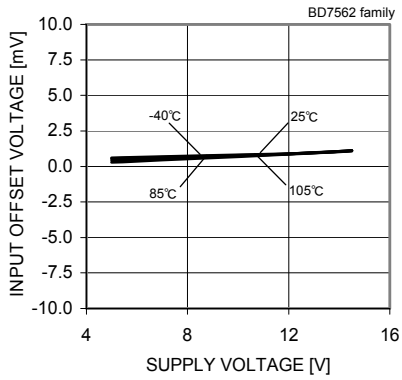

Fig.13  
Input Offset Voltage – Supply Voltage  
( $V_{icm}=V_{DD}$ ,  $V_{OUT}=V_{DD}/2$ )

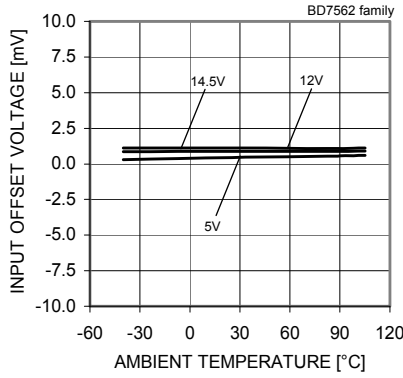

Fig.14  
Input Offset Voltage – Ambient Temperature  
( $V_{icm}=V_{DD}$ ,  $V_{OUT}=V_{DD}/2$ )

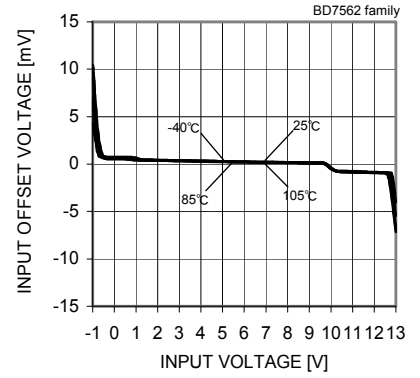

Fig.15  
Input Offset Voltage – Input Voltage  
( $V_{DD}=12[V]$ )

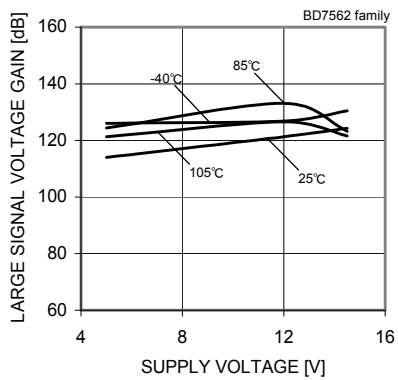

Fig.16  
Large Signal Voltage Gain  
– Supply Voltage

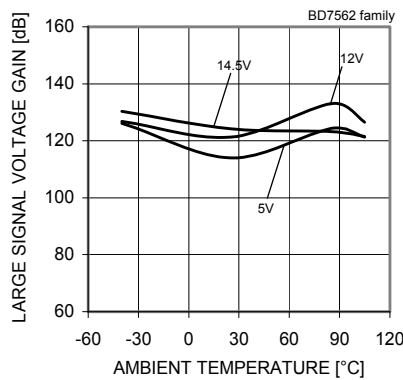

Fig.17  
Large Signal Voltage Gain  
– Ambient Temperature

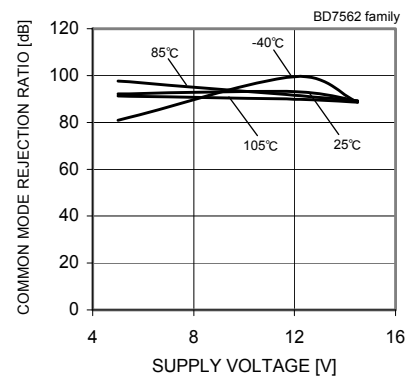

Fig.18  
Common Mode Rejection Ratio  
– Supply Voltage  
( $V_{DD}=12[V]$ )

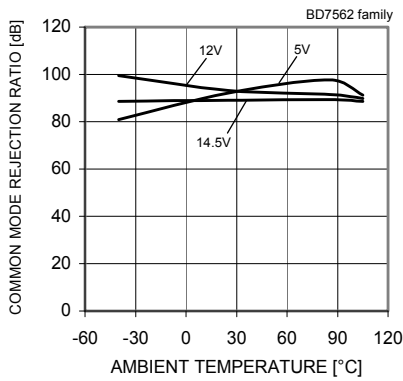

Fig.19  
Common Mode Rejection Ratio  
– Ambient Temperature  
( $V_{DD}=12[V]$ )

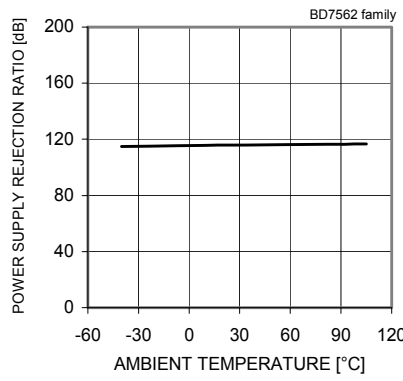

Fig.20  
Power Supply Rejection Ratio  
– Ambient Temperature

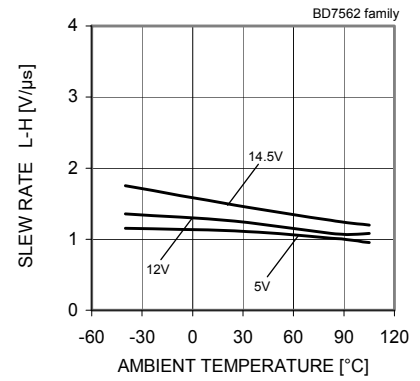

Fig.21  
Slew Rate L-H – Ambient Temperature

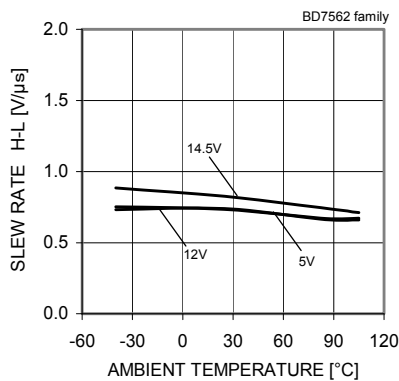

Fig.22  
Slew Rate H-L – Ambient  
Temperature

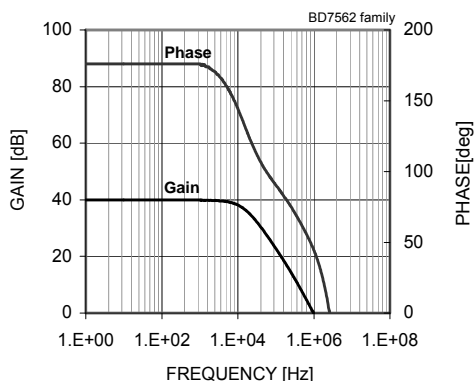

Fig.23  
Gain - Frequency

(\* )The above data is ability value of sample, it is not guaranteed. BD7562 : -40[°C]~+85[°C] BD7562S : -40[°C]~+105[°C]

● Example of electrical characteristics

○ BD7541 family

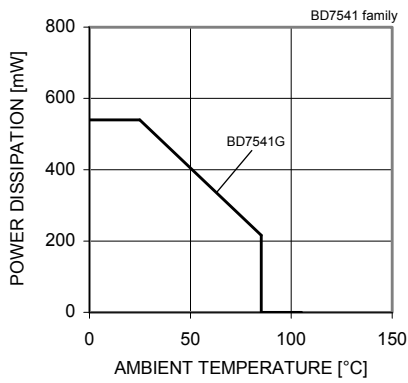

Fig.1 Derating Curve

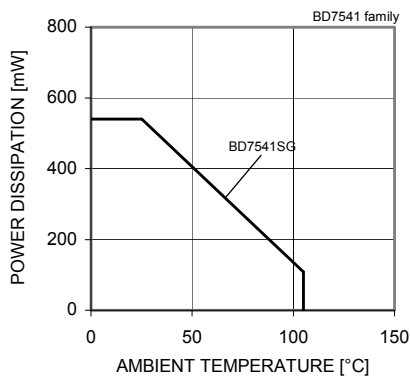

Fig.2 Derating Curve

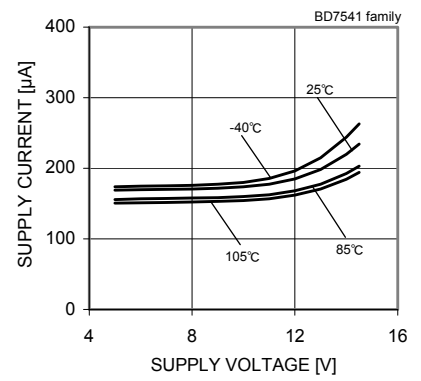

Fig.3 Supply Current - Supply Voltage

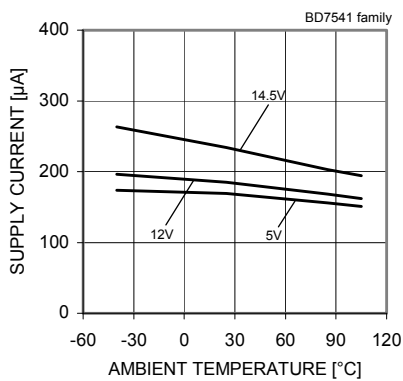

Fig.4 Supply Current - Ambient Temperature

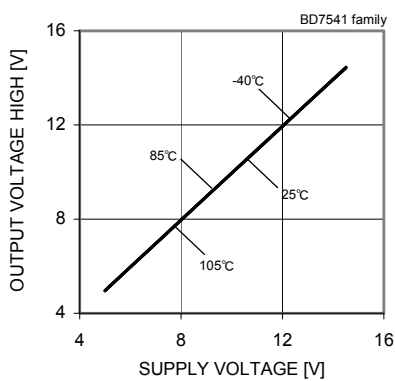

Fig.5 Output Voltage High - Supply Voltage (RL=10[kΩ])

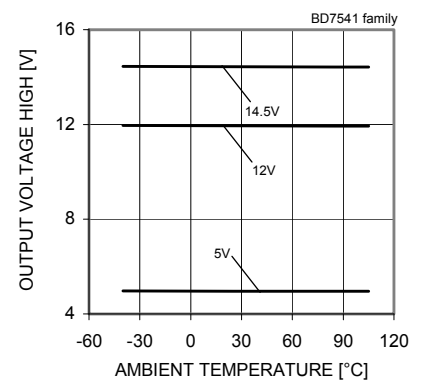

Fig.6 Output Voltage High - Ambient Temperature (RL=10[kΩ])

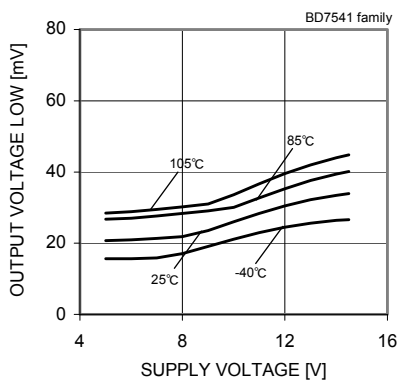

Fig.7 Output Voltage Low - Supply Voltage (RL=10[kΩ])

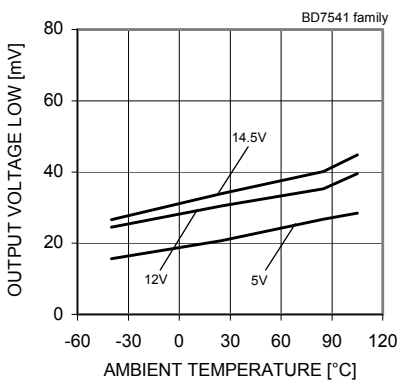

Fig.8 Output Voltage Low - Ambient Temperature (RL=10[kΩ])

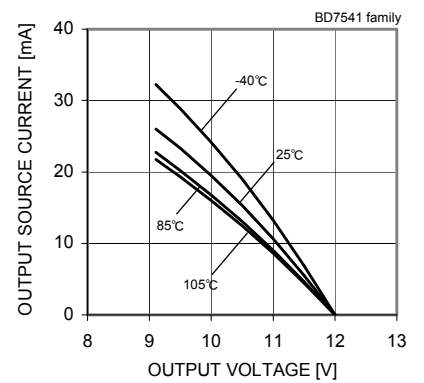

Fig.9 Output Source Current - Output Voltage (VDD=12[V])

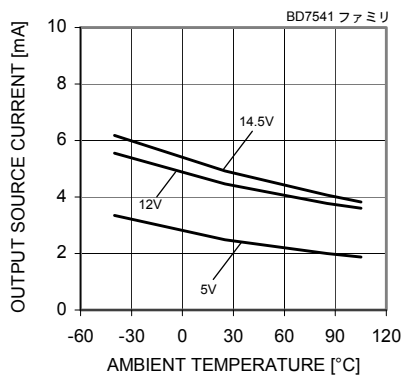

Fig.10 Output Source Current - Ambient Temperature (VOUT=VDD-0.4[V])

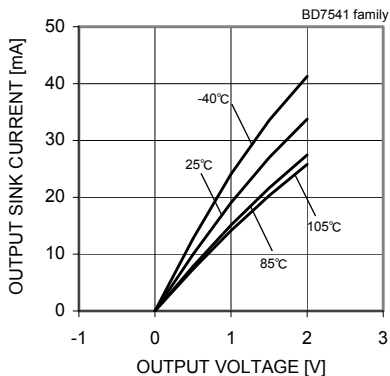

Fig.11 Output Sink Current - Output Voltage (VDD=12[V])

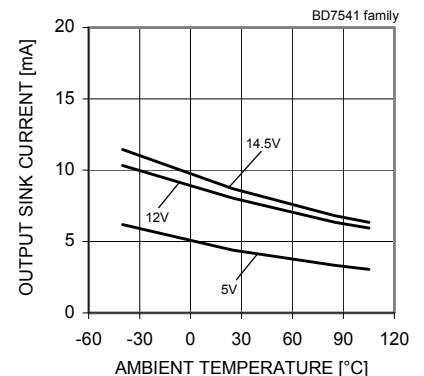

Fig.12 Output Sink Current - Ambient Temperature (VOUT=VDD-11.6[V])

(\* )The above data is ability value of sample, it is not guaranteed. BD7541 : -40[°C]~+85[°C] BD7541S : -40[°C]~+105[°C]

○BD7541 family

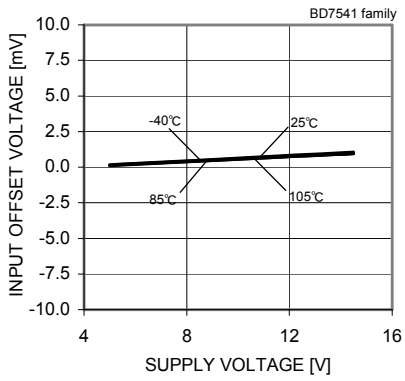

Fig. 13  
Input Offset Voltage – Supply Voltage  
( $V_{icm}=V_{DD}$ ,  $V_{OUT}=V_{DD}/2$ )

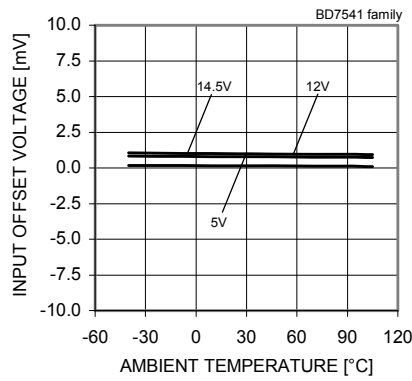

Fig. 14  
Input Offset Voltage – Ambient Temperature  
( $V_{icm}=V_{DD}$ ,  $V_{OUT}=V_{DD}/2$ )

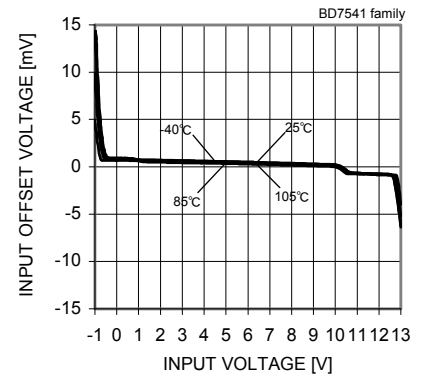

Fig. 15  
Input Offset Voltage – Input Voltage  
( $V_{DD}=12[V]$ )

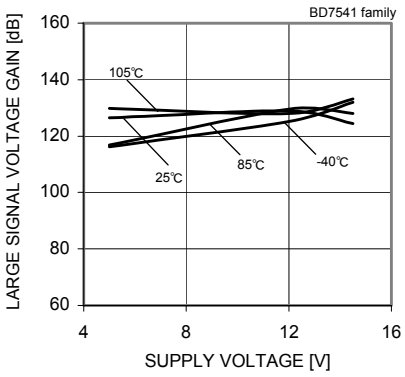

Fig. 16  
Large Signal Voltage Gain  
– Supply Voltage

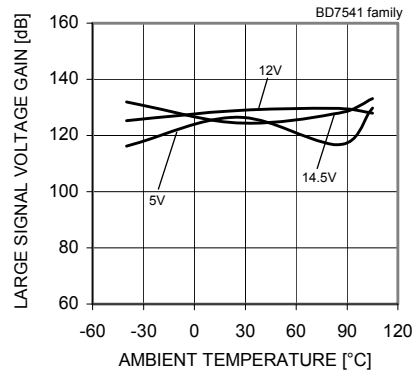

Fig. 17  
Large Signal Voltage Gain  
– Ambient Temperature

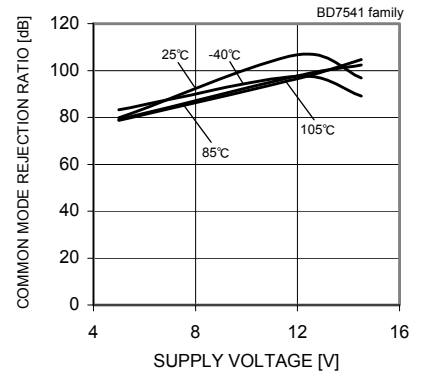

Fig. 18  
Common Mode Rejection Ratio  
– Supply Voltage  
( $V_{DD}=12[V]$ )

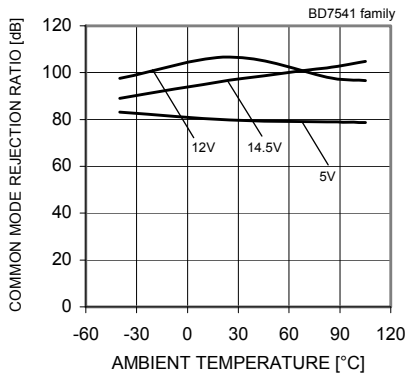

Fig. 19  
Common Mode Rejection Ratio  
– Ambient Temperature  
( $V_{DD}=12[V]$ )

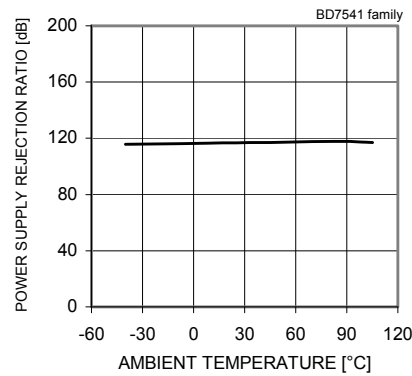

Fig. 20  
Power Supply Rejection Ratio  
– Ambient Temperature

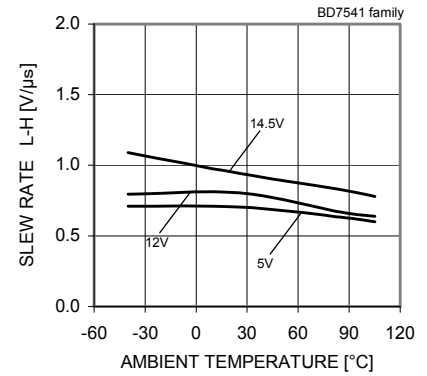

Fig. 21  
Slew Rate L-H – Ambient Temperature

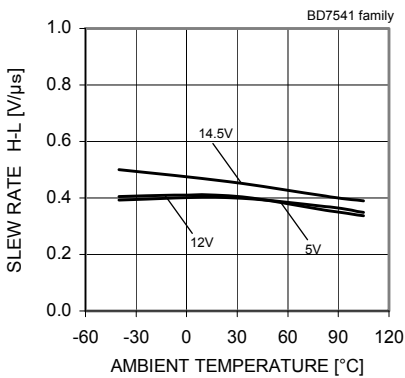

Fig. 22  
Slew Rate H-L – Ambient Temperature

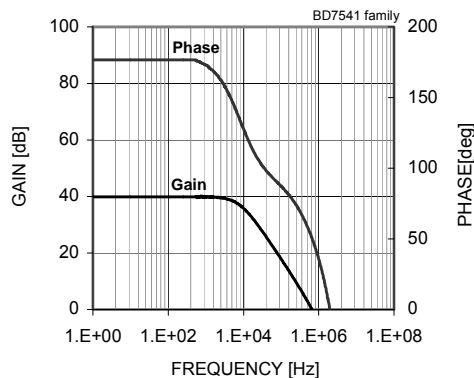

Fig. 23  
Gain - Frequency

(\* )The above data is ability value of sample, it is not guaranteed. BD7541 : -40[°C]~+85[°C] BD7541S : -40[°C]~+105[°C]



● Example of electrical characteristics  
○ BD7542 family

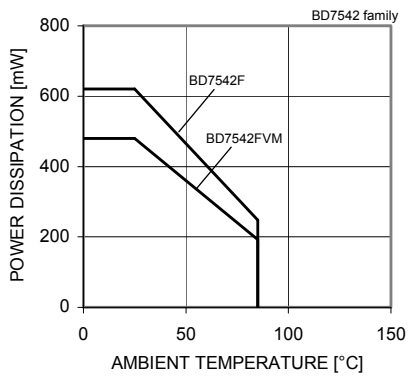

Fig.1  
Derating Curve

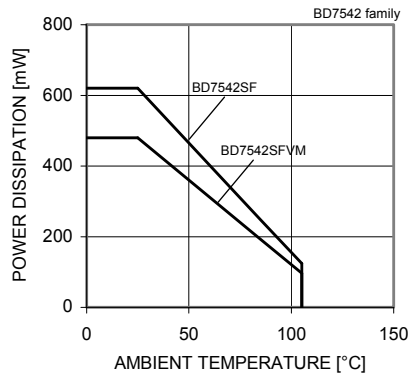

Fig.2  
Derating Curve

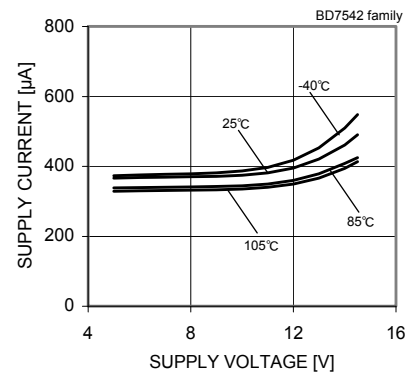

Fig.3  
Supply Current - Supply Voltage

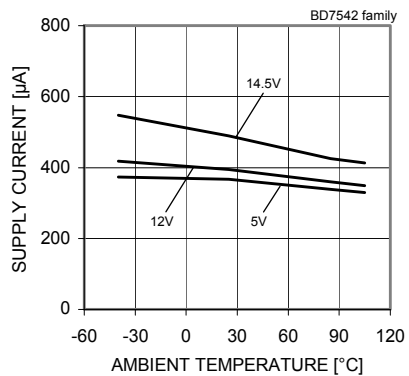

Fig.4  
Supply Current - Ambient Temperature

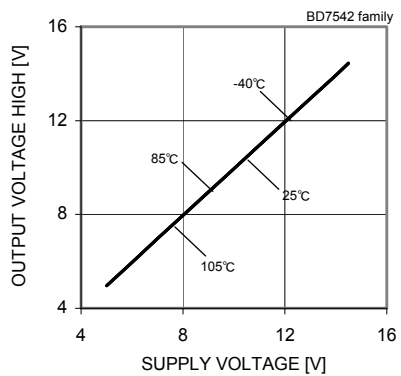

Fig.5  
Output Voltage High - Supply Voltage  
( $R_L=10[k\Omega]$ )

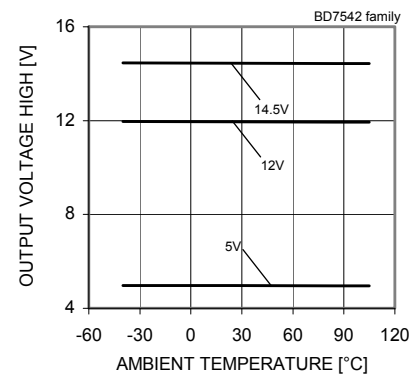

Fig.6  
Output Voltage High - Ambient Temperature  
( $R_L=10[k\Omega]$ )

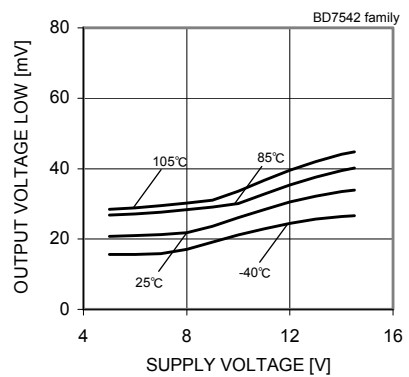

Fig.7  
Output Voltage Low - Supply Voltage  
( $R_L=10[k\Omega]$ )

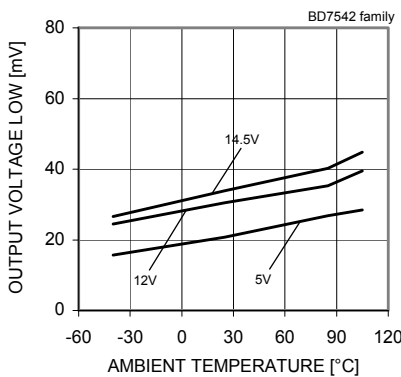

Fig.8  
Output Voltage Low - Ambient Temperature  
( $R_L=10[k\Omega]$ )

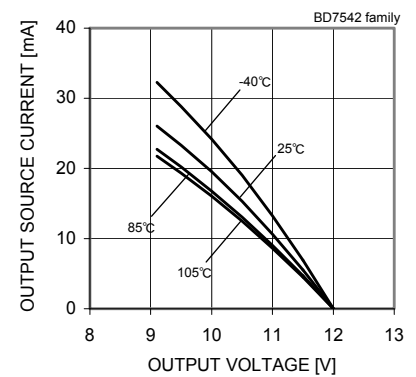

Fig.9  
Output Source Current - Output Voltage  
( $V_{DD}=12[V]$ )

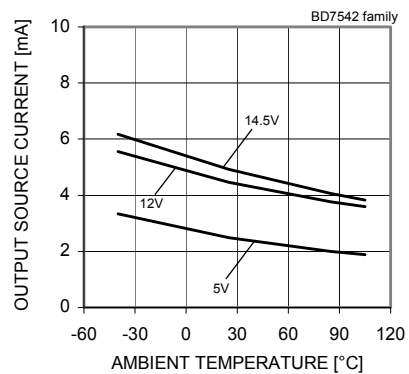

Fig.10  
Output Source Current - Ambient Temperature  
( $V_{OUT}=V_{DD}-0.4[V]$ )

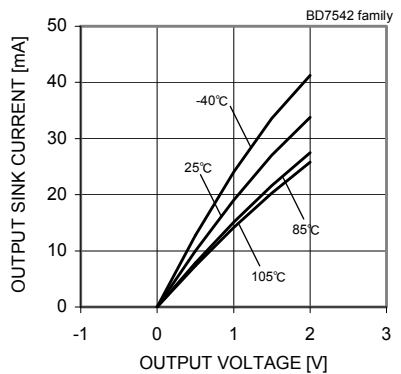

Fig.11  
Output Sink Current - Output Voltage  
( $V_{DD}=12[V]$ )

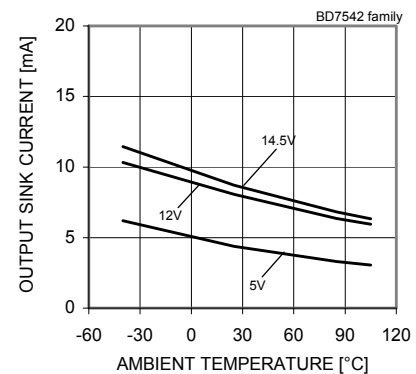

Fig.12  
Output Sink Current - Ambient Temperature  
( $V_{OUT}=V_{DD}-11.6[V]$ )

(\* )The above data is ability value of sample, it is not guaranteed. BD7561 : -40[°C]~+85[°C] BD7561S : -40[°C]~+105[°C]

○BD7542 family

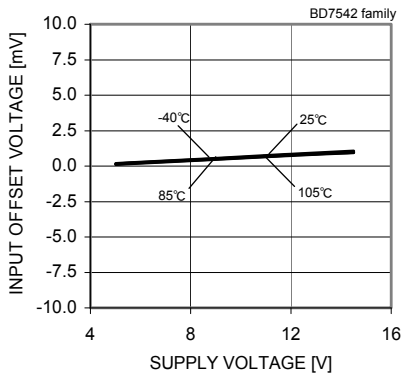

Fig. 13  
Input Offset Voltage – Supply Voltage  
( $V_{icm}=V_{DD}$ ,  $V_{OUT}=V_{DD}/2$ )

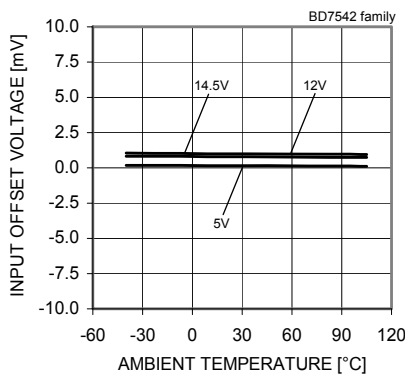

Fig. 14  
Input Offset Voltage – Ambient Temperature  
( $V_{icm}=V_{DD}$ ,  $V_{OUT}=V_{DD}/2$ )

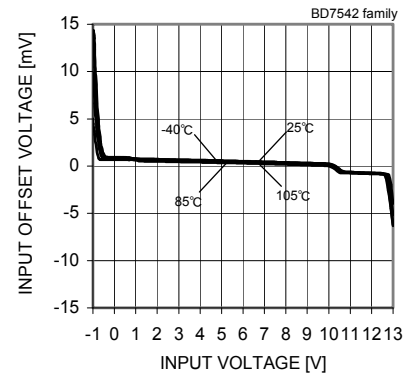

Fig. 15  
Input Offset Voltage – Input Voltage  
( $V_{DD}=12[V]$ )

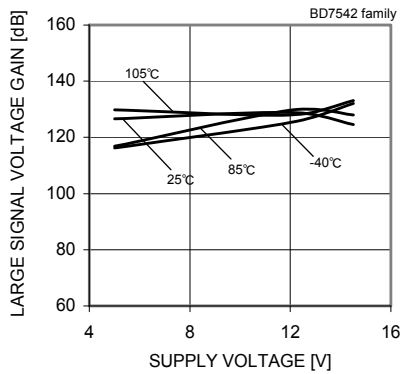

Fig. 16  
Large Signal Voltage Gain  
– Supply Voltage

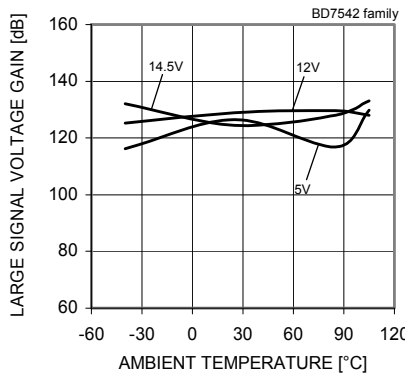

Fig. 17  
Large Signal Voltage Gain  
– Ambient Temperature

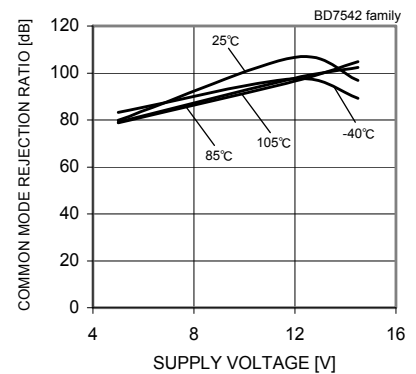

Fig. 18  
Common Mode Rejection Ratio  
– Supply Voltage  
( $V_{DD}=12[V]$ )

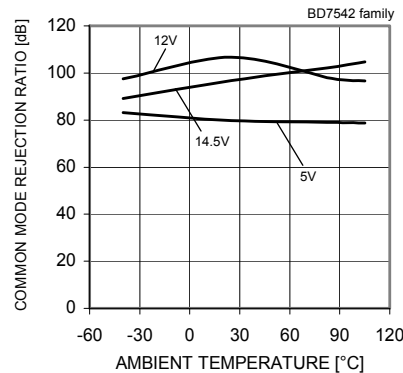

Fig. 19  
Common Mode Rejection Ratio  
– Ambient Temperature  
( $V_{DD}=12[V]$ )

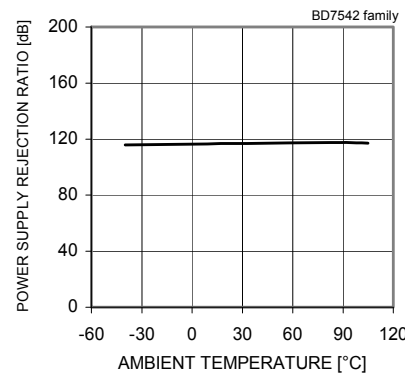

Fig. 20  
Power Supply Rejection Ratio  
– Ambient Temperature

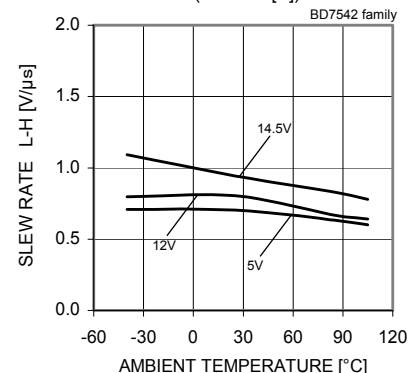

Fig. 21  
Slew Rate L-H – Ambient Temperature

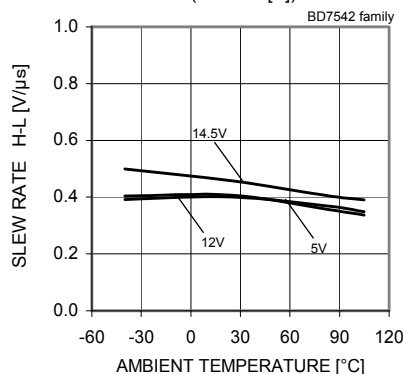

Fig. 22  
Slew Rate H-L – Ambient Temperature

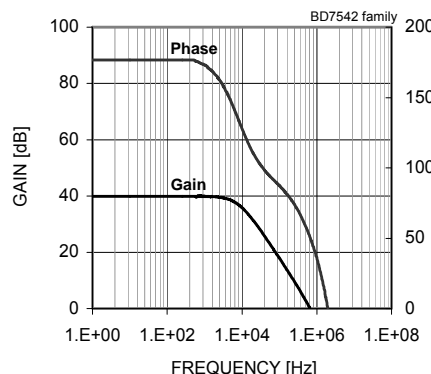

Fig. 23  
Gain - Frequency

(\* )The above data is ability value of sample, it is not guaranteed. BD7561 : -40[°C]~+85[°C] BD7561S : -40[°C]~+105[°C]

● Schematic diagram

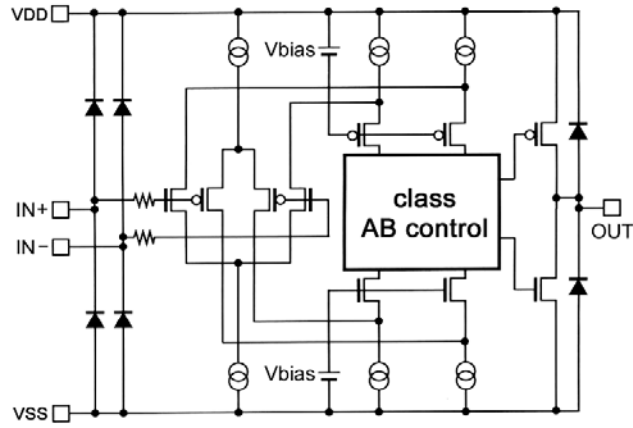

Fig1. Schematic diagram

● Test circuit1 NULL method

VDD, VSS, EK, Vicm Unit : [V]

Parameter	VF	S1	S2	S3	VDD	VSS	EK	Vicm	Calculation
Input Offset Voltage	VF1	ON	ON	OFF	12	0	-6	12	1
Large Signal Voltage Gain	VF2	ON	ON	ON	12	0	-0.5	6	2
	VF3						-11.5		
Common-mode Rejection Ratio (Input Common-mode Voltage Range)	VF4	ON	ON	OFF	12	0	-6	0	3
	VF5							12	
Power Supply Rejection Ratio	VF6	ON	ON	OFF	5	0	-2.5	0	4
	VF7				14.5				

— Calculation —

1. Input Offset Voltage (Vio)

$$V_{io} = \frac{|VF1|}{1+R_f/R_s} \text{ [V]}$$

2. Large Signal Voltage Gain (Av)

$$A_v = 20 \log \frac{2 \times (1+R_f/R_s)}{|VF2-VF3|} \text{ [dB]}$$

3. Common-mode Rejection Ratio (CMRR)

$$CMRR = 20 \log \frac{1.8 \times (1+R_f/R_s)}{|VF4-VF5|} \text{ [dB]}$$

4. Power Supply Rejection Ratio (PSRR)

$$PSRR = 20 \log \frac{3.8 \times (1+R_f/R_s)}{|VF6-VF7|} \text{ [dB]}$$

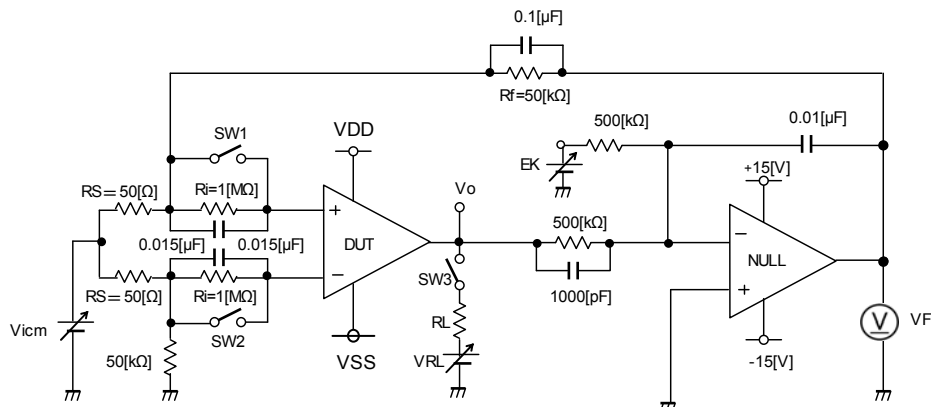

Fig.2 Test circuit 1 (one channel only)

● Test circuit2 switch condition

Unit : [V]

SW No.	SW 1	SW 2	SW 3	SW 4	SW 5	SW 6	SW 7	SW 8	SW 9	SW 10	SW 11	SW 12
Supply Current	OFF	OFF	ON	OFF	ON	OFF	OFF	OFF	OFF	OFF	OFF	OFF
Maximum Output Voltage $R_L=10$ [k $\Omega$ ]	OFF	ON	OFF	OFF	ON	OFF	OFF	ON	OFF	OFF	ON	OFF
Output Current	OFF	ON	OFF	OFF	ON	OFF	OFF	OFF	OFF	ON	OFF	OFF
Slew Rate	OFF	OFF	ON	OFF	OFF	OFF	ON	OFF	ON	OFF	OFF	ON
Maximum Frequency	ON	OFF	OFF	ON	ON	OFF	OFF	OFF	ON	OFF	OFF	ON

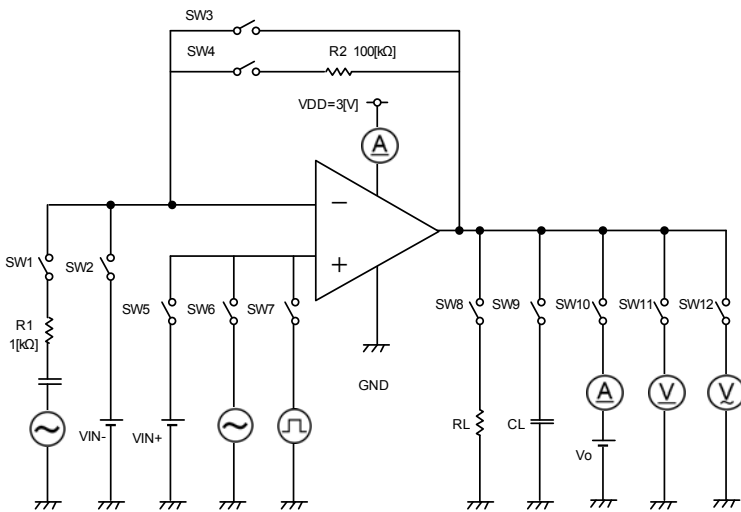

Fig3. Test circuit2

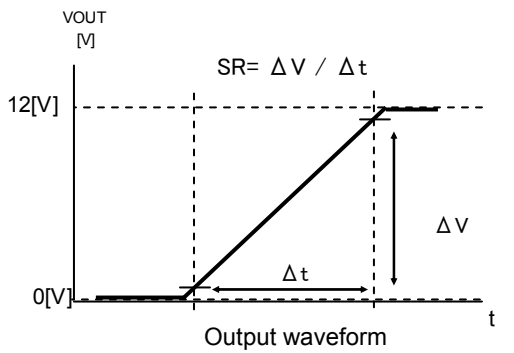
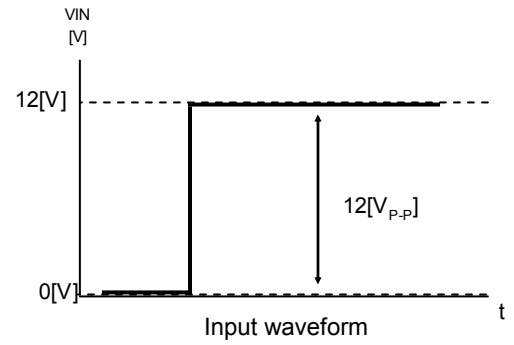

Fig4. Slew rate input output wave

● Test circuit3 Channel separation

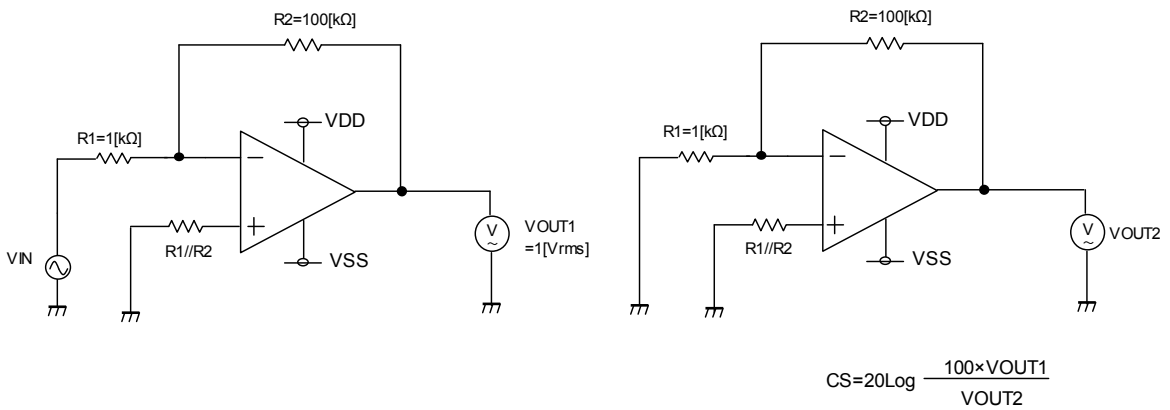

Fig5. Test circuit3

## ● Description of electrical characteristics

Described here are the terms of electric characteristics used in this technical note. Items and symbols used are also shown. Note that item name and symbol and their meaning may differ from those on another manufacture's document or general document.

### 1. Absolute maximum ratings

Absolute maximum rating item indicates the condition which must not be exceeded. Application of voltage in excess of absolute maximum rating or use out of absolute maximum rated temperature environment may cause deterioration of characteristics.

- 1.1 Power supply voltage (VDD/VSS)  
Indicates the maximum voltage that can be applied between the positive power supply terminal and negative power supply terminal without deterioration or destruction of characteristics of internal circuit.
- 1.2 Differential input voltage (Vid)  
Indicates the maximum voltage that can be applied between non-inverting terminal and inverting terminal without deterioration and destruction of characteristics of IC.
- 1.3 Input common-mode voltage range (Vicm)  
Indicates the maximum voltage that can be applied to non-inverting terminal and inverting terminal without deterioration or destruction of characteristics. Input common-mode voltage range of the maximum ratings not assure normal operation of IC. When normal Operation of IC is desired, the input common-mode voltage of characteristics item must be followed.
- 1.4 Power dissipation (Pd)  
Indicates the power that can be consumed by specified mounted board at the ambient temperature 25°C(normal temperature). As for package product, Pd is determined by the temperature that can be permitted by IC chip in the package (maximum junction temperature) and thermal resistance of the package.

### 2. Electrical characteristics item

- 2.1 Input offset voltage (Vio)  
Indicates the voltage difference between non-inverting terminal and inverting terminal. It can be translated into the input voltage difference required for setting the output voltage at 0 [V].
- 2.2 Input offset current (Iio)  
Indicates the difference of input bias current between non-inverting terminal and inverting terminal.
- 2.3 Input bias current (Ib)  
Indicates the current that flows into or out of the input terminal. It is defined by the average of input bias current at non-inverting terminal and input bias current at inverting terminal.
- 2.4 Circuit current (ICC)  
Indicates the IC current that flows under specified conditions and no-load steady status.
- 2.5 High level output voltage / Low level output voltage (VOH/VOL)  
Indicates the voltage range that can be output by the IC under specified load condition. It is typically divided into high-level output voltage and low-level output voltage. High-level output voltage indicates the upper limit of output voltage. Low-level output voltage indicates the lower limit.
- 2.6 Large signal voltage gain (AV)  
Indicates the amplifying rate (gain) of output voltage against the voltage difference between non-inverting terminal and inverting terminal. It is normally the amplifying rate (gain) with reference to DC voltage.  
$$A_v = (\text{Output voltage fluctuation}) / (\text{Input offset fluctuation})$$
- 2.7 Input common-mode voltage range (Vicm)  
Indicates the input voltage range where IC operates normally.
- 2.8 Common-mode rejection ratio (CMRR)  
Indicates the ratio of fluctuation of input offset voltage when in-phase input voltage is changed. It is normally the fluctuation of DC.  
$$\text{CMRR} = (\text{Change of Input common-mode voltage}) / (\text{Input offset fluctuation})$$
- 2.9 Power supply rejection ratio (PSRR)  
Indicates the ratio of fluctuation of input offset voltage when supply voltage is changed. It is normally the fluctuation of DC.  
$$\text{PSRR} = (\text{Change of power supply voltage}) / (\text{Input offset fluctuation})$$
- 2.10 Channel separation (CS)  
Indicates the fluctuation of input offset voltage or that of output voltage with reference to the change of output voltage of driven channel.
- 2.11 Slew rate (SR)  
Indicates the time fluctuation ratio of voltage output when step input signal is applied.
- 2.12 Unity gain frequency (ft)  
Indicates a frequency where the voltage gain of Op-Amp is 1.
- 2.13 Total harmonic distortion + Noise (THD + N)  
Indicates the fluctuation of input offset voltage or that of output voltage with reference to the change of output voltage of driven channel.
- 2.14 Input referred noise voltage (Vn)  
Indicates a noise voltage generated inside the operational amplifier equivalent by ideal voltage source connected in series with input terminal.

● Derating curve

Power dissipation (total loss) indicates the power that can be consumed by IC at Ta=25°C(normal temperature). IC is heated when it consumed power, and the temperature of IC chip becomes higher than ambient temperature. The temperature that can be accepted by IC chip depends on circuit configuration, manufacturing process, and consumable power is limited. Power dissipation is determined by the temperature allowed in IC chip (maximum junction temperature) and thermal resistance of package (heat dissipation capability). The maximum junction temperature is typically equal to the maximum value in the storage temperature range. Heat generated by consumed power of IC radiates from the mold resin or lead frame of the package. The parameter which indicates this heat dissipation capability (hardness of heat release) is called thermal resistance, represented by the symbol  $\theta_{j-a}$ [°C/W]. The temperature of IC inside the package can be estimated by this thermal resistance. Fig.6 (a) shows the model of thermal resistance of the package. Thermal resistance  $\theta_{ja}$ , ambient temperature Ta, junction temperature Tj, and power dissipation Pd can be calculated by the equation below :

$$\theta_{ja} = (T_j - T_a) / P_d \quad [^{\circ}\text{C}/\text{W}] \quad \dots \dots (1)$$

Derating curve in Fig.6 (b) indicates power that can be consumed by IC with reference to ambient temperature. Power that can be consumed by IC begins to attenuate at certain ambient temperature. This gradient is determined by thermal resistance  $\theta_{ja}$ . Thermal resistance  $\theta_{ja}$  depends on chip size, power consumption, package, ambient temperature, package condition, wind velocity, etc even when the same of package is used. Thermal reduction curve indicates a reference value measured at a specified condition. Fig7(c)-(f) show a derating curve for an example of BU7561family, BU7562family, 7541family, 7542family.

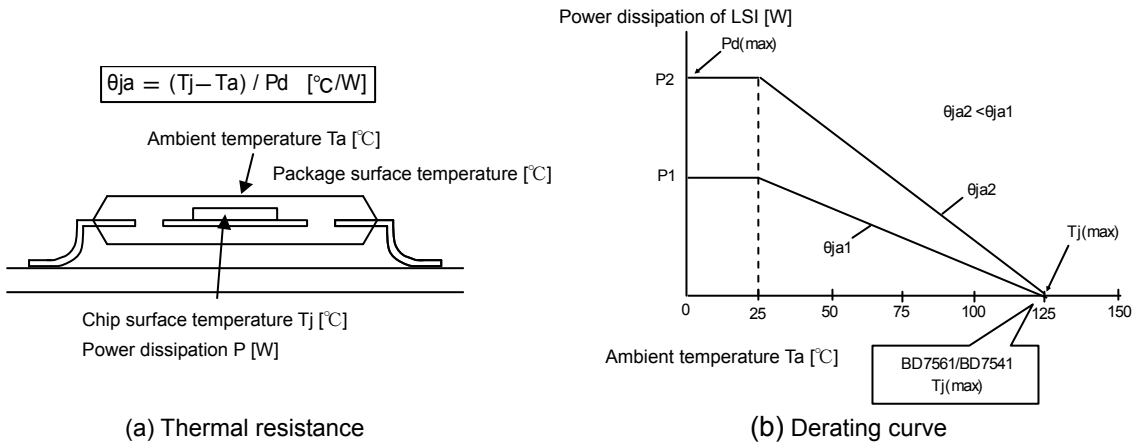
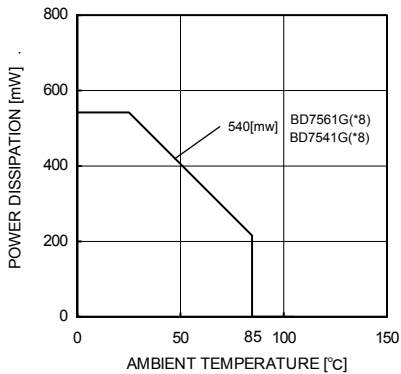
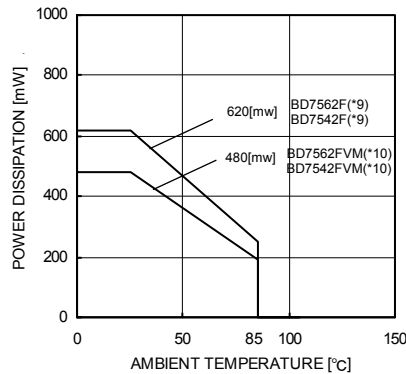

Fig.6 Thermal resistance and derating



(c) BD7561G BD7541G



(d) BD7562F/FVM BD7542F/FVM

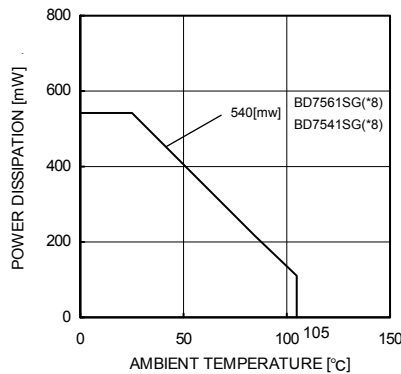

(e) BD7561SG BD7541SG

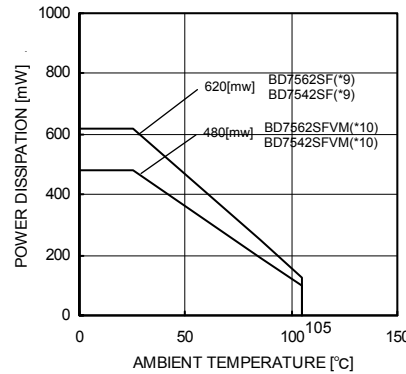

(f) BD7562S F/FVM BD7542S F/FVM

(*8)	(*9)	(*10)	Unit
5.4	6.2	4.8	[mW/°C]

When using the unit above Ta=25[°C], subtract the value above per degree[°C]. Permissible dissipation is the value when FR4 glass epoxy board 70[mm]×70[mm]×1.6[mm] (cooper foil area below 3[℅]) is mounted.

Fig.7 Derating curve

## ●Cautions on use

- 1) Absolute maximum ratings  
Absolute maximum ratings are the values which indicate the limits, within which the given voltage range can be safely charged to the terminal. However, it does not guarantee the circuit operation.
- 2) Applied voltage to the input terminal  
For normal circuit operation of voltage comparator, please input voltage for its input terminal within input common mode voltage  $V_{DD}+0.3[V]$ . Then, regardless of power supply voltage,  $V_{SS}-0.3[V]$  can be applied to input terminals without deterioration or destruction of its characteristics.
- 3) Operating power supply (split power supply/single power supply)  
The voltage comparator operates if a given level of voltage is applied between VDD and VSS. Therefore, the operational amplifier can be operated under single power supply or split power supply.
- 4) Power dissipation (Pd)  
If the IC is used under excessive power dissipation. An increase in the chip temperature will cause deterioration of the radical characteristics of IC.  
For example, reduction of current capability. Take consideration of the effective power dissipation and thermal design with a sufficient margin. Pd is reference to the provided power dissipation curve.
- 5) Short circuits between pins and incorrect mounting  
Short circuits between pins and incorrect mounting when mounting the IC on a printed circuits board, take notice of the direction and positioning of the IC.  
If IC is mounted erroneously, It may be damaged. Also, when a foreign object is inserted between output, between output and VDD terminal or VSS terminal which causes short circuit, the IC may be damaged.
- 6) Using under strong electromagnetic field  
Be careful when using the IC under strong electromagnetic field because it may malfunction.
- 7) Usage of IC  
When stress is applied to the IC through warp of the printed circuit board, The characteristics may fluctuate due to the piezo effect.  
Be careful of the warp of the printed circuit board.
- 8) Testing IC on the set board  
When testing IC on the set board, in cases where the capacitor is connected to the low impedance, make sure to discharge per fabrication because there is a possibility that IC may be damaged by stress.  
When removing IC from the set board, it is essential to cut supply voltage.  
As a countermeasure against the static electricity, observe proper grounding during fabrication process and take due care when carrying and storage it.
- 9) The IC destruction caused by capacitive load  
The transistors in circuits may be damaged when VDD terminal and VSS terminal is shorted with the charged output terminal capacitor. When IC is used as a operational amplifier or as an application circuit, where oscillation is not activated by an output capacitor, the output capacitor must be kept below  $0.1[\mu F]$  in order to prevent the damage mentioned above.
- 10) Decoupling capacitor  
Insert the decoupling capacitance between VDD and VSS, for stable operation of operational amplifier.
- 11) Latch up  
Be careful of input voltage that exceed the VDD and VSS. When CMOS device have sometimes occur latch up operation. And protect the IC from abnormally noise.

● Dimensions

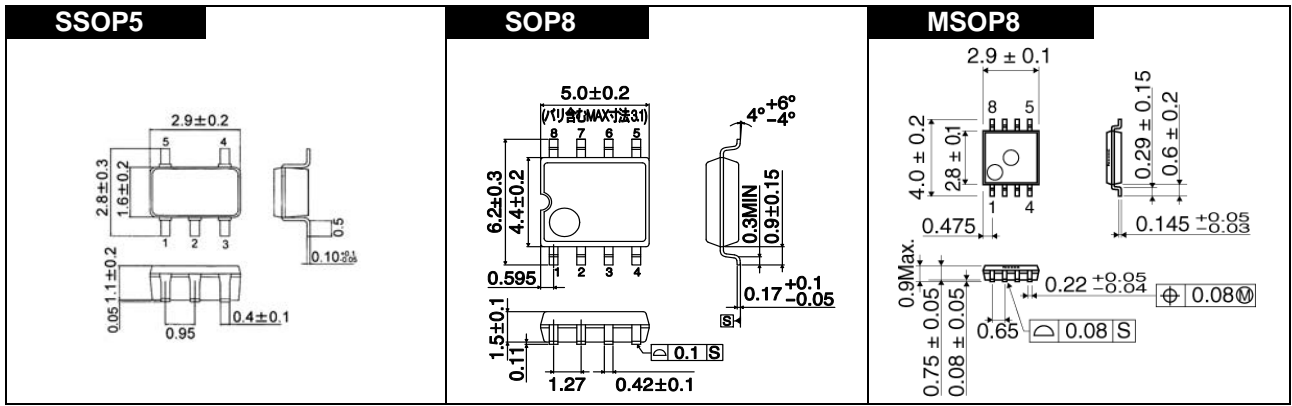

(Unit:mm)

● Model number construction

- Specify the product by the model number when placing an order.
- Make sure of the combinations of items.
- Start with the leftmost space without leaving any empty space between characters.

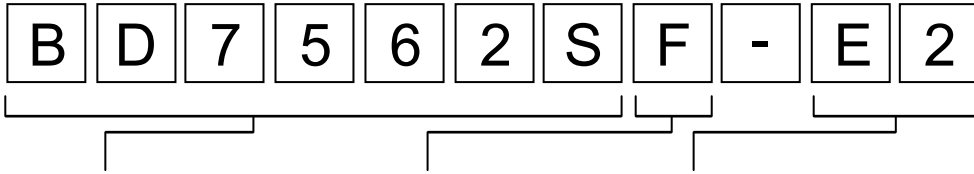

**Product name**

- BD7561 BD7561S
- BD7541 BD7541S
- BD7562 BD7562S
- BD7542 BD7542S

**Package type**

- G : SSOP5
- F : SOP8
- FVM : MSOP8

**E2 Embossed tape on reel with pin 1 near far when pulled out**  
**TR Embossed tape on reel with pin 1 near far when pulled out**

Packing specification reference

Package	Packing specification name	Quantity	Embossed carrier tape
SSOP5	TR	3000	
SOP8	E2	2500	
MSOP8	TR	3000	

※When you order , please order in times the amount of package quantity.

- The contents described herein are correct as of December, 2008
- The contents described herein are subject to change without notice. For updates of the latest information, please contact and confirm with ROHM CO.,LTD.
- Any part of this application note must not be duplicated or copied without our permission.
- Application circuit diagrams and circuit constants contained herein are shown as examples of standard use and operation. Please pay careful attention to the peripheral conditions when designing circuits and deciding upon circuit constants in the set.
- Any data, including, but not limited to application circuit diagrams and information, described herein are intended only as illustrations of such devices and not as the specifications for such devices. ROHM CO.,LTD. disclaims any warranty that any use of such devices shall be free from infringement of any third party's intellectual property rights or other proprietary rights, and further, assumes no liability of whatsoever nature in the event of any such infringement, or arising from or connected with or related to the use of such devices.
- Upon the sale of any such devices, other than for buyer's right to use such devices itself, resell or otherwise dispose of the same, implied right or license to practice or commercially exploit any intellectual property rights or other proprietary rights owned or controlled by ROHM CO., LTD. is granted to any such buyer.
- The products described herein utilize silicon as the main material.
- The products described herein are not designed to be X ray proof.

The products listed in this catalog are designed to be used with ordinary electronic equipment or devices (such as audio visual equipment, office-automation equipment, communications devices, electrical appliances and electronic toys). Should you intend to use these products with equipment or devices which require an extremely high level of reliability and the malfunction of which would directly endanger human life (such as medical instruments, transportation equipment, aerospace machinery, nuclear-reactor controllers, fuel controllers and other safety devices), please be sure to consult with our sales representative in advance.

R0118A

Excellence in Electronics



**ROHM CO., LTD.**

21 Saini Mizosaki-cho, Ukyo-ku, Kyoto  
 615-8585, Japan  
 TEL: +81-75-311-2121 FAX: +81-75-315-0172  
 URL: http://www.rohm.com

Published by  
 KTC LSI Development Headquarters  
 LSI Business Promotion Group

Contact us for further information about the products.

San Diego +1-858-625-3630  
 Atlanta +1-770-754-5972  
 Boston +1-978-371-0362  
 Chicago +1-847-368-1006  
 Dallas +1-972-473-3748  
 Denver +1-303-708-0908  
 Detroit +1-248-348-9920  
 Nashville +1-615-620-6700  
 Mexico +52-33-3123-2001  
 Düsseldorf +49-2154-9210  
 Munich +49-8999-21618  
 Stuttgart +49-711-7272-370  
 France +33-1-5697-3060

United Kingdom +44-1-908-272400  
 Denmark +45-3694-4739  
 Espoo +358-9725-54491  
 Safo +358-2-732234  
 Oulu +358-8-5372930  
 Barcelona +34-9375-24320  
 Hungary +36-1-4719338  
 Poland +48-22-5757213  
 Russia +7-495-739-4174  
 Seoul +82-2-8182-2000  
 Masan +82-55-240-6234  
 Dalian +86-411-8230-8549  
 Beijing +86-10-8525-2483

Tianjin +86-22-23029181  
 Shanghai +86-21-8279-2727  
 Hangzhou +86-571-87658072  
 Nanjing +86-25-8689-0015  
 Ningbo +86-574-87654201  
 Qingdao +86-532-8577-9312  
 Suzhou +86-512-6807-1300  
 Wuxi +86-510-82702693  
 Guangzhou +86-20-3878-8100  
 Huizhou +86-752-205-1054  
 Fuzhou +86-591-8801-8698  
 Dongguan +86-769-3393-3320  
 Shenzhen +86-755-8307-3008

Xiamen +86-592-238-5705  
 Zhuhai +86-756-3232-480  
 Hong Kong +852-2740-6262  
 Taipei +886-2-2500-6996  
 Kaohsiung +886-7-237-0881  
 Singapore +65-6332-2322  
 Philippines +63-2-807-6872  
 Thailand +66-2-254-4890  
 Kuala Lumpur +60-3-7958-8355  
 Penang +60-4-2286453  
 Kyoto +81-75-365-1218  
 Yokohama +81-45-476-2290



### Notes

No copying or reproduction of this document, in part or in whole, is permitted without the consent of ROHM CO.,LTD.

The content specified herein is subject to change for improvement without notice.

The content specified herein is for the purpose of introducing ROHM's products (hereinafter "Products"). If you wish to use any such Product, please be sure to refer to the specifications, which can be obtained from ROHM upon request.

Examples of application circuits, circuit constants and any other information contained herein illustrate the standard usage and operations of the Products. The peripheral conditions must be taken into account when designing circuits for mass production.

Great care was taken in ensuring the accuracy of the information specified in this document. However, should you incur any damage arising from any inaccuracy or misprint of such information, ROHM shall bear no responsibility for such damage.

The technical information specified herein is intended only to show the typical functions of and examples of application circuits for the Products. ROHM does not grant you, explicitly or implicitly, any license to use or exercise intellectual property or other rights held by ROHM and other parties. ROHM shall bear no responsibility whatsoever for any dispute arising from the use of such technical information.

The Products specified in this document are intended to be used with general-use electronic equipment or devices (such as audio visual equipment, office-automation equipment, communication devices, electronic appliances and amusement devices).

The Products are not designed to be radiation tolerant.

While ROHM always makes efforts to enhance the quality and reliability of its Products, a Product may fail or malfunction for a variety of reasons.

Please be sure to implement in your equipment using the Products safety measures to guard against the possibility of physical injury, fire or any other damage caused in the event of the failure of any Product, such as derating, redundancy, fire control and fail-safe designs. ROHM shall bear no responsibility whatsoever for your use of any Product outside of the prescribed scope or not in accordance with the instruction manual.

The Products are not designed or manufactured to be used with any equipment, device or system which requires an extremely high level of reliability the failure or malfunction of which may result in a direct threat to human life or create a risk of human injury (such as a medical instrument, transportation equipment, aerospace machinery, nuclear-reactor controller, fuel-controller or other safety device). ROHM shall bear no responsibility in any way for use of any of the Products for the above special purposes. If a Product is intended to be used for any such special purpose, please contact a ROHM sales representative before purchasing.

If you intend to export or ship overseas any Product or technology specified herein that may be controlled under the Foreign Exchange and the Foreign Trade Law, you will be required to obtain a license or permit under the Law.

Thank you for your accessing to ROHM product informations.

More detail product informations and catalogs are available, please contact your nearest sales office.

**ROHM** Customer Support System

THE AMERICAS / EUROPE / ASIA / JAPAN

[www.rohm.com](http://www.rohm.com)

Contact us : [webmaster@rohm.co.jp](mailto:webmaster@rohm.co.jp)