

REVISION BV

DO NOT SCALE FROM THIS PRINT

FIGURE 1
VERTICAL MOUNT

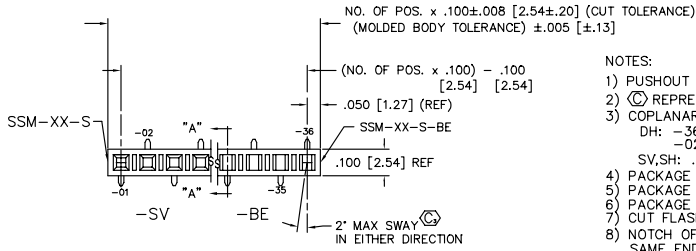

- NOTES:
- 1) PUSHOUT FORCE TO BE: 1 lb. MIN.
 - 2) Ⓢ REPRESENTS CRITICAL DIM.
 - 3) COPLANARITY TO BE :
DH: -36 - 28 POS: .008" [.20]
-02 - 27 POS: .006" [.15]
SV,SH: .006" [.15]
 - 4) PACKAGE POS -02 THRU -36 IN TUBES. (SEE SHEET 3, TABLE 2)
 - 5) PACKAGE ONLY POS -04 THRU -36 IN TUBES. (SEE SHEET 3, TABLE 2)
 - 6) PACKAGE ONLY POS -03 THRU -36 IN TUBES. (SEE SHEET 3, TABLE 2)
 - 7) CUT FLASH TO BE .015 [.38] MAX
 - 8) NOTCH OF PPP-12 TO BE ORIENTED TOWARD SAME END AS POSITION 1.
 - 9) ROWS TO BE WITHIN .004[.10] OF ONE ANOTHER.
 - 10) -36 MAX POSITION AVAILABLE, -50 FOR STOCK ONLY.

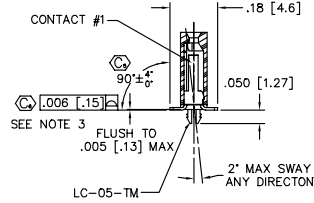

TABLE 1

BODY/LEAD STYLE	CONTACT #1	CONTACT #2
-SV	C-95-02-X	-----
-SH	C-58-06-X	-----
-DH	C-58-08-X	C-58-07-X

UNLESS OTHERWISE NOTED

TOLERANCES ARE:

ONE PLACE DECIMALS ±.1 [3] THREE PLACE DECIMALS ± .005 [.13] ANGLES ± 2°

TWO PLACE DECIMALS ±.01 [.3] FOUR PLACE DECIMALS ± .0020 [.051]

TITLE: .100 [2.54] C.L. SURFACE MOUNT SOCKET STRIP

DWG NO: SSM-1XX-XXX-XX-XX-XX-X-XX

SHEET 1 OF 3

- SSM-1XX-XXX-XX-XX-XX-X-XX
- NO. OF POSITIONS
-02 THRU -36 (SEE NOTE 10)
- PLATING SPEC.
-S: SELECTIVE
-L: LIGHT SELECTIVE
-T: TIN
-F: SELECTIVE FLASH GOLD
-P: GOLD FLASHED PALLADIUM NICKEL
-STL: SELECTIVE TIN LEAD (-SV ONLY)
-H: HEAVY GOLD [IN/A ON -DH]
-SM: SELECTIVE MATTE TIN
-LM: LIGHT SELECTIVE MATTE TIN
-TM: MATTE TIN
-FM: FLASH SELECTIVE MATTE TIN
- BODY/LEAD STYLE
-SV: SINGLE VERTICAL (SEE FIGURE 1) USE SSM-XX-S
-SH: SINGLE HORIZONTAL (SEE FIGURE 2) USE SSM-XX-SH
-DH: DOUBLE HORIZONTAL (SEE FIGURE 2) USE BCH-XX-D
- OPTION
-BE: BOTTOM ENTRY (ONLY AVAILABLE ON -SV) (FOR SV, USE SSM-XX-S-BE) (SEE FIG. 1)
- OPTION
-P: PICK -N- PLACE PAD (ONLY AVAILABLE ON -SV) (IF POLARIZATION OCCURS AT CENTER POSITION(S) OF BODY, MOVE PICK-IN- PLACE PAD LEFT OR RIGHT TO NEXT AVAILABLE POSITION.
-TR: TAPE AND REEL (29 POSITIONS MAX)
-K: POLYAMIDE FILM PAD (AVAILABLE ON POS. 5 THRU 36 ONLY) (.005 [.13] THICKNESS WITH SILICONE ADHESIVE) (SEE FIG 5, SHT 2) (USE K-500-300) (NOT AVAILABLE ON -SH AND -DH ROW OPTIONS)
- POLARIZING OPTION
-XX = POSITION TO BE POLARIZED (USE PK-06-N) (SEE FIG. 9 SHEET 2 FOR POLARIZING POSITIONS) (NOT AVAILABLE FOR -BE OPTION)
- MOUNTING OPTION
-LC: LOCKING CLIP (USE 2 LC-05-TM) (FOR -SH AND -DH USE MOLDED TO POSITION BODIES)

-SV

SECTION 'A-A'

FIGURE 2
HORIZONTAL MOUNT

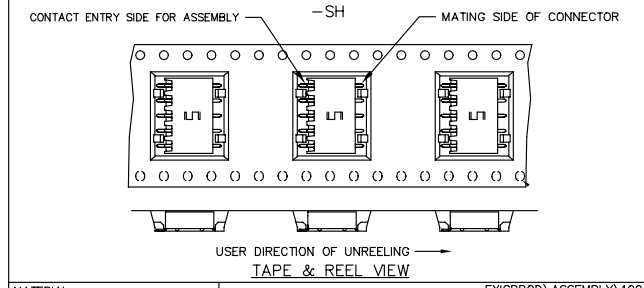
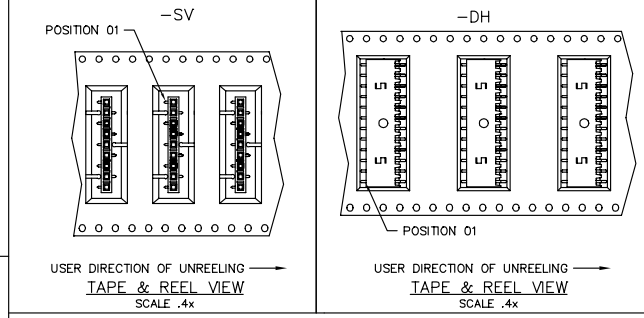
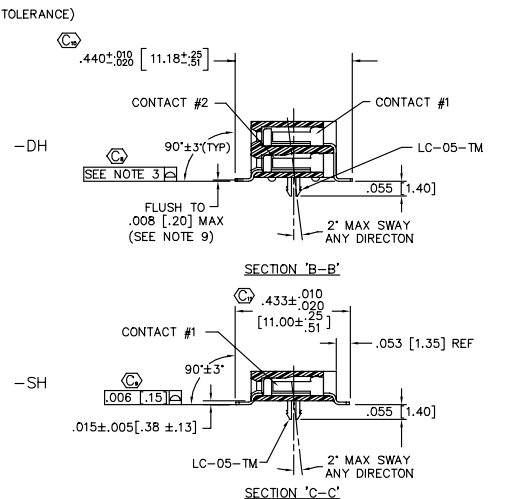
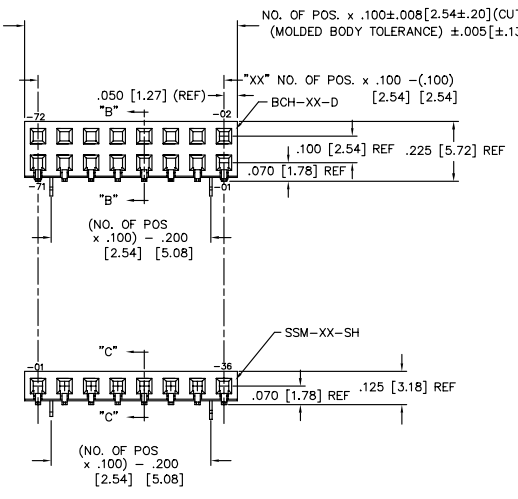
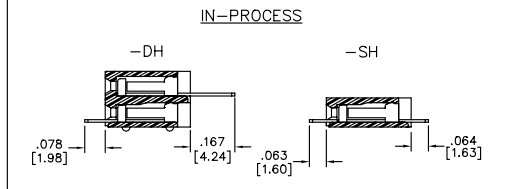
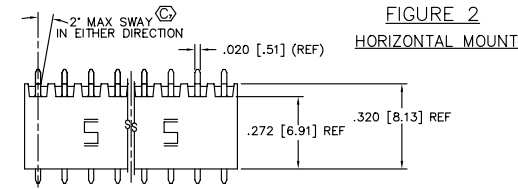

MATERIAL:

BODIES:

PRIMARY: VECTRA E130I

ALTERNATIVE: ZENITE 6130

CONTACTS:

PHOS BRONZE

CA510 SPRING

EXISPROD\ASSEMBLY\100 SSM-ASM

samtec

520 PARK EAST BLVD., NEW ALBANY, INDIANA 47150

PHONE (812) 944-6733 P.O. BOX 1147

CODE 55322

MADE BY: KOLB 9-12-91

SSM-1XX-XXX-XX-XX-XX-X-XX

SHEET 1 OF 3

PROPRIETARY NOTE

THIS DOCUMENT CONTAINS INFORMATION CONFIDENTIAL AND PROPRIETARY TO SAMTEC INC. AND SHALL NOT BE REPRODUCED OR TRANSMITTED IN ANY FORM OR BY ANY MEANS, ELECTRONIC OR MECHANICAL, INCLUDING PHOTOCOPYING, RECORDING, OR BY ANY INFORMATION STORAGE AND RETRIEVAL SYSTEM, WITHOUT THE WRITTEN CONSENT OF SAMTEC INC.