



## INSTRUMET 19" CASES

[Home Page](#)
[E-Mail Us](#)
[Catalogue PDF](#)
[Get a Catalogue](#)
[Get a Drawing](#)
[Get a Price](#)
[Get a Quote](#)
[Customising](#)
[IP Ratings](#)
[Colour Chart](#)
[Ordering Info](#)
 **01489 583858**
 **01489 583836**

### FEATURES:

- Modern aluminium 19" instrument cases
- Light weight yet robust construction
- Conforms to DIN 41494 & IEC 297-1
- Designed to accept standard 3U x 19" subracks, chassis and front panels
- Attractive design with die-cast front and rear bezels and fabricated case body
- Two versions, in three sizes
- Standard models with ABS side handles
- Portable models with tilt/swivel aluminium carry handle bar
- Supplied fully assembled and ready to use
- Internal subrack/chassis support rails
- Removable rear panel included
- Ventilation holes in base and rear panels
- Three M4 earth studs provided inside
- Moulded ABS non-slip tilt feet included
- Anodised 10.5"/19" front panels available as accessories

### MATERIAL:

- Aluminium

### PROTECTION CLASS:

- < IP 40 (Not rated)

### STANDARD COLOUR:

- Front bezel - window grey, RAL 7040
- Case body - light grey, RAL 7035 (powder polyester paint)

### SUPPLY:

1. Front/rear bezel (x2)
2. Top cover
3. Base panel
4. Rear panel
5. Chassis support
6. ABS Side handle
7. Aluminium carry handle
8. ABS tilt feet
9. M4 x 10 mm (x8)  
M4 x 12 mm (x4)
10. M3 x 8 mm (x12)

### ACCESSORIES:

- 10.5"/19" Front Panel
- 19" Subrack/ Front Panel Mounting Kit

### APPLICATIONS:

- 19" subrack or chassis based electronics such as test and measurement equipment, networking and communications devices, industrial computers, sound and studio systems, laboratory instruments and industrial control systems.

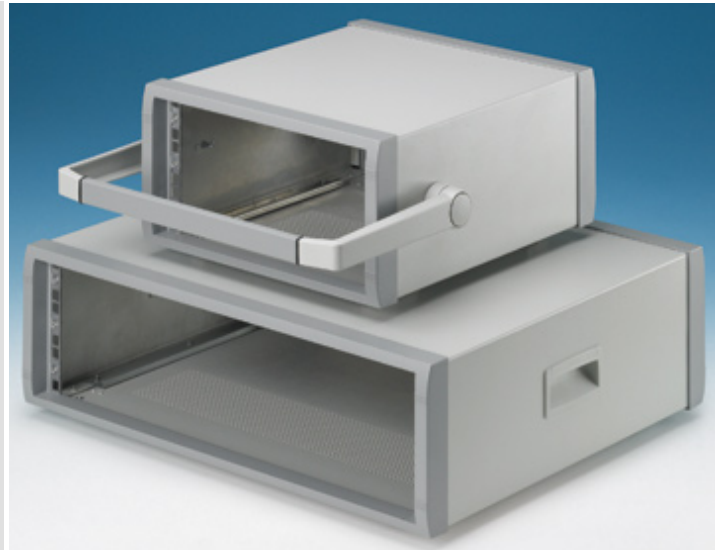
 [Printable Page](#)

Modern 19" Instrument Cases



Subrack Mounting



Carry Handle Bar





ABS Tilt Feet

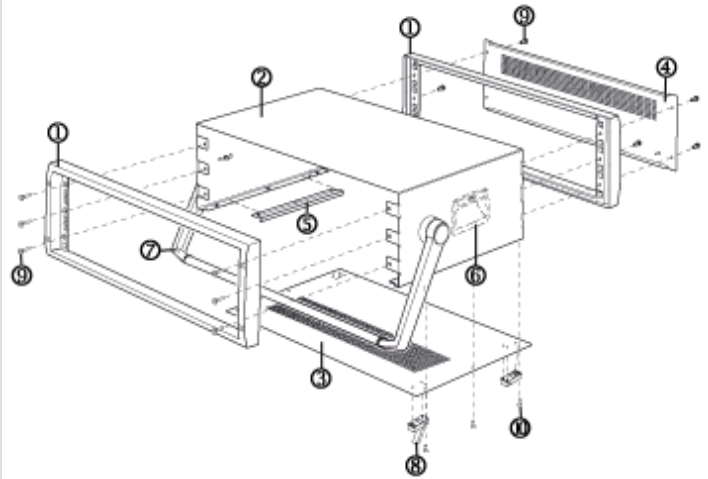

Accessory Front Panels



### INSTRUMET 10.5" CASES

							
Part No. Standard Model	Part No. Portable Model	Type	H	W	D	Drawings	
M6010305		3U x 10.5"	157	303	350	<a href="#">PDF</a>	<a href="#">DWG</a>
	M6010315	3U x 10.5"	157	303	350	<a href="#">PDF</a>	<a href="#">DWG</a>

### INSTRUMET 19" CASES

							
Part No. Standard Model	Part No. Portable Model	Type	H	W	D	Drawings	
M6019305		3U x 19"	157	516	350	<a href="#">PDF</a>	<a href="#">DWG</a>
	M6019315	3U x 19"	157	516	350	<a href="#">PDF</a>	<a href="#">DWG</a>
M6019325		3U x 19"	157	516	450	<a href="#">PDF</a>	<a href="#">DWG</a>
	M6019335	3U x 19"	157	516	450	<a href="#">PDF</a>	<a href="#">DWG</a>

### ACCESSORIES



For case..	Part No. Aluminium Front Panel		Part No. Subrack/Front Panel Mtg Kit*		Drawings	
3U x 10.5"	M6010001	£			PDF	DWG
3U x 19"	M6019001	£			PDF	DWG
All			M6000035	£		

**Notes:**

\* Front Panel Kit - Anodised front panel

\* 19" Subrack/Front Panel Mounting Kit - 4 M6 caged nuts, 4 M6 Screws &amp; 4 ABS plastic washers (RAL 7035)

 [Printable Page](#)
[Customising](#)

Tel: (01489) 583858 Last Updated: 27-Feb-2008 ©OKW Enclosures Ltd. UK. All rights reserved.

FIRST ANGLE PROJECTION

Modifications

Iss  
1

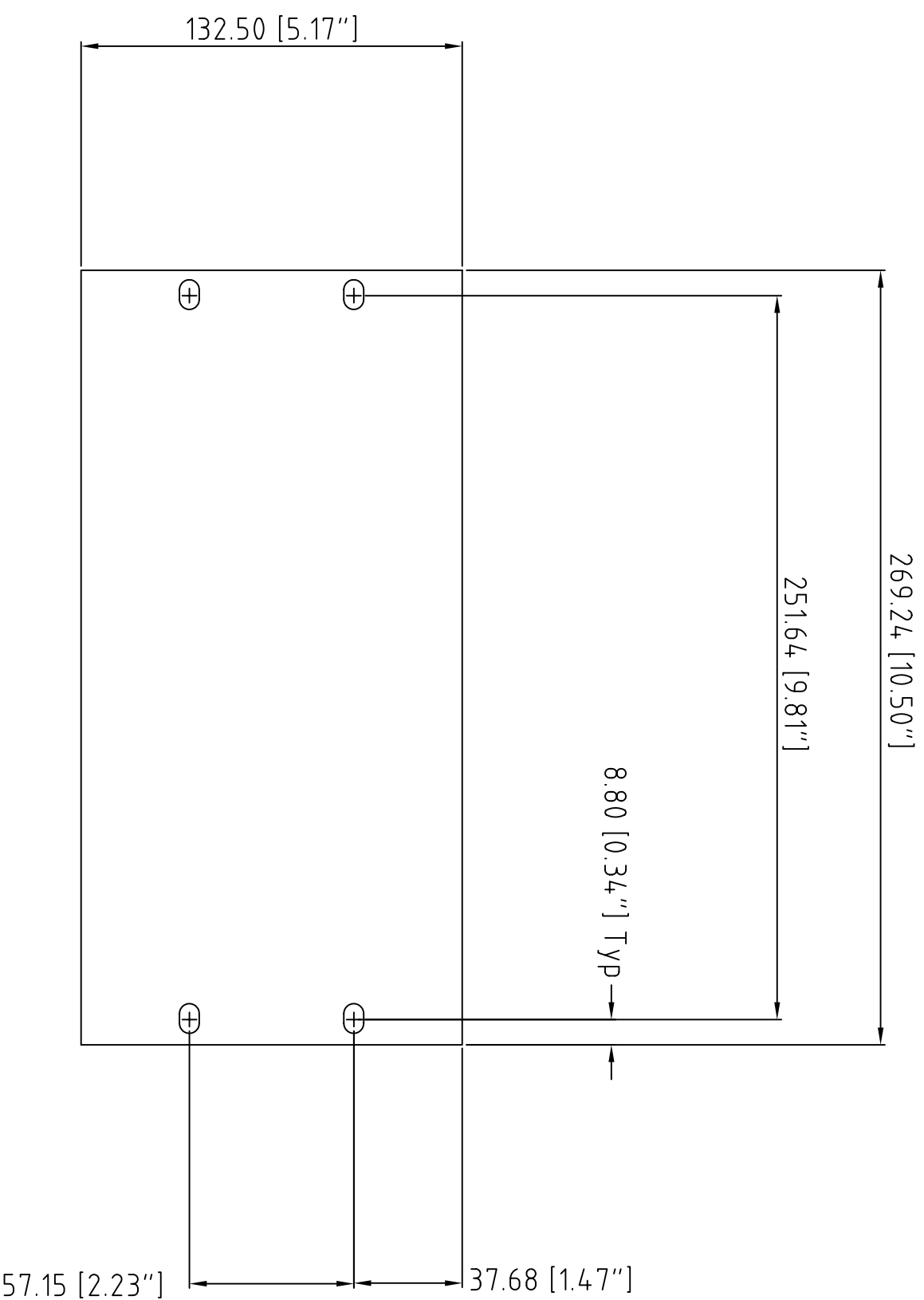

HOLE DETAILS

4 off mounting holes 10.3mm x 6.9mm obround

Tolerances unless otherwise stated:		Required Finish:		Scale:		ALL DIMENSIONS IN MILLIMETRES		DO NOT SCALE	
General tolerances ±0.20		Fitch & Clear		1:1					
Resultant tolerances between hole centers ±0.15		Anodise		Drawn By: Ian Cox		Checked By:		Material Spec: 3.0 aluminium	
Tolerances on hole diameters ±0.05						Drawing Number			
Angles ± 0.5°						METCASE ENCLOSURES		Part Name	
Surface finish 32/						15 Brunel Way		INSTRUMET Front Panel	
						Segensworth East, Fareham,		Part Number	
						Hampshire, PO15 5TX, UK.		M6010001	
						www.metcase.com		Sheet 1 of 1	
						©OKW ENCLOSURES LTD (DATE AS SHOWN). THIS DRAWING CONTAINS PROPRIETARY INFORMATION OF OKW ENCLOSURES LTD AND IS TENDERED SUBJECT TO THE FOLLOWING CONDITIONS: THE INFORMATION BE RETAINED IN CONFIDENCE, NOT BE REPRODUCED OR COPIED, AND NOT BE USED OR INCORPORATED IN ANY PRODUCT, UNLESS PERMISSION IS OBTAINED IN WRITING FROM OKW ENCLOSURES LTD.		A2	