



Major AC (AC Fan)

COMAIR ROTRON PART NUMBER: **028309**
 COMAIR ROTRON MODEL NUMBER: **MR77B3**
RoHS Certificate of Compliant



MOTOR	
Rated Voltage:	220/230
Operating Voltage Range:	
Running Current: 50Hz 60Hz (amps)	0.13 0.14
Locked Rotor Current: (amps)	0.25
Rated Power: 50Hz 60Hz (watts)	26 30
Nominal Speed: 50Hz 60Hz (rpm)	2880 3400

MECHANICAL	
Dimensions:	172mm x 150mm x 51mm (6.75in x 5.92in x 2.00in)
Bearing Type:	Ball
Motor Base:	Metal
Propeller:	Injection molded polycarbonate

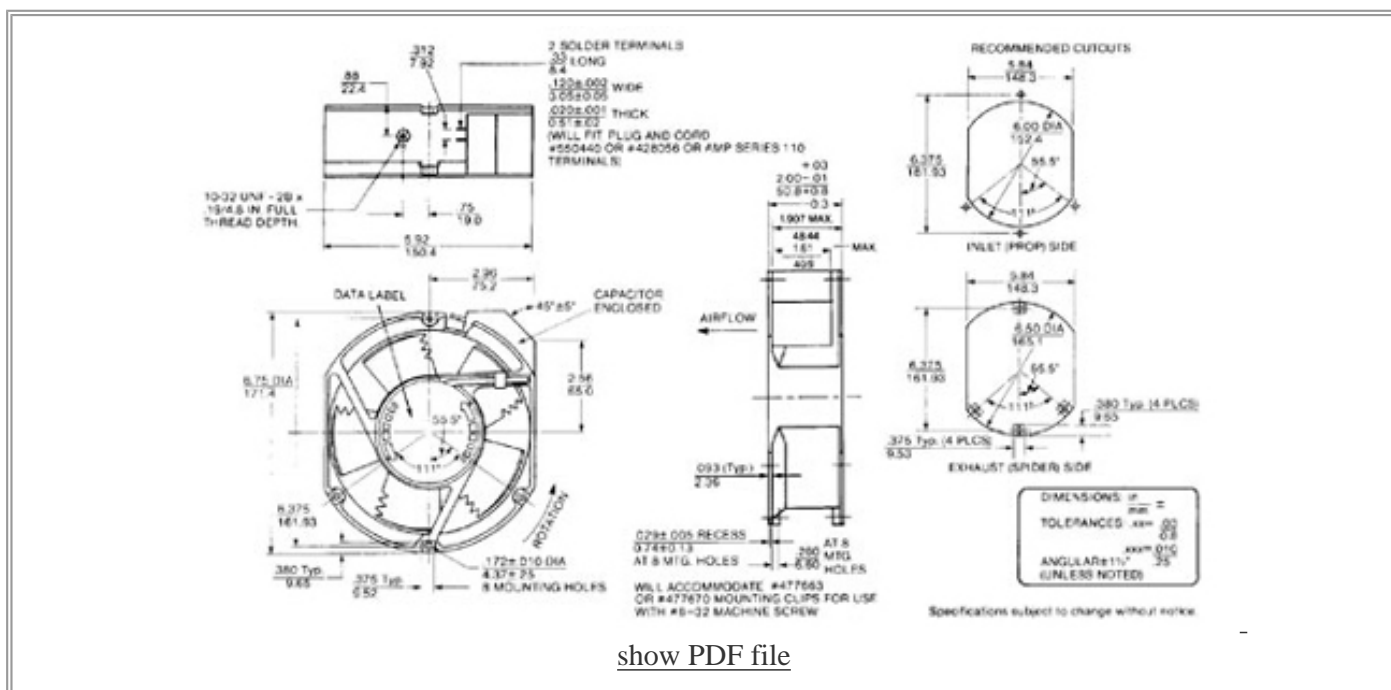





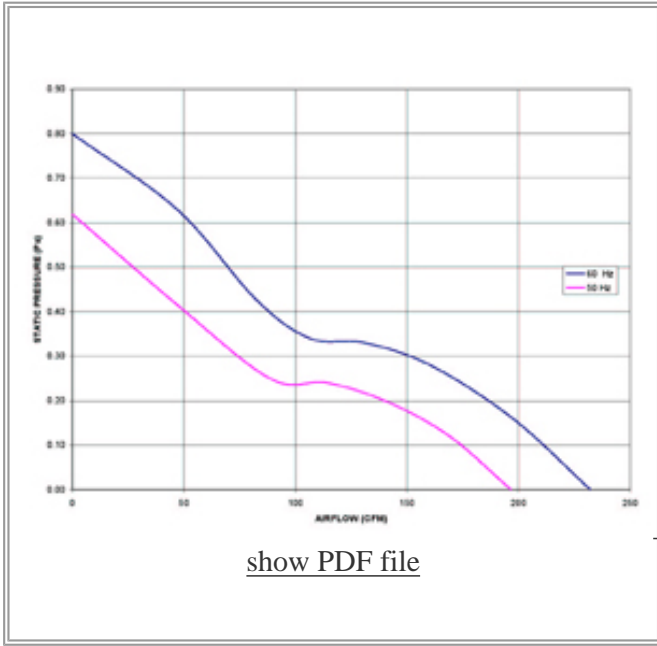

[show PDF file](#)

NOTES



PERFORMANCE CHARACTERISTICS	
Air Flow: (CFM)	200/235
Static Pressure:	.619/.800

TERMINATION	
Leadwires:	Terminals

SAFETY					
					

All product names are used under license and are trademarks or registered trademarks of Comair Rotron, Inc.

[New Search](#)