

**Precision Low Power FGA™ Voltage References**

The ISL60002 FGA™ voltage references are very high precision analog voltage references fabricated in Intersil's proprietary Floating Gate Analog technology and feature low supply voltage operation at ultra-low 400nA operating current.

Additional features include guaranteed initial accuracy as low as ±1.0mV, @ 20ppm/°C temperature coefficient and long-term stability of <<10ppm/√1kHrs. The initial accuracy and thermal stability performance of the ISL60002 family plus the low supply voltage and 400nA power consumption eliminates the need to compromise thermal stability for reduced power consumption making it an ideal companion to high resolution, low power data conversion systems.

**Features**

- Reference Voltages . . . 1.024V, 1.2V, 1.25V, 1.8V, 2.048V, 2.5V and 3.3V
- Absolute Initial Accuracy Options. . . . . ±1.0mV, ±2.5mV, and ±5.0mV
- Supply Voltage Range
  - ISL60002-10, -11, -12, -18, -20, -25 . . . . . 2.7V to 5.5V
  - ISL60002-33 . . . . . 3.5V to 5.5V
- Ultra-Low Supply Current. . . . . 350nA typ
- Low 20ppm/°C Temperature Coefficient
- 10ppm/√1kHrs. Long Term Stability
- I<sub>SOURCE</sub> and I<sub>SINK</sub> = 7mA
- I<sub>SOURCE</sub> and I<sub>SINK</sub> = 20mA for ISL60002-33 only
- ESD Protection. . . . . 5kV (Human Body Model)
- Standard 3 Ld SOT-23 Packaging
- Operating Temperature Range
  - ISL60002-10, -11, -12, -18, -20, -25 . . . -40°C to +85°C
  - ISL60002-33 . . . . . -40°C to +105°C
- Pb-Free Plus Anneal Available (RoHS Compliant)

**Applications**

- High Resolution A/Ds and D/As
- Digital Meters
- Bar Code Scanners
- Mobile Communications
- PDA's and Notebooks
- Medical Systems

**Typical Application**

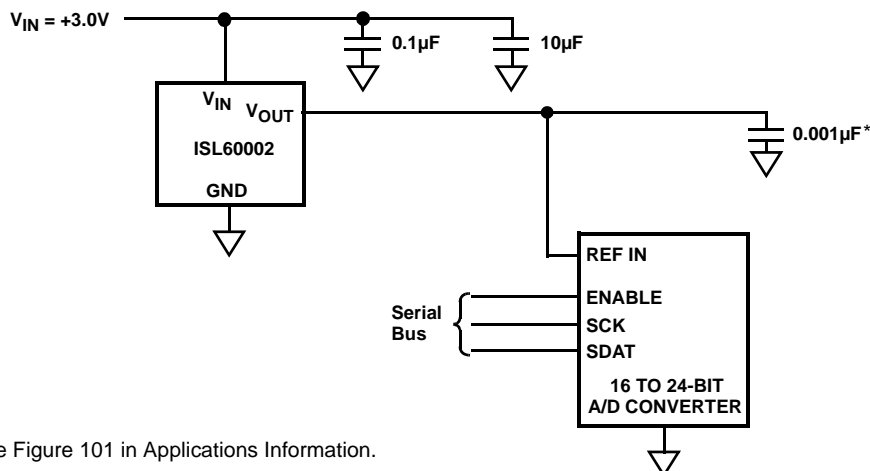

\*Also see Figure 101 in Applications Information.

**Table of Contents**

Typical Application.....	1
Pinout .....	3
Pin Descriptions .....	3
Ordering Information .....	3
Absolute Maximum Ratings.....	4
Electrical Specifications	
ISL60002-10, $V_{OUT} = 1.024V$ .....	4
ISL60002-11, $V_{OUT} = 1.200V$ .....	4
ISL60002-12, $V_{OUT} = 1.250V$ .....	4
ISL60002-18, $V_{OUT} = 1.800V$ .....	5
ISL60002-20, $V_{OUT} = 2.048V$ .....	5
ISL60002-25, $V_{OUT} = 2.500V$ .....	5
ISL60002-33, $V_{OUT} = 3.300V$ .....	5
Common Electrical Specifications	
ISL60002 -10, -11, -12, -18, -20, and -25 .....	6
Typical Performance Characteristic Curves	
ISL60002, $V_{OUT} = 1.024V$ .....	7
ISL60002, $V_{OUT} = 1.20V$ .....	10
ISL60002, $V_{OUT} = 1.25V$ .....	13
ISL60002, $V_{OUT} = 1.8V$ .....	16
ISL60002, $V_{OUT} = 2.048V$ .....	19
ISL60002, $V_{OUT} = 2.50V$ .....	22
ISL60002, $V_{OUT} = 3.3V$ .....	25
Applications Information.....	28
Typical Application Circuits.....	30
Packaging Information.....	31

# ISL60002

## Pinout

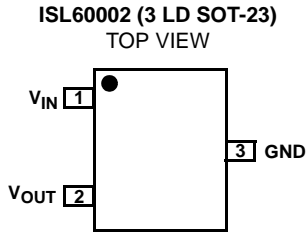

## Pin Descriptions

PIN NAME	DESCRIPTION
GND	Ground Connection
V <sub>IN</sub>	Power Supply Input Connection
V <sub>OUT</sub>	Voltage Reference Output Connection

## Ordering Information

PART NUMBER	PART MARKING	V <sub>OUT</sub> (V)	GRADE	TEMP. RANGE (°C)	PACKAGE
ISL60002BIH310Z-TK (Note)	DFB	1.024	±1.0mV, 20ppm/°C	-40 to +85	3 Ld SOT-23 (Pb-free)
ISL60002CIH310Z-TK (Note)	DFC	1.024	±2.5mV, 20ppm/°C	-40 to +85	3 Ld SOT-23 (Pb-free)
ISL60002DIH310Z-TK (Note)	DFD	1.024	±5.0mV, 20ppm/°C	-40 to +85	3 Ld SOT-23 (Pb-free)
ISL60002BIH311Z-TK (Note)	APM	1.200	±1.0mV, 20ppm/°C	-40 to +85	3 Ld SOT-23 (Pb-free)
ISL60002CIH311Z-TK (Note)	AOH	1.200	±2.5mV, 20ppm/°C	-40 to +85	3 Ld SOT-23 (Pb-free)
ISL60002DIH311Z-TK (Note)	AOY	1.200	±5.0mV, 20ppm/°C	-40 to +85	3 Ld SOT-23 (Pb-free)
ISL60002BIH312-TK	AIL	1.250	±1.0mV, 20ppm/°C	-40 to +85	3 Ld SOT-23
ISL60002BIH312Z-TK (Note)	AOM	1.250	±1.0mV, 20ppm/°C	-40 to +85	3 Ld SOT-23 (Pb-free)
ISL60002CIH312-TK	AIN	1.250	±2.5mV, 20ppm/°C	-40 to +85	3 Ld SOT-23
ISL60002CIH312Z-TK (Note)	AOS	1.250	±2.5mV, 20ppm/°C	-40 to +85	3 Ld SOT-23 (Pb-free)
ISL60002DIH312-TK	AIP	1.250	±5.0mV, 20ppm/°C	-40 to +85	3 Ld SOT-23
ISL60002DIH312Z-TK (Note)	APA	1.250	±5.0mV, 20ppm/°C	-40 to +85	3 Ld SOT-23 (Pb-free)
ISL60002BIH318Z-TK (Note)	DEO	1.800	±1.0mV, 20ppm/°C	-40 to +85	3 Ld SOT-23 (Pb-free)
ISL60002CIH318Z-TK (Note)	DEP	1.800	±2.5mV, 20ppm/°C	-40 to +85	3 Ld SOT-23 (Pb-free)
ISL60002DIH318Z-TK (Note)	DEQ	1.800	±5.0mV, 20ppm/°C	-40 to +85	3 Ld SOT-23 (Pb-free)
ISL60002BIH320Z-TK (Note)	DEY	2.048	±1.0mV, 20ppm/°C	-40 to +85	3 Ld SOT-23 (Pb-free)
ISL60002CIH320Z-TK (Note)	DEZ	2.048	±2.5mV, 20ppm/°C	-40 to +85	3 Ld SOT-23 (Pb-free)
ISL60002DIH320Z-TK (Note)	DFA	2.048	±5.0mV, 20ppm/°C	-40 to +85	3 Ld SOT-23 (Pb-free)
ISL60002BIH325-TK	AIK	2.500	±1.0mV, 20ppm/°C	-40 to +85	3 Ld SOT-23
ISL60002BIH325Z-TK (Note)	AON	2.500	±1.0mV, 20ppm/°C	-40 to +85	3 Ld SOT-23 (Pb-free)
ISL60002CIH325-TK	AIM	2.500	±2.5mV, 20ppm/°C	-40 to +85	3 Ld SOT-23
ISL60002CIH325Z-TK (Note)	AOT	2.500	±2.5mV, 20ppm/°C	-40 to +85	3 Ld SOT-23 (Pb-free)
ISL60002DIH325-TK	AIO	2.500	±5.0mV, 20ppm/°C	-40 to +85	3 Ld SOT-23
ISL60002DIH325Z-TK (Note)	APB	2.500V	±5.0mV, 20ppm/°C	-40 to +85	3 Ld SOT-23 (Pb-free)
ISL60002BAH333Z-TK (Note)	AOP	3.300V	±1.0mV, 20ppm/°C	-40 to +105	3 Ld SOT-23 (Pb-free)
ISL60002CAH333Z-TK (Note)	AOU	3.300V	±2.5mV, 20ppm/°C	-40 to +105	3 Ld SOT-23 (Pb-free)
ISL60002DAH333Z-TK (Note)	APC	3.300V	±5.0mV, 20ppm/°C	-40 to +105	3 Ld SOT-23 (Pb-free)

\*Add "TK" suffix for tape and reel.

NOTE: Intersil Pb-free plus anneal products employ special Pb-free material sets; molding compounds/die attach materials and 100% matte tin plate termination finish, which are RoHS compliant and compatible with both SnPb and Pb-free soldering operations. Intersil Pb-free products are MSL classified at Pb-free peak reflow temperatures that meet or exceed the Pb-free requirements of IPC/JEDEC J STD-020.

**Absolute Maximum Ratings**

Storage Temperature Range . . . . . -65°C to + 150°C  
 Max Voltage  $V_{IN}$  to Gnd. . . . . -0.5V to +6.5V  
 Max Voltage  $V_{OUT}$  to Gnd\*:  
 ISL60002,  $V_{OUT} = 1.25V$  . . . . . -0.5V to +2.25V  
 ISL60002,  $V_{OUT} = 2.50V$  . . . . . -0.5V to +3.50V  
 Voltage on “DNC” pins . . . . . No connections permitted to these pins.  
 Lead Temperature, Soldering\*(Note 5) . . . . . +225°C  
 \*Maximum duration = 10s

**Recommended Operating Conditions**

Temperature Range (Industrial) . . . . . -40°C to +85°C  
 Temperature Range (3.3V version) . . . . . -40°C to +105°C

**ESD Ratings**

MIL-STD-883, Method 3014 . . . . . ≥5kV

*CAUTION: Absolute Maximum Ratings are limits which may result in impaired reliability and/or permanent damage to the device. These are stress ratings provided for information only and functional operation of the device at these or any other conditions beyond those indicated in the operational sections of this specification are not implied.*

*For guaranteed specifications and test conditions, see Electrical Specifications.*

*The guaranteed specifications apply only for the test conditions listed. Some performance characteristics may degrade when the device is not operated under the listed test conditions.*

**Electrical Specifications ISL60002-10,  $V_{OUT} = 1.024V$**  (Additional specifications on page 6, “Common Electrical Specifications”) Operating Conditions:  $V_{IN} = 3.0V$ ,  $I_{OUT} = 0mA$ ,  $C_{OUT} = 0.001\mu F$ ,  $T_A = -40$  to +85°C, unless otherwise specified.

SYMBOL	PARAMETER	CONDITIONS	MIN	TYP	MAX	UNITS
$V_{OUT}$	Output Voltage			1.024		V
$V_{OA}$	$V_{OUT}$ Accuracy (Note 5)	$T_A = +25^\circ C$				
		ISL60002B10	-1.0		+1.0	mV
		ISL60002C10	-2.5		+2.5	mV
		ISL60002D10	-5.0		+5.0	mV
$V_{IN}$	Input Voltage Range		2.7		5.5	V

**Electrical Specifications ISL60002-11,  $V_{OUT} = 1.200V$**  (Additional specifications on page 6, “Common Electrical Specifications”) Operating Conditions:  $V_{IN} = 3.0V$ ,  $I_{OUT} = 0mA$ ,  $C_{OUT} = 0.001\mu F$ ,  $T_A = -40$  to +85°C, unless otherwise specified.

SYMBOL	PARAMETER	CONDITIONS	MIN	TYP	MAX	UNITS
$V_{OUT}$	Output Voltage			1.200		V
$V_{OA}$	$V_{OUT}$ Accuracy (Note 5)	$T_A = +25^\circ C$				
		ISL60002B11	-1.0		+1.0	mV
		ISL60002C11	-2.5		+2.5	mV
		ISL60002D11	-5.0		+5.0	mV
$V_{IN}$	Input Voltage Range		2.7		5.5	V

**Electrical Specifications ISL60002-12,  $V_{OUT} = 1.250V$**  (Additional specifications on page 6, “Common Electrical Specifications”) Operating Conditions:  $V_{IN} = 3.0V$ ,  $I_{OUT} = 0mA$ ,  $C_{OUT} = 0.001\mu F$ ,  $T_A = -40$  to +85°C, unless otherwise specified.

SYMBOL	PARAMETER	CONDITIONS	MIN	TYP	MAX	UNITS
$V_{OUT}$	Output Voltage			1.250		V
$V_{OA}$	$V_{OUT}$ Accuracy (Note 5)	$T_A = +25^\circ C$				
		ISL60002B12	-1.0		+1.0	mV
		ISL60002C12	-2.5		+2.5	mV
		ISL60002D12	-5.0		+5.0	mV
$V_{IN}$	Input Voltage Range		2.7		5.5	V

## ISL60002

**Electrical Specifications ISL60002-18,  $V_{OUT} = 1.800V$**  (Additional specifications on page 6, "Common Electrical Specifications")  
 Operating Conditions:  $V_{IN} = 3.0V$ ,  $I_{OUT} = 0mA$ ,  $C_{OUT} = 0.001\mu F$ ,  $T_A = -40$  to  $+85^\circ C$ , unless otherwise specified.

SYMBOL	PARAMETER	CONDITIONS	MIN	TYP	MAX	UNITS
$V_{OUT}$	Output Voltage			1.800		V
$V_{OA}$	$V_{OUT}$ Accuracy (Note 5)	$T_A = +25^\circ C$				
		ISL60002B18	-1.0		+1.0	mV
		ISL60002C18	-2.5		+2.5	mV
		ISL60002D18	-5.0		+5.0	mV
$V_{IN}$	Input Voltage Range		2.7		5.5	V

**Electrical Specifications ISL60002-20,  $V_{OUT} = 2.048V$**  (Additional specifications on page 6, "Common Electrical Specifications")  
 Operating Conditions:  $V_{IN} = 3.0V$ ,  $I_{OUT} = 0mA$ ,  $C_{OUT} = 0.001\mu F$ ,  $T_A = -40$  to  $+85^\circ C$ , unless otherwise specified.

SYMBOL	PARAMETER	CONDITIONS	MIN	TYP	MAX	UNITS
$V_{OUT}$	Output Voltage			2.048		V
$V_{OA}$	$V_{OUT}$ Accuracy (Note 5)	$T_A = +25^\circ C$				
		ISL60002B20	-1.0		+1.0	mV
		ISL60002C20	-2.5		+2.5	mV
		ISL60002D20	-5.0		+5.0	mV
$V_{IN}$	Input Voltage Range		2.7		5.5	V

**Electrical Specifications ISL60002-25,  $V_{OUT} = 2.500V$**  (Additional specifications on page 6, "Common Electrical Specifications")  
 Operating Conditions:  $V_{IN} = 3.0V$ ,  $I_{OUT} = 0mA$ ,  $C_{OUT} = 0.001\mu F$ ,  $T_A = -40$  to  $+85^\circ C$ , unless otherwise specified.

SYMBOL	PARAMETER	CONDITIONS	MIN	TYP	MAX	UNITS
$V_{OUT}$	Output Voltage			2.500		V
$V_{OA}$	$V_{OUT}$ Accuracy (Note 5)	$T_A = +25^\circ C$				
		ISL60002B25	-1.0		+1.0	mV
		ISL60002C25	-2.5		+2.5	mV
		ISL60002D25	-5.0		+5.0	mV
$V_{IN}$	Input Voltage Range		2.7		5.5	V

**Electrical Specifications ISL60002-33,  $V_{OUT} = 3.300V$**

Operating Conditions:  $V_{IN} = 5.0V$ ,  $I_{OUT} = 0mA$ ,  $C_{OUT} = 0.001\mu F$ ,  $T_A = -40$  to  $+105^\circ C$ , unless otherwise specified.

SYMBOL	PARAMETER	CONDITIONS	MIN	TYP	MAX	UNITS
$V_{OUT}$	Output Voltage			3.300		V
$V_{OA}$	$V_{OUT}$ Accuracy (Note 5)	$T_A = +25^\circ C$				
		ISL60002B33	-1.0		1.0	mV
		ISL60002C33	-2.5		2.5	mV
		ISL60002D33	-5.0		5.0	mV
$TC V_{OUT}$	Output Voltage Temperature Coefficient (Note 1)				20	ppm/ $^\circ C$
$V_{IN}$	Input Voltage Range		3.5		5.5	V
$I_{IN}$	Supply Current			350	700	nA
$\Delta V_{OUT}/\Delta V_{IN}$	Line Regulation	$+3.5V \leq V_{IN} \leq +5.5V$		80	200	$\mu V/V$
$\Delta V_{OUT}/\Delta I_{OUT}$	Load Regulation	$0mA \leq I_{SOURCE} \leq 20mA$		25	100	$\mu V/mA$
		$-20mA \leq I_{SINK} \leq 0mA$		50	150	$\mu V/mA$

## ISL60002

### Electrical Specifications ISL60002-33, $V_{OUT} = 3.300V$ (Continued)

Operating Conditions:  $V_{IN} = 5.0V$ ,  $I_{OUT} = 0mA$ ,  $C_{OUT} = 0.001\mu F$ ,  $T_A = -40$  to  $+105^\circ C$ , unless otherwise specified.

SYMBOL	PARAMETER	CONDITIONS	MIN	TYP	MAX	UNITS
$\Delta V_{OUT}/\Delta t$	Long Term Stability (Note 4)	$T_A = +25^\circ C$		10		ppm/ $\sqrt{1}$ kHrs
$\Delta V_{OUT}/\Delta T_A$	Thermal Hysteresis (Note 2)	$\Delta T_A = +145^\circ C$		100		ppm
$I_{SC}$	Short Circuit Current (Note 3)	$T_A = +25^\circ C$		50	80	mA
$V_N$	Output Voltage Noise	$0.1Hz \leq f \leq 10Hz$		30		$\mu V_{p-p}$

### Common Electrical Specifications ISL60002 -10, -11, -12, -18, -20, and -25

Operating Conditions:  $V_{IN} = 3.0V$ ,  $I_{OUT} = 0mA$ ,  $C_{OUT} = 0.001\mu F$ ,  $T_A = -40$  to  $+85^\circ C$ , unless otherwise specified

SYMBOL	PARAMETER	CONDITIONS	MIN	TYP	MAX	UNITS
TC $V_{OUT}$	Output Voltage Temperature Coefficient (Note 1)				20	ppm/ $^\circ C$
$I_{IN}$	Supply Current			350	900	nA
$\Delta V_{OUT}/\Delta V_{IN}$	Line Regulation	$+2.7V \leq V_{IN} \leq +5.5V$		80	250	$\mu V/V$
$\Delta V_{OUT}/\Delta I_{OUT}$	Load Regulation	$0mA \leq I_{SOURCE} \leq 7mA$		25	100	$\mu V/mA$
		$-7mA \leq I_{SINK} \leq 0mA$		50	150	$\mu V/mA$
$\Delta V_{OUT}/\Delta t$	Long Term Stability (Note 4)	$T_A = +25^\circ C$		10		ppm/ $\sqrt{1}$ kHrs
$\Delta V_{OUT}/\Delta T_A$	Thermal Hysteresis (Note 2)	$\Delta T_A = +125^\circ C$		100		ppm
$I_{SC}$	Short Circuit Current (Note 3)	$T_A = +25^\circ C$		50	80	mA
$V_N$	Output Voltage Noise	$0.1Hz \leq f \leq 10Hz$		30		$\mu V_{p-p}$

#### NOTES:

- Over the specified temperature range. Temperature coefficient is measured by the box method whereby the change in  $V_{OUT}$  is divided by the temperature range:  $(-40^\circ C$  to  $+85^\circ C = +125^\circ C$ , or  $-40^\circ C$  to  $+105^\circ C = +145^\circ C$  for the ISL60002-33).
- Thermal Hysteresis is the change in  $V_{OUT}$  measured @  $T_A = +25^\circ C$  after temperature cycling over a specified range,  $\Delta T_A$ .  $V_{OUT}$  is read initially at  $T_A = +25^\circ C$  for the device under test. The device is temperature cycled and a second  $V_{OUT}$  measurement is taken at  $+25^\circ C$ . The difference between the initial  $V_{OUT}$  reading and the second  $V_{OUT}$  reading is then expressed in ppm. For  $\Delta T_A = +125^\circ C$ , the device under is cycled from  $+25^\circ C$  to  $+85^\circ C$  to  $-40^\circ C$  to  $+25^\circ C$ , and for  $\Delta T_A = +145^\circ C$ , the device under is cycled from  $+25^\circ C$  to  $+105^\circ C$  to  $-40^\circ C$  to  $+25^\circ C$
- Guaranteed by device characterization and/or correlation to other device tests.
- FGA™ voltage reference long term drift is a logarithmic characteristic. Changes that occur after the first few hundred hours of operation are significantly smaller with time, asymptotically approaching zero beyond 2000 hours. Because of this decreasing characteristic, long-term drift is specified in ppm/ $\sqrt{1}$ kHr.
- Pb-free manufacturing can result in solder reflow temperatures exceeding the  $+225^\circ C$  absolute maximum. Exposing the device to this reflow temperature will not damage it or cause any functional issues and the device will operate normally. The high reflow temperature may result in a permanent shift in output voltage of  $500\mu V$  to  $1.0mV$  depending on the temperature and exposure time. If possible, using a reduced reflow temperature in production will result in the best possible output voltage accuracy.

**Typical Performance Characteristic Curves ISL60002,  $V_{OUT} = 1.024V$**

$V_{IN} = 3.0V$ ,  $I_{OUT} = 0mA$ ,  $T_A = +25^\circ C$  unless otherwise specified

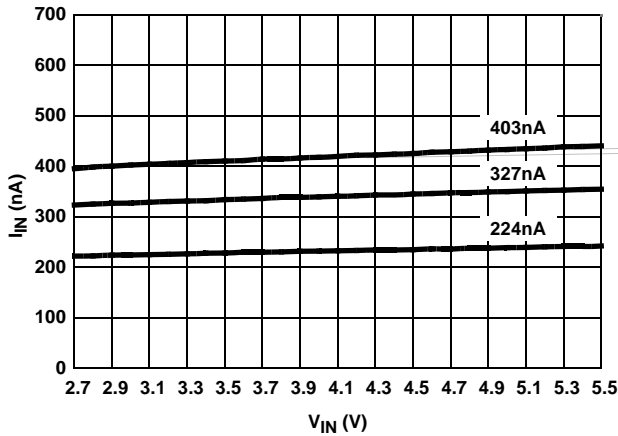

FIGURE 1.  $I_{IN}$  vs  $V_{IN}$  (3 REPRESENTATIVE UNITS)

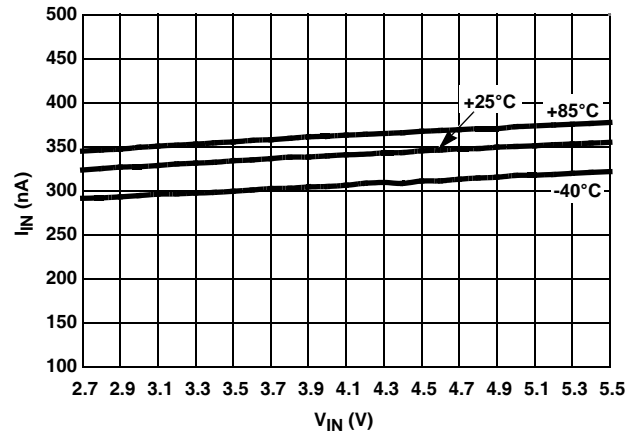

FIGURE 2.  $I_{IN}$  vs  $V_{IN}$  OVER TEMPERATURE

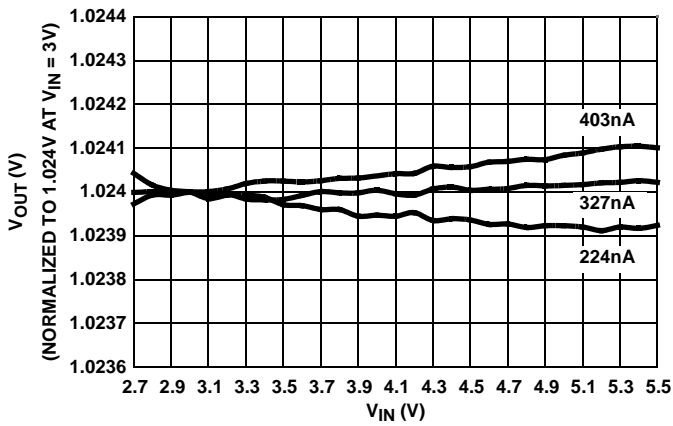

FIGURE 3. LINE REGULATION (3 REPRESENTATIVE UNITS)

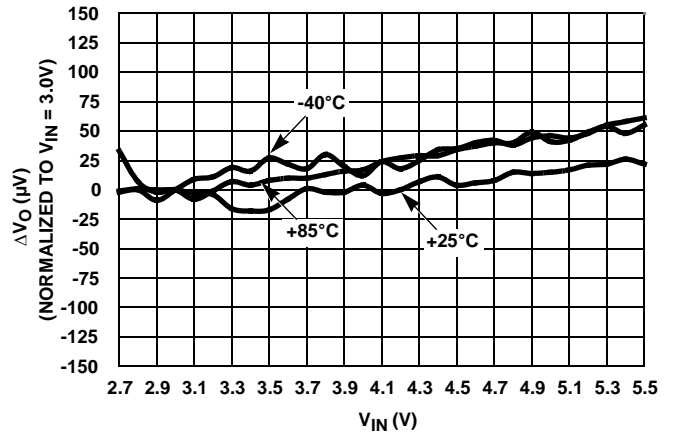

FIGURE 4. LINE REGULATION OVER TEMPERATURE

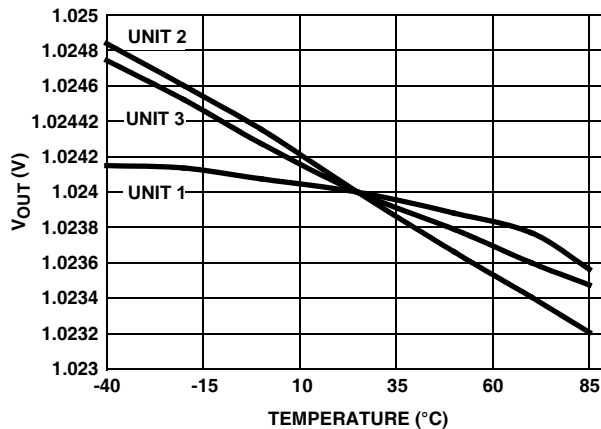

FIGURE 5.  $V_{OUT}$  vs TEMPERATURE NORMALIZED TO  $+25^\circ C$

**Typical Performance Characteristic Curves ISL60002,  $V_{OUT} = 1.024V$**  (Continued)

$V_{IN} = 3.0V$ ,  $I_{OUT} = 0mA$ ,  $T_A = +25^{\circ}C$  unless otherwise specified

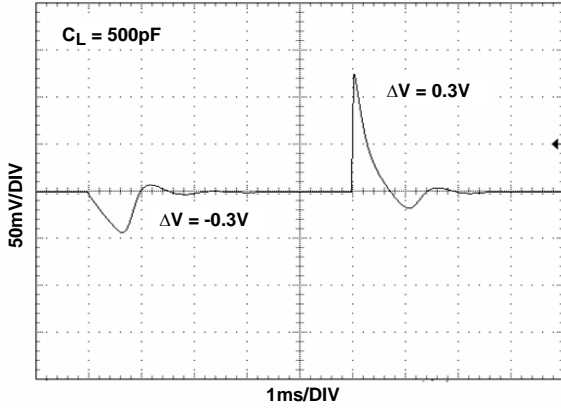

FIGURE 6. LINE TRANSIENT RESPONSE

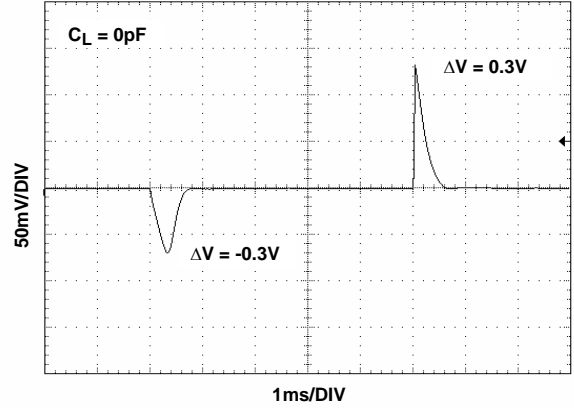

FIGURE 7. NO LOAD LINE TRANSIENT RESPONSE

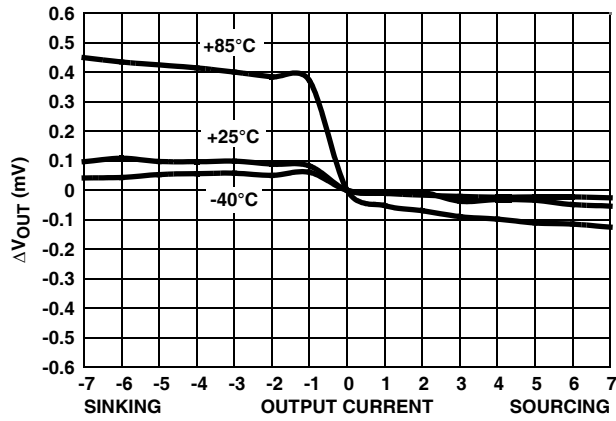

FIGURE 8. LOAD REGULATION

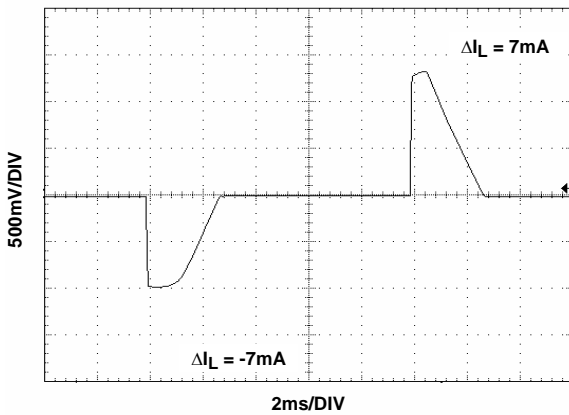

FIGURE 9. LOAD TRANSIENT RESPONSE

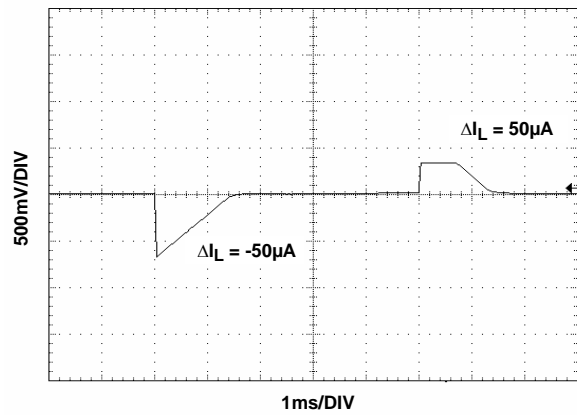

FIGURE 10. LOAD TRANSIENT RESPONSE



**Typical Performance Characteristic Curves ISL60002,  $V_{OUT} = 1.024V$**  (Continued)

$V_{IN} = 3.0V$ ,  $I_{OUT} = 0mA$ ,  $T_A = +25^{\circ}C$  unless otherwise specified

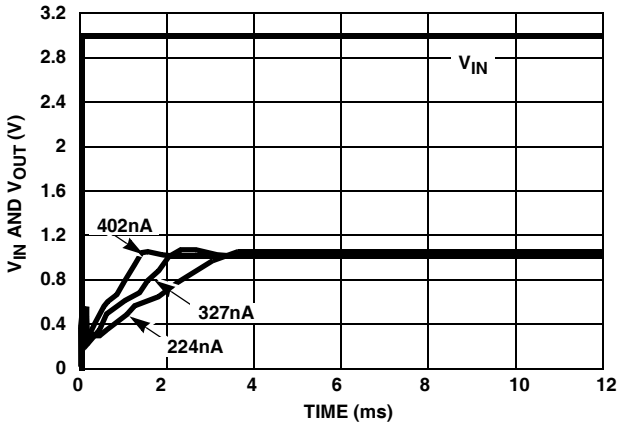

FIGURE 11. TURN-ON TIME (+25°C)

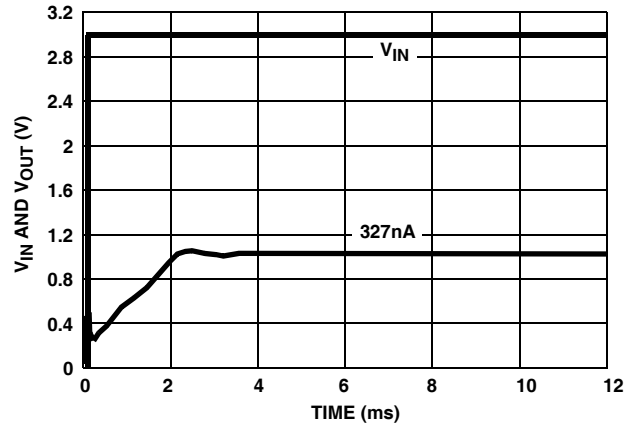

FIGURE 12. TURN-ON TIME (+25°C)

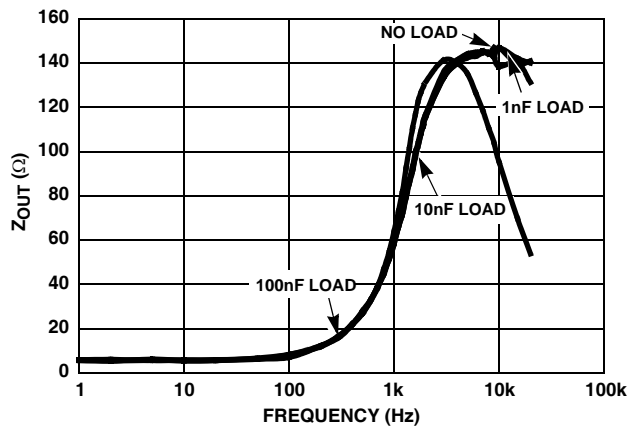

FIGURE 13.  $Z_{OUT}$  vs FREQUENCY

**Typical Performance Characteristic Curves ISL60002,  $V_{OUT} = 1.20V$**

$V_{IN} = 3.0V$ ,  $I_{OUT} = 0mA$ ,  $T_A = +25^\circ C$  unless otherwise specified

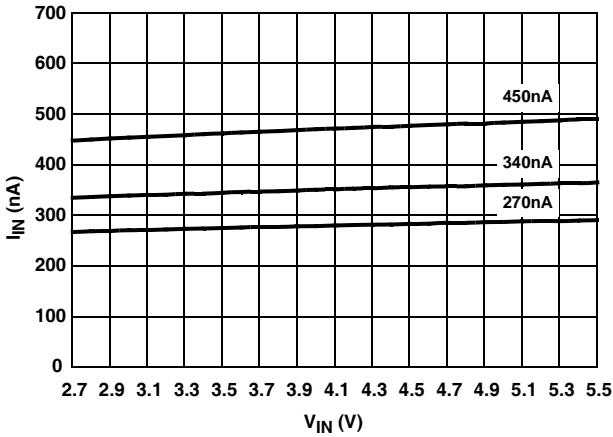

FIGURE 14.  $I_{IN}$  vs  $V_{IN}$  (3 REPRESENTATIVE UNITS)

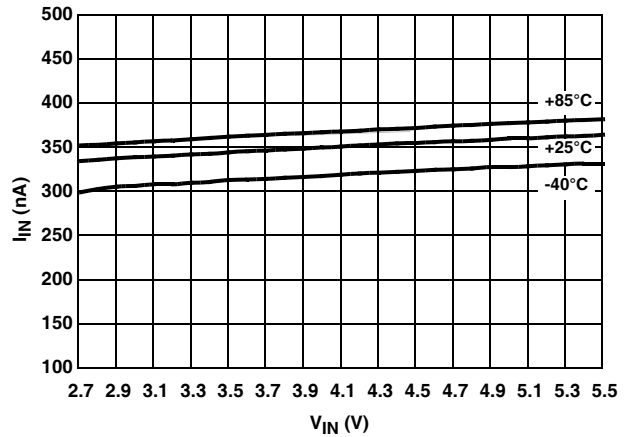

FIGURE 15.  $I_{IN}$  vs  $V_{IN}$  OVER TEMPERATURE

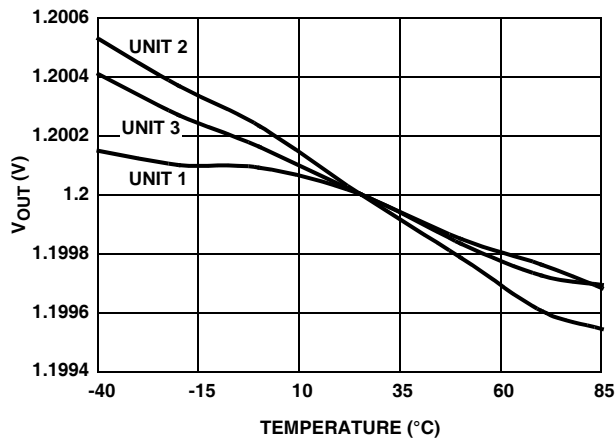

FIGURE 16.  $V_{OUT}$  vs TEMPERATURE NORMALIZED to  $+25^\circ C$

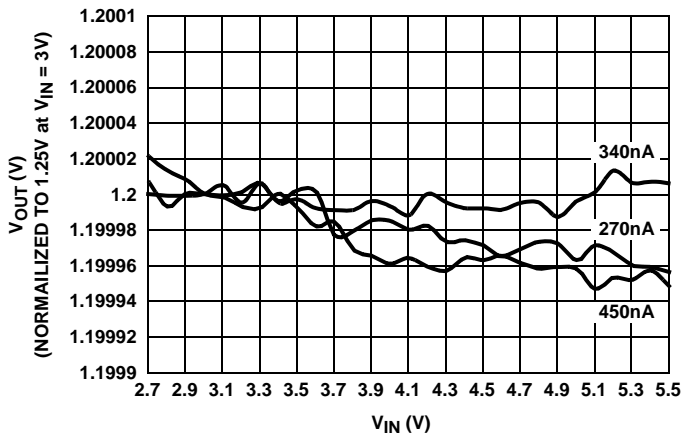

FIGURE 17. LINE REGULATION (3 REPRESENTATIVE UNITS)

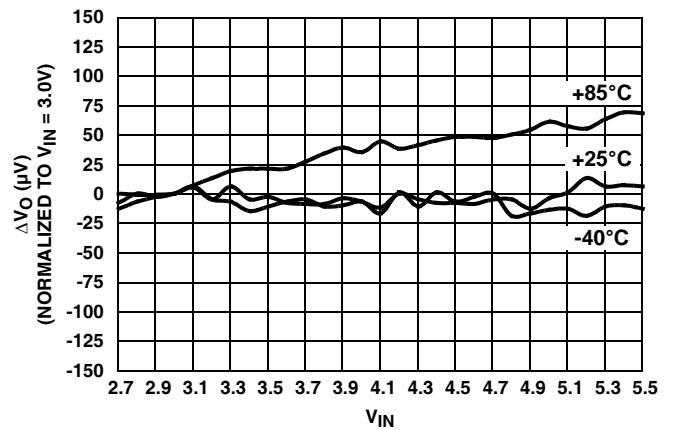

FIGURE 18. LINE REGULATION OVER TEMPERATURE

Typical Performance Characteristic Curves ISL60002,  $V_{OUT} = 1.20V$  (Continued)

$V_{IN} = 3.0V$ ,  $I_{OUT} = 0mA$ ,  $T_A = +25^\circ C$  unless otherwise specified

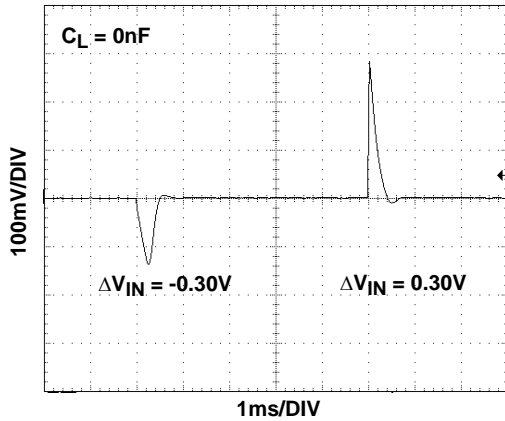

FIGURE 19. LINE TRANSIENT RESPONSE

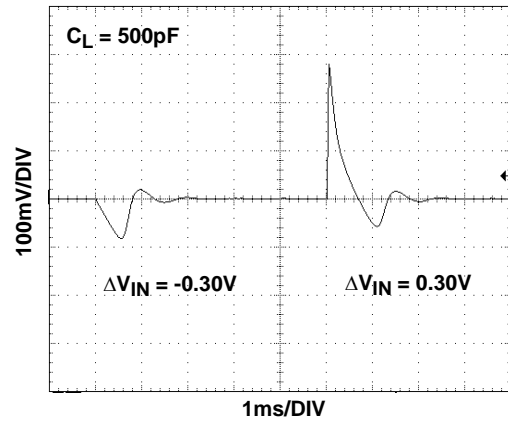

FIGURE 20. LINE TRANSIENT RESPONSE

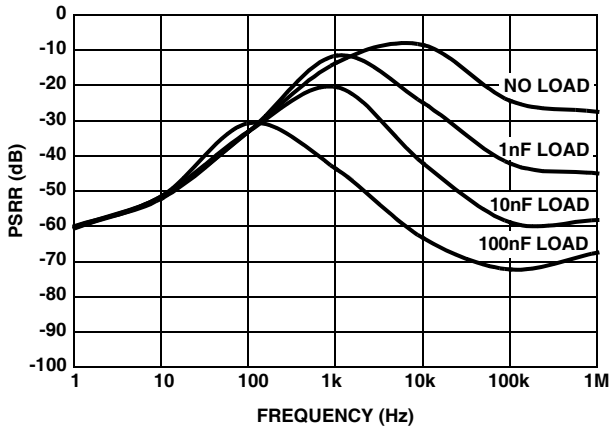

FIGURE 21. PSRR vs CAPACITIVE LOAD

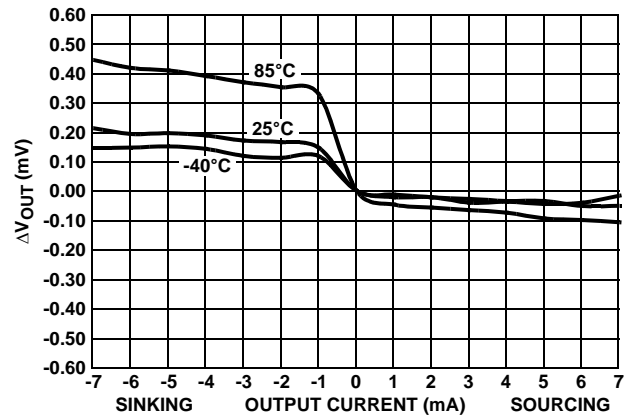

FIGURE 22. LOAD REGULATION

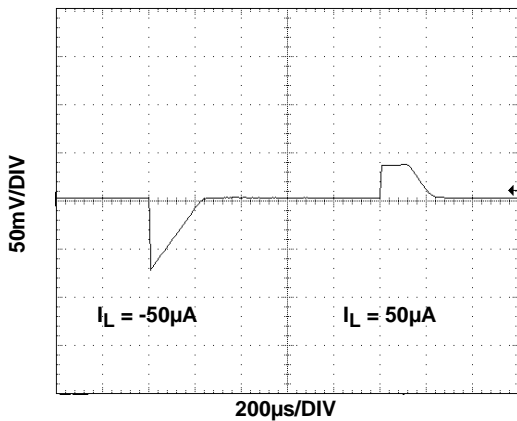

FIGURE 23. LOAD TRANSIENT RESPONSE

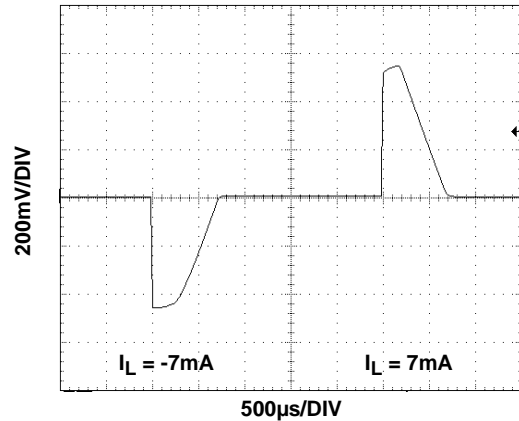

FIGURE 24. LOAD TRANSIENT RESPONSE

**Typical Performance Characteristic Curves ISL60002,  $V_{OUT} = 1.20V$  (Continued)**

$V_{IN} = 3.0V$ ,  $I_{OUT} = 0mA$ ,  $T_A = +25^{\circ}C$  unless otherwise specified



FIGURE 25. TURN-ON TIME (+25°C)

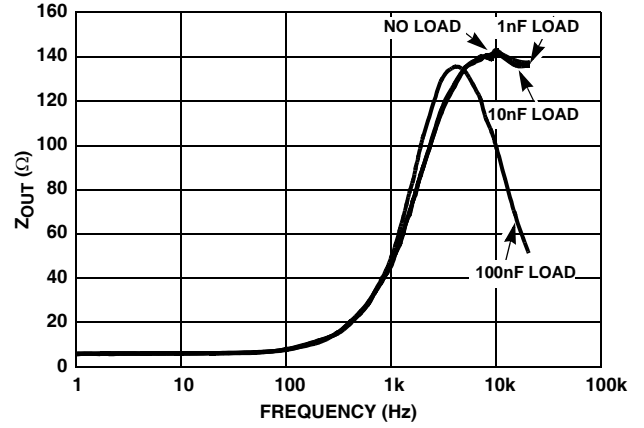

FIGURE 26.  $Z_{OUT}$  vs FREQUENCY

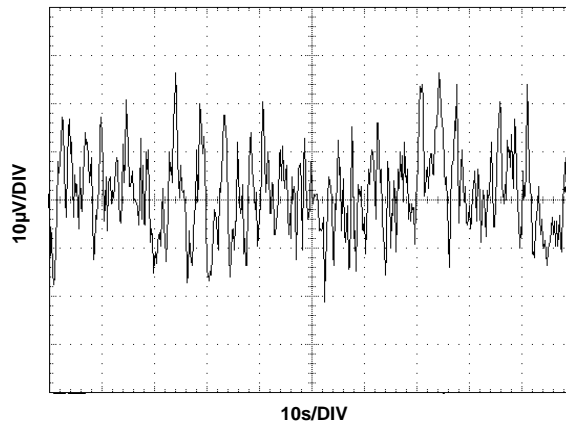

FIGURE 27.  $V_{OUT}$  NOISE

**Typical Performance Characteristic Curves ISL60002,  $V_{OUT} = 1.25V$**

$V_{IN} = 3.0V$ ,  $I_{OUT} = 0mA$ ,  $T_A = +25^{\circ}C$  unless otherwise specified

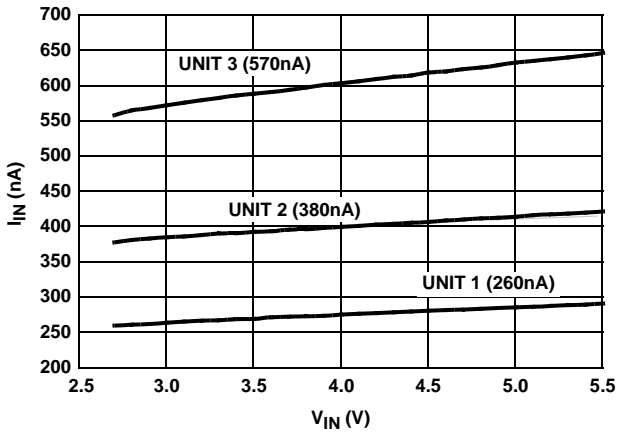

FIGURE 28.  $I_{IN}$  vs  $V_{IN}$  (3 REPRESENTATIVE UNITS)

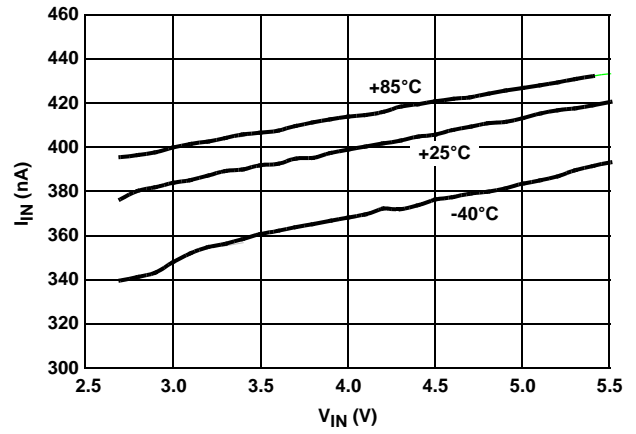

FIGURE 29.  $I_{IN}$  vs  $V_{IN}$  OVER TEMPERATURE

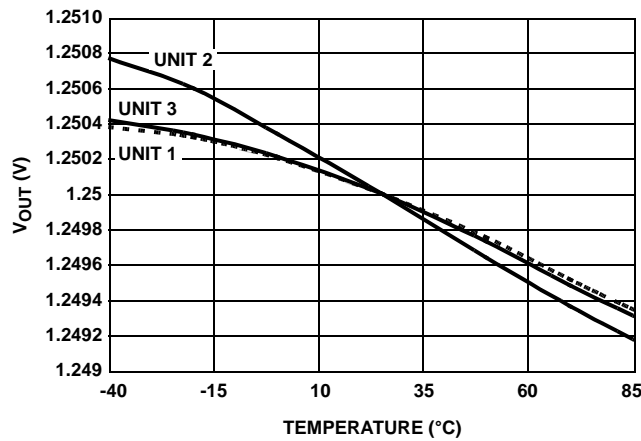

FIGURE 30.  $V_{OUT}$  vs TEMPERATURE NORMALIZED TO  $+25^{\circ}C$

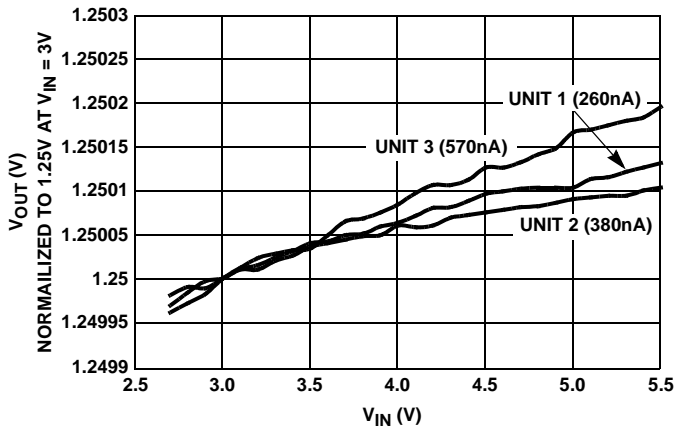

FIGURE 31. LINE REGULATION (3 REPRESENTATIVE UNITS)

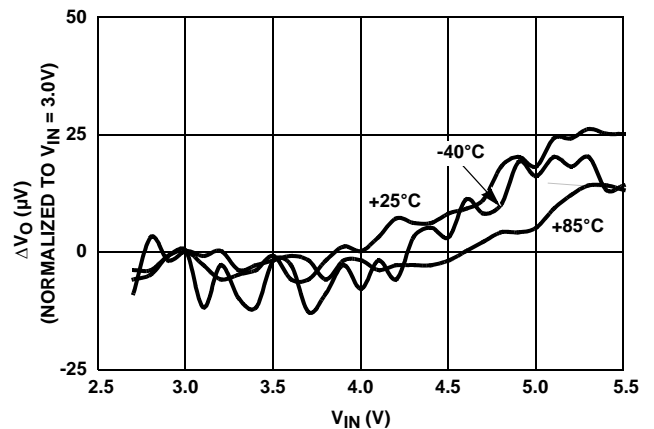

FIGURE 32. LINE REGULATION OVER TEMPERATURE

**Typical Performance Characteristic Curves ISL60002,  $V_{OUT} = 1.25V$**  (Continued)

$V_{IN} = 3.0V$ ,  $I_{OUT} = 0mA$ ,  $T_A = +25^\circ C$  unless otherwise specified

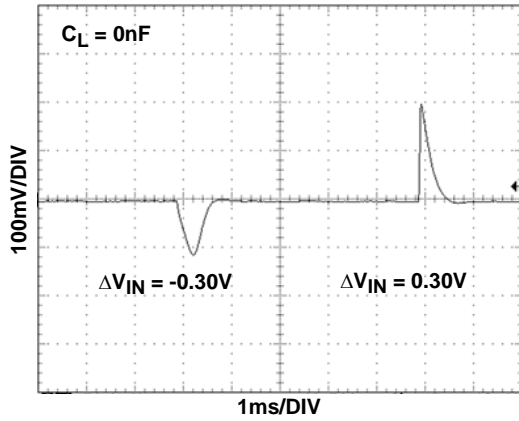

FIGURE 33. LINE TRANSIENT RESPONSE

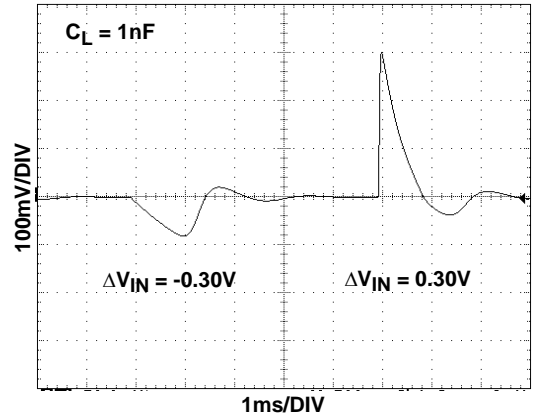

FIGURE 34. LINE TRANSIENT RESPONSE

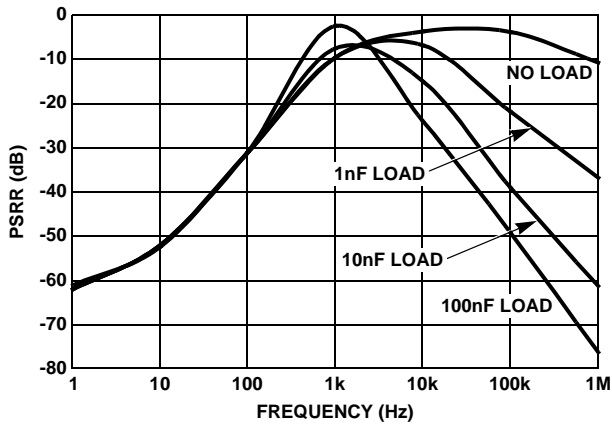

FIGURE 35. PSRR vs CAPACITIVE LOAD

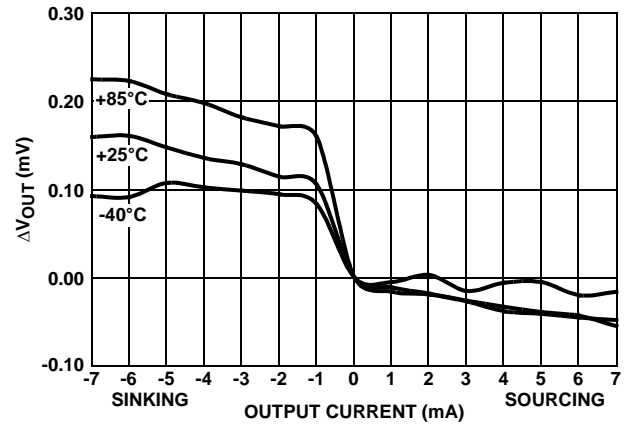

FIGURE 36. LOAD REGULATION

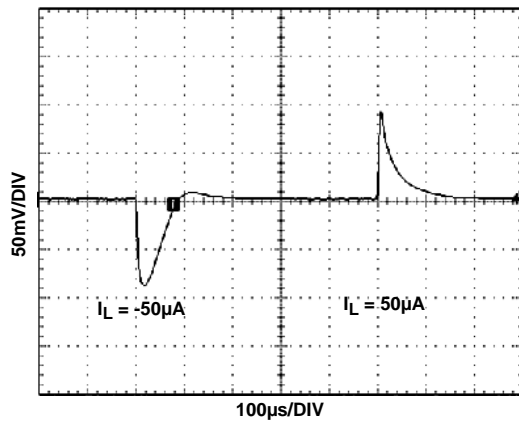

FIGURE 37. LOAD TRANSIENT RESPONSE

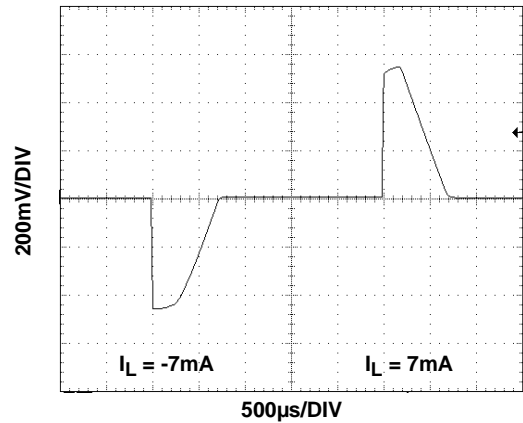

FIGURE 38. LOAD TRANSIENT RESPONSE

**Typical Performance Characteristic Curves ISL60002,  $V_{OUT} = 1.25V$  (Continued)**

$V_{IN} = 3.0V$ ,  $I_{OUT} = 0mA$ ,  $T_A = +25^{\circ}C$  unless otherwise specified

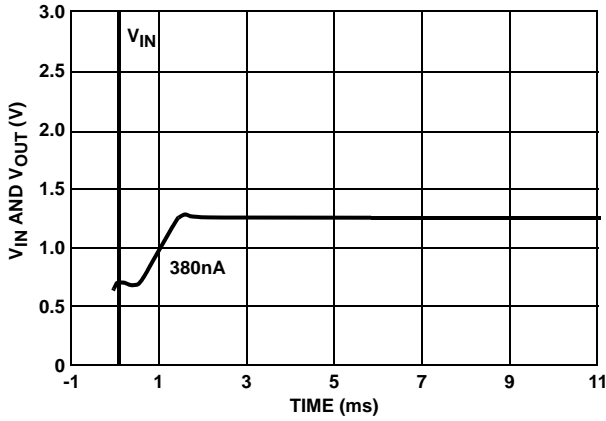

FIGURE 39. TURN-ON TIME (+25°C)

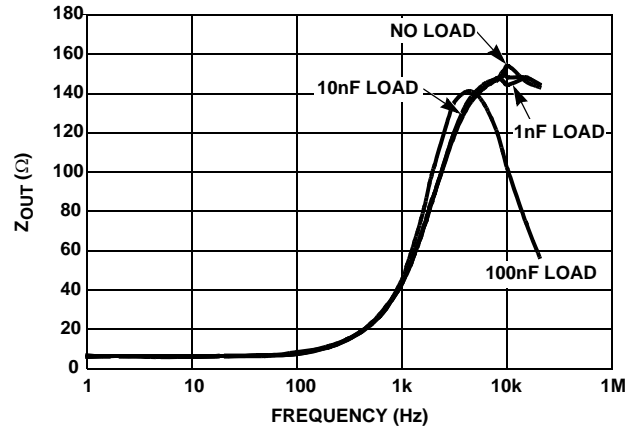

FIGURE 40.  $Z_{OUT}$  vs FREQUENCY

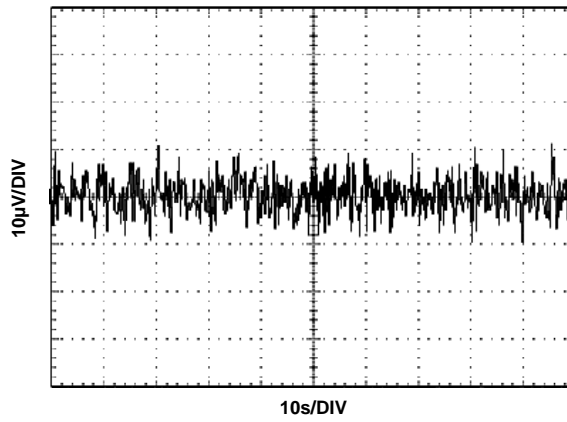

FIGURE 41.  $V_{OUT}$  NOISE

**Typical Performance Curves ISL60002,  $V_{OUT} = 1.8V$**

$V_{IN} = 3.0V$ ,  $I_{OUT} = 0mA$ ,  $T_A = +25^{\circ}C$  unless otherwise specified

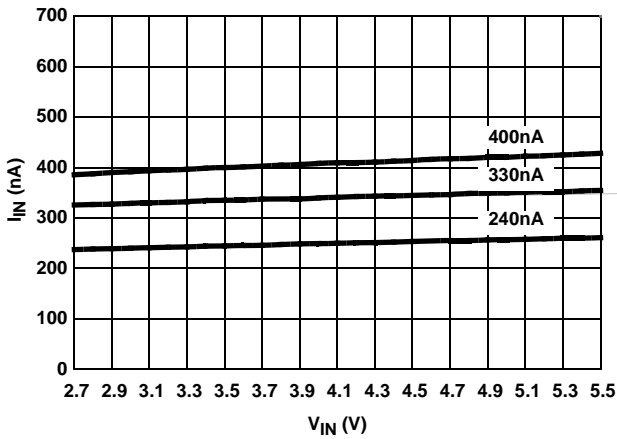

FIGURE 42.  $I_{IN}$  vs  $V_{IN}$  (3 REPRESENTATIVE UNITS)

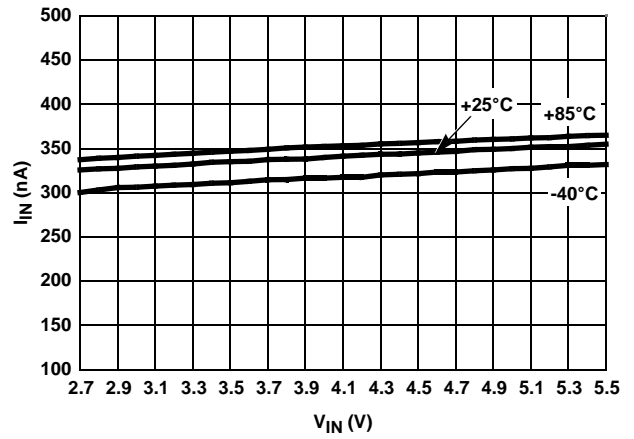

FIGURE 43.  $I_{IN}$  vs  $V_{IN}$  OVER TEMPERATURE

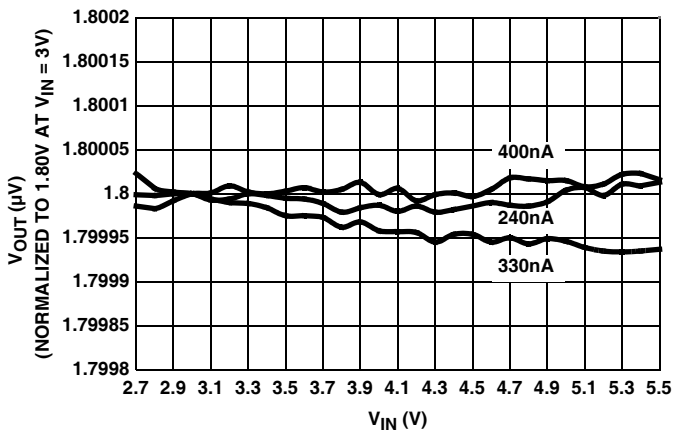

FIGURE 44. LINE REGULATION (3 REPRESENTATIVE UNITS)

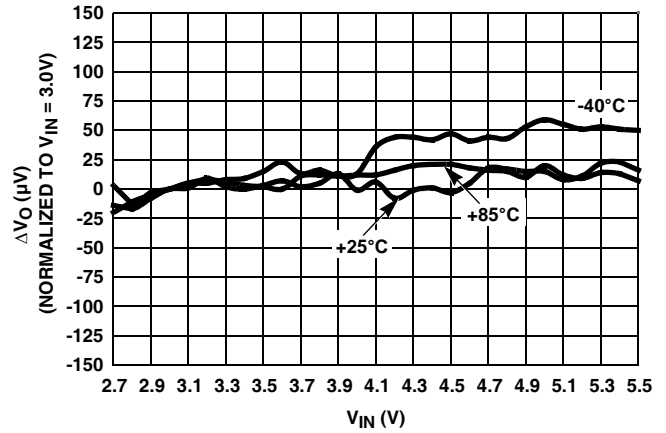

FIGURE 45. LINE REGULATION OVER TEMPERATURE

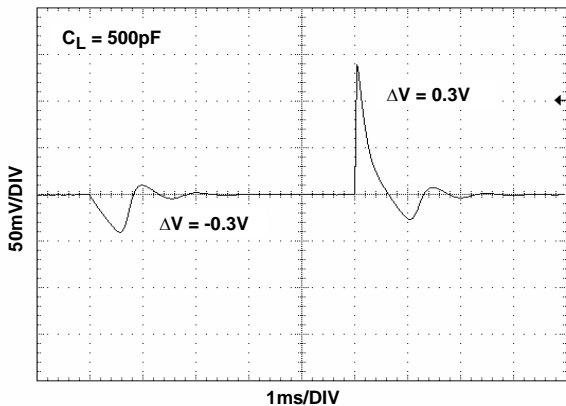

FIGURE 46. LINE TRANSIENT RESPONSE

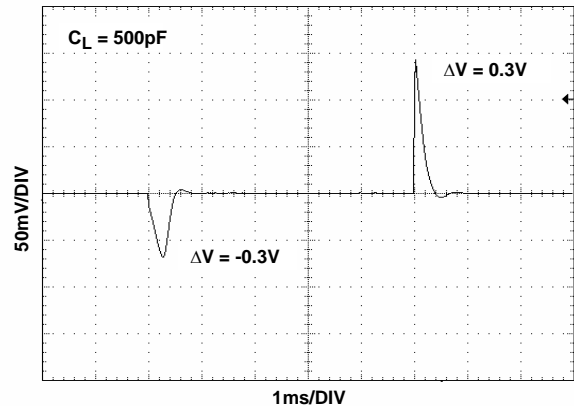

FIGURE 47. NO LOAD LINE TRANSIENT RESPONSE



Typical Performance Curves ISL60002,  $V_{OUT} = 1.8V$  (Continued)

$V_{IN} = 3.0V$ ,  $I_{OUT} = 0mA$ ,  $T_A = +25^{\circ}C$  unless otherwise specified

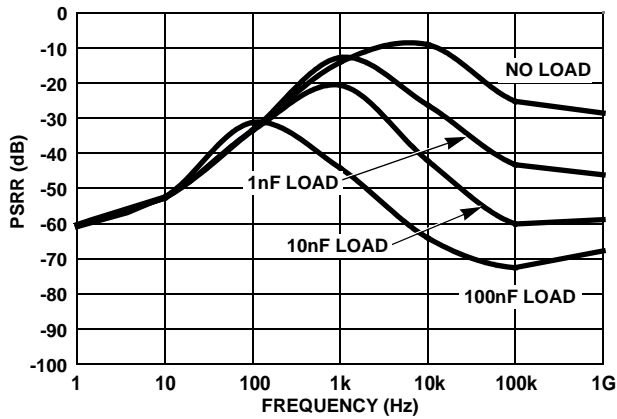

FIGURE 48. PSRR vs CAPACITIVE LOAD

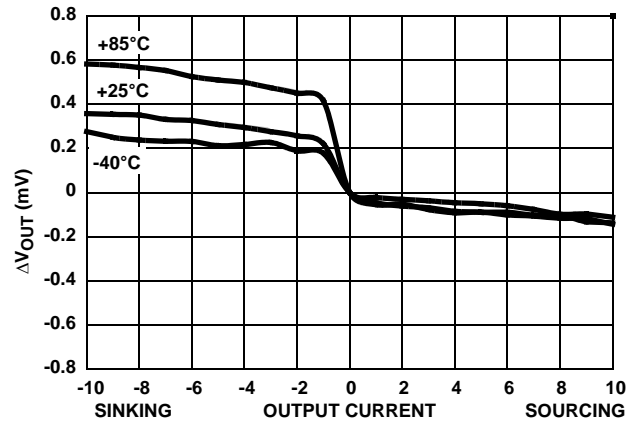

FIGURE 49. LOAD REGULATION

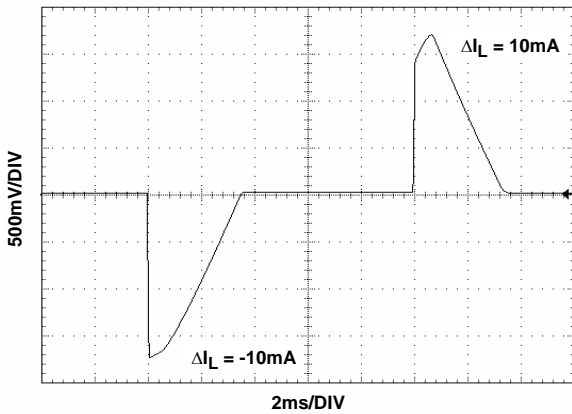

FIGURE 50. LOAD TRANSIENT RESPONSE

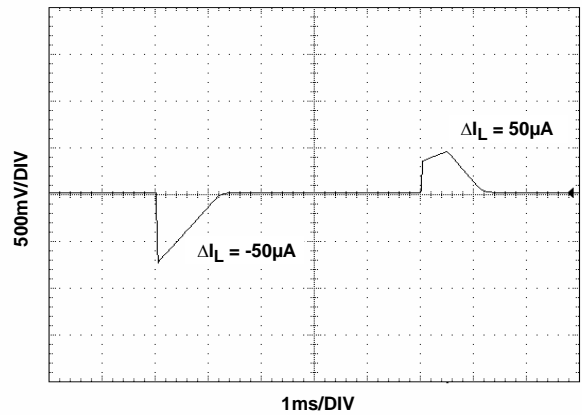

FIGURE 51. LOAD TRANSIENT RESPONSE

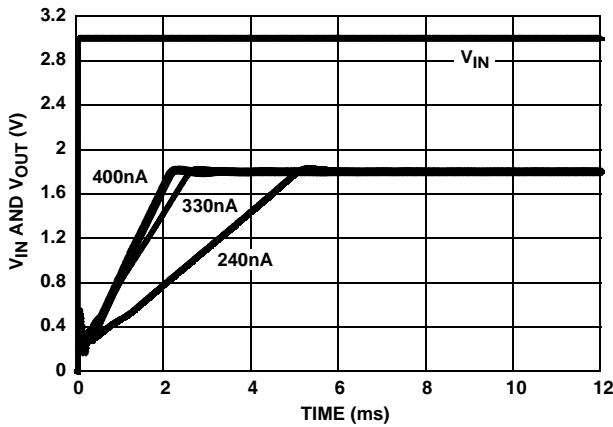

FIGURE 52. TURN-ON TIME (+25°C)

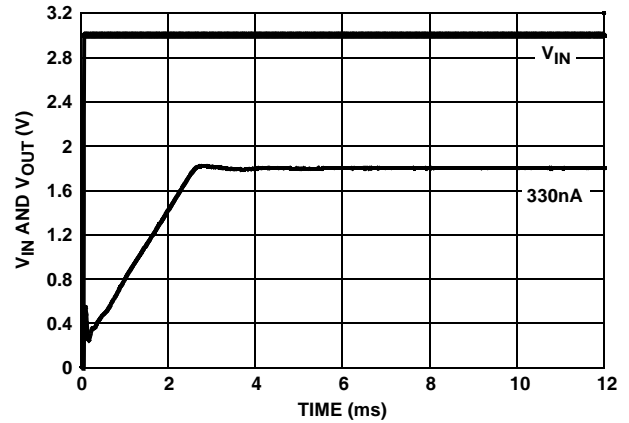

FIGURE 53. TURN-ON TIME (+25°C)

**Typical Performance Curves ISL60002,  $V_{OUT} = 1.8V$**  (Continued)

$V_{IN} = 3.0V$ ,  $I_{OUT} = 0mA$ ,  $T_A = +25^{\circ}C$  unless otherwise specified

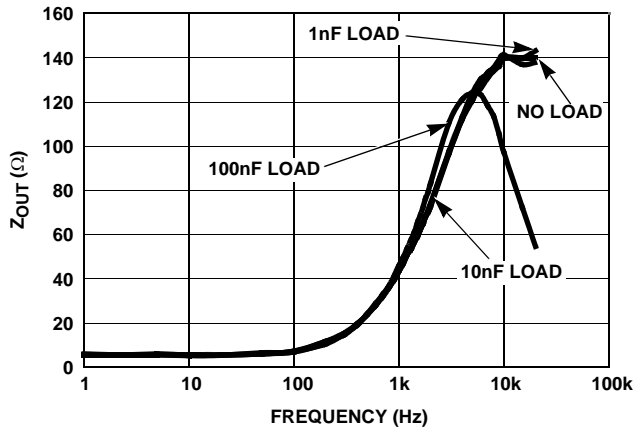

FIGURE 54.  $Z_{OUT}$  vs FREQUENCY

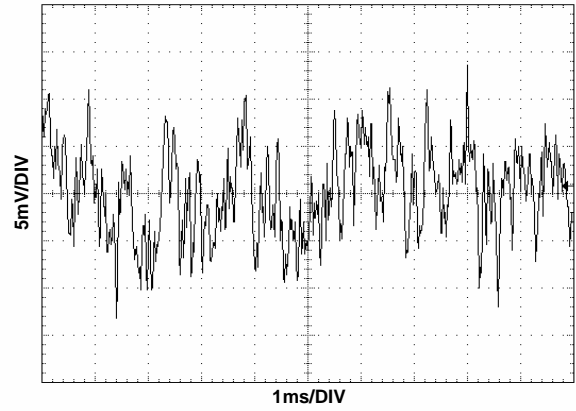

FIGURE 55.  $V_{OUT}$  NOISE

**Typical Performance Curves ISL60002,  $V_{OUT} = 2.048V$**

$V_{IN} = 3.0V$ ,  $I_{OUT} = 0mA$ ,  $T_A = +25^\circ C$  unless otherwise specified

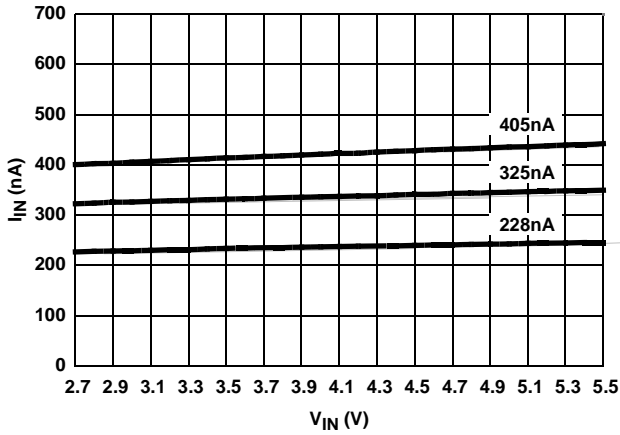

FIGURE 56.  $I_{IN}$  vs  $V_{IN}$  (3 REPRESENTATIVE UNITS)

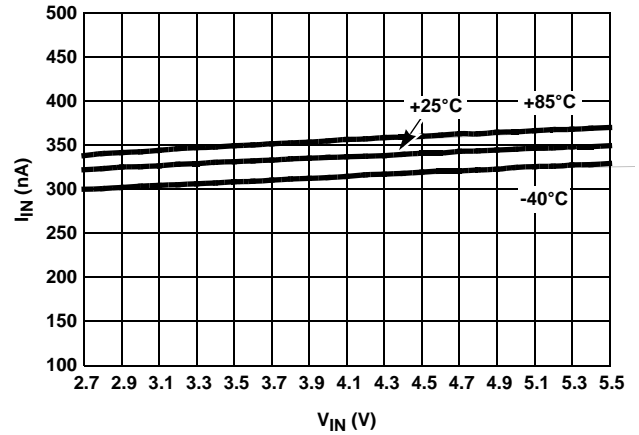

FIGURE 57.  $I_{IN}$  vs  $V_{IN}$  OVER TEMPERATURE

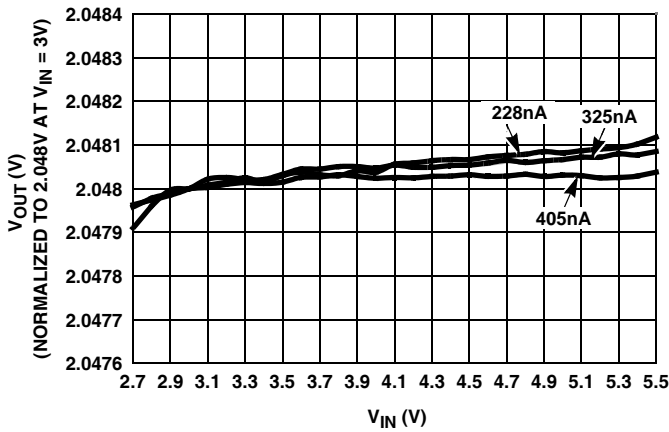

FIGURE 58. LINE REGULATION (3 REPRESENTATIVE UNITS)

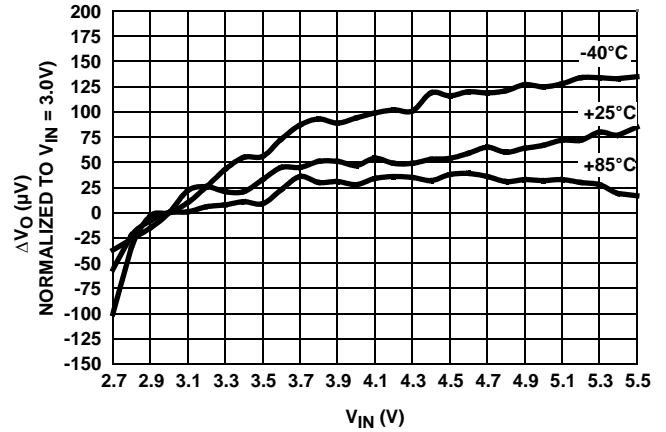

FIGURE 59. LINE REGULATION OVER TEMPERATURE

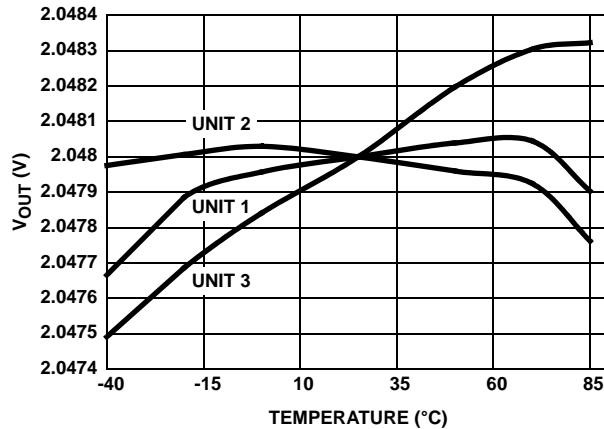

FIGURE 60.  $V_{OUT}$  vs TEMPERATURE NORMALIZED TO  $+25^\circ C$

Typical Performance Curves ISL60002,  $V_{OUT} = 2.048V$  (Continued)

$V_{IN} = 3.0V$ ,  $I_{OUT} = 0mA$ ,  $T_A = +25^{\circ}C$  unless otherwise specified

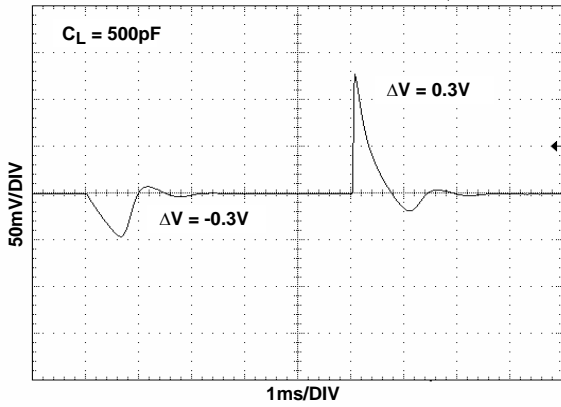

FIGURE 61. LINE TRANSIENT RESPONSE

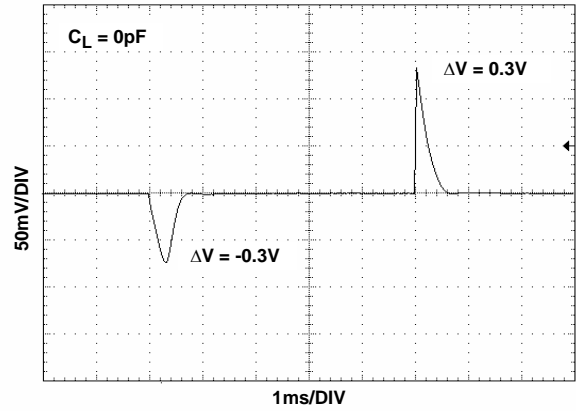

FIGURE 62. NO LOAD LINE TRANSIENT RESPONSE

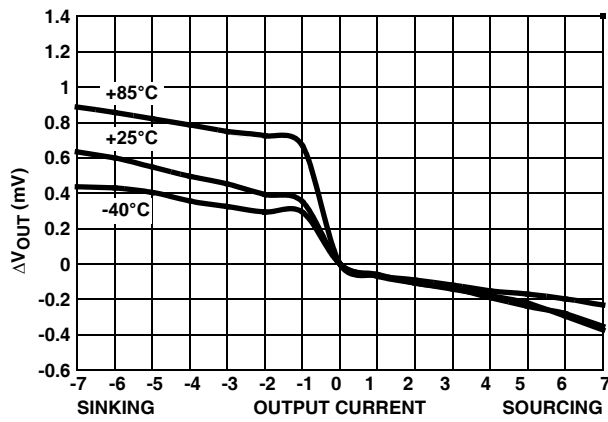

FIGURE 63. LOAD REGULATION

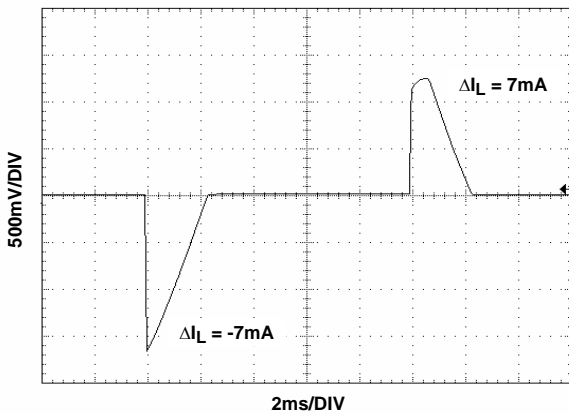

FIGURE 64. LOAD TRANSIENT RESPONSE

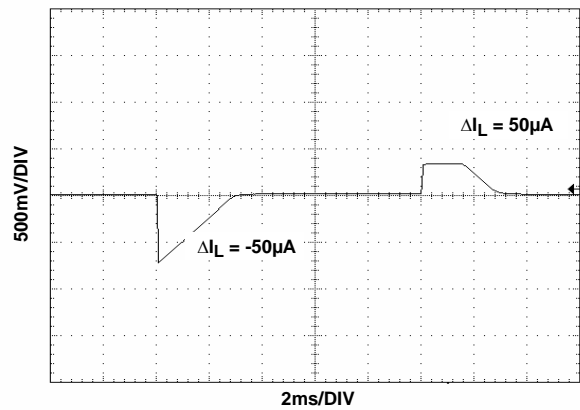

FIGURE 65. LOAD TRANSIENT RESPONSE

**Typical Performance Curves ISL60002,  $V_{OUT} = 2.048V$**  (Continued)

$V_{IN} = 3.0V$ ,  $I_{OUT} = 0mA$ ,  $T_A = +25^{\circ}C$  unless otherwise specified

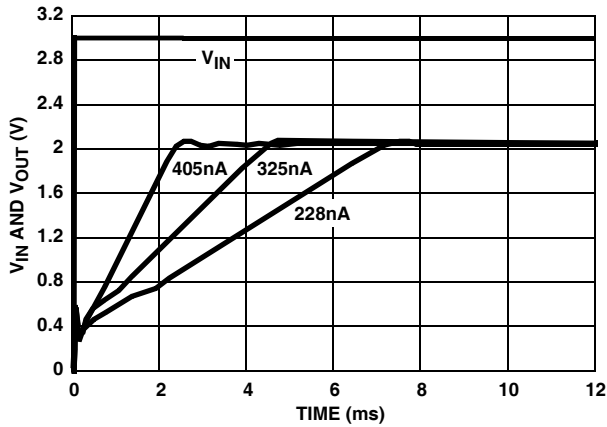

FIGURE 66. TURN-ON TIME (+25°C)

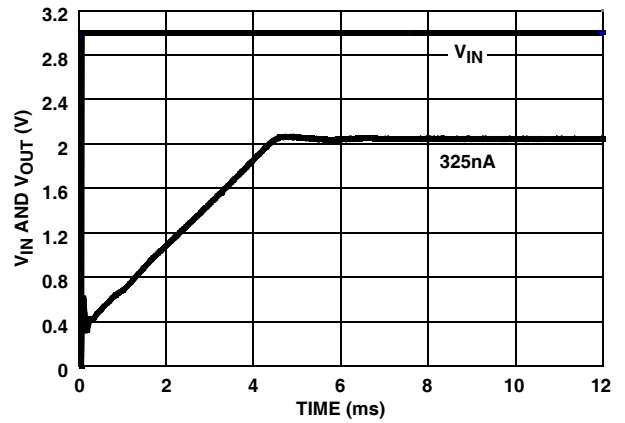

FIGURE 67. TURN-ON TIME (+25°C)

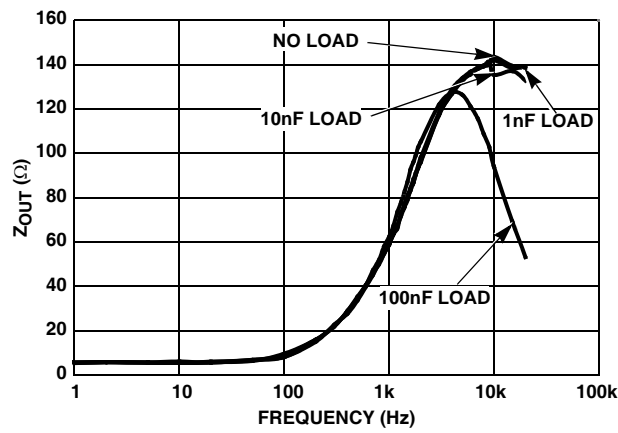

FIGURE 68.  $Z_{OUT}$  vs FREQUENCY

**Typical Performance Characteristic Curves ISL60002,  $V_{OUT} = 2.50V$**

$V_{IN} = 3.0V$ ,  $I_{OUT} = 0mA$ ,  $T_A = +25^{\circ}C$  unless otherwise specified

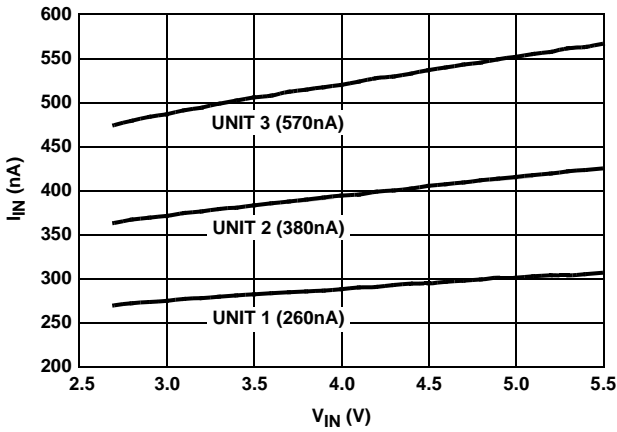

FIGURE 69.  $I_{IN}$  vs  $V_{IN}$  (3 REPRESENTATIVE UNITS)

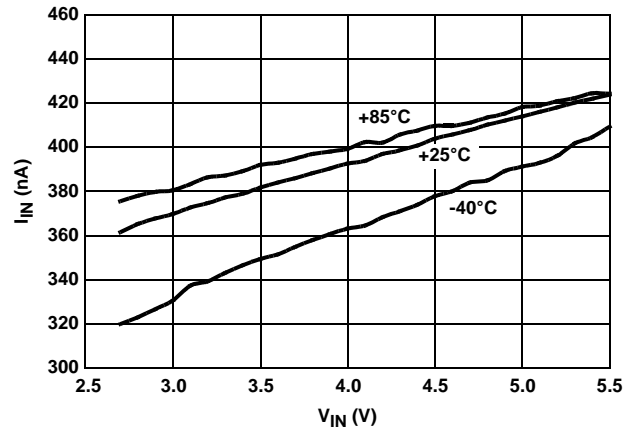

FIGURE 70.  $I_{IN}$  vs  $V_{IN}$  OVER TEMPERATURE

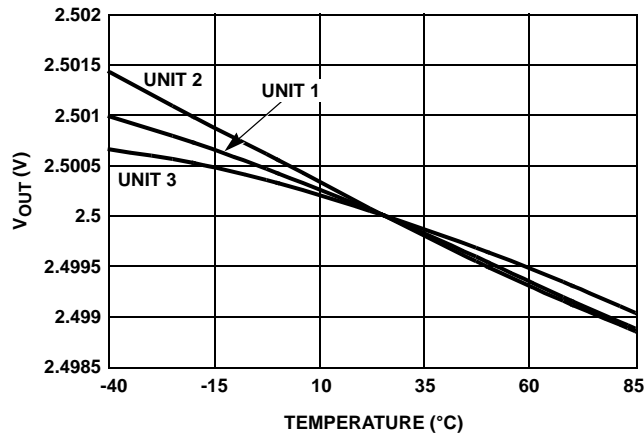

FIGURE 71.  $V_{OUT}$  vs TEMPERATURE NORMALIZED TO  $+25^{\circ}C$

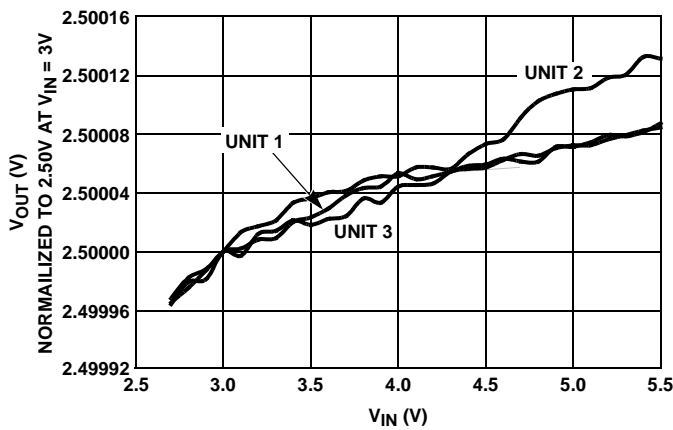

FIGURE 72. LINE REGULATION (3 REPRESENTATIVE UNITS)

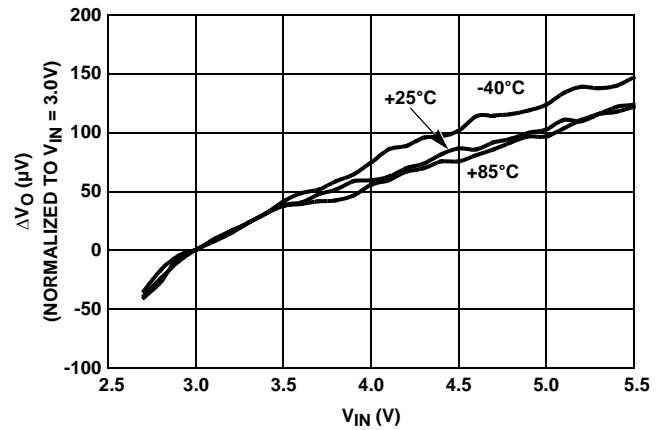

FIGURE 73. LINE REGULATION OVER TEMPERATURE

**Typical Performance Characteristic Curves ISL60002,  $V_{OUT} = 2.50V$**  (Continued)

$V_{IN} = 3.0V$ ,  $I_{OUT} = 0mA$ ,  $T_A = +25^{\circ}C$  unless otherwise specified

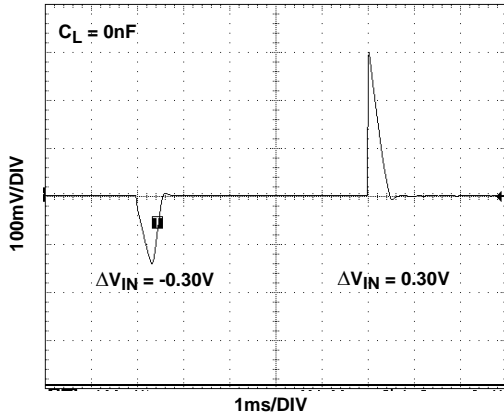

FIGURE 74. LINE TRANSIENT RESPONSE

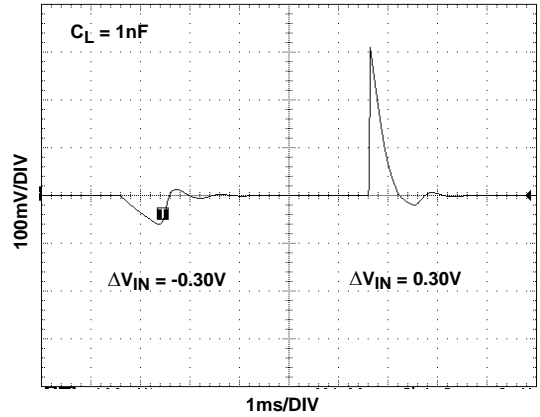

FIGURE 75. LINE TRANSIENT RESPONSE

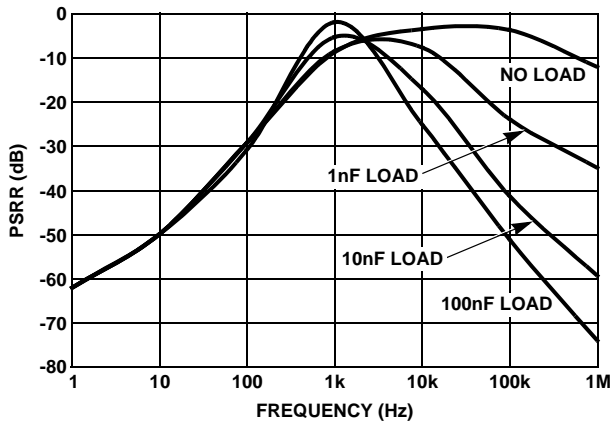

FIGURE 76. PSRR vs CAPACITIVE LOAD

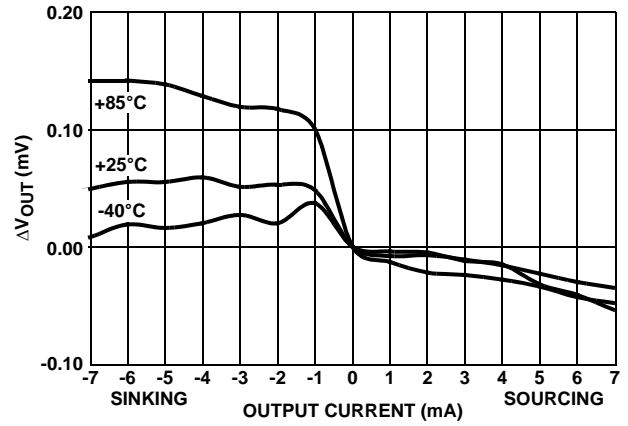

FIGURE 77. LOAD REGULATION

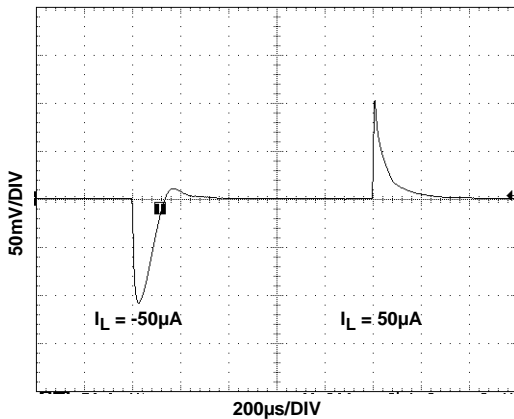

FIGURE 78. LOAD TRANSIENT RESPONSE

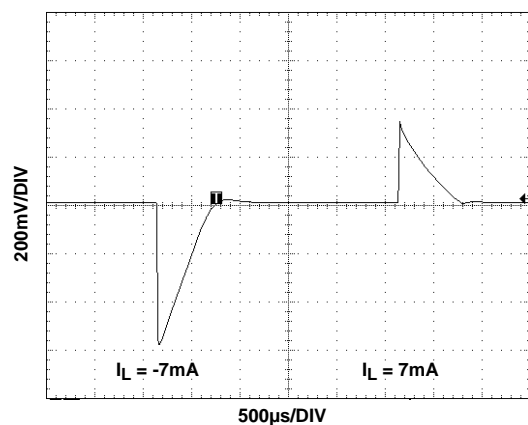

FIGURE 79. LOAD TRANSIENT RESPONSE

**Typical Performance Characteristic Curves ISL60002,  $V_{OUT} = 2.50V$  (Continued)**

$V_{IN} = 3.0V$ ,  $I_{OUT} = 0mA$ ,  $T_A = +25^{\circ}C$  unless otherwise specified

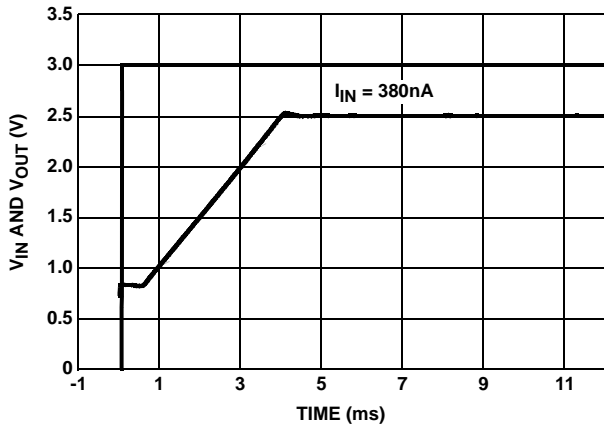

FIGURE 80. TURN-ON TIME (+25°C)

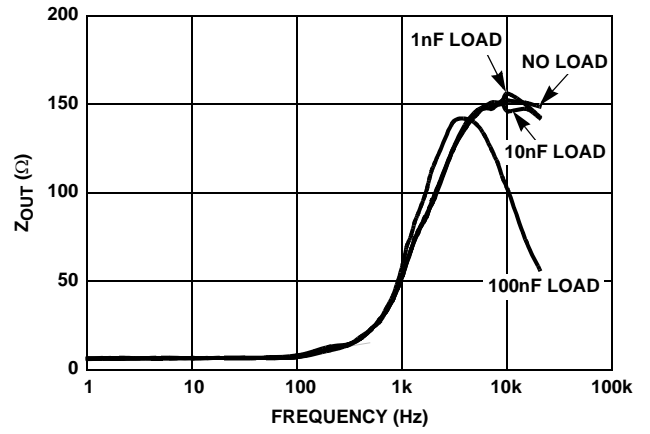

FIGURE 81.  $Z_{OUT}$  vs FREQUENCY

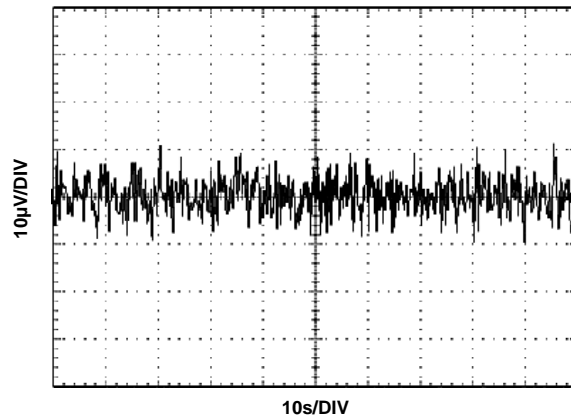

FIGURE 82.  $V_{OUT}$  NOISE



**Typical Performance Characteristic Curves ISL60002,  $V_{OUT} = 3.3V$**

$V_{IN} = 3.0V$ ,  $I_{OUT} = 0mA$ ,  $T_A = +25^{\circ}C$  unless otherwise specified

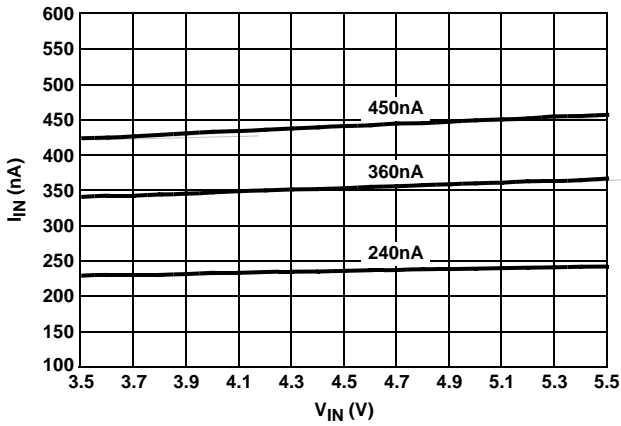

FIGURE 83.  $I_{IN}$  vs  $V_{IN}$  (3 REPRESENTATIVE UNITS)

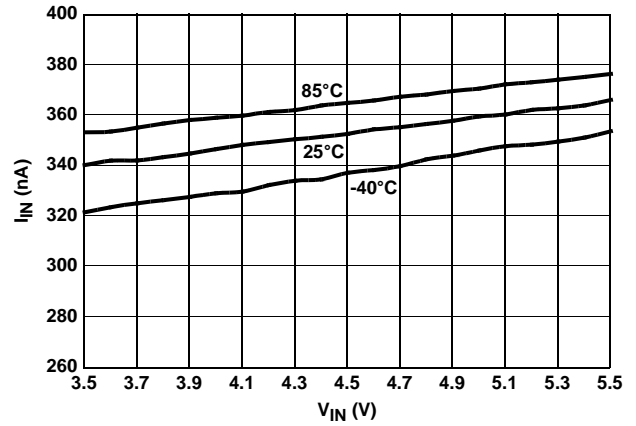

FIGURE 84.  $I_{IN}$  vs  $V_{IN}$  OVER TEMPERATURE

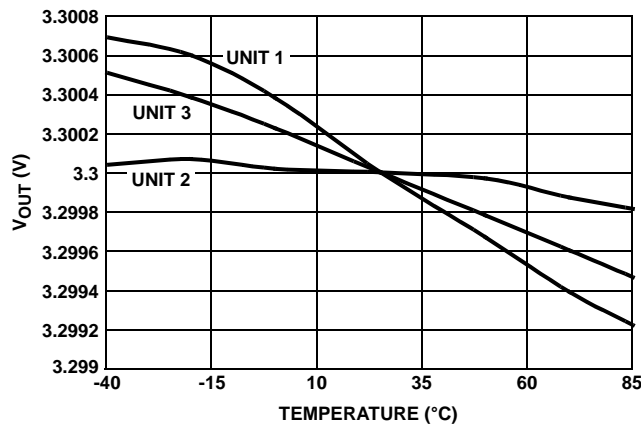

FIGURE 85.  $V_{OUT}$  vs TEMPERATURE NORMALIZED TO  $+25^{\circ}C$

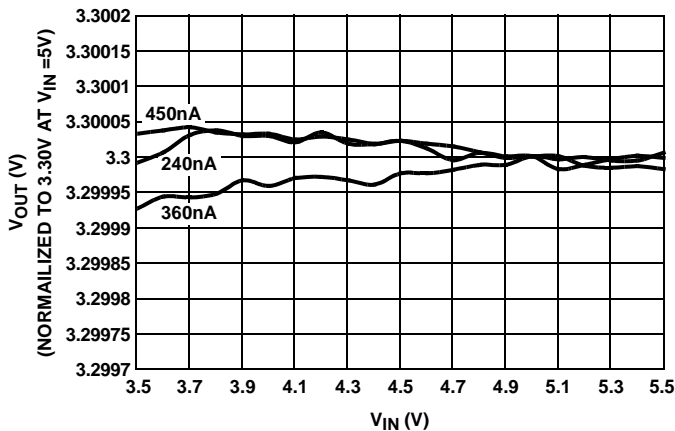

FIGURE 86. LINE REGULATION (3 REPRESENTATIVE UNITS)

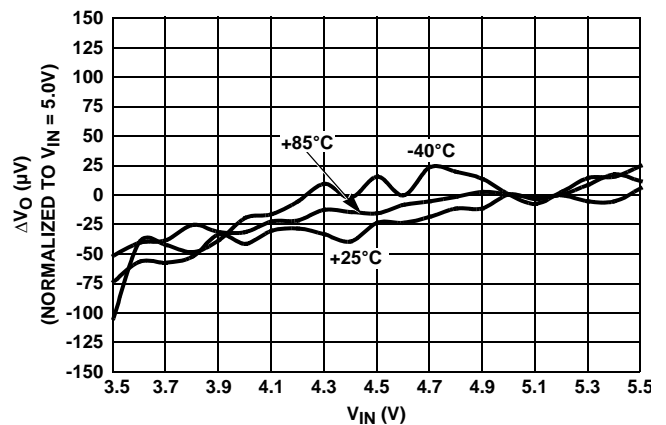

FIGURE 87. LINE REGULATION OVER TEMPERATURE

**Typical Performance Characteristic Curves ISL60002,  $V_{OUT} = 3.3V$  (Continued)**

$V_{IN} = 3.0V$ ,  $I_{OUT} = 0mA$ ,  $T_A = +25^\circ C$  unless otherwise specified

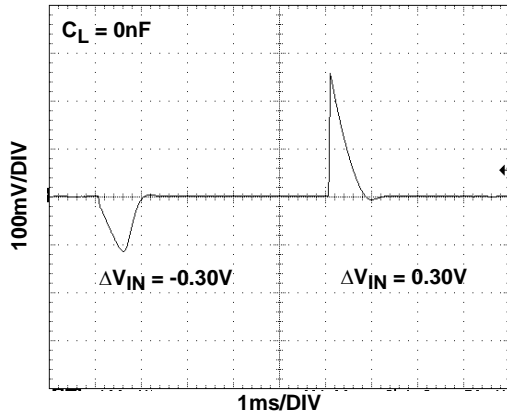

FIGURE 88. LINE TRANSIENT RESPONSE

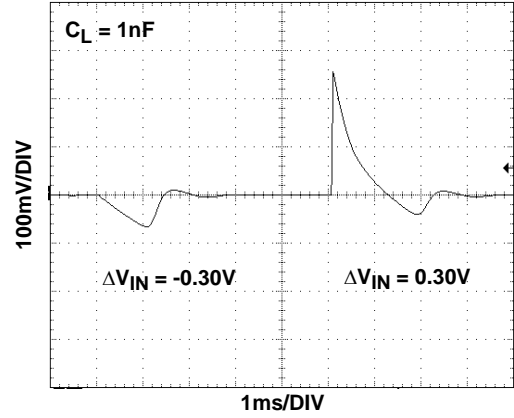

FIGURE 89. LINE TRANSIENT RESPONSE

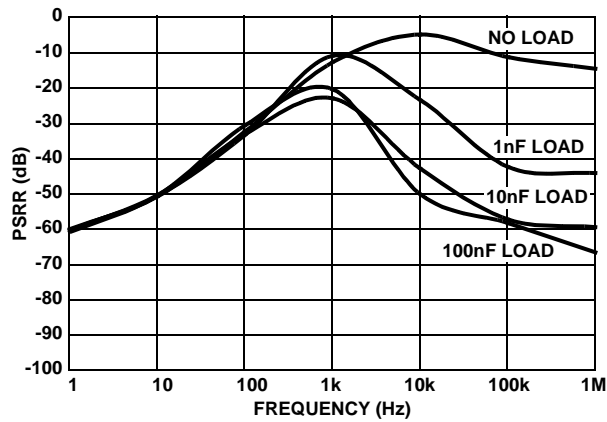

FIGURE 90. PSRR vs CAPACITIVE LOAD

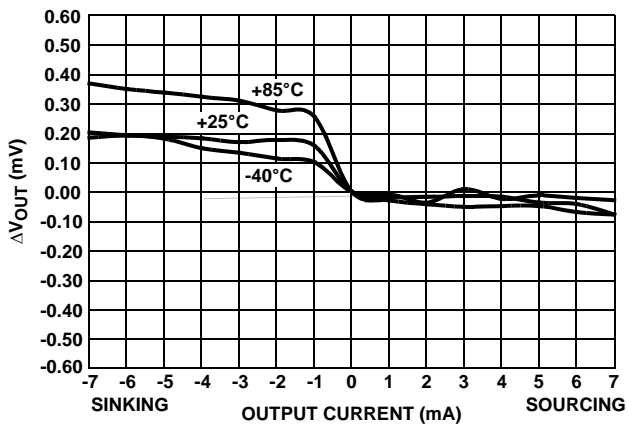

FIGURE 91. LOAD REGULATION  $I_{SOURCE} - I_{SINK} = \pm 7mA$

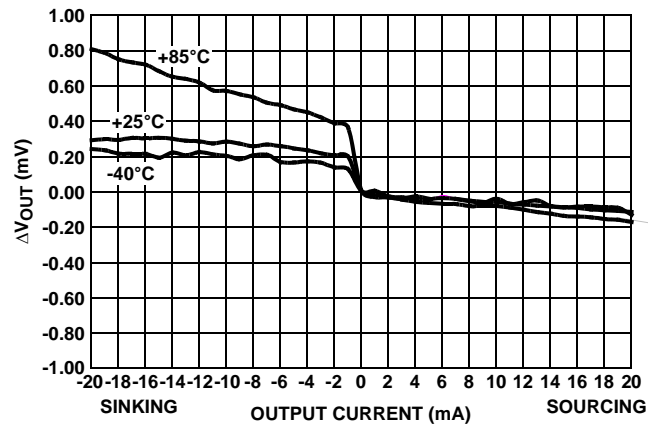

FIGURE 92. LOAD REGULATION  $I_{SOURCE} - I_{SINK} = \pm 20mA$

**Typical Performance Characteristic Curves ISL60002,  $V_{OUT} = 3.3V$**  (Continued)

$V_{IN} = 3.0V$ ,  $I_{OUT} = 0mA$ ,  $T_A = +25^\circ C$  unless otherwise specified

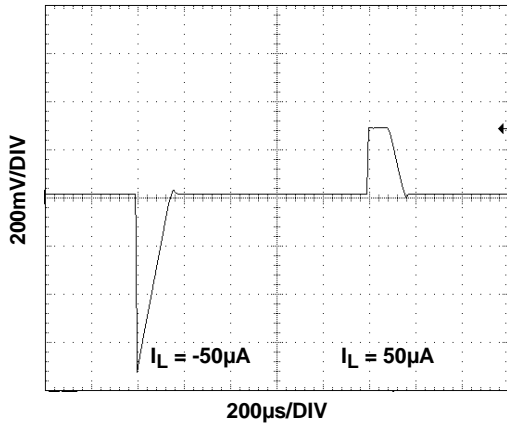

FIGURE 93. LOAD TRANSIENT RESPONSE

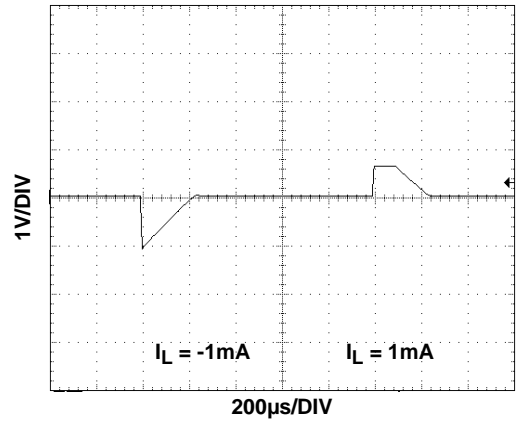

FIGURE 94. LOAD TRANSIENT RESPONSE

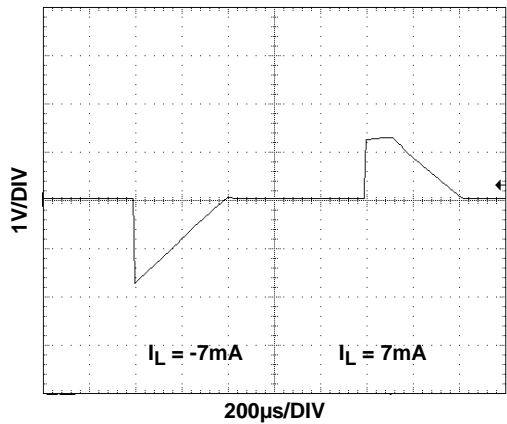

FIGURE 95. LOAD TRANSIENT RESPONSE

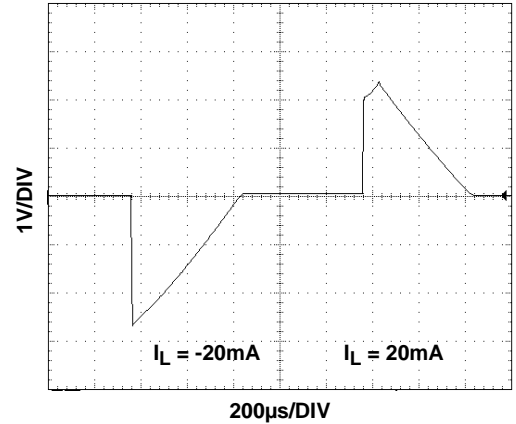

FIGURE 96. LOAD TRANSIENT RESPONSE

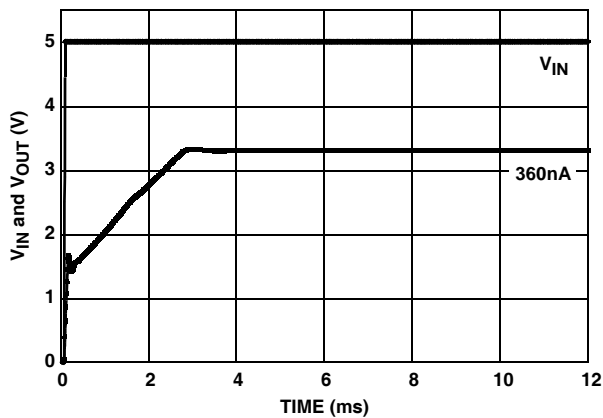

FIGURE 97. TURN-ON TIME (+25°C)

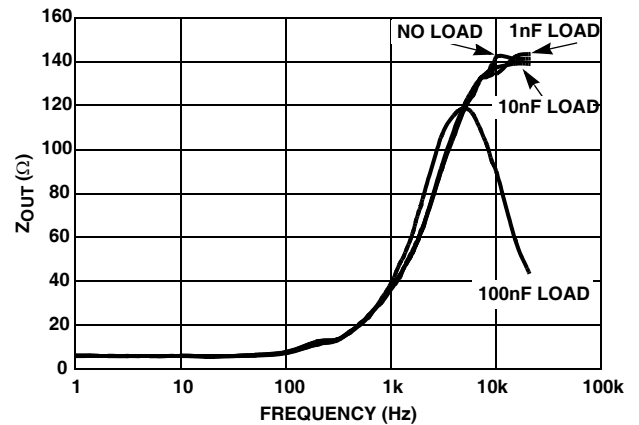

FIGURE 98.  $Z_{OUT}$  vs FREQUENCY

## Applications Information

### FGA Technology

The ISL60002 series of voltage references use the floating gate technology to create references with very low drift and supply current. Essentially the charge stored on a floating gate cell is set precisely in manufacturing. The reference voltage output itself is a buffered version of the floating gate voltage. The resulting reference device has excellent characteristics which are unique in the industry: very low temperature drift, high initial accuracy, and almost zero supply current. Also, the reference voltage itself is not limited by voltage bandgaps or zener settings, so a wide range of reference voltages can be programmed (standard voltage settings are provided, but customer-specific voltages are available).

The process used for these reference devices is a floating gate CMOS process, and the amplifier circuitry uses CMOS transistors for amplifier and output transistor circuitry. While providing excellent accuracy, there are limitations in output noise level and load regulation due to the MOS device characteristics. These limitations are addressed with circuit techniques discussed in other sections.

### Nanopower Operation

Reference devices achieve their highest accuracy when powered up continuously, and after initial stabilization has taken place. This drift can be eliminated by leaving the power on continuously.

The ISL60002 is the first high precision voltage reference with ultra low power consumption that makes it possible to leave power on continuously in battery operated circuits. The ISL60002 consumes extremely low supply current due to the proprietary FGA technology. Supply current at room temperature is typically 350nA which is 1 to 2 orders of magnitude lower than competitive devices. Application circuits using battery power will benefit greatly from having an accurate, stable reference which essentially presents no load to the battery.

In particular, battery powered data converter circuits that would normally require the entire circuit to be disabled when not in use can remain powered up between conversions as shown in Figure 99. Data acquisition circuits providing 12 to 24 bits of accuracy can operate with the reference device continuously biased with no power penalty, providing the highest accuracy and lowest possible long term drift.

Other reference devices consuming higher supply currents will need to be disabled in between conversions to conserve battery capacity. Absolute accuracy will suffer as the device is biased and requires time to settle to its final value, or, may not actually settle to a final value as power on time may be short.

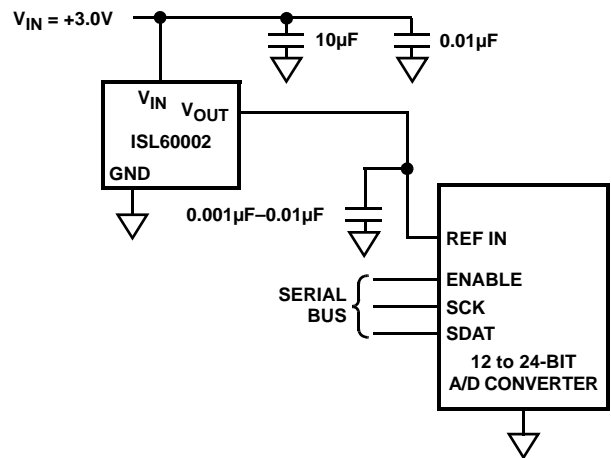

FIGURE 99.

### Board Mounting Considerations

For applications requiring the highest accuracy, board mounting location should be reviewed. Placing the device in areas subject to slight twisting can cause degradation of the accuracy of the reference voltage due to die stresses. It is normally best to place the device near the edge of a board, or the shortest side, as the axis of bending is most limited at that location. Obviously mounting the device on flexprint or extremely thin PC material will likewise cause loss of reference accuracy.

### Noise Performance and Reduction

The output noise voltage in a 0.1Hz to 10Hz bandwidth is typically  $30\mu\text{V}_{\text{P-P}}$ . This is shown in the plot in the Typical Performance Curves. The noise measurement is made with a bandpass filter made of a 1 pole high-pass filter with a corner frequency at 0.1Hz and a 2-pole low-pass filter with a corner frequency at 12.6Hz to create a filter with a 9.9Hz bandwidth. Noise in the 10kHz to 1MHz bandwidth is approximately  $400\mu\text{V}_{\text{P-P}}$  with no capacitance on the output, as shown in Figure 100. These noise measurements are made with a 2 decade bandpass filter made of a 1 pole high-pass filter with a corner frequency at 1/10 of the center frequency and 1-pole low-pass filter with a corner frequency at 10 times the center frequency. Figure 100 also shows the noise in the 10kHz to 1MHz band can be reduced to about  $50\mu\text{V}_{\text{P-P}}$  using a  $0.001\mu\text{F}$  capacitor on the output. Noise in the 1kHz to 100kHz band can be further reduced using a  $0.1\mu\text{F}$  capacitor on the output, but noise in the 1Hz to 100Hz band increases due to instability of the very low power amplifier with a  $0.1\mu\text{F}$  capacitance load. For load capacitances above  $0.001\mu\text{F}$  the noise reduction network shown in Figure 101 is recommended. This network reduces noise significantly over the full bandwidth. As shown in Figure 100, noise is reduced to less than  $40\mu\text{V}_{\text{P-P}}$  from 1Hz to 1MHz using this network with a  $0.01\mu\text{F}$  capacitor and a  $2\text{k}\Omega$  resistor in series with a  $10\mu\text{F}$  capacitor.

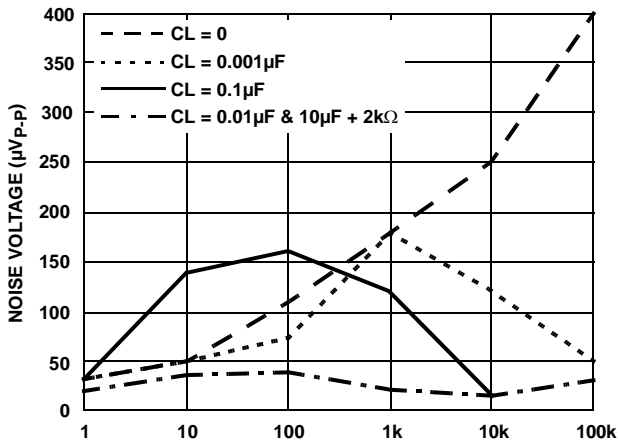

FIGURE 100. NOISE REDUCTION

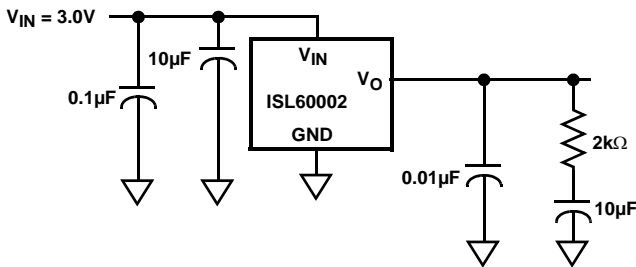
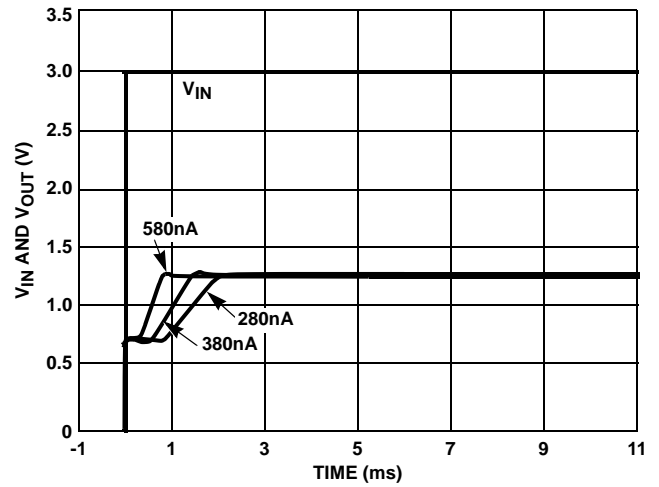

FIGURE 101.

**Turn-On Time**

The ISL60002 devices have ultra-low supply current and thus the time to bias up internal circuitry to final values will be longer than with higher power references. Normal turn-on time is typically 7ms. This is shown in Figure 102. Since devices can vary in supply current down to >300nA, turn-on time can last up to about 12ms. Care should be taken in system design to include this delay before measurements or conversions are started.

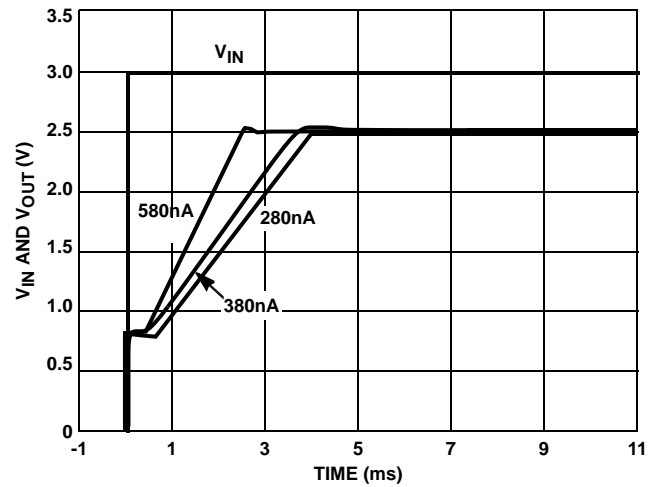

FIGURE 102. TURN-ON TIME

**Temperature Coefficient**

The limits stated for temperature coefficient (tempco) are governed by the method of measurement. The overwhelming standard for specifying the temperature drift of a reference is to measure the reference voltage at two temperatures, take the total variation, ( $V_{HIGH} - V_{LOW}$ ), and divide by the temperature extremes of measurement ( $T_{HIGH} - T_{LOW}$ ). The result is divided by the nominal reference voltage (at  $T = 25^{\circ}C$ ) and multiplied by  $10^6$  to yield ppm/ $^{\circ}C$ . This is the "Box" method for specifying temperature coefficient.

Typical Application Circuits

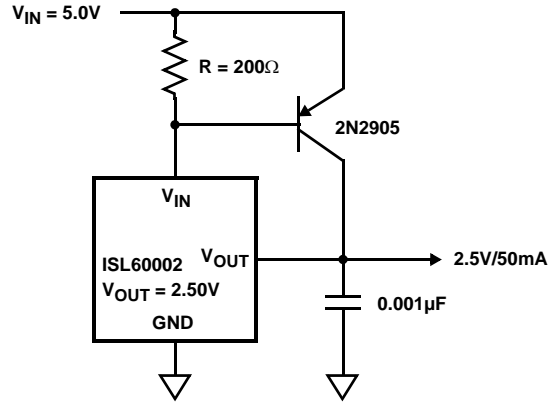

FIGURE 103. PRECISION 2.5V 50mA REFERENCE

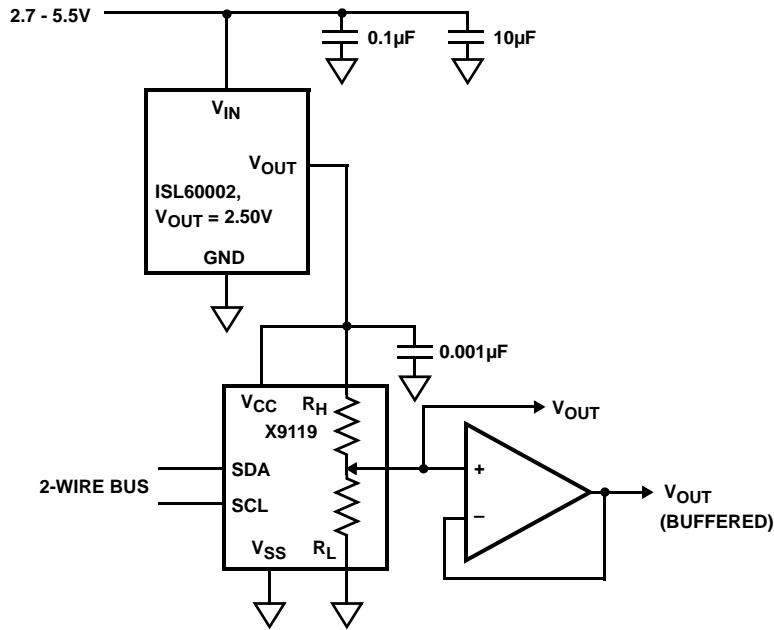

FIGURE 104. 2.5V FULL SCALE LOW-DRIFT 10-BIT ADJUSTABLE VOLTAGE SOURCE

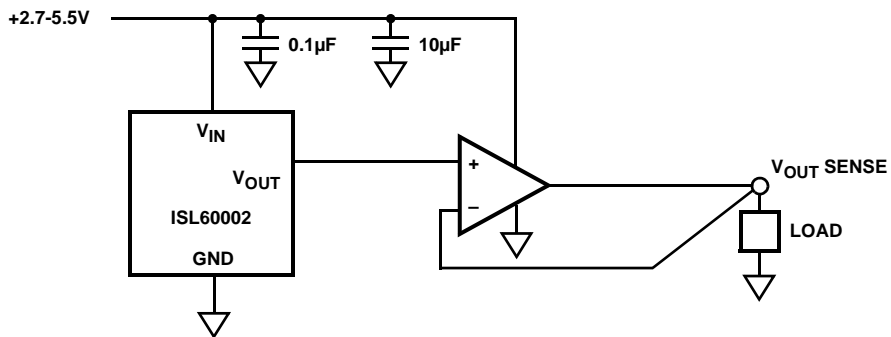
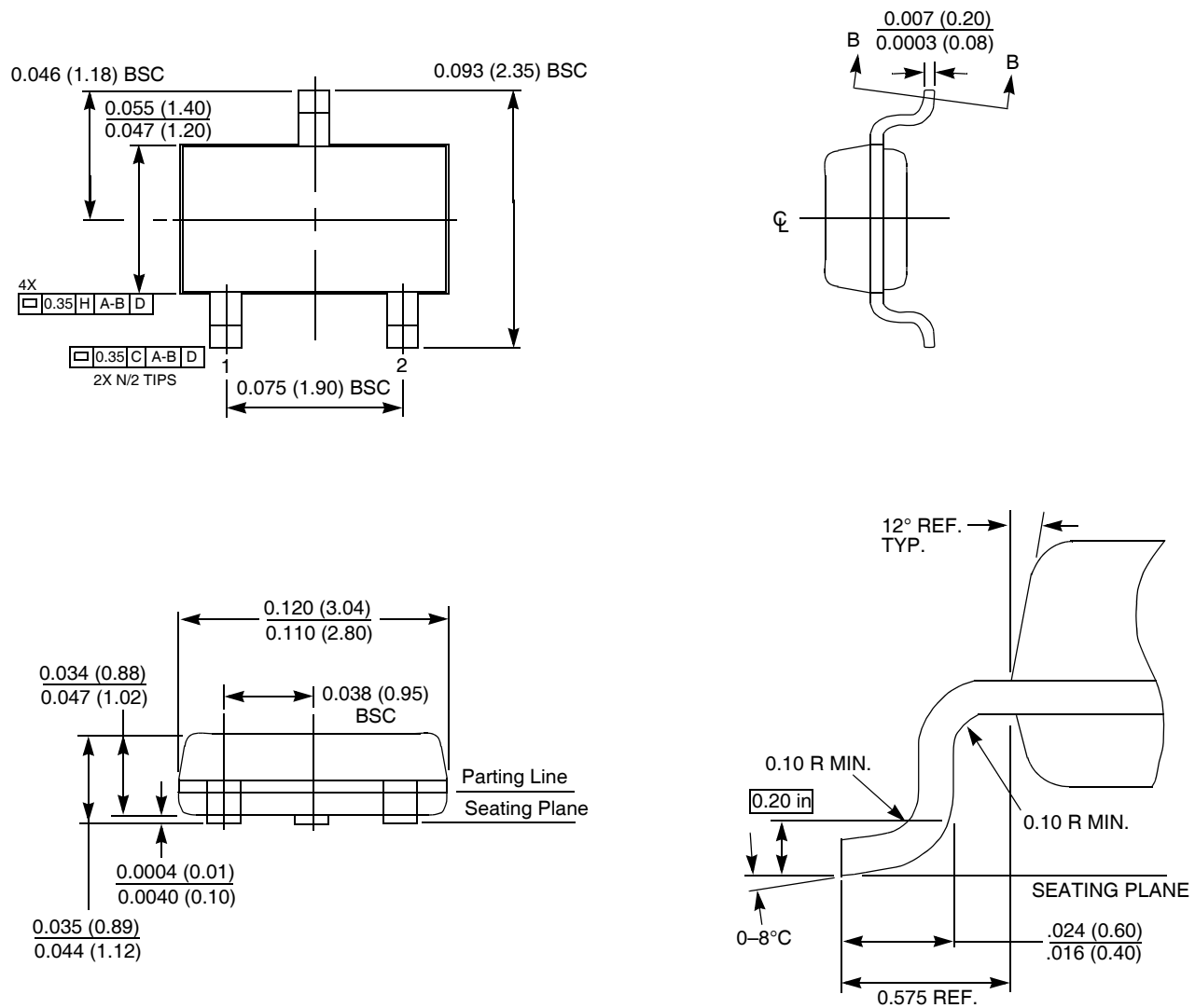

FIGURE 105. KELVIN SENSED LOAD

## Packaging Information

## 3-Lead, SOT-23, Package Code H3



## NOTES:

1. All dimensions in inches (in parentheses in millimeters).
2. Package dimensions exclude molding flash.
3. Die and die paddle is facing down towards seating plane.
4. This part is compliant with JEDEC Specification TO-236AB.
5. Dimensioning and tolerances per ASME, Y14.5M-1994.

All Intersil U.S. products are manufactured, assembled and tested utilizing ISO9000 quality systems.

Intersil Corporation's quality certifications can be viewed at [www.intersil.com/design/quality](http://www.intersil.com/design/quality)

Intersil products are sold by description only. Intersil Corporation reserves the right to make changes in circuit design, software and/or specifications at any time without notice. Accordingly, the reader is cautioned to verify that data sheets are current before placing orders. Information furnished by Intersil is believed to be accurate and reliable. However, no responsibility is assumed by Intersil or its subsidiaries for its use; nor for any infringements of patents or other rights of third parties which may result from its use. No license is granted by implication or otherwise under any patent or patent rights of Intersil or its subsidiaries.

For information regarding Intersil Corporation and its products, see [www.intersil.com](http://www.intersil.com)