

基板取付穴推奨寸法 (マウント面)
RECOMMENDED P.C. BOARD HOLE DIMENSION (t=1.6)
(MOUNTING SIDE) (SCALE 5:1)

注記 NOTES

- ① 偶数極品に適用。
APPLIES ONLY TO EVEN NO. CKT. SIZES.
- 2. 嵌合相手: 51102, 51103 シリーズ
MATES WITH: 51102, 51103 SERIES.
- ③ 累積ピッチの許容差は、20ピッチで ±1.0mm とする。
ACCUMULATED TOLERANCE IS TO BE ±1.0mm PER 20 PITCH.
- ④ 粘着テープは台紙からはみ出さないこと。
THE ADHESIVE TAPE SHOULD NOT BE PROTRUDED FROM THE BASE TAPE.
- ⑤ リード線の曲がりの許容差は 1mm MAX. とする。
CAMBER OF THE LEADS: 1mm MAX.
- ⑥ 測定位置は、コネクタの先端とする。
INCLINED POSITION FROM THE CENTER-LINE, SHOULD BE 1mm MAX. MEASURING SHOULD BE DONE, USING THE TOP OF BASE TAPE AS DATUM.
- ⑦ 測定位置は、台紙の上端とし、リード線の中心線との間隔とする。
DIM. 3.85 AND DIM. 5 SHOULD BE MEASURED ON THE TOP OF BASE TAPE. DIMENSIONS ARE A SPACING BETWEEN THE CENTER-LINES.

400	9.95	25.4	22.4	20.7	17.5	53375-0890	8
	7.45	↑	19.9	18.2	15	↑	-0790
500	7.45	↓	17.4	15.7	12.5	↓	-0690
	4.95	↓	14.9	13.2	10	↓	-0590
900	4.95	↓	12.4	10.7	7.5	↓	-0490
	2.45	↓	9.9	8.2	5	↓	-0390
	2.45	↓	7.4	5.7	2.5	↓	-0290
包装数量/箱 QTY./CARTON	E	D	C	B	A	MATERIAL NO.	極数 NO. OF CKTS.

材料 MATERIAL		図中参照 SEE DRAWING		MOLLEX MOLEX-JAPAN CO., LTD. 日本モレックス株式会社	
E 変更 REVISD	(J2004-3573)	Y.W	M.S	04/04/05	仕上げ FINISH —
D 変更 REVISD	(J30223)	K.T	H.H	'93/3/10	
C 変更 REVISD	(J3021)	K.T	H.H	'93/2/9	適用電線範囲 WIRE RANGE —
B 変更 REVISD	(J30000)	H.H	M.F	'93/1/7	
A 変更 REVISD	(J20671)	K.T	H.H	'92/7/29	被覆外径 INS. RANGE —
① 新規作成 PROPOSED	(J20390)	K.T	H.H	'92/5/8	
記号 LTR	変更内容 REVISION RECORD	DR. CHK.	日付 DATE	尺貫 SCALE 3:1	DRAWN BY '92/5/6 K.TOJO
角度 ANGLE	±3°				CHK'D BY '93/3/10 H.HIRAMOTO
30° 以上 OVER	+0.3				
10° 以上 OVER 30° 未満 UNDER	+0.25				
10° 未満 UNDER	+0.2				
一般公差 GENERAL TOLERANCES					

E

D

C

B

A

DIMENSIONS IN METRIC DO NOT SCALE DRAWING

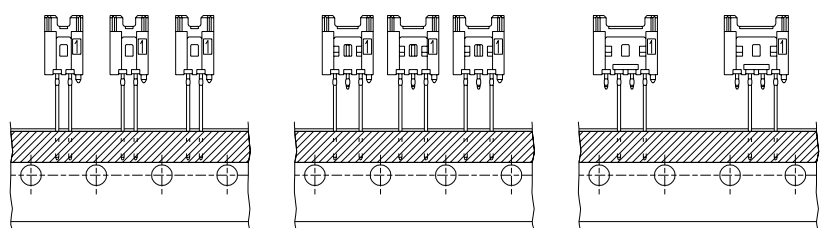

(2 極) (2 CKT.) (3 極) (3 CKT.) (4 極) (4 CKT.)

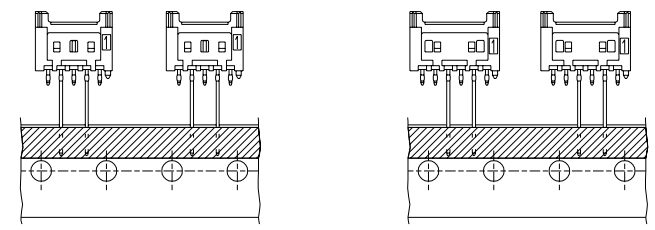

(5 極) (5 CKT.) (6 極) (6 CKT.)

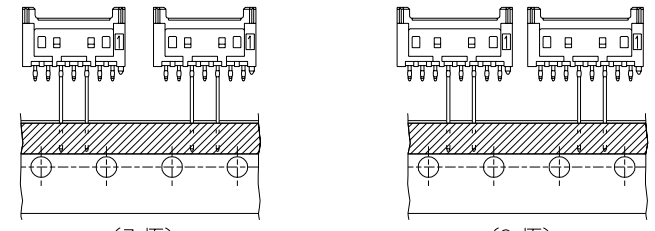

(7 極) (7 CKT.) (8 極) (8 CKT.)

極数別テーピング状態図
CKT. TAPING FORM

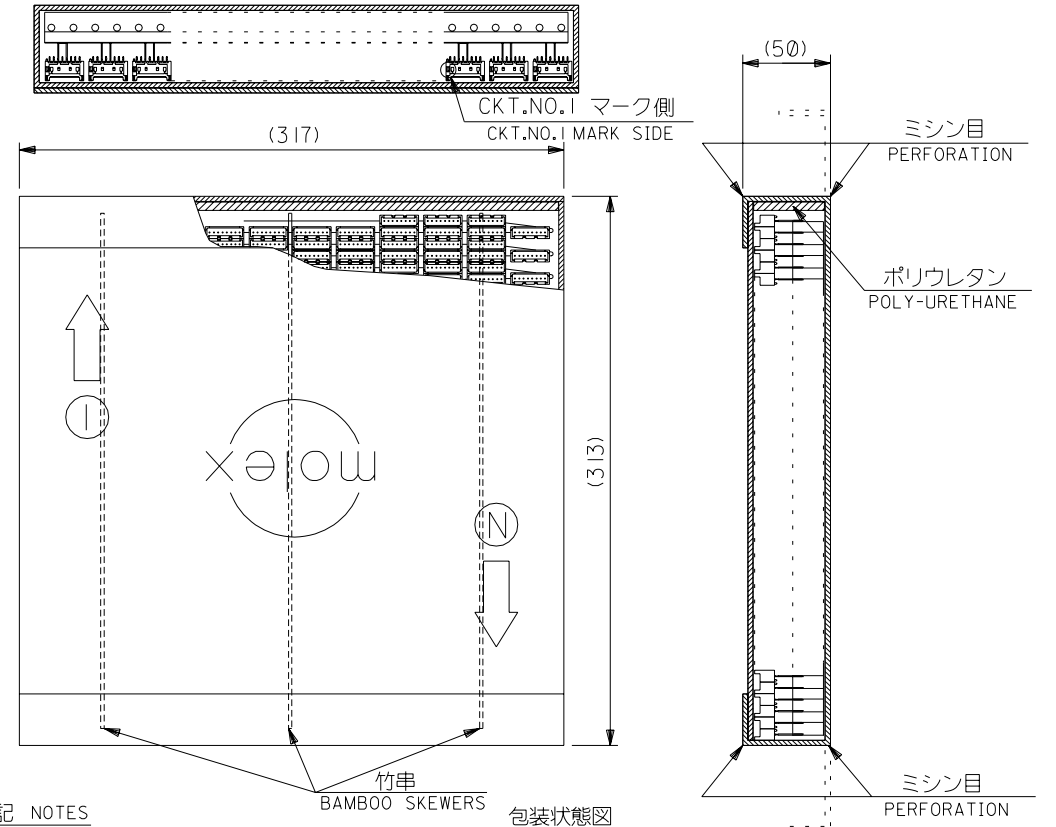
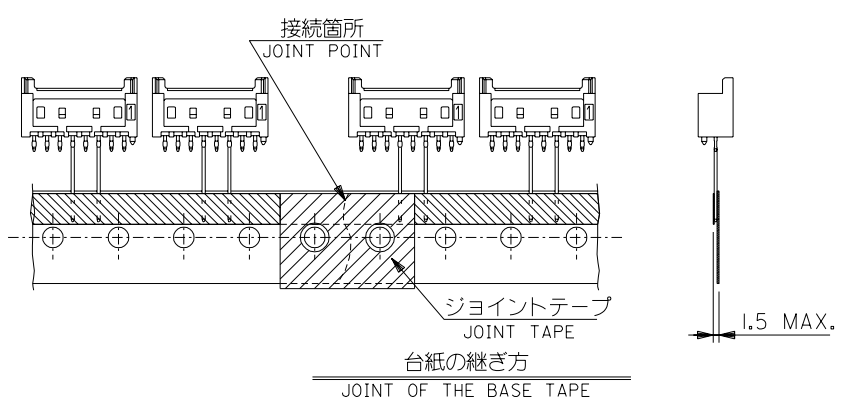

注記 NOTES

- 包装形態はつづら折りで箱詰め。
RADIAL TAPE IS FOLDED AND PILED IN THE CARTON.
- テーピングの両端には、5個以上の送り穴を設けること。
BOTH ENDS OF TAPING, MORE THAN 5 FEEDING HOLES SHOULD BE PROVIDED.
- コネクタの欠落数は、D寸法 (SHEET 1 OF 2 参照) が 12、7の場合連続3個まで、2.5、4の場合1個とする。(折り目ごとの1個抜きも含む)
ALLOWABLE NUMBERS OF CONSECUTIVE MISSING CONNECTORS:
FOR CONNECTORS WHERE D=12.7,=3(REFER TO SHEET 1 OF 2)
FOR CONNECTORS WHERE D=25.4,=1
- 台紙の継ぎ目のずれは、いかなる方向からも±0.3以内とする。
MISMATCHED JOINT OF THE BASE TAPE SHOULD BE KEPT WITHIN ±0.3mm IN EVERY DIRECTIONS.
- 図中指示以外の項目は、日本工業規格 JIS C0805 “電子部品のテーピング”を適用。
ITEMS UNLESS OTHERWISE SPECIFIED, JIS C 0805 (TAPING OF ELECTRONIC COMPONENTS) SHOULD BE APPLIED.

		材料 MATERIAL		SHEET 1 OF 2 参照		MOLEX		MOLEX-JAPAN CO.,LTD.	
		E 変更 REVISIED		Y.W		04/04/05		日本モレックス株式会社	
		D 変更 REVISIED		K.T		93/3/10		REVISE ONLY ON CAD SYSTEM	
角度 ANGLE		±3°		C 変更 REVISIED		K.T		TITLE 名称	
30°以上 OVER		+0.3		B 変更 REVISIED		M.F		2.5 WIRE TO BOARD CONN.	
10°以上 OVER 30°未下 UNDER		+0.25		A 変更 REVISIED		H.H		WAFER ASS'Y RADIAL TAPING	
未下 UNDER		+0.2		0 新規作成 PROPOSED		K.T		-LEAD FREE-	
一般公差 GENERAL TOLERANCES		記号 LTR		変更内容 REVISION RECORD		DR. CHK.		DRAWN BY '92/5/6 K.TOJO	
								CHK'D BY '93/3/10 H.HIRAMOTO	
								APP'D BY '93/3/10 M.FUKUSHIMA	
								尺度 SCALE	
								—	
								DWG. NO. (SHEET 2 OF 2) REV	
								SD-53375-**-90 E	

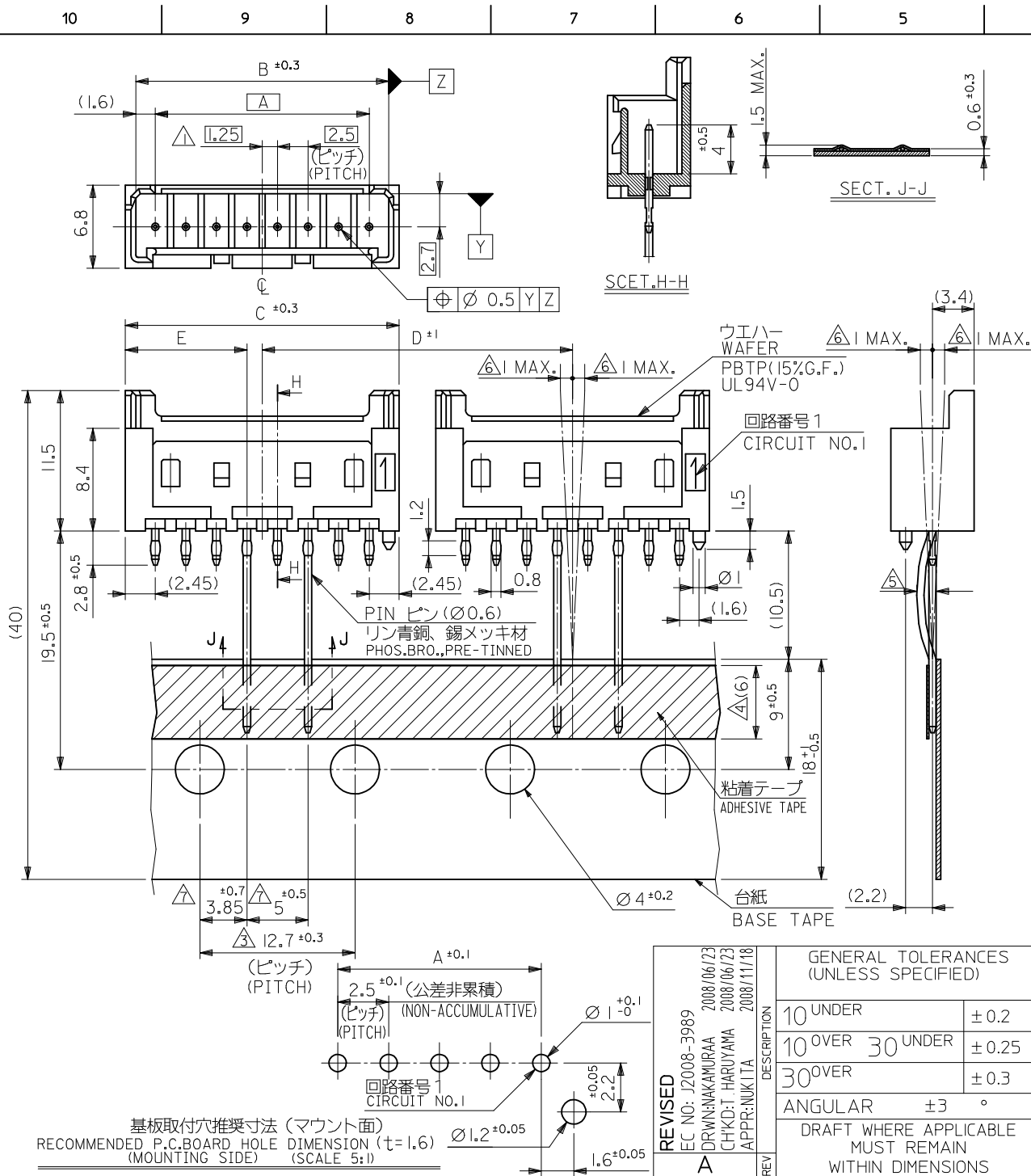

注記 NOTES

- △ 偶数極品に適用。
APPLIES ONLY TO EVEN NO. CKT. SIZES.
- 2. 嵌合相手：51103 シリーズ
MATES WITH:51103 SERIES.
- △ 累積ピッチの許容差は、20ピッチで ±1.0mm とする。
ACCUMULATED TOLERANCE IS TO BE ±1.0mm PER 20 PITCH.
- △ 粘着テープは台紙からはみ出さない事。
THE ADHESIVE TAPE SHOULD NOT BE PROTRUDED FROM THE BASE TAPE.
- △ リード線の曲がりの許容差は 1mm MAX. とする。
CAMBER OF THE LEADS : 1mm MAX.
- △ 測定位置は、コネクタの先端とする。
INCLINED POSITION FROM THE CENTER-LINE, SHOULD BE 1mm MAX.
MEASURING SHOULD BE DONE, USING THE TOP OF BASE TAPE AS DATUM.
- △ 測定値は台紙の上端とし、リード線との間隔とする。
DIM. 3.85 AND DIM. 5 SHOULD BE MEASURED ON THE TOP OF BASE TAPE. DIMENSIONS ARE A SPACING BETWEEN THE CENTER-LINES.
- 8. 製品番号の下1桁は色を表します。
LAST DIGIT OF PART NUMBER INDICATES COLOR.
0 : 白 WHITE 1 : 黒 BLACK 2 : 赤 RED
3 : 黄 YELLOW 4 : 青 BLUE

400	9.95	25.4	22.4	20.7	17.5	53375-089*	8
	7.45	↑	19.9	18.2	15	↑	-079* 7
500	7.45	↓	17.4	15.7	12.5	↑	-069* 6
	4.95	↓	14.9	13.2	10	↑	-059* 5
900	4.95	25.4	12.4	10.7	7.5	↑	-049* 4
	2.45	12.7	9.9	8.2	5	↓	-039* 3
包装数量/箱 QTY/CARTON	2.45	12.7	7.4	5.7	2.5	53375-029*	2
						MATERIAL NO.	極数 NO. OF CKT.
					MODEL NO.	53375-**-9*	

REVISED EC NO: J2008-3989 DRWN: MAKURAA 2008/06/23 CHKD: T. HARIYAMA 2008/06/23 APPR: NUKITA 2008/11/18	GENERAL TOLERANCES (UNLESS SPECIFIED)	
	10 UNDER	±0.2
	10 OVER 30 UNDER	±0.25
	30 OVER	±0.3
ANGULAR	±3 °	
DRAFT WHERE APPLICABLE MUST REMAIN WITHIN DIMENSIONS		

DIMENSION STYLE MM ONLY	SCALE 3:1	DESIGN UNITS METRIC	THIRD ANGLE PROJECTION
DRAWN BY M. UEDA	DATE 2005/01/21	TITLE 2.5 WIRE TO BOARD CONN. WAFER ASSY RADIAL TAPING -LEAD FREE-	
CHECKED BY K. TOYODA	DATE 2005/01/21	MOLEX INCORPORATED	
APPROVED BY N. UKITA	DATE 2005/01/21	MATERIAL NO. SD-53375-004	SHEET NO. 1 OF 3
THIS DRAWING CONTAINS INFORMATION THAT IS PROPRIETARY TO MOLEX INCORPORATED AND SHOULD NOT BE USED WITHOUT WRITTEN PERMISSION			

10 9 8 7 6 5 4 3 2 1

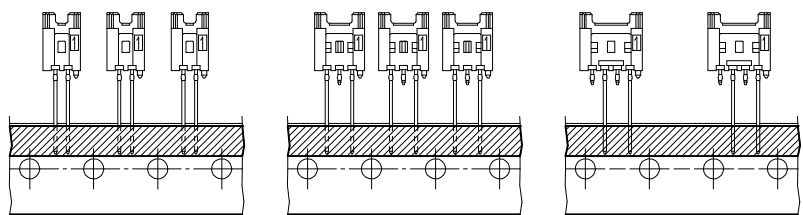

(2 極) (2 CKT.) (3 極) (3 CKT.) (4 極) (4 CKT.)

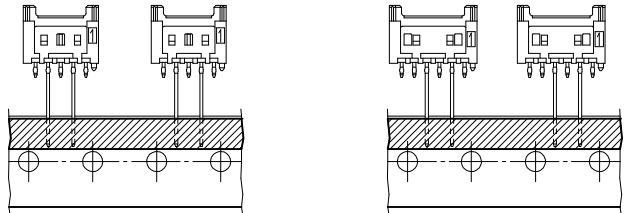

(5 極) (5 CKT.) (6 極) (6 CKT.)

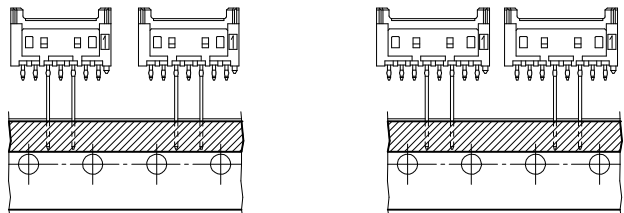

(7 極) (7 CKT.) (8 極) (8 CKT.)

極数別テーピング状態図
CKT. TAPING FORM

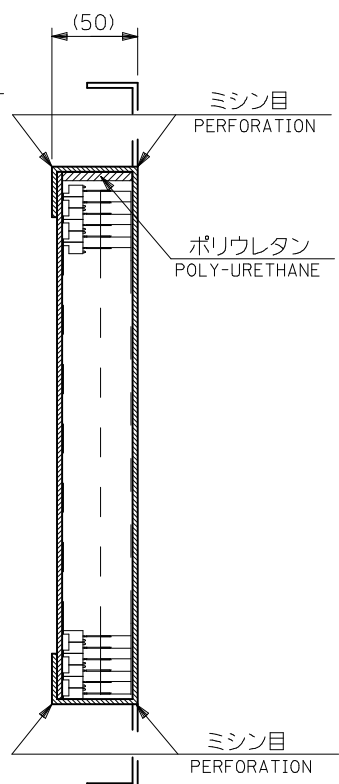
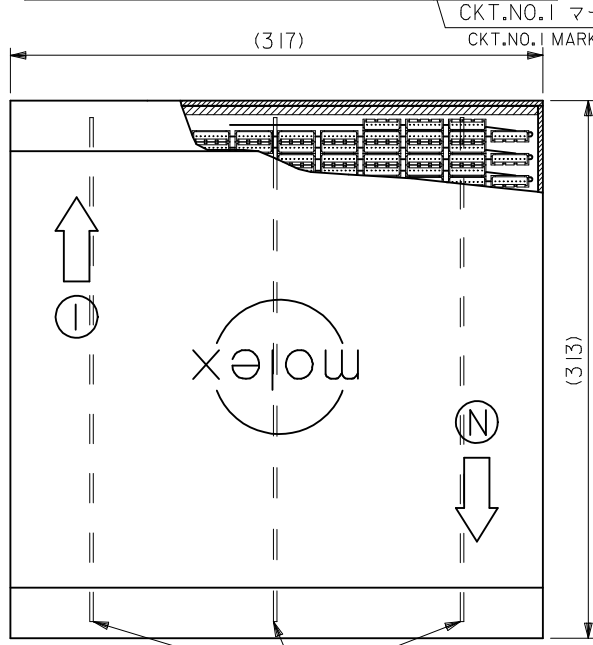
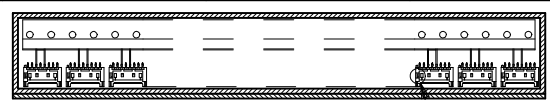
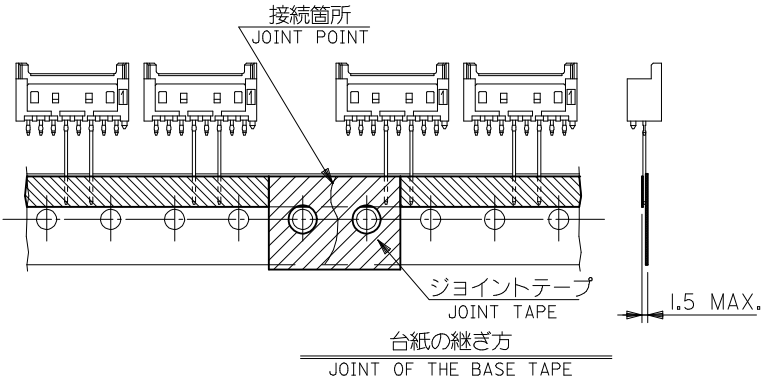

注記 NOTES

- 包装形態はつづら折りで箱詰め。
RADIAL TAPE IS FOLDED AND PILED IN THE CARTON.
- テーピングの両端には、5個以上の送り穴を設けること。
BOTH ENDS OF TAPING, MORE THAN 5 FEEDING HOLES SHOULD BE PROVIDED.
- コネクタの欠落数は、D寸法 (SHEET 1 OF 2 参照) が12、7の場合連続3個まで、25、4の場合1個とする。(折り目ごとの1個抜きも含む)
ALLOWABLE NUMBERS OF CONSECUTIVE MISSING CONNECTORS:
FOR CONNECTORS WHERE D=12.7,=3(REFER TO SHEET 1 OF 2)
FOR CONNECTORS WHERE D=25.4,=1
- 台紙の継ぎ目のずれは、いかなる方向からも ±0.3以内とする。
MISMATCHED JOINT OF THE BASE TAPE SHOULD BE KEPT WITHIN ±0.3mm IN EVERY DIRECTIONS.
- 図中以外の項目は、日本工業規格 JIS C0805 "電子部品のテーピング" を適用。
ITEMS UNLESS OTHERWISE SPECIFIED, JIS C 0805 (TAPING OF ELECTRONIC COMPONENTS) SHOULD BE APPLIED.

包装状態図
PACKAGING FORM

MODEL NO. 53375-***9*

REVISED EC NO: J2008-3989 DRWN: MAKURAA 2008/06/23 CHKD: T. HARUYAMA 2008/06/23 APPR: NUKITA 2008/11/18	GENERAL TOLERANCES (UNLESS SPECIFIED)		DIMENSION STYLE MM ONLY		SCALE ---	DESIGN UNITS METRIC	THIRD ANGLE PROJECTION	
	10 UNDER	±0.2	DRAWN BY M. UEDA	DATE 2005/01/21	TITLE 2.5 WIRE TO BOARD CONN. WAFER ASS RADIAL TAPING -LEAD FREE-			
	10 OVER 30 UNDER	±0.25	CHECKED BY K. TOYODA	DATE 2005/01/21	MOLEX INCORPORATED			
	30 OVER	±0.3	APPROVED BY N. UKITA	DATE 2005/01/21	DOCUMENT NO. SD-53375-004			
A	ANGULAR ±3 °	DRAFT WHERE APPLICABLE MUST REMAIN WITHIN DIMENSIONS		MATERIAL NO. SEE TABLE		SHEET NO. 2 OF 3		
				THIS DRAWING CONTAINS INFORMATION THAT IS PROPRIETARY TO MOLEX INCORPORATED AND SHOULD NOT BE USED WITHOUT WRITTEN PERMISSION				

	53375-0893	53375-0892	53375-0891	53375-0890	8
		53375-0792		53375-0790	7
53375-0694	53375-0693	53375-0692		53375-0690	6
		53375-0592	53375-0591	53375-0590	5
		53375-0492	53375-0491	53375-0490	4
53375-0394	53375-0393	53375-0392	53375-0391	53375-0390	3
53375-0294	53375-0293	53375-0292	53375-0291	53375-0290	2
53375-***94 COLOR : BLUE	53375-***93 COLOR : YELLOW	53375-***92 COLOR : RED	53375-***91 COLOR : BLACK	53375-***90 COLOR : NATURAL (WHITE)	CKT.
MATERIAL No.					

REVISED EC NO: J2008-3989 DRWN:NAKURAA 2008/06/23 CHKD:T. HARUYAMA 2008/06/23 APPR:NUKITA 2008/11/18	GENERAL TOLERANCES (UNLESS SPECIFIED)		DIMENSION STYLE MM ONLY		SCALE 3:1	DESIGN UNITS METRIC	<input checked="" type="checkbox"/> THIRD ANGLE PROJECTION	
	10 UNDER	±0.2	DRAWN BY M.UMEDA	DATE 2005/01/21	TITLE 2.5 WIRE TO BOARD CONN. WAFER ASSY RADIAL TAPING -LEAD FREE-			
	10 OVER 30 UNDER	±0.25	CHECKED BY K.TOYODA	DATE 2005/01/21				
	30 OVER	±0.3	APPROVED BY N.UKITA	DATE 2005/01/21				
ANGULAR ±3 °		MATERIAL NO. SEE TABLE		DOCUMENT NO. SD-53375-004		SHEET NO. 3 OF 3		
DRAFT WHERE APPLICABLE MUST REMAIN WITHIN DIMENSIONS		THIS DRAWING CONTAINS INFORMATION THAT IS PROPRIETARY TO MOLEX INCORPORATED AND SHOULD NOT BE USED WITHOUT WRITTEN PERMISSION						