

## Easy-to-Use, Low-Power, 1°C, Low-Supply TEMPERATURE RANGE MONITOR in MicroPackage

Check for Samples: [TMP303A](#), [TMP303B](#)

### FEATURES

- **LOW POWER:** 5 $\mu$ A (max)
- **SOT563 PACKAGE:** 1,6 x 1,6 x 0,6 mm
- **TRIP POINT ACCURACY:**  $\pm 0.2^{\circ}\text{C}$  from  $-40^{\circ}\text{C}$  to  $+125^{\circ}\text{C}$
- **PUSH-PULL OUTPUT**
- **SELECTABLE HYSTERESIS:** 1/2/5/10 $^{\circ}\text{C}$
- **SUPPLY VOLTAGE RANGE:** 1.4V to 3.6V

### APPLICATIONS

- CELL PHONE HANDSETS
- PORTABLE MEDIA PLAYERS
- CONSUMER ELECTRONICS
- SERVERS
- POWER-SUPPLY SYSTEMS
- DC-DC MODULES
- THERMAL MONITORING
- ELECTRONIC PROTECTION SYSTEMS

### DESCRIPTION

The TMP303A and TMP303B are temperature range monitors that offer design flexibility through an extra small footprint (SOT563), low power (5 $\mu$ A max) and low supply voltage capability (as low as 1.4V).

These devices require no additional components for operation; each can function independent of microprocessors or microcontrollers.

Trip points are preprogrammed at the factory. For applications that require different values, contact your local TI representative.

The OUT pin is a push-pull, active-high output. When the measured temperature is beyond the trip point range of 0 $^{\circ}\text{C}$  to +60 $^{\circ}\text{C}$  (TMP303A), and the Set Output High (SOH) pin is low, the OUT pin is high. The SOH pin is an input pin with an internal pulldown resistor. When the SOH pin is forced high, the OUT pin goes high regardless of the measured temperature.

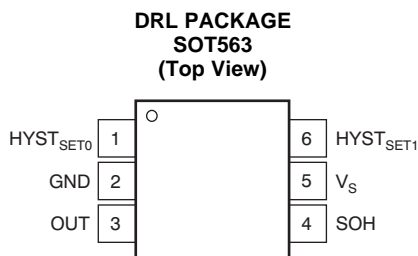

### TMP303A/B HYSTERESIS SETTINGS

HYST <sub>SET1</sub>	HYST <sub>SET0</sub>	HYSTERESIS ( $^{\circ}\text{C}$ )
GND	GND	1
GND	V <sub>S</sub>	2
V <sub>S</sub>	GND	5
V <sub>S</sub>	V <sub>S</sub>	10

### DEVICE SUMMARY

DEVICE	TRIP POINTS ( $^{\circ}\text{C}$ )
TMP303A	T <sub>L</sub> = 0, T <sub>H</sub> = +60 <sup>(1)</sup>
TMP303B	T <sub>L</sub> = 0, T <sub>H</sub> = +55 <sup>(1)</sup>

(1) Contact TI representative for other trip points.



Please be aware that an important notice concerning availability, standard warranty, and use in critical applications of Texas Instruments semiconductor products and disclaimers thereto appears at the end of this data sheet.

All trademarks are the property of their respective owners.



This integrated circuit can be damaged by ESD. Texas Instruments recommends that all integrated circuits be handled with appropriate precautions. Failure to observe proper handling and installation procedures can cause damage.

ESD damage can range from subtle performance degradation to complete device failure. Precision integrated circuits may be more susceptible to damage because very small parametric changes could cause the device not to meet its published specifications.

**PACKAGE INFORMATION<sup>(1)</sup>**

PRODUCT	PACKAGE	PACKAGE DESIGNATOR	PACKAGE MARKING
TMP303A	SOT563	DRL	OCO
TMP303B			QWM

(1) For the most current package and ordering information see the Package Option Addendum at the end of this document, or see the device product folder at [www.ti.com](http://www.ti.com).

**ABSOLUTE MAXIMUM RATINGS<sup>(1)</sup>**

		TMP303A, TMP303B	UNIT
Supply Voltage, $V_S - GND$		+3.6	V
Input Pins, Voltage	SOH, HYST <sub>SET1</sub> , HYST <sub>SET0</sub>	-0.5 to $V_S + 0.5$	V
Output Pin, Voltage	OUT	-0.5 to $V_S + 0.5$	V
Output Pin, Current	OUT	8	mA
Operating Temperature Range		-55 to +130	°C
Storage Temperature Range		-60 to +150	°C
Junction Temperature ( $T_J$ max)		+150	°C
ESD Rating	Human Body Model (HBM)	2000	V
	Charged Device Model (CDM)	1000	V
	Machine Model (MM)	200	V

(1) Stresses above these ratings may cause permanent damage. Exposure to absolute maximum conditions for extended periods may degrade device reliability. These are stress ratings only, and functional operation of the device at these or any other conditions beyond those specified is not supported.

## ELECTRICAL CHARACTERISTICS

 At  $T_A = -40^\circ\text{C}$  to  $+125^\circ\text{C}$  and  $V_S = 1.4\text{V}$  to  $3.6\text{V}$ , unless otherwise noted.

PARAMETER	CONDITIONS	TMP303A, TMP303B <sup>(1)</sup>			UNIT
		MIN	TYP	MAX	
<b>TEMPERATURE MEASUREMENT</b>					
$T_L, T_H$ Trip Point Accuracy <sup>(2)</sup>	$T_A = +55^\circ\text{C}$ to $+60^\circ\text{C}$ , $V_S = 3.3\text{V}$ $T_A = 60^\circ\text{C}$ , $V_S = 1.4\text{V}$ to $3.6\text{V}$		$\pm 0.2$	$\pm 1$	$^\circ\text{C}$
vs. Supply			$\pm 0.2$	$\pm 1.5$	$^\circ\text{C/V}$
Hysteresis	See <a href="#">Hysteresis Settings</a> table on front page	1		10	$^\circ\text{C}$
<b>HYSTERESIS SET INPUT</b>					
Input Logic Levels:					
$V_{IH}$		$0.7 \times V_S$		3.6	V
$V_{IL}$		-0.5		$0.3 \times V_S$	V
Input Current:					
$I_{IN}$	$0 < V_{IN} < 3.6\text{V}$			1	$\mu\text{A}$
<b>SOH INPUT</b>					
Pulldown Resistor Value		80	100	120	k $\Omega$
Input Logic Levels:					
$V_{IH}$		$0.7 \times V_S$		3.6	V
$V_{IL}$		-0.5		$0.3 \times V_S$	V
Input Current	$V_{IN} = 3.6\text{V}$		36		$\mu\text{A}$
<b>OUTPUT</b>					
Output Logic Levels					
$V_{OH}$	$V_S > 2\text{V}$ , $I_{OH} = 0.5\text{mA}$ $V_S < 2\text{V}$ , $I_{OH} = 0.5\text{mA}$	$V_S - 0.4$ $V_S - 0.2 \times (V_S)$		$V_S$ $V_S$	V V
$V_{OL}$	$V_S > 2\text{V}$ , $I_{OL} = 1\text{mA}$ $V_S < 2\text{V}$ , $I_{OL} = 1\text{mA}$	0 0		0.4 $0.2 \times V_S$	V V
<b>POWER SUPPLY</b>					
Specified Supply Voltage Range	$V_S$	1.4		3.6	V
Power-up Start-up Time	$V_S > 1.4\text{V}$	20	28	35	ms
Quiescent Current	$I_Q$ $T_A = -55^\circ\text{C}$ to $+60^\circ\text{C}$ $T_A = -40^\circ\text{C}$ to $+125^\circ\text{C}$		3.5 4	5 8	$\mu\text{A}$ $\mu\text{A}$
<b>TEMPERATURE RANGE</b>					
Specified Range		-40		+125	$^\circ\text{C}$
Operating Range		-55		+130	$^\circ\text{C}$
Thermal Resistance, DRL	$\theta_{JA}$ JEDEC Low-K Board		260		$^\circ\text{C/W}$

 (1) 100% of all units are production tested at  $T_A = +25^\circ\text{C}$ . Over temperature specifications are specified by design.

 (2)  $T_L, T_H$  are device-specific. For example, TMP303A  $T_L = 0^\circ\text{C}$ ,  $T_H = 60^\circ\text{C}$ ; TMP303B  $T_L = 0^\circ\text{C}$ ,  $T_H = 55^\circ\text{C}$

## TYPICAL CHARACTERISTICS

At  $V_S = +3.3V$  and  $T_A = +25^\circ C$ , unless otherwise noted.

**TRIP ACCURACY ERROR vs TEMPERATURE**

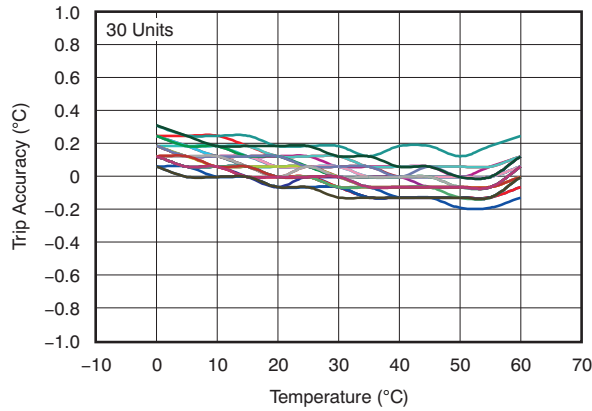

Figure 1.

**QUIESCENT CURRENT vs TEMPERATURE**

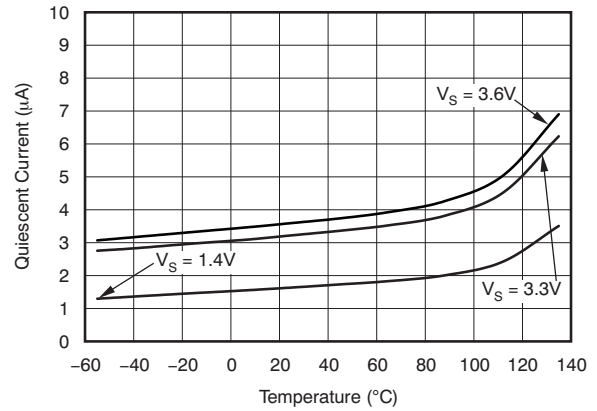

Figure 2.

**TEMPERATURE STEP RESPONSE IN PERFLUORINATED FLUID AT +100°C vs TIME**

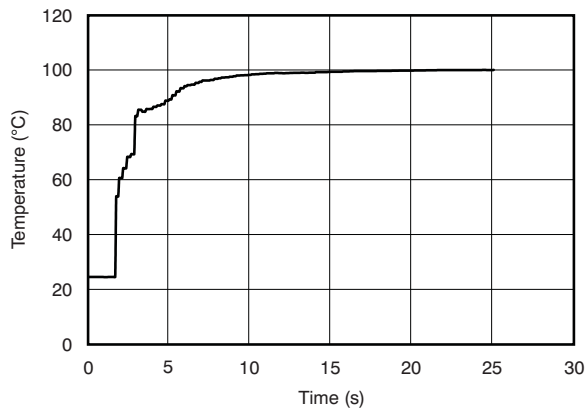

Figure 3.

**THERMAL STEP RESPONSE IN AIR AT +100°C vs TIME**

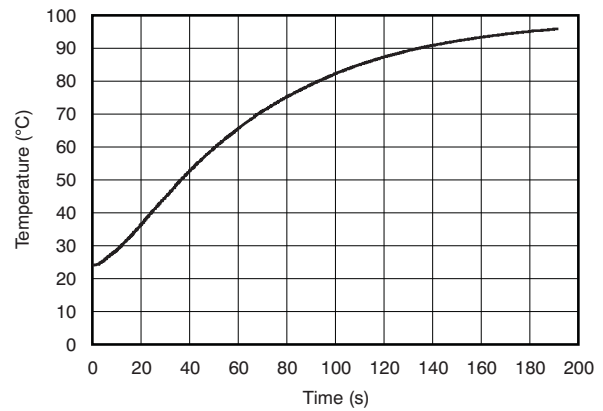

Figure 4.

**TRIP THRESHOLD ACCURACY**

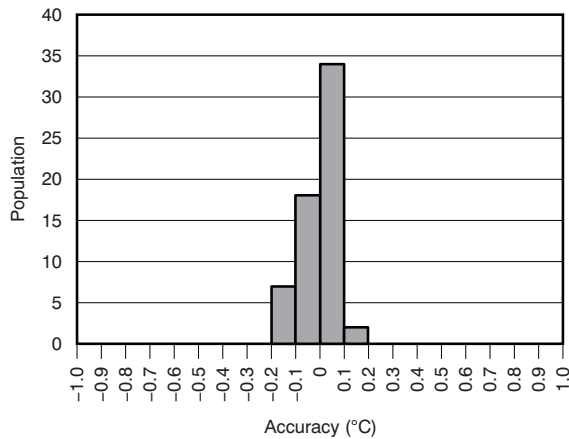

Figure 5.

**POWER-UP AND POWER-DOWN TRANSIENT RESPONSE**

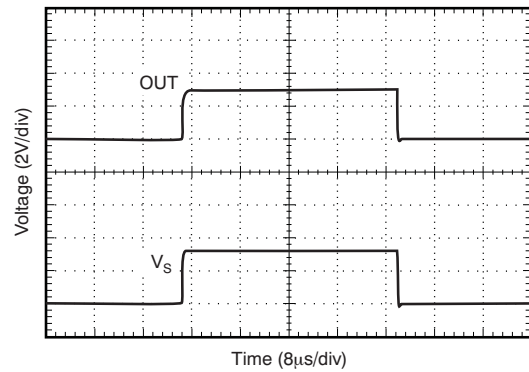
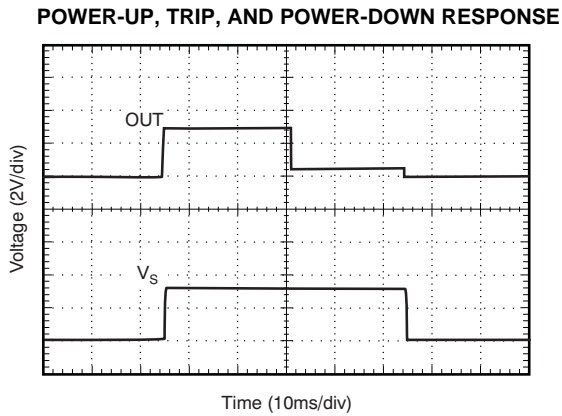

Figure 6.

**TYPICAL CHARACTERISTICS (continued)**

At  $V_S = +3.3V$  and  $T_A = +25^\circ C$ , unless otherwise noted.



**Figure 7.**

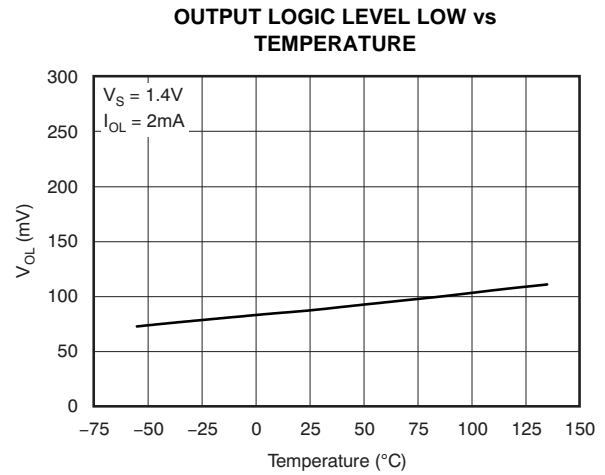

**Figure 8.**

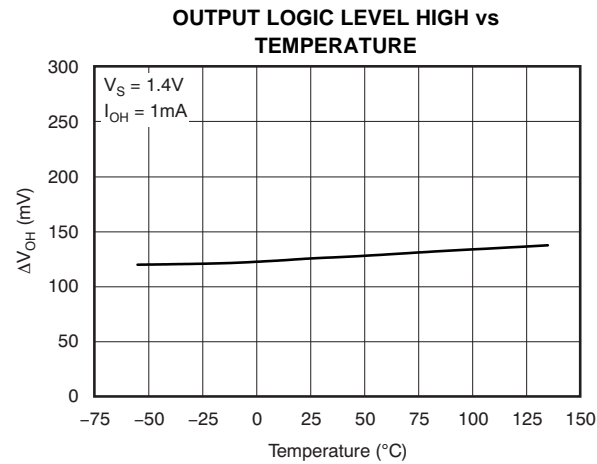

**Figure 9.**

## APPLICATION INFORMATION

The TMP303A and TMP303B are temperature switches used in battery-powered applications that require accurate monitoring of a very specific temperature range of 0°C to +60°C (TMP303A) or 0°C to +55°C (TMP303B). This functionality is accomplished through the preset trip window and two hysteresis bits,  $\text{HYST}_{\text{SET}0}$  and  $\text{HYST}_{\text{SET}1}$ . The preset trip window temperature thresholds are configured at the factory; for other trip points, contact a TI representative. Table 1 summarizes the bit setting versus hysteresis temperature window.

**Table 1. Bit Setting vs Hysteresis Window**

$\text{HYST}_{\text{SET}1}$	$\text{HYST}_{\text{SET}0}$	HYSTERESIS
GND	GND	1°C
GND	$V_S$	2°C
$V_S$	GND	5°C
$V_S$	$V_S$	10°C

### Configuring the TMP303A/B

The TMP303A/B contains an active high, *push-pull* output stage and does not require a pull-up resistor to  $V_S$  for proper operation. Figure 10 shows a block diagram of the TMP303A/B.

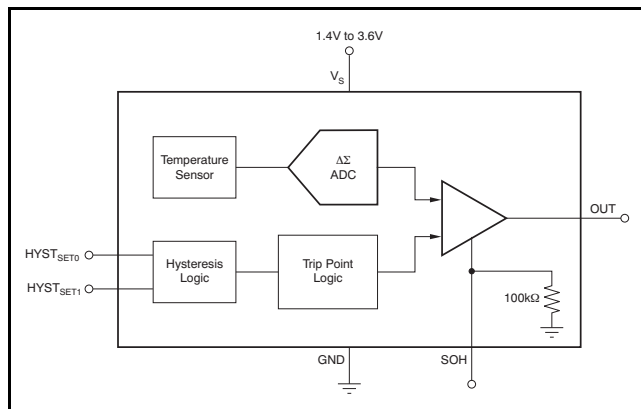
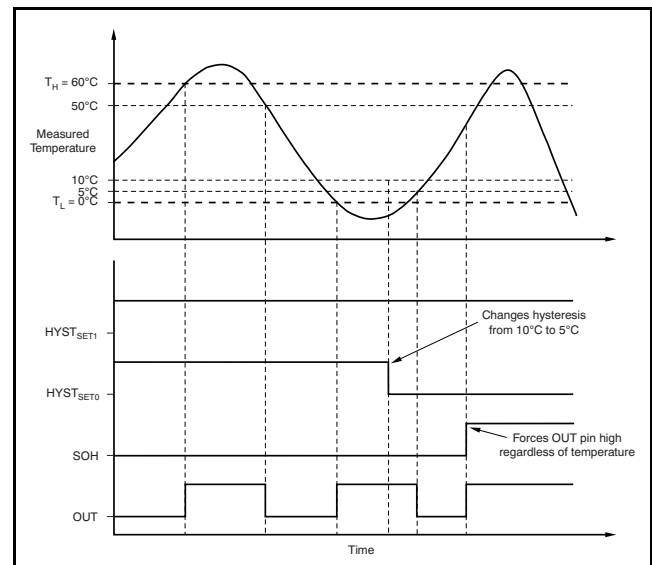

**Figure 10. TMP303A/B Block Diagram**

Power-supply bypassing is strongly recommended; use a 0.1μF capacitor placed as close as possible to the supply pin.

The TMP303A temperature trip window resides within the range of 0°C to 60°C. The TMP303B temperature trip window resides within the range of 0°C to 55°C. When either of these trip thresholds is crossed, the output (OUT) changes state from low to high. OUT does not return to its original low state until the temperature crosses the hysteresis threshold and returns within the range of the 0°C to 60°C (or 0°C to 55°C) window.

As an example, if the TMP303A is configured with a 10°C hysteresis window (that is,  $\text{HYST}_{\text{SET}0} = \text{HYST}_{\text{SET}1} = V_S$ ), the output does not return to its low state until the temperature either crosses  $(T_L + \text{hysteresis}) = 10^\circ\text{C}$  or  $(T_H - \text{hysteresis}) = 50^\circ\text{C}$ . The Set Output High (SOH) pin is intended to add test functionality to verify the connectivity of the output (OUT) pin to the system controller or other temperature response system. The SOH pin is internally pulled down to ground with a 100kΩ resistor. If the SOH pin is grounded or left floating, it has no effect on the behavior of the TMP303A. If the SOH pin is pulled high, the TMP303A immediately forces the output high, regardless of temperature. It is very important to note that this response occurs even if the temperature falls within the 0°C to 60°C temperature window. Figure 11 illustrates this design in graphical form.



**Figure 11. TMP303A Output Transfer Curves with Hysteresis Change from 10°C to 5°C and SOH Functionality**

### TMP303A/B Power Up and Timing

At device power-up, the TMP303A/B exerts  $OUT = high$ , and typically requires 26ms to return to a low state only if the temperature falls within the hysteresis window set by  $HYST_{SET0}$  and  $HYST_{SET1}$ .

The tolerance of the thermal response time is largely a result of the differences in conversion time, which varies between 20ms and 35ms; likewise, this conversion does not take place after a power cycle until the supply voltage has reached a level of at least 1.4V. This sequence is illustrated in Figure 12.

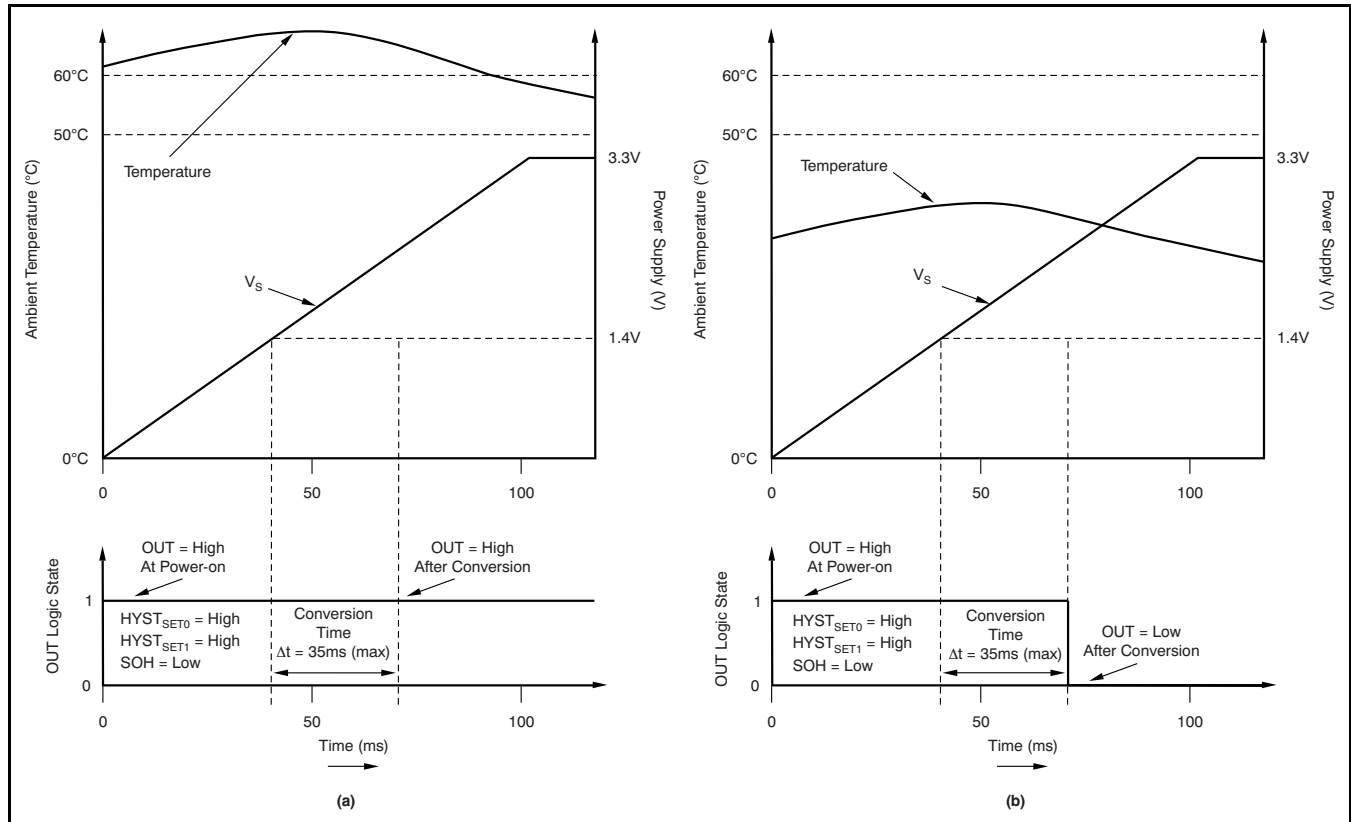

Figure 12. TMP303A Start-Up Delay vs. Output Voltage ( $HYST_{SET0} = HYST_{SET1} = V_S$ )

After the TMP303A/B powers up, all successive thermal response results for the device are achieved in a time frame of 0.985s to 1s. This period is the minimum time frame required for the push-pull output (OUT) to change its state from high to low (or vice-versa) while the device is active.

A maximum low output voltage is defined as a voltage level equivalent to  $(0.2 \times V_S)$ ; likewise, a minimum high output voltage is defined as  $(0.8 \times V_S)$ . The timing associated with start-up time and conversion is shown in Figure 13.

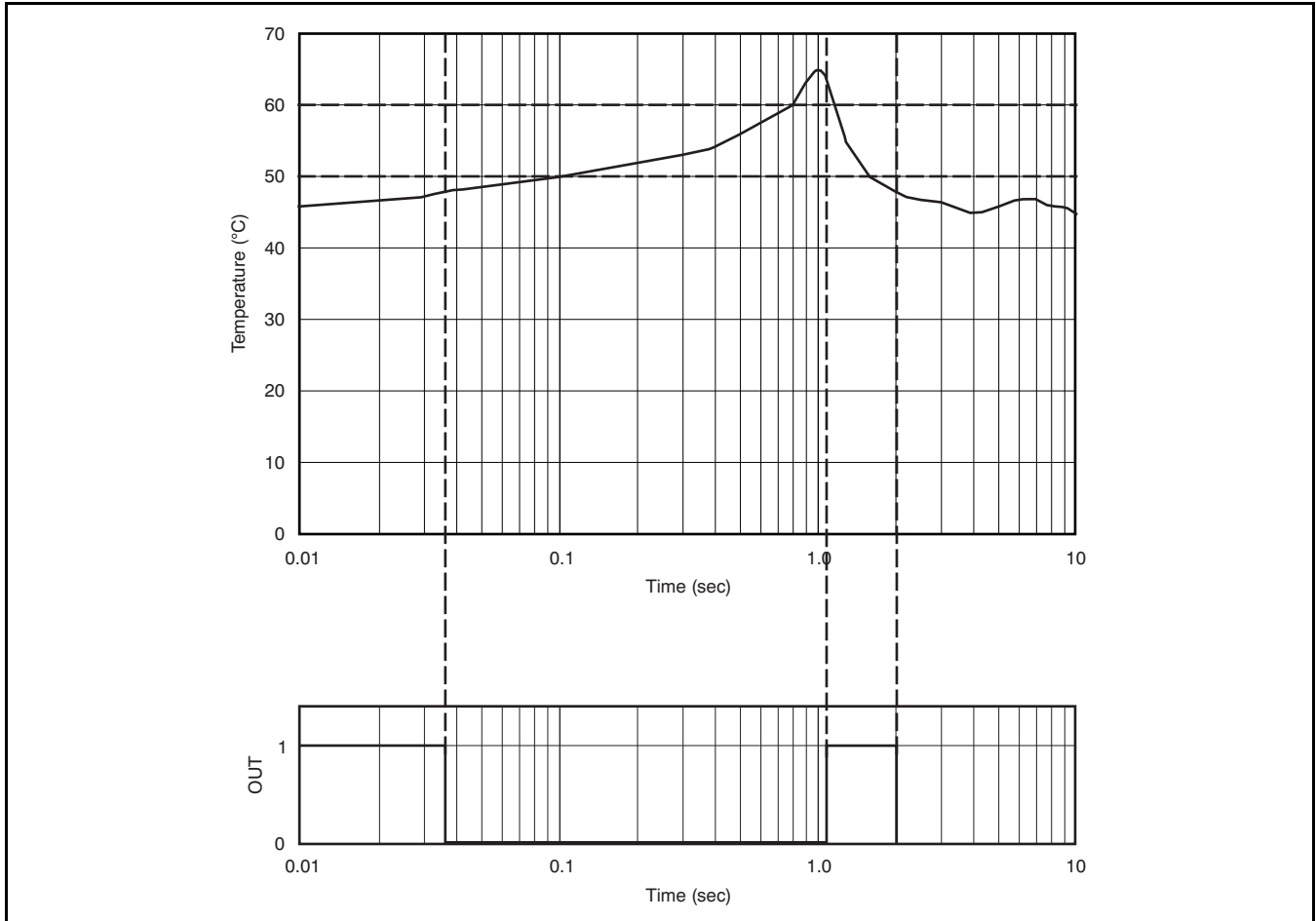

Figure 13. TMP303A Start-Up and Conversion Timing ( $HYST_{SET0} = HYST_{SET1} = V_S$ )



## REVISION HISTORY

NOTE: Page numbers for previous revisions may differ from page numbers in the current version.

<b>Changes from Revision A (September 2009) to Revision B</b>	<b>Page</b>
• Added TMP303B device to data sheet .....	<b>1</b>

**PACKAGING INFORMATION**

Orderable Device	Status <sup>(1)</sup>	Package Type	Package Drawing	Pins	Package Qty	Eco Plan <sup>(2)</sup>	Lead/ Ball Finish	MSL Peak Temp <sup>(3)</sup>	Samples (Requires Login)
TMP303ADRLR	ACTIVE	SOT	DRL	6	4000	Green (RoHS & no Sb/Br)	CU NIPDAU	Level-1-260C-UNLIM	<a href="#">Add to cart</a>
TMP303ADRLT	ACTIVE	SOT	DRL	6	250	Green (RoHS & no Sb/Br)	CU NIPDAU	Level-1-260C-UNLIM	<a href="#">Add to cart</a>
TMP303BDRLR	ACTIVE	SOT	DRL	6	4000	Green (RoHS & no Sb/Br)	CU NIPDAU	Level-1-260C-UNLIM	<a href="#">Add to cart</a>
TMP303BDRLT	ACTIVE	SOT	DRL	6	250	Green (RoHS & no Sb/Br)	CU NIPDAU	Level-1-260C-UNLIM	<a href="#">Add to cart</a>

<sup>(1)</sup> The marketing status values are defined as follows:

**ACTIVE:** Product device recommended for new designs.

**LIFEBUY:** TI has announced that the device will be discontinued, and a lifetime-buy period is in effect.

**NRND:** Not recommended for new designs. Device is in production to support existing customers, but TI does not recommend using this part in a new design.

**PREVIEW:** Device has been announced but is not in production. Samples may or may not be available.

**OBsolete:** TI has discontinued the production of the device.

<sup>(2)</sup> Eco Plan - The planned eco-friendly classification: Pb-Free (RoHS), Pb-Free (RoHS Exempt), or Green (RoHS & no Sb/Br) - please check <http://www.ti.com/productcontent> for the latest availability information and additional product content details.

**TBD:** The Pb-Free/Green conversion plan has not been defined.

**Pb-Free (RoHS):** TI's terms "Lead-Free" or "Pb-Free" mean semiconductor products that are compatible with the current RoHS requirements for all 6 substances, including the requirement that lead not exceed 0.1% by weight in homogeneous materials. Where designed to be soldered at high temperatures, TI Pb-Free products are suitable for use in specified lead-free processes.

**Pb-Free (RoHS Exempt):** This component has a RoHS exemption for either 1) lead-based flip-chip solder bumps used between the die and package, or 2) lead-based die adhesive used between the die and leadframe. The component is otherwise considered Pb-Free (RoHS compatible) as defined above.

**Green (RoHS & no Sb/Br):** TI defines "Green" to mean Pb-Free (RoHS compatible), and free of Bromine (Br) and Antimony (Sb) based flame retardants (Br or Sb do not exceed 0.1% by weight in homogeneous material)

<sup>(3)</sup> MSL, Peak Temp. -- The Moisture Sensitivity Level rating according to the JEDEC industry standard classifications, and peak solder temperature.

**Important Information and Disclaimer:** The information provided on this page represents TI's knowledge and belief as of the date that it is provided. TI bases its knowledge and belief on information provided by third parties, and makes no representation or warranty as to the accuracy of such information. Efforts are underway to better integrate information from third parties. TI has taken and continues to take reasonable steps to provide representative and accurate information but may not have conducted destructive testing or chemical analysis on incoming materials and chemicals. TI and TI suppliers consider certain information to be proprietary, and thus CAS numbers and other limited information may not be available for release.

In no event shall TI's liability arising out of such information exceed the total purchase price of the TI part(s) at issue in this document sold by TI to Customer on an annual basis.

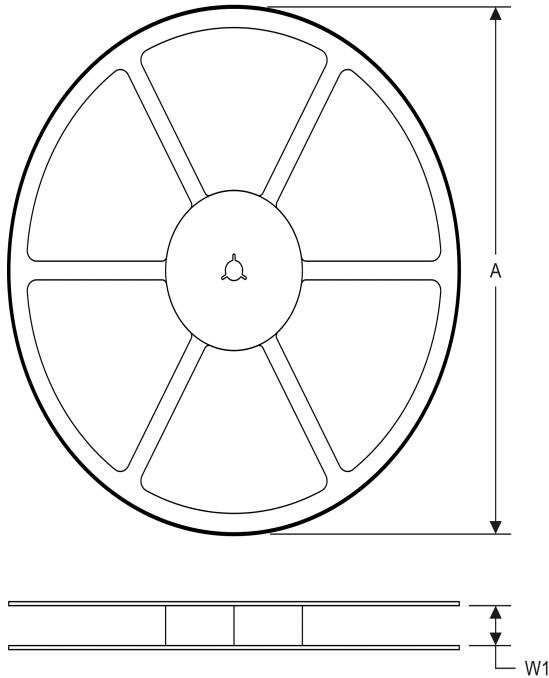
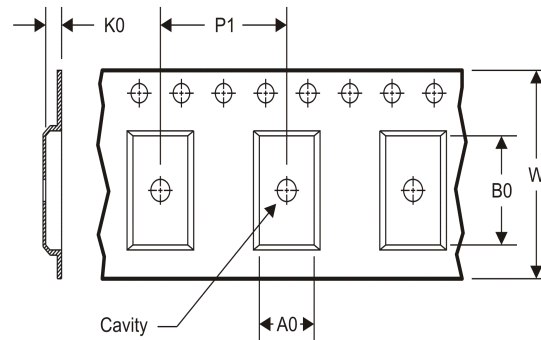
**TAPE AND REEL INFORMATION**
**REEL DIMENSIONS**

**TAPE DIMENSIONS**

A0	Dimension designed to accommodate the component width
B0	Dimension designed to accommodate the component length
K0	Dimension designed to accommodate the component thickness
W	Overall width of the carrier tape
P1	Pitch between successive cavity centers

**TAPE AND REEL INFORMATION**

\*All dimensions are nominal

Device	Package Type	Package Drawing	Pins	SPQ	Reel Diameter (mm)	Reel Width W1 (mm)	A0 (mm)	B0 (mm)	K0 (mm)	P1 (mm)	W (mm)	Pin1 Quadrant
TMP303ADRLR	SOT	DRL	6	4000	180.0	9.5	1.78	1.78	0.69	4.0	8.0	Q2
TMP303ADRLT	SOT	DRL	6	250	180.0	9.5	1.78	1.78	0.69	4.0	8.0	Q2
TMP303BDRLR	SOT	DRL	6	4000	180.0	9.5	1.78	1.78	0.69	4.0	8.0	Q2
TMP303BDRLT	SOT	DRL	6	250	180.0	9.5	1.78	1.78	0.69	4.0	8.0	Q2

**TAPE AND REEL BOX DIMENSIONS**

\*All dimensions are nominal

Device	Package Type	Package Drawing	Pins	SPQ	Length (mm)	Width (mm)	Height (mm)
TMP303ADRLR	SOT	DRL	6	4000	180.0	180.0	30.0
TMP303ADRLT	SOT	DRL	6	250	180.0	180.0	30.0
TMP303BDRLR	SOT	DRL	6	4000	180.0	180.0	30.0
TMP303BDRLT	SOT	DRL	6	250	180.0	180.0	30.0

DRL (R-PDSO-N6)

PLASTIC SMALL OUTLINE

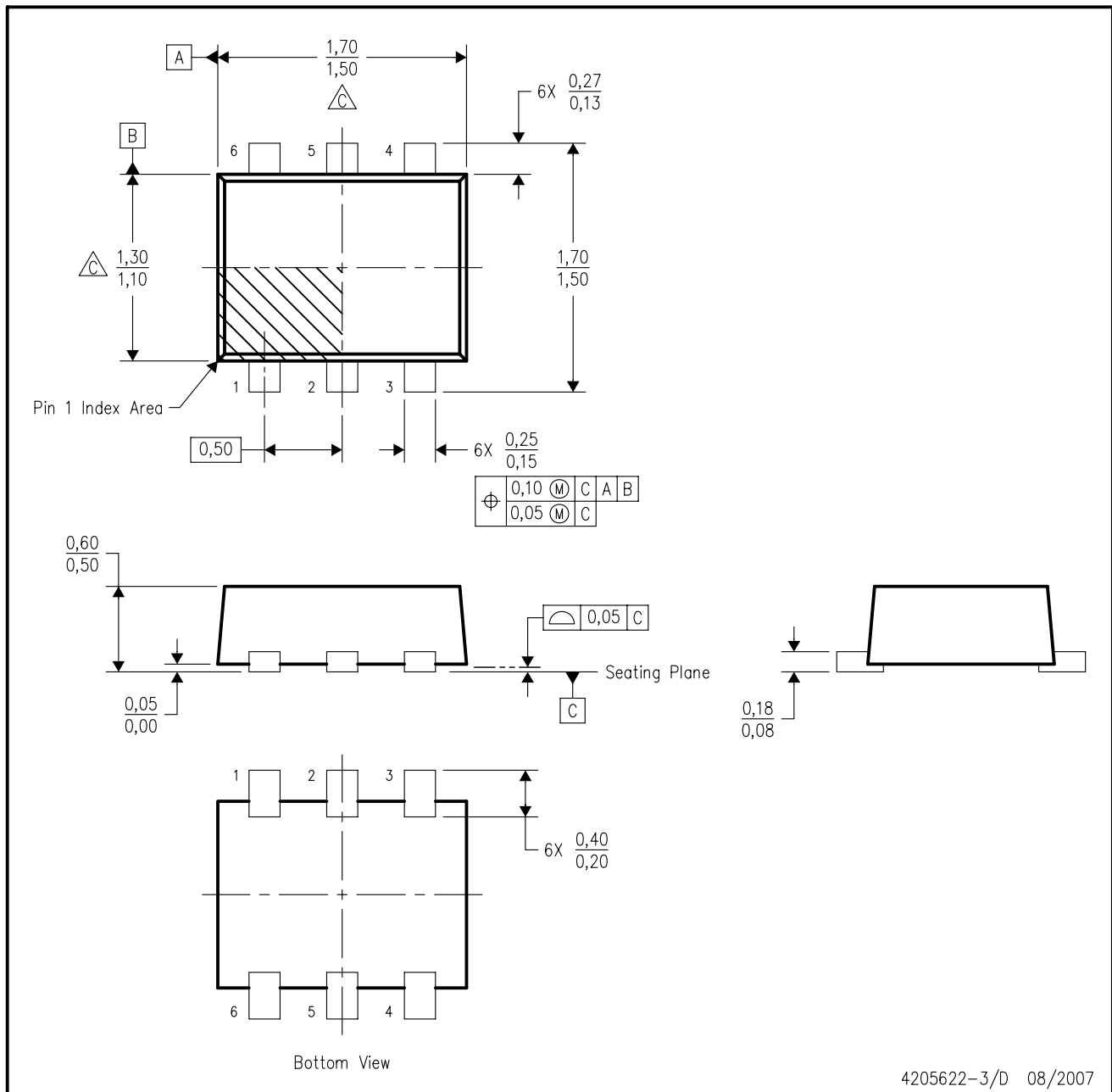

- NOTES:
- A. All linear dimensions are in millimeters. Dimensioning and tolerancing per ASME Y14.5M-1994.
  - B. This drawing is subject to change without notice.
  - C. Body dimensions do not include mold flash, interlead flash, protrusions, or gate burrs. Mold flash, interlead flash, protrusions, or gate burrs shall not exceed 0,15 per end or side.
  - D. JEDEC package registration is pending.

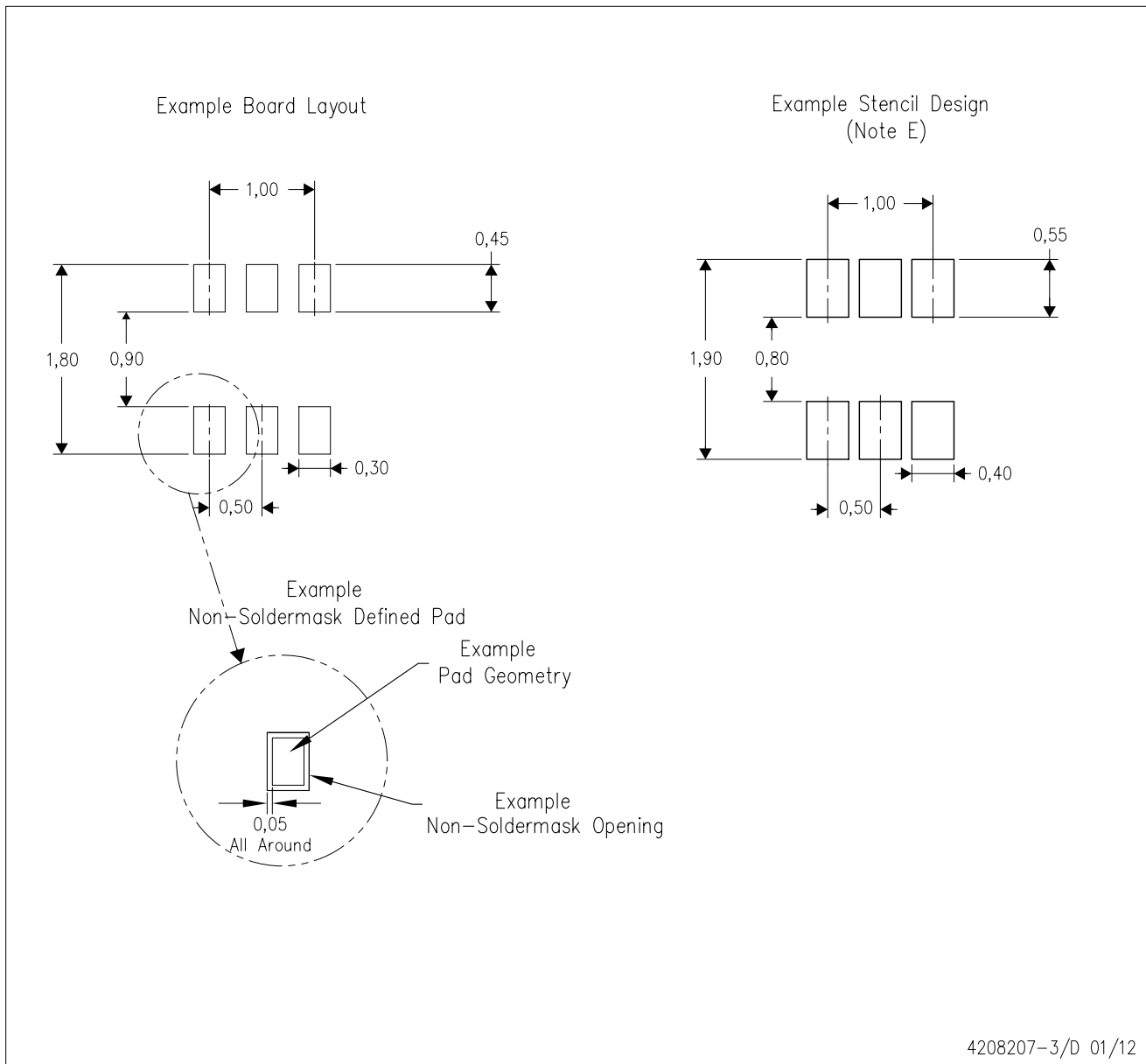

- NOTES:
- All linear dimensions are in millimeters.
  - This drawing is subject to change without notice.
  - Publication IPC-7351 is recommended for alternate designs.
  - Customers should contact their board fabrication site for minimum solder mask web tolerances between signal pads.
  - Maximum stencil thickness 0,127 mm (5 mils). All linear dimensions are in millimeters.
  - Laser cutting apertures with trapezoidal walls and also rounding corners will offer better paste release. Customers should contact their board assembly site for stencil design recommendations. Refer to IPC 7525 for stencil design considerations.
  - Side aperture dimensions over-print land for acceptable area ratio > 0.66. Customer may reduce side aperture dimensions if stencil manufacturing process allows for sufficient release at smaller opening.

## IMPORTANT NOTICE

Texas Instruments Incorporated and its subsidiaries (TI) reserve the right to make corrections, modifications, enhancements, improvements, and other changes to its products and services at any time and to discontinue any product or service without notice. Customers should obtain the latest relevant information before placing orders and should verify that such information is current and complete. All products are sold subject to TI's terms and conditions of sale supplied at the time of order acknowledgment.

TI warrants performance of its hardware products to the specifications applicable at the time of sale in accordance with TI's standard warranty. Testing and other quality control techniques are used to the extent TI deems necessary to support this warranty. Except where mandated by government requirements, testing of all parameters of each product is not necessarily performed.

TI assumes no liability for applications assistance or customer product design. Customers are responsible for their products and applications using TI components. To minimize the risks associated with customer products and applications, customers should provide adequate design and operating safeguards.

TI does not warrant or represent that any license, either express or implied, is granted under any TI patent right, copyright, mask work right, or other TI intellectual property right relating to any combination, machine, or process in which TI products or services are used. Information published by TI regarding third-party products or services does not constitute a license from TI to use such products or services or a warranty or endorsement thereof. Use of such information may require a license from a third party under the patents or other intellectual property of the third party, or a license from TI under the patents or other intellectual property of TI.

Reproduction of TI information in TI data books or data sheets is permissible only if reproduction is without alteration and is accompanied by all associated warranties, conditions, limitations, and notices. Reproduction of this information with alteration is an unfair and deceptive business practice. TI is not responsible or liable for such altered documentation. Information of third parties may be subject to additional restrictions.

Resale of TI products or services with statements different from or beyond the parameters stated by TI for that product or service voids all express and any implied warranties for the associated TI product or service and is an unfair and deceptive business practice. TI is not responsible or liable for any such statements.

TI products are not authorized for use in safety-critical applications (such as life support) where a failure of the TI product would reasonably be expected to cause severe personal injury or death, unless officers of the parties have executed an agreement specifically governing such use. Buyers represent that they have all necessary expertise in the safety and regulatory ramifications of their applications, and acknowledge and agree that they are solely responsible for all legal, regulatory and safety-related requirements concerning their products and any use of TI products in such safety-critical applications, notwithstanding any applications-related information or support that may be provided by TI. Further, Buyers must fully indemnify TI and its representatives against any damages arising out of the use of TI products in such safety-critical applications.

TI products are neither designed nor intended for use in military/aerospace applications or environments unless the TI products are specifically designated by TI as military-grade or "enhanced plastic." Only products designated by TI as military-grade meet military specifications. Buyers acknowledge and agree that any such use of TI products which TI has not designated as military-grade is solely at the Buyer's risk, and that they are solely responsible for compliance with all legal and regulatory requirements in connection with such use.

TI products are neither designed nor intended for use in automotive applications or environments unless the specific TI products are designated by TI as compliant with ISO/TS 16949 requirements. Buyers acknowledge and agree that, if they use any non-designated products in automotive applications, TI will not be responsible for any failure to meet such requirements.

Following are URLs where you can obtain information on other Texas Instruments products and application solutions:

### Products

Audio	<a href="http://www.ti.com/audio">www.ti.com/audio</a>
Amplifiers	<a href="http://amplifier.ti.com">amplifier.ti.com</a>
Data Converters	<a href="http://dataconverter.ti.com">dataconverter.ti.com</a>
DLP® Products	<a href="http://www.dlp.com">www.dlp.com</a>
DSP	<a href="http://dsp.ti.com">dsp.ti.com</a>
Clocks and Timers	<a href="http://www.ti.com/clocks">www.ti.com/clocks</a>
Interface	<a href="http://interface.ti.com">interface.ti.com</a>
Logic	<a href="http://logic.ti.com">logic.ti.com</a>
Power Mgmt	<a href="http://power.ti.com">power.ti.com</a>
Microcontrollers	<a href="http://microcontroller.ti.com">microcontroller.ti.com</a>
RFID	<a href="http://www.ti-rfid.com">www.ti-rfid.com</a>
OMAP Mobile Processors	<a href="http://www.ti.com/omap">www.ti.com/omap</a>
Wireless Connectivity	<a href="http://www.ti.com/wirelessconnectivity">www.ti.com/wirelessconnectivity</a>

### Applications

Automotive and Transportation	<a href="http://www.ti.com/automotive">www.ti.com/automotive</a>
Communications and Telecom	<a href="http://www.ti.com/communications">www.ti.com/communications</a>
Computers and Peripherals	<a href="http://www.ti.com/computers">www.ti.com/computers</a>
Consumer Electronics	<a href="http://www.ti.com/consumer-apps">www.ti.com/consumer-apps</a>
Energy and Lighting	<a href="http://www.ti.com/energy">www.ti.com/energy</a>
Industrial	<a href="http://www.ti.com/industrial">www.ti.com/industrial</a>
Medical	<a href="http://www.ti.com/medical">www.ti.com/medical</a>
Security	<a href="http://www.ti.com/security">www.ti.com/security</a>
Space, Avionics and Defense	<a href="http://www.ti.com/space-avionics-defense">www.ti.com/space-avionics-defense</a>
Video and Imaging	<a href="http://www.ti.com/video">www.ti.com/video</a>

TI E2E Community Home Page

[e2e.ti.com](http://e2e.ti.com)

Mailing Address: Texas Instruments, Post Office Box 655303, Dallas, Texas 75265  
Copyright © 2012, Texas Instruments Incorporated