

# BC846/BC546 series

65 V, 100 mA NPN general-purpose transistors

Rev. 07 — 17 November 2009

Product data sheet

## 1. Product profile

### 1.1 General description

NPN general-purpose transistors in Surface Mounted Device (SMD) plastic packages.

Table 1. Product overview

Type number <sup>[1]</sup>	Package			PNP complement
	NXP	JEITA	JEDEC	
BC846	SOT23	-	TO-236AB	BC856
BC846W	SOT323	SC-70	-	BC856W
BC846T	SOT416	SC-75	-	BC856T
BC546A <sup>[2]</sup>	SOT54	SC-43A	TO-92	BC556A
BC546B <sup>[2]</sup>	SOT54	SC-43A	TO-92	BC556B

[1] Valid for all available selection groups.

[2] Also available in SOT54A and SOT54 variant packages (see [Section 2](#)).

### 1.2 Features

- General-purpose transistors
- SMD plastic packages
- Two different gain selections

### 1.3 Applications

- General-purpose switching and amplification

### 1.4 Quick reference data

Table 2. Quick reference data

Symbol	Parameter	Conditions	Min	Typ	Max	Unit
$V_{CE0}$	collector-emitter voltage	open base	-	-	65	V
$I_C$	collector current		-	-	100	mA
$h_{FE}$	DC current gain	$V_{CE} = 5\text{ V};$ $I_C = 2\text{ mA}$	110	-	450	
	$h_{FE}$ group A		110	180	220	
	$h_{FE}$ group B		200	290	450	

## 2. Pinning information

**Table 3. Pinning**

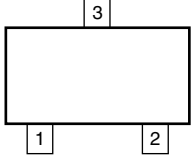
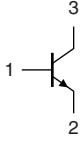
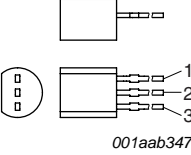
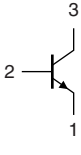
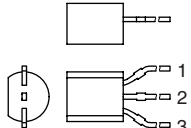
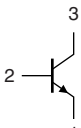
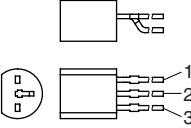
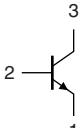
Pin	Description	Simplified outline	Symbol
<b>SOT23; SOT323; SOT416</b>			
1	base	 <p>006aaa144</p>	 <p>sym021</p>
2	emitter		
3	collector		
<b>SOT54</b>			
1	emitter	 <p>001aab347</p>	 <p>sym026</p>
2	base		
3	collector		
<b>SOT54A</b>			
1	emitter	 <p>001aab348</p>	 <p>sym026</p>
2	base		
3	collector		
<b>SOT54 variant</b>			
1	emitter	 <p>001aab447</p>	 <p>sym026</p>
2	base		
3	collector		

### 3. Ordering information

Table 4. Ordering information

Type number <sup>[1]</sup>	Package		
	Name	Description	Version
BC846	-	plastic surface mounted package; 3 leads	SOT23
BC846W	SC-70	plastic surface mounted package; 3 leads	SOT323
BC846T	SC-75	plastic surface mounted package; 3 leads	SOT416
BC546A <sup>[2]</sup>	SC-43A	plastic single-ended leaded (through hole) package; 3 leads	SOT54
BC546B <sup>[2]</sup>	SC-43A	plastic single-ended leaded (through hole) package; 3 leads	SOT54

[1] Valid for all available selection groups.

[2] Also available in SOT54 and SOT54 variant packages (see [Section 2](#) and [Section 9](#)).

### 4. Marking

Table 5. Marking codes

Type number	Marking code <sup>[1]</sup>	Type number	Marking code <sup>[1]</sup>
BC846	1D*	BC846T	1M
BC846A	1A*	BC846AT	1A
BC846B	1B*	BC846BT	1B
BC846W	1D*	BC546A	C546A
BC846AW	1A*	BC546B	C546B
BC846BW	1B*	-	-

[1] \* = -: made in Hong Kong  
 \* = p: made in Hong Kong  
 \* = t: made in Malaysia  
 \* = W: made in China

## 5. Limiting values

**Table 6. Limiting values**

*In accordance with the Absolute Maximum Rating System (IEC 60134).*

Symbol	Parameter	Conditions	Min	Max	Unit
$V_{CBO}$	collector-base voltage	open emitter	-	80	V
$V_{CEO}$	collector-emitter voltage	open base	-	65	V
$V_{EBO}$	emitter-base voltage	open collector	-	6	V
$I_C$	collector current		-	100	mA
$I_{CM}$	peak collector current	single pulse; $t_p \leq 1$ ms	-	200	mA
$I_{BM}$	peak base current	single pulse; $t_p \leq 1$ ms	-	200	mA
$P_{tot}$	total power dissipation	$T_{amb} \leq 25$ °C	[1]		
	SOT23		-	250	mW
	SOT323		-	200	mW
	SOT416		-	150	mW
	SOT54		-	500	mW
$T_j$	junction temperature		-	150	°C
$T_{amb}$	ambient temperature		-65	+150	°C
$T_{stg}$	storage temperature		-65	+150	°C

[1] Device mounted on an FR4 Printed-Circuit Board (PCB), single-sided copper, tin-plated and standard footprint.

## 6. Thermal characteristics

**Table 7. Thermal characteristics**

Symbol	Parameter	Conditions	Min	Typ	Max	Unit
$R_{th(j-a)}$	thermal resistance from junction to ambient	in free air	[1]			
	SOT23		-	-	500	K/W
	SOT323		-	-	625	K/W
	SOT416		-	-	833	K/W
	SOT54		-	-	250	K/W

[1] Device mounted on an FR4 PCB, single-sided copper, tin-plated and standard footprint.

## 7. Characteristics

**Table 8. Characteristics**
 $T_{amb} = 25\text{ }^{\circ}\text{C}$  unless otherwise specified.

Symbol	Parameter	Conditions	Min	Typ	Max	Unit	
$I_{CBO}$	collector-base cut-off current	$V_{CB} = 30\text{ V}; I_E = 0\text{ A}$	-	-	15	nA	
		$V_{CB} = 30\text{ V}; I_E = 0\text{ A}; T_j = 150\text{ }^{\circ}\text{C}$	-	-	5	$\mu\text{A}$	
$I_{EBO}$	emitter-base cut-off current	$V_{EB} = 5\text{ V}; I_E = 0\text{ A}$	-	-	100	nA	
$h_{FE}$	DC current gain						
	$h_{FE}$ group A	$V_{CE} = 5\text{ V}; I_C = 10\text{ }\mu\text{A}$	-	180	-		
	$h_{FE}$ group B	$V_{CE} = 5\text{ V}; I_C = 10\text{ }\mu\text{A}$	-	290	-		
	DC current gain	$V_{CE} = 5\text{ V}; I_C = 2\text{ mA}$	110	-	450		
	$h_{FE}$ group A	$V_{CE} = 5\text{ V}; I_C = 2\text{ mA}$	110	180	220		
	$h_{FE}$ group B	$V_{CE} = 5\text{ V}; I_C = 2\text{ mA}$	200	290	450		
$V_{CEsat}$	collector-emitter saturation voltage	$I_C = 10\text{ mA}; I_B = 0.5\text{ mA}$	-	90	200	mV	
		$I_C = 100\text{ mA}; I_B = 5\text{ mA}$	[1]	-	200	400	mV
$V_{BEsat}$	base-emitter saturation voltage	$I_C = 10\text{ mA}; I_B = 0.5\text{ mA}$	[2]	-	760	-	mV
		$I_C = 100\text{ mA}; I_B = 5\text{ mA}$	[2]	-	900	-	mV
$V_{BE}$	base-emitter voltage	$I_C = 2\text{ mA}; V_{CE} = 5\text{ V}$	[3]	580	660	700	mV
		$I_C = 10\text{ mA}; V_{CE} = 5\text{ V}$	[3]	-	-	770	mV
$f_T$	transition frequency	$V_{CE} = 5\text{ V}; I_C = 10\text{ mA}; f = 100\text{ MHz}$	100	-	-	MHz	
$C_c$	collector capacitance	$V_{CB} = 10\text{ V}; I_E = i_e = 0\text{ A}; f = 1\text{ MHz}$	-	2	3	pF	
$C_e$	emitter capacitance	$V_{EB} = 0.5\text{ V}; I_C = i_c = 0\text{ A}; f = 1\text{ MHz}$	-	11	-	pF	
NF	noise figure	$I_C = 200\text{ }\mu\text{A}; V_{CE} = 5\text{ V}; R_S = 2\text{ k}\Omega; f = 1\text{ kHz}; B = 200\text{ Hz}$	-	2	10	dB	

[1] Pulse test:  $t_p \leq 300\text{ }\mu\text{s}; \delta \leq 0.02$ .

[2]  $V_{BEsat}$  decreases by approximately 1.7 mV/K with increasing temperature.

[3]  $V_{BE}$  decreases by approximately 2 mV/K with increasing temperature.

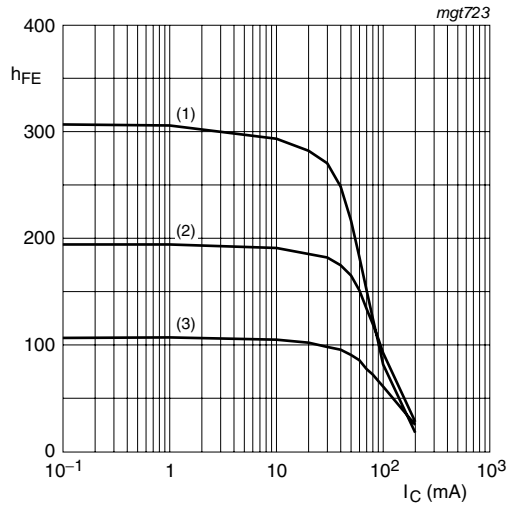

- $V_{CE} = 5\text{ V}$
- (1)  $T_{amb} = 150\text{ °C}$
  - (2)  $T_{amb} = 25\text{ °C}$
  - (3)  $T_{amb} = -55\text{ °C}$

**Fig 1. Selection A: DC current gain as a function of collector current; typical values**

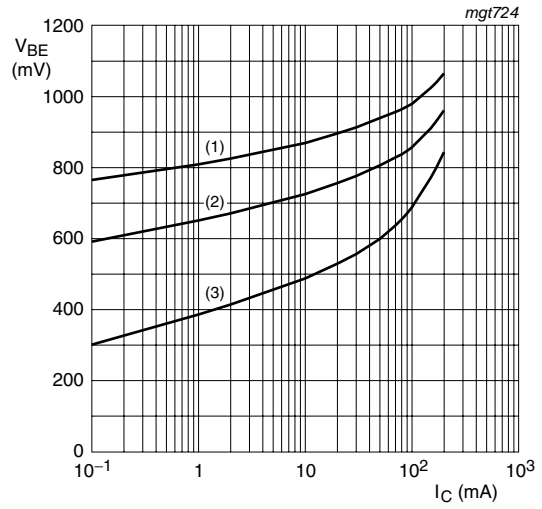

- $V_{CE} = 5\text{ V}$
- (1)  $T_{amb} = -55\text{ °C}$
  - (2)  $T_{amb} = 25\text{ °C}$
  - (3)  $T_{amb} = 150\text{ °C}$

**Fig 2. Selection A: Base-emitter voltage as a function of collector current; typical values**

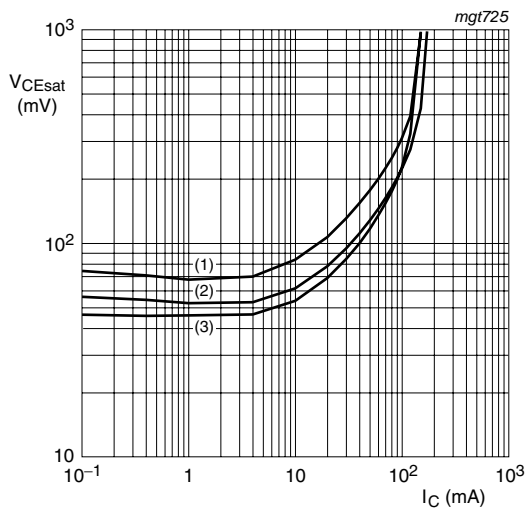

- $I_C/I_B = 20$
- (1)  $T_{amb} = 150\text{ °C}$
  - (2)  $T_{amb} = 25\text{ °C}$
  - (3)  $T_{amb} = -55\text{ °C}$

**Fig 3. Selection A: Collector-emitter saturation voltage as a function of collector current; typical values**

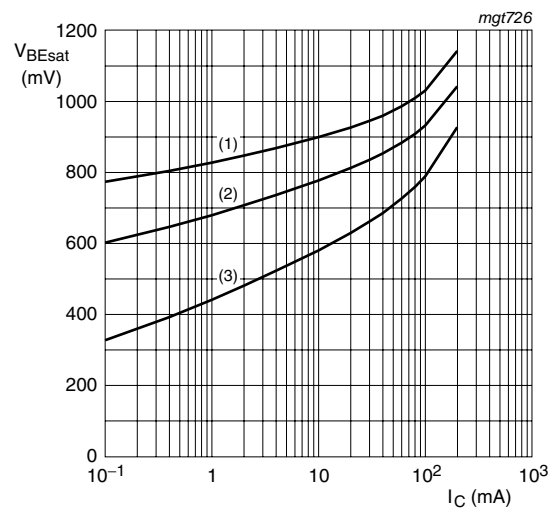

- $I_C/I_B = 10$
- (1)  $T_{amb} = -55\text{ °C}$
  - (2)  $T_{amb} = 25\text{ °C}$
  - (3)  $T_{amb} = 150\text{ °C}$

**Fig 4. Selection A: Base-emitter saturation voltage as a function of collector current; typical values**

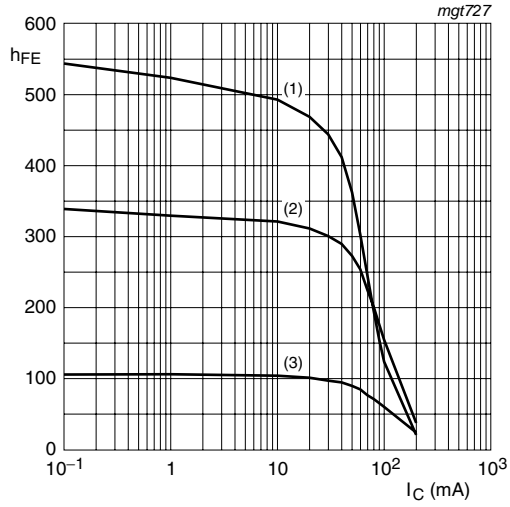

- $V_{CE} = 5\text{ V}$
- (1)  $T_{amb} = 150\text{ °C}$
  - (2)  $T_{amb} = 25\text{ °C}$
  - (3)  $T_{amb} = -55\text{ °C}$

**Fig 5. Selection B: DC current gain as a function of collector current; typical values**

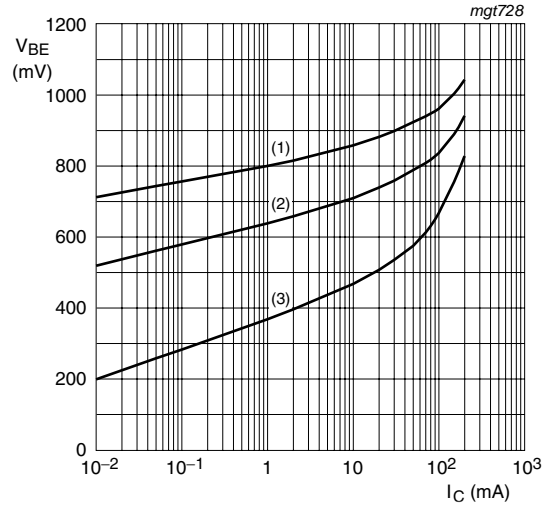

- $V_{CE} = 5\text{ V}$
- (1)  $T_{amb} = -55\text{ °C}$
  - (2)  $T_{amb} = 25\text{ °C}$
  - (3)  $T_{amb} = 150\text{ °C}$

**Fig 6. Selection B: Base-emitter voltage as a function of collector current; typical values**

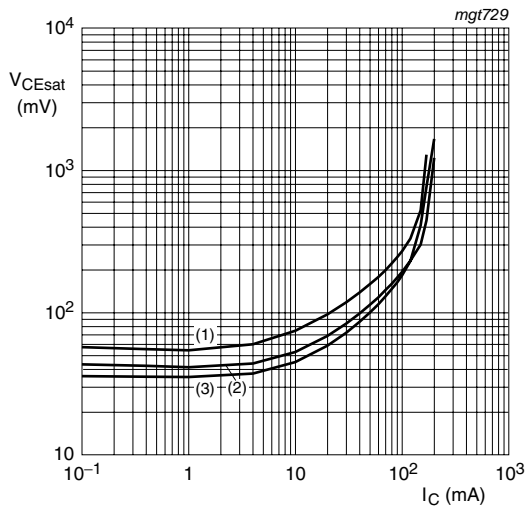

- $I_C/I_B = 20$
- (1)  $T_{amb} = 150\text{ °C}$
  - (2)  $T_{amb} = 25\text{ °C}$
  - (3)  $T_{amb} = -55\text{ °C}$

**Fig 7. Selection B: Collector-emitter saturation voltage as a function of collector current; typical values**

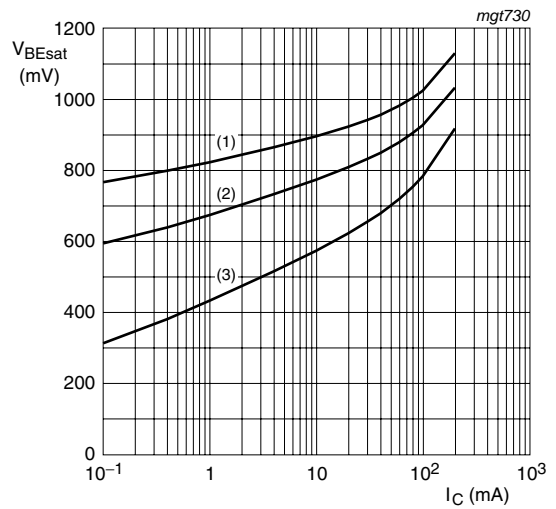

- $I_C/I_B = 10$
- (1)  $T_{amb} = -55\text{ °C}$
  - (2)  $T_{amb} = 25\text{ °C}$
  - (3)  $T_{amb} = 150\text{ °C}$

**Fig 8. Selection B: Base-emitter saturation voltage as a function of collector current; typical values**

## 8. Package outline

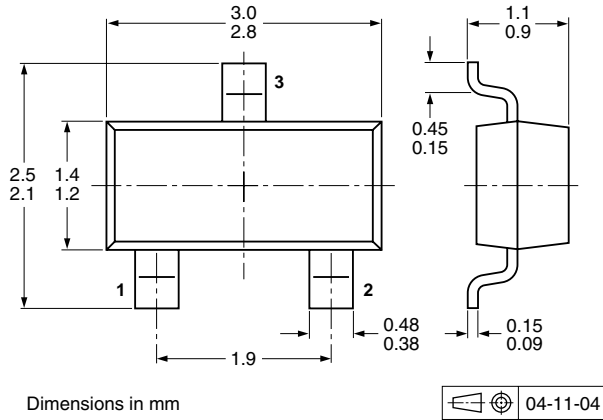

**Fig 9. Package outline SOT23 (TO-236AB)**

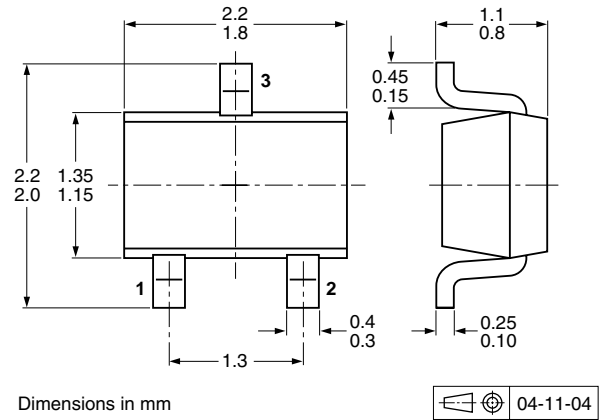

**Fig 10. Package outline SOT323 (SC-70)**

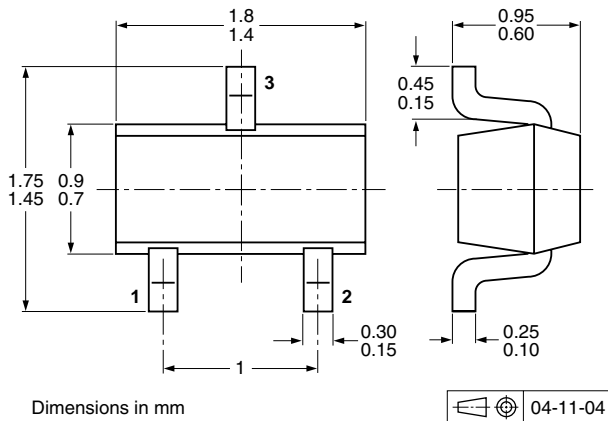

**Fig 11. Package outline SOT416 (SC-75)**

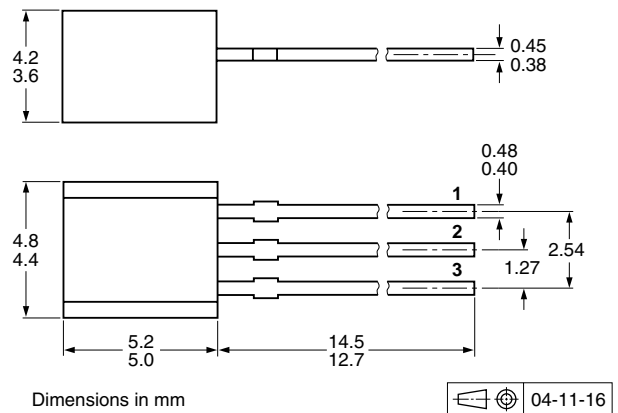

**Fig 12. Package outline SOT54 (SC-43A/TO-92)**

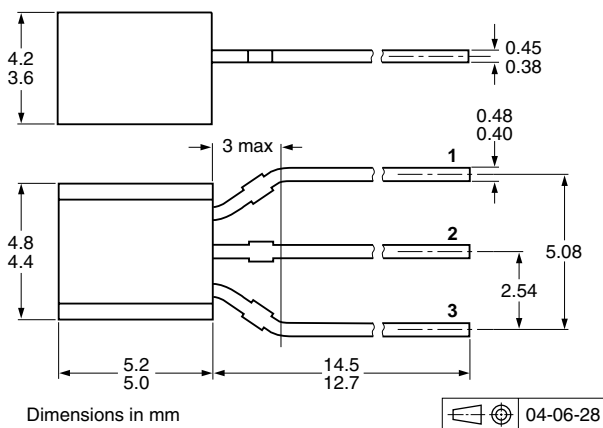

**Fig 13. Package outline SOT54A**

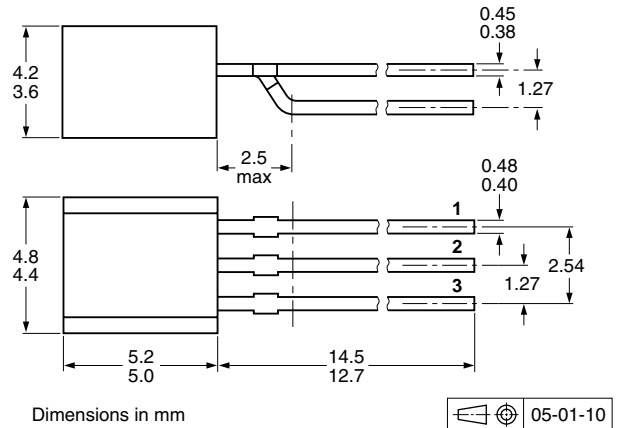

**Fig 14. Package outline SOT54 variant**



## 9. Packing information

**Table 9. Packing methods**

The indicated -xxx are the last three digits of the 12NC ordering code.<sup>[1]</sup>

Type number <sup>[2]</sup>	Package	Description	Packing quantity		
			3000	5000	10000
BC846	SOT23	4 mm pitch, 8 mm tape and reel	-215	-	-235
BC846W	SOT323	4 mm pitch, 8 mm tape and reel	-115	-	-135
BC846T	SOT416	4 mm pitch, 8 mm tape and reel	-115	-	-135
BC546A	SOT54	bulk, straight leads	-	-412	-
	SOT54A	tape and reel, wide pitch	-	-	-116
		tape ammopack, wide pitch	-	-	-126
	SOT54 variant	bulk, delta pinning	-	-112	-
BC546B	SOT54	bulk, straight leads	-	-412	-
	SOT54A	tape and reel, wide pitch	-	-	-116
		tape ammopack, wide pitch	-	-	-126
	SOT54 variant	bulk, delta pinning	-	-112	-

[1] For further information and the availability of packing methods, see [Section 13](#).

[2] Valid for all available selection groups.

**10. Soldering**

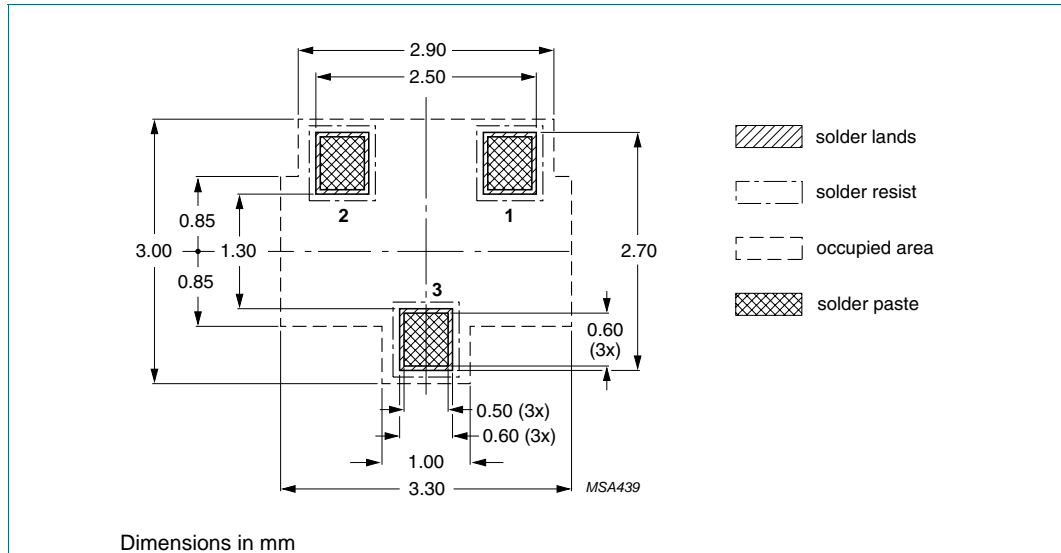

**Fig 15. Reflow soldering footprint SOT23 (TO-236AB)**

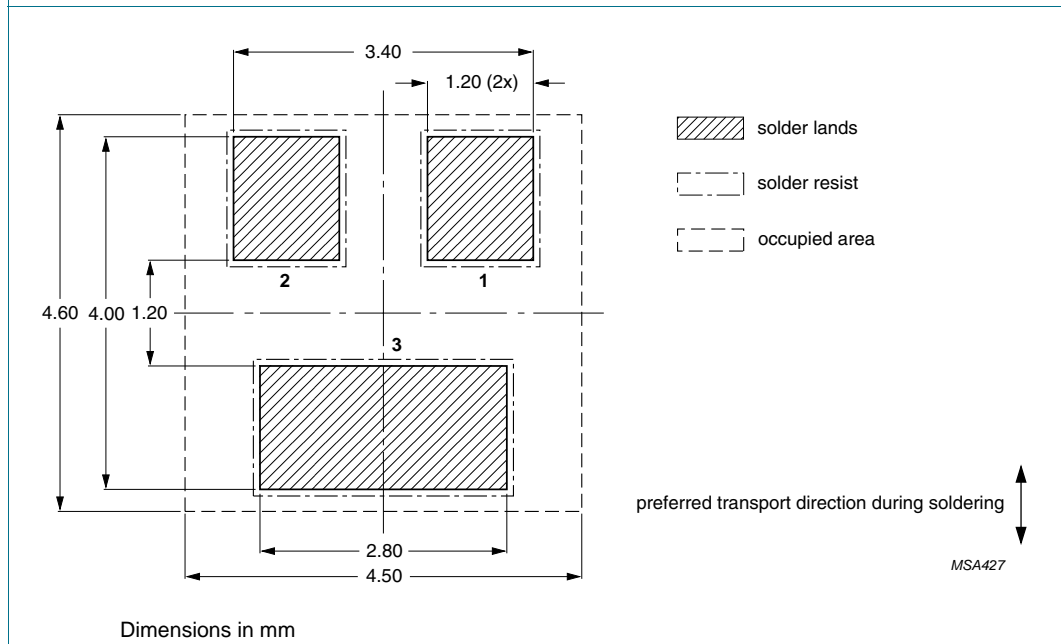

**Fig 16. Wave soldering footprint SOT23 (TO-236AB)**

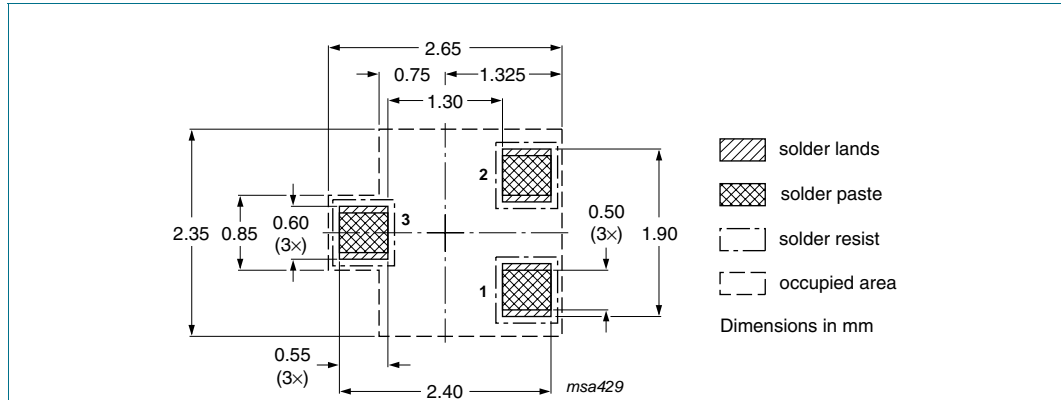

**Fig 17. Reflow soldering footprint SOT323 (SC-70)**

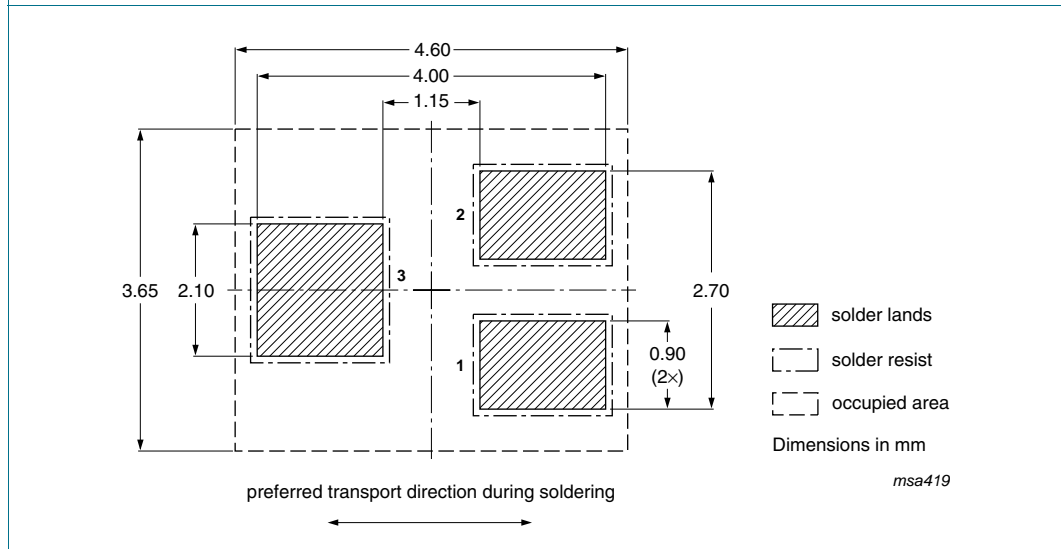

**Fig 18. Wave soldering footprint SOT323 (SC-70)**

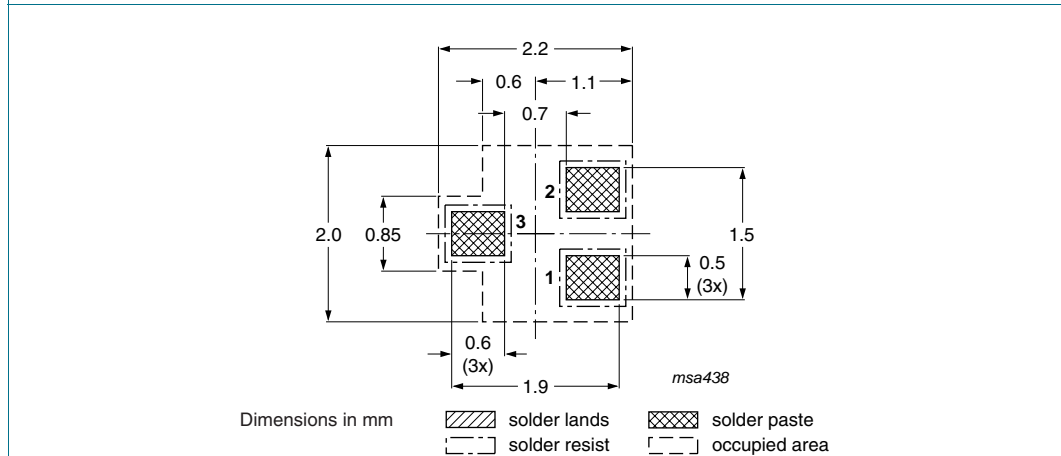

**Fig 19. Reflow soldering footprint SOT416 (SC-75)**

## 11. Revision history

Table 10. Revision history

Document ID	Release date	Data sheet status	Change notice	Supersedes
BC846_BC546_SER_7	20091117	Product data sheet	-	BC846_BC546_SER_6
Modifications:	<ul style="list-style-type: none"> <li>• This data sheet was changed to reflect the new company name NXP Semiconductors, including new legal definitions and disclaimers. No changes were made to the technical content.</li> <li>• <a href="#">Table 3 “Pinning”</a>: updated</li> <li>• <a href="#">Figure 17 “Reflow soldering footprint SOT323 (SC-70)”</a>: updated</li> <li>• <a href="#">Figure 18 “Wave soldering footprint SOT323 (SC-70)”</a>: updated</li> <li>• <a href="#">Figure 19 “Reflow soldering footprint SOT416 (SC-75)”</a>: updated</li> </ul>			
BC846_BC546_SER_6	20060207	Product data sheet	-	BC846_BC847_ BC848_5 BC846T_847T_ SERIES_3 BC846W_BC847W_ BC848W_4 BC546_547_4
BC846_BC847_BC848_5	20040206	Product specification	-	BC846_BC847_ BC848_4
BC846T_847T_SERIES_3	20001115	Product specification	-	BC846T_847T_2
BC846W_BC847W_ BC848W_4	20020204	Product specification	-	BC846W_847W_3
BC546_547_4	20041125	Product specification	-	BC546_547_3

## 12. Legal information

### 12.1 Data sheet status

Document status <sup>[1][2]</sup>	Product status <sup>[3]</sup>	Definition
Objective [short] data sheet	Development	This document contains data from the objective specification for product development.
Preliminary [short] data sheet	Qualification	This document contains data from the preliminary specification.
Product [short] data sheet	Production	This document contains the product specification.

[1] Please consult the most recently issued document before initiating or completing a design.

[2] The term 'short data sheet' is explained in section "Definitions".

[3] The product status of device(s) described in this document may have changed since this document was published and may differ in case of multiple devices. The latest product status information is available on the Internet at URL <http://www.nxp.com>.

### 12.2 Definitions

**Draft** — The document is a draft version only. The content is still under internal review and subject to formal approval, which may result in modifications or additions. NXP Semiconductors does not give any representations or warranties as to the accuracy or completeness of information included herein and shall have no liability for the consequences of use of such information.

**Short data sheet** — A short data sheet is an extract from a full data sheet with the same product type number(s) and title. A short data sheet is intended for quick reference only and should not be relied upon to contain detailed and full information. For detailed and full information see the relevant full data sheet, which is available on request via the local NXP Semiconductors sales office. In case of any inconsistency or conflict with the short data sheet, the full data sheet shall prevail.

### 12.3 Disclaimers

**General** — Information in this document is believed to be accurate and reliable. However, NXP Semiconductors does not give any representations or warranties, expressed or implied, as to the accuracy or completeness of such information and shall have no liability for the consequences of use of such information.

**Right to make changes** — NXP Semiconductors reserves the right to make changes to information published in this document, including without limitation specifications and product descriptions, at any time and without notice. This document supersedes and replaces all information supplied prior to the publication hereof.

**Suitability for use** — NXP Semiconductors products are not designed, authorized or warranted to be suitable for use in medical, military, aircraft, space or life support equipment, nor in applications where failure or malfunction of an NXP Semiconductors product can reasonably be expected to result in personal injury, death or severe property or environmental

damage. NXP Semiconductors accepts no liability for inclusion and/or use of NXP Semiconductors products in such equipment or applications and therefore such inclusion and/or use is at the customer's own risk.

**Applications** — Applications that are described herein for any of these products are for illustrative purposes only. NXP Semiconductors makes no representation or warranty that such applications will be suitable for the specified use without further testing or modification.

**Limiting values** — Stress above one or more limiting values (as defined in the Absolute Maximum Ratings System of IEC 60134) may cause permanent damage to the device. Limiting values are stress ratings only and operation of the device at these or any other conditions above those given in the Characteristics sections of this document is not implied. Exposure to limiting values for extended periods may affect device reliability.

**Terms and conditions of sale** — NXP Semiconductors products are sold subject to the general terms and conditions of commercial sale, as published at <http://www.nxp.com/profile/terms>, including those pertaining to warranty, intellectual property rights infringement and limitation of liability, unless explicitly otherwise agreed to in writing by NXP Semiconductors. In case of any inconsistency or conflict between information in this document and such terms and conditions, the latter will prevail.

**No offer to sell or license** — Nothing in this document may be interpreted or construed as an offer to sell products that is open for acceptance or the grant, conveyance or implication of any license under any copyrights, patents or other industrial or intellectual property rights.

**Export control** — This document as well as the item(s) described herein may be subject to export control regulations. Export might require a prior authorization from national authorities.

**Quick reference data** — The Quick reference data is an extract of the product data given in the Limiting values and Characteristics sections of this document, and as such is not complete, exhaustive or legally binding.

### 12.4 Trademarks

Notice: All referenced brands, product names, service names and trademarks are the property of their respective owners.

## 13. Contact information

For more information, please visit: <http://www.nxp.com>

For sales office addresses, please send an email to: [salesaddresses@nxp.com](mailto:salesaddresses@nxp.com)

**14. Contents**

**1 Product profile . . . . . 1**

1.1 General description . . . . . 1

1.2 Features . . . . . 1

1.3 Applications . . . . . 1

1.4 Quick reference data . . . . . 1

**2 Pinning information . . . . . 2**

**3 Ordering information . . . . . 3**

**4 Marking . . . . . 3**

**5 Limiting values . . . . . 4**

**6 Thermal characteristics . . . . . 4**

**7 Characteristics . . . . . 5**

**8 Package outline . . . . . 8**

**9 Packing information . . . . . 9**

**10 Soldering . . . . . 10**

**11 Revision history . . . . . 12**

**12 Legal information . . . . . 13**

12.1 Data sheet status . . . . . 13

12.2 Definitions . . . . . 13

12.3 Disclaimers . . . . . 13

12.4 Trademarks . . . . . 13

**13 Contact information . . . . . 13**

**14 Contents . . . . . 14**

Please be aware that important notices concerning this document and the product(s) described herein, have been included in section 'Legal information'.



© NXP B.V. 2009.

All rights reserved.

For more information, please visit: <http://www.nxp.com>

For sales office addresses, please send an email to: [salesaddresses@nxp.com](mailto:salesaddresses@nxp.com)

Date of release: 17 November 2009

Document identifier: BC846\_BC546\_SER\_7