

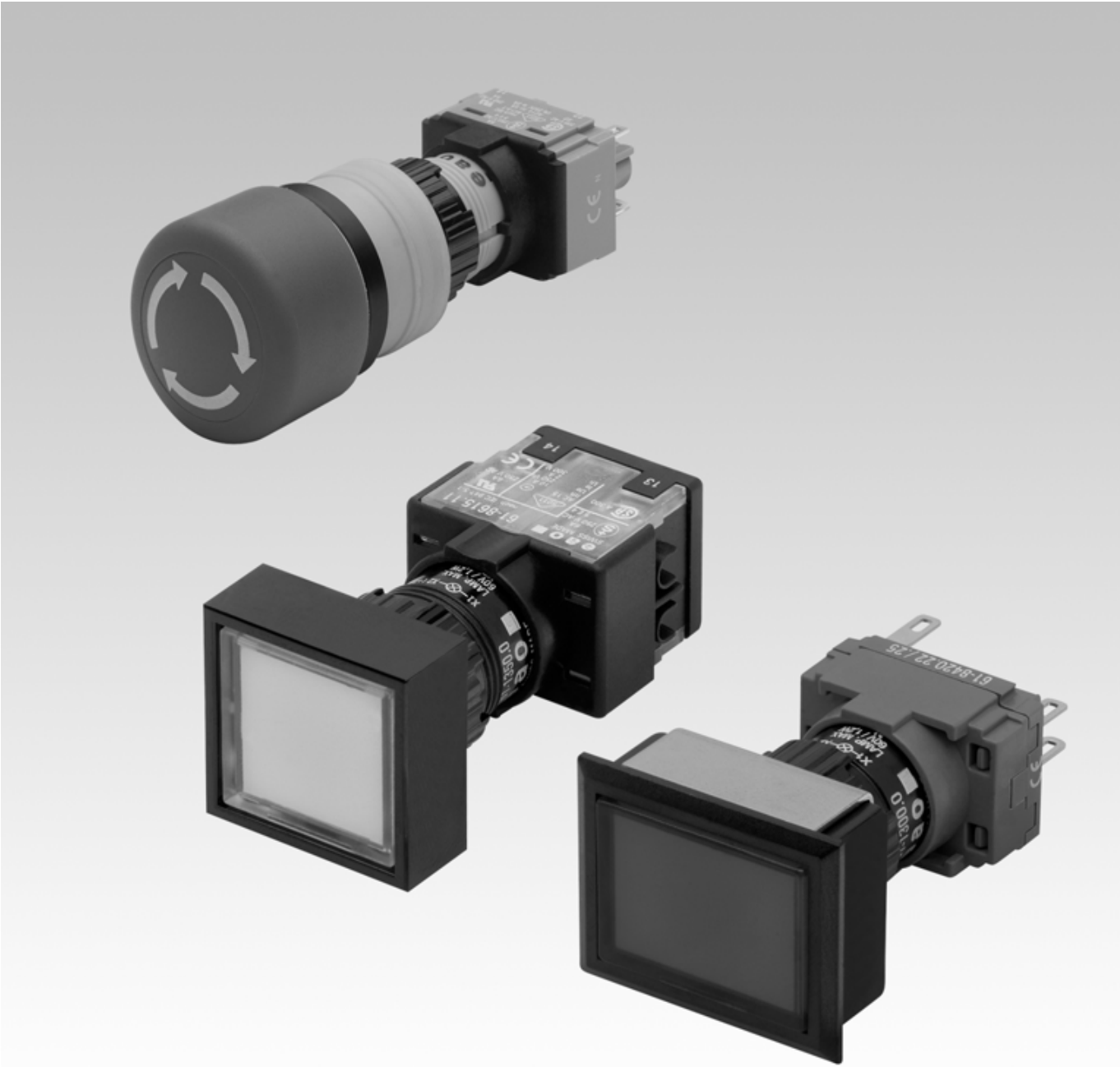

EAO Product Information

Series 61



Index

Series 61

	Description	Page 425
	Product Assembly	Page 426
	Product Range	
	- pushbuttons for standard mounting	Page 427
	- pushbuttons for flush mounting	Page 434
	- accessories / spare parts	Page 440
	Technical Data	Page 453
	Technical Drawing / Dimension / Layouts	Page 457
	Circuit Drawing	Page 467
	Typical Applications	Page 473
Marking	Page 475	

Description

General Notes

The indicators, illuminated pushbuttons, selector switches, keylock switches and emergency stop switches with spray-water protection at the front (IP 65) are modular and consist of an actuator and switching element. In addition to the standard switching elements (gold-plated silver contact with universal soldering or plug-in terminals), forced-opening, slow-make switching elements with gold or silver contacts and soldering or plug-in terminals are available. They can be supplied with screw terminals and silver contacts too. The front dimensions of the units in this series are 24 x 24 mm, 24 mm dia., 18 x 24 mm, 18 x 18 mm or 18 mm dia. For flush mounting the dimensions 25 mm dia., 24 x 30 mm and 24 x 24 mm can be supplied.

Mounting

All switch actuators are mounted from the front by pushing them through the mounting hole in the front panel. They are then fixed from the back with a fixing nut and the mounting tool typ no. 01-907. Max. tightening torque 50 Ncm. For mounting dimensions and grid size see as of page 462.

The preassembled switching element with the connecting wires in a single plane can be clipped on afterwards. For block or series mounting aids are available.

For switching elements with 2.8 mm plug-in terminals, we offer plug-in bases, which when soldered to a PCB enable a plug-in connection to the button. All actuators are provided with an anti-rotation device.

Lenses

The flat or concave lenses are available in various colours and a transparent or translucent version. The lens surface is non-reflecting (matt). Lenses 19.7 mm dia. can be supplied also in aluminium.

Marking

For engraving, hot stamping and film inserts, see page 475 under "Marking".

Illumination

The midjet-grooved T 1 3/4 incandescent lamp (6-48 V, 1.2 W) ensures perfect illumination of the lenses, which are supplied in various colours.

Midjet-grooved T 1 3/4 Multi-LED (6, 12, 24, 48 V) are also available in white, red, yellow and green.

For supply voltages above 60 V, it is necessary to use a voltage reduction element (external series resistor, capacitor or transformer).

Do not solder the terminals directly, because of the high surface temperature.

Position indication

When the switch with maintained action is actuated, the lens snaps into place mechanically. The position of contacts can always be determined by the position of the lens.

Keylock switch

Standard lock (index D)

1 standard number 311. If the lock number is not specified, we will supply no. 311. An additional 134 special locks (index X) are available on request. Master keys for locks no. 311 - 445 may be ordered by quoting no. 31-989.300.

Two keys are supplied with each keylock switch.

Spare keys for DOM standard locks may be ordered by quoting no. 31-989 (please state the lock number).

Emergency stop switch foolproof with key to unlock

Kaba safety lock. Standard lock number is 1001. Locks with other numbers are available on request.

Spare keys for KABA locks may be ordered under no. 14-987 (please state the lock number).

Specimen order

Indicator complete

- indicator complete, soldering terminal, 18 x 24 mm 61-0030.02

Recommended accessories:

- lens plastic, 18 x 24 mm, clear 61-9331.7
- LED, 6 chips, 6 VDC, yellow 10-5306.3254

All dimensions in mm.

We reserve the right to modify technical data.

illuminated-/pushbutton



- 1 lens
- 2 actuator case
- 3 fixing nut
- 4 switching element

illuminated-/pushbutton for flush mounting

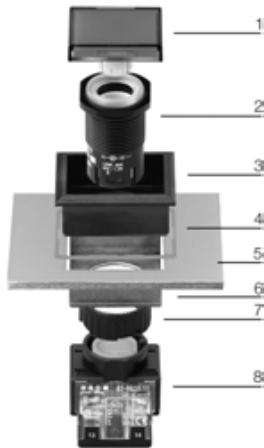

- 1 lens
- 2 actuator housing
- 3 front bezel
- 4 sealing
- 5 front panel
- 6 fixing bow
- 7 fixing nut
- 8 switching element

indicator complete



- 🛒 lens plastic page 440
- 🛒 front ring page 443
- 🛒 filament lamp page 448
- 🛒 LED page 449

	connection method					circuit drawing	technical drawing	mounting dimensions		
	☐	18 x 24 mm Typ-Nr.	24 x 24 mm Typ-Nr.	24 mm dia. Typ-Nr.	18 x 18 mm Typ-Nr.	18 mm dia. Typ-Nr.	1	1	1	0,005
indicator complete	-	61-0030.02	61-0050.02	61-0040.02	61-0020.02	61-0010.02	1	1	1	0,005

connection method : soldering-/plug-in terminal = -

Accessorie front ring only requested for 24mm dia.

circuit drawings from page 467, technical drawings from page 457, mounting dimensions from page 462

indicator actuator



- 🛒 lens plastic page 440
- 🛒 front ring page 443
- 🛒 filament lamp page 448
- 🛒 LED page 449
- 🛒 lamp element page 445
- 🛒 diode element page 445
- 🛒 flasher element page 445

						circuit drawing	technical drawing	mounting dimensions		
	☐	18 x 24 mm Typ-Nr.	24 x 24 mm Typ-Nr.	24 mm dia. Typ-Nr.	18 x 18 mm Typ-Nr.	18 mm dia. Typ-Nr.	1	2	1	0,005
indicator actuator		61-0039.0	61-0059.0	61-0049.0	61-0029.0	61-0019.0	1	2	1	0,005

Accessorie front ring only requested for 24mm dia.

circuit drawings from page 467, technical drawings from page 457, mounting dimensions from page 462

illuminated-/pushbutton actuator



- ☞ lens plastic page 440
- ☞ lens metal with window page 441
- ☞ lens metal page 441
- ☞ front ring page 443
- ☞ filament lamp page 448
- ☞ LED page 449
- ☞ switching element for illuminated-/pushbutton, keylock-/selector switch 2 positions page 446

	switching action	\square	\square		\square		circuit drawing	technical drawing	mounting dimensions	
		18 x 24 mm Typ-Nr.	24 x 24 mm Typ-Nr.	24 mm dia. Typ-Nr.	18 x 18 mm Typ-Nr.	18 mm dia. Typ-Nr.				
illuminated-/push-button actuator	M	61-1130.0	61-1150.0	61-1140.0	61-1120.0	61-1110.0	2	3	1	0,005
	momentary-/maintained action*	61-1330.0	61-1350.0		61-1320.0	61-1310.0	2	3	1	0,005
	MA	61-1230.0	61-1250.0	61-1240.0	61-1220.0	61-1210.0	3	3	1	0,005

switching action : momentary action = M, maintained action = MA

Accessorie front ring only requested for 24mm dia.

* convertible from momentary to maintained action

circuit drawings from page 467, technical drawings from page 457, mounting dimensions from page 462

emergency stop switch actuator foolproof, EN IEC 60947-5-5

application as per EN 60204-1 and EN 418



- 🛒 label for emergency stop switch page 450
- 🛒 switching element for emergency stop switch page 447
- 🛒 protective shroud for emergency stop switch page 450

	switching action			27 mm dia. Typ-Nr.	circuit drawing	technical drawing	mounting dimensions	
emergency stop switch actuator foolproof, EN IEC 60947-5-5 without legend plate	MA	twist to release	arrows	61-3440.4/1	4	4	2	0,038
			stop	61-3440.4/2	4	4	2	0,038
without legend plate, with green ring	MA	twist to release	arrows	61-3440.4/5	4	4	2	0,038
without legend plate standard lock 1001, other lock numbers on request	MA	key to release	stop	61-5441.4/K	4	4	2	0,038

switching action : maintained action = MA

circuit drawings from page 467, technical drawings from page 457, mounting dimensions from page 462

pushbutton actuator with mushroom-head cap



- 🛒 mushroom-head cap page 441
- 🛒 front ring page 443
- 🛒 switching element for illuminated-/pushbutton, keylock-/selector switch 2 positions page 446

	switching action	32 mm dia. Typ-Nr.	circuit drawing	technical drawing	mounting dimensions	
pushbutton actuator with mushroom-head cap	M	61-1140.0	2	5	2	0,006
	MA	61-1240.0	3	5	2	0,006

switching action : momentary action = M, maintained action = MA

circuit drawings from page 467, technical drawings from page 457, mounting dimensions from page 462

keylock switch actuator 2 positions

if installed with anti-twist device, the lug is on the left page.

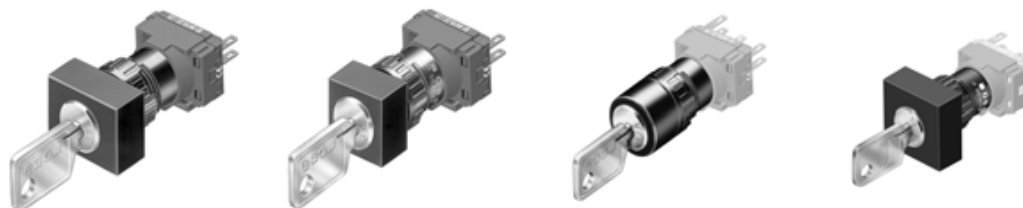

keylock front bezel page 441

switching element for illuminated-/pushbutton, keylock-/selector switch 2 positions page 446

anti-twisting ring page 450

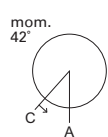
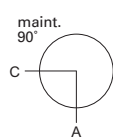

	switching action	key removable in	part no.	circuit drawing	technical drawing	mounting dimensions	
keylock switch actuator 2 positions position A: basic position position C: momentary action standard lock 311, other lock numbers on request	M	A	61-2101.0/D	5	6	1	0,065
position A: basic position position C: maintained action standard lock 311, other lock numbers on request	MA	A	61-2201.0/D	6	6	1	0,065
		C	61-2203.0/D	6	6	1	0,065
		C + A	61-2205.0/D	6	6	1	0,065

switching action : momentary action = M, maintained action = MA

circuit drawings from page 467, technical drawings from page 457, mounting dimensions from page 462

keylock switch actuator 3 positions

if installed with anti-twist device, the lug is on the left page.



🛒 keylock front bezel page 441

🛒 switching element for keylock-/selector switch 3 positions page 447

🛒 anti-twisting ring page 450

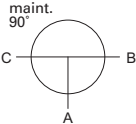
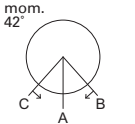
	switching action	key removable in	part no.	circuit drawing	technical drawing	mounting dimensions	
 maint. 90°							
 mom. 42°							
keylock switch actuator 3 positions position C: momentary action position A: basic position position B: momentary action standard lock 311	momentary - 0 - momentary	A	61-2501.0/D	7	6	1	0,065
position C: momentary action position A: basic position position B: maintained action standard lock 311	momentary - 0 - maintained	A	61-2801.0/D	10	6	1	0,065
		A+B	61-2804.0/D	10	6	1	0,065
		B	61-2802.0/D	11	6	1	0,065
position C: maintained action position A: basic position position B: momentary action standard lock 311, other lock numbers on request	maintained - 0 - momentary	A	61-2701.0/D	9	6	1	0,065
		C	61-2703.0/D	9	6	1	0,065
		C + A	61-2705.0/D	9	6	1	0,065
position C: maintained action position A: basic position position B: maintained action standard lock 311, other lock numbers on request	maintained - 0 - maintained	A	61-2601.0/D	8	6	1	0,065
		A+B	61-2604.0/D	8	6	1	0,065
		B	61-2602.0/D	8	6	1	0,065
		C	61-2603.0/D	8	6	1	0,065
		C + A	61-2605.0/D	8	6	1	0,065
		C+A+B	61-2607.0/D	8	6	1	0,065
C+B	61-2606.0/D	8	6	1	0,065		

switching action: momentary action = M, maintained action = MA

circuit drawings from page 467, technical drawings from page 457, mounting dimensions from page 462

selector switch actuator 2 positions

if installed with anti-twist device, the lug is on the left page.



- 🛒 lever page 441
- 🛒 filament lamp page 448
- 🛒 LED page 449
- 🛒 switching element for illuminated-/pushbutton, keylock-/selector switch 2 positions page 446
- 🛒 anti-twisting ring page 450

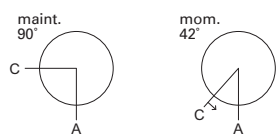

	switching action	18 mm dia. Typ-Nr.	circuit drawing	technical drawing	mounting dimensions	
selector switch actuator 2 positions position C: momentary action position A: basic position	M	61-4110.0	12	7	1	0,006
position C: maintained action position A: basic position	MA	61-4210.0	13	7	1	0,006

switching action: momentary action = M, maintained action = MA

circuit drawings from page 467, technical drawings from page 457, mounting dimensions from page 462

selector switch actuator 3 positions

if installed with anti-twist device, the lug is on the left page.



- 🛒 lever page 441
- 🛒 filament lamp page 448
- 🛒 LED page 449
- 🛒 switching element for keylock-/selector switch 3 positions page 447
- 🛒 anti-twisting ring page 450

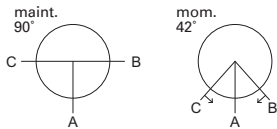

	switching action	18 mm dia. Typ-Nr.	circuit drawing	technical drawing	mounting dimensions	
selector switch actuator 3 positions position C: momentary action position A: basic position position B: momentary action	momentary - 0 - momentary	61-4510.0	14	7	1	0,006
position C: momentary action position A: basic position position B: maintained action	momentary - 0 - maintained	61-4810.0	17	7	1	0,006
position C: maintained action position A: basic position position B: momentary action	maintained - 0 - momentary	61-4710.0	16	7	1	0,006
position C: maintained action position A: basic position position B: maintained action	maintained - 0 - maintained	61-4610.0	15	7	1	0,006

switching action: momentary action = M, maintained action = MA

circuit drawings from page 467, technical drawings from page 457, mounting dimensions from page 462

indicator complete for flush mounting



- 🛒 lens plastic for flush mounting page 440
- 🛒 filament lamp page 448
- 🛒 LED page 449
- 🛒 front bezel set for indicators and illuminated pushbuttons for flush mounting page 442

	connection method	part no.	circuit drawing	technical drawing	mounting dimensions	
indicator complete for flush mounting	-	61-0000.02	1	8	3	0,006

connection method : soldering-/plug-in terminal = -
 circuit drawings from page 467, technical drawings from page 457, mounting dimensions from page 462

indicator actuator for flush mounting



- 🛒 lens plastic for flush mounting page 440
- 🛒 filament lamp page 448
- 🛒 LED page 449
- 🛒 lamp element page 445
- 🛒 diode element page 445
- 🛒 flasher element page 445
- 🛒 front bezel set for indicators and illuminated pushbuttons for flush mounting page 442

	part no.	circuit drawing	technical drawing	mounting dimensions	
indicator actuator for flush mounting	61-0009.0	1	9	3	0,005

circuit drawings from page 467, technical drawings from page 457, mounting dimensions from page 462

illuminated-/pushbutton actuator for flush mounting

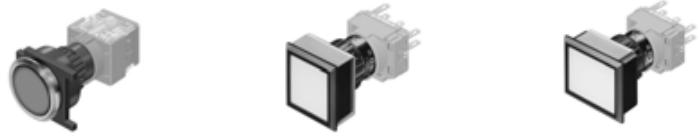

- 🛒 lens plastic for flush mounting page 440
- 🛒 lens metal with window page 441
- 🛒 lens metal page 441
- 🛒 filament lamp page 448
- 🛒 LED page 449
- 🛒 switching element for illuminated-/pushbutton, keylock-/selector switch 2 positions page 446
- 🛒 front bezel set for indicators and illuminated pushbuttons for flush mounting page 442

	switching action	part no.	circuit drawing	technical drawing	mounting dimensions	EOL
illuminated-/pushbutton actuator for flush mounting	M	61-1100.0	18	10	3	0,005
	momentary-/maintained action*	61-1300.0	19	10	3	0,005
	MA	61-1200.0	18	10	3	0,005

switching action : momentary action = M, maintained action = MA

* convertible from momentary to maintained action

circuit drawings from page 467, technical drawings from page 457, mounting dimensions from page 462

pushbutton actuator with mushroom-head cap



- 🛒 mushroom-head cap page 441
- 🛒 switching element for illuminated-/pushbutton, keylock-/selector switch 2 positions page 446
- 🛒 front bezel set for indicators and illuminated pushbuttons for flush mounting page 442

	switching action	part no.	circuit drawing	technical drawing	mounting dimensions	EOL
pushbutton actuator with mushroom-head cap	M	61-1100.0	2	11	2	0,006
	momentary-/maintained action*	61-1300.0	3	11	2	0,006
	MA	61-1200.0	2	11	2	0,006

switching action : momentary action = M, maintained action = MA

* convertible from momentary to maintained action

circuit drawings from page 467, technical drawings from page 457, mounting dimensions from page 462

keylock switch actuator with 2 positions for flush mounting



keylock front bezel page 441

switching element for illuminated-/pushbutton, keylock-/selector switch 2 positions page 446

front bezel set for keylock switch for flush mounting page 443

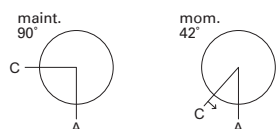

	switching action	key removable in	photo	part no.	circuit drawing	technical drawing	mounting dimensions	
keylock switch actuator with 2 positions for flush mounting position A: basic position position C: momentary action standard lock 311, other lock numbers on request	M	A		61-2101.0/D	5	12	3	0,065
position A: basic position position C: maintained action standard lock 311, other lock numbers on request	MA	A		61-2201.0/D	6	12	3	0,065
		C		61-2203.0/D	6	12	3	0,065
		C + A		61-2205.0/D	6	12	3	0,065

switching action : momentary action = M, maintained action = MA

circuit drawings from page 467, technical drawings from page 457, mounting dimensions from page 462

keylock switch actuator 3 positions for flush mounting



- 🛒 keylock front bezel page 441
- 🛒 switching element for keylock-/selector switch 3 positions page 447
- 🛒 front bezel set for keylock switch for flush mounting page 443

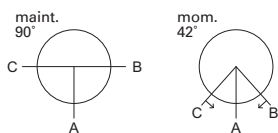

	switching action	key removable in	part no.	circuit drawing	technical drawing	mounting dimensions	
keylock switch actuator 3 positions for flush mounting position C: momentary action position A: basic position position B: momentary action standard lock 311 other lock numbers on request	momentary - 0 - momentary	A	61-2501.0/D	7	12	3	0,065
position C: momentary action position A: basic position position B: maintained action standard lock 311 other lock numbers on request	momentary - 0 - maintained	A	61-2801.0/D	10	12	3	0,065
		A+B	61-2804.0/D	10	12	3	0,065
		B	61-2802.0/D	10	12	3	0,065
position C: maintained action position A: basic position position B: momentary action standard lock 311, other lock numbers on request	maintained - 0 - momentary	A	61-2701.0/D	9	12	3	0,065
		C	61-2703.0/D	5	12	3	0,065
		C + A	61-2705.0/D	9	12	3	0,065
position C: maintained action position A: basic position position B: maintained action standard lock 311, other lock numbers on request	maintained - 0 - maintained	A	61-2601.0/D	8	12	3	0,065
		A+B	61-2604.0/D	8	12	3	0,065
		B	61-2602.0/D	8	12	3	0,065
		C	61-2603.0/D	8	12	3	0,065
		C + A	61-2605.0/D	8	12	3	0,065
		C+A+B	61-2607.0/D	8	12	3	0,065
		C+B	61-2606.0/D	8	12	3	0,065

switching action: momentary action = M, maintained action = MA

circuit drawings from page 467, technical drawings from page 457, mounting dimensions from page 462

selector switch actuator 2 positions for flush mounting



- 🛒 lever for flush mounting page 442
- 🛒 filament lamp page 448
- 🛒 LED page 449
- 🛒 switching element for illuminated-/pushbutton, keylock-/selector switch 2 positions page 446
- 🛒 front bezel set for selector switch for flush mounting page 443

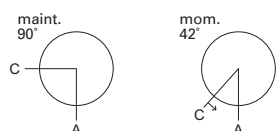

	switching action	part no.	circuit drawing	technical drawing	mounting dimensions	
selector switch actuator 2 positions for flush mounting position C: momentary action position A: basic position	M	61-4110.0	12	13	3	0,006
position C: maintained action position A: basic position	MA	61-4210.0	13	13	3	0,006

switching action : momentary action = M, maintained action = MA
 circuit drawings from page 467, technical drawings from page 457, mounting dimensions from page 462

selector switch actuator 3 positions for flush mounting



- 🛒 lever for flush mounting page 442
- 🛒 filament lamp page 448
- 🛒 LED page 449
- 🛒 switching element for keylock-/selector switch 3 positions page 447
- 🛒 front bezel set for selector switch for flush mounting page 443

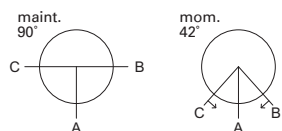

	switching action	part no.	circuit drawing	technical drawing	mounting dimensions	
selector switch actuator 3 positions for flush mounting position C: momentary action position A: basic position position B: momentary action	momentary - 0 - momentary	61-4510.0	14	13	3	0,006
position C: momentary action position A: basic position position B: maintained action	momentary - 0 - maintained	61-4810.0	17	13	3	0,006

Continued on next page

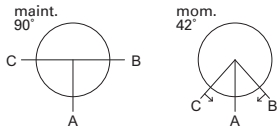

	switching action	part no.	circuit drawing	technical drawing	mounting dimensions	
selector switch actuator 3 positions for flush mounting position C: maintained action position A: basic position position B: momentary action	maintained - 0 - momentary	61-4710.0	16	13	3	0,006
position C: maintained action position A: basic position position B: maintained action	maintained - 0 - maintained	61-4610.0	15	13	3	0,006

switching action: momentary action = M, maintained action = MA

circuit drawings from page 467, technical drawings from page 457, mounting dimensions from page 462

at front

lens plastic matt

	shape	lens/sup- port	colour	⌀ for devices 24 x 24 mm Typ-Nr.	⌀ for devices 18 mm Typ-Nr.	⌀ for devices 18 x 24 mm Typ-Nr.	⌀ for devices 25 mm Typ-Nr.	⌀ for devices 18 x 18 mm Typ-Nr.				
lens plastic matt	flat	transpa- rent/ translu- cent	blue				61-9642.6		0,002			
				61-9351.6	61-9311.6	61-9331.6		61-9321.6	0,001			
			colour- less, clear					61-9642.7			0,002	
				61-9351.7	61-9311.7	61-9331.7			61-9321.7	0,001		
			yellow							61-9321.4	0,001	
				61-9351.4	61-9311.4	61-9331.4					0,002	
			green						61-9642.4		0,002	
				61-9351.5	61-9311.5	61-9331.5				61-9321.5	0,001	
			orange								61-9642.5	0,002
				61-9351.3	61-9311.3	61-9331.3				61-9321.3	0,001	
			smoked								61-9642.3	0,002
				61-9351.1	61-9311.1	61-9331.1					61-9642.1	0,002
			red								61-9321.1	0,001
				61-9351.2	61-9311.2	61-9331.2					61-9321.2	0,001
									61-9642.2		0,002	
(not for film insert and illumination)	concave	transpa- rent/ translu- cent	blue			61-9336.6		61-9326.6	0,001			
				61-9336.7				61-9326.7	0,001			
			colour- less, clear					61-9336.4		61-9326.4	0,001	
				61-9336.5					61-9326.5	0,001		
			yellow					61-9336.3		61-9326.3	0,001	
				61-9336.2					61-9326.2	0,001		
red							61-9221.8	0,001				
	61-9251.8	61-9211.8	61-9231.8				61-9221.8	0,001				
(not for film insert and illumination)	concave	opaque/ translu- cent	black			61-9231.0		61-9221.0	0,001			
				61-9251.0	61-9211.0							
(not for film insert and LED)	flat	opaque/ translu- cent	grey			61-9236.8		61-9226.8	0,001			
				61-9236.0				61-9226.0	0,001			
(not for film insert and LED)	concave	opaque/ translu- cent	black					61-9226.8	0,001			
				61-9236.0				61-9226.0	0,001			
(not for film insert and LED)	flat	translu- cent/ translu- cent	white			61-9231.9		61-9221.9	0,001			
				61-9251.9	61-9211.9							
(not for film insert and LED)	concave	translu- cent/ translu- cent	white			61-9236.9		61-9226.9	0,001			
				61-9236.9				61-9226.9	0,001			



lens plastic for flush mounting

	shape	lens/support	colour	⌀ for devices 24 x 30 mm Typ-Nr.	⌀ for devices 25 mm Typ-Nr.	⌀ for devices 24 x 24 mm Typ-Nr.	
lens plastic for flush mounting matt	flat	transparent/translucent	blue	61-9681.6	61-9642.6	61-9671.6	0,001
			colourless, clear	61-9681.7	61-9642.7	61-9671.7	0,001
			yellow	61-9681.4	61-9642.4	61-9671.4	0,001
			green	61-9681.5	61-9642.5	61-9671.5	0,001
			orange	61-9681.3	61-9642.3	61-9671.3	0,001
			smoked	61-9681.1	61-9642.1	61-9671.1	0,001
			red	61-9681.2	61-9642.2	61-9671.2	0,001
matt (not for film insert and illumination)	flat	opaque/translucent	grey	61-9781.8		61-9771.8	0,001
			black	61-9781.0		61-9771.0	0,001
matt (not for film insert and LED)	flat	translucent/translucent	white	61-9781.9		61-9771.9	0,001



lens metal with window

	shape	lens	colour	25 mm dia. Typ-Nr.	
lens metal with window matt	flat	aluminium anodized	natural	61-9841.8A	0,002



lens metal

	shape	lens	colour	25 mm dia. Typ-Nr.	
lens metal matt	flat	aluminium anodized	blue	61-9841.6	0,002
			yellow	61-9841.4	0,002
			green	61-9841.5	0,002
			natural	61-9841.8	0,002
			red	61-9841.2	0,002
			black	61-9841.0	0,002







mushroom-head cap

	mushroom	colour	32 mm dia. Typ-Nr.	
mushroom-head cap plastic	opaque	yellow	61-9593.4	0,004
		green	61-9593.5	0,004
		red	61-9593.2	0,004
		black	61-9593.0	0,004



keylock front bezel

for keylock switch actuator

	 18 x 24 mm Typ-Nr.	 18 x 18 mm Typ-Nr.	18 mm dia. Typ-Nr.	 24 x 24 mm Typ-Nr.	
keylock front bezel for standard mounting	61-9130.0	61-9120.0	61-9110.0	61-9250.0	0,001
for flush mounting	61-9230.0	61-9220.0	61-9210.0		0,001



lever

	colour	colour of bar	part no.	
lever with marking dot and transparent bar	grey	blue	52-929.60	0,001
		yellow	52-929.40	0,001
		grey	52-929.8	0,001
		green	52-929.50	0,001
		orange	52-929.30	0,001
		red	52-929.20	0,001
		white	52-929.9	0,001
		black	blue	52-928.60
	yellow		52-928.40	0,001
	green		52-928.50	0,001
	orange		52-928.30	0,001
	red		52-928.20	0,001
	black		52-928.0	0,001
	white, translucent		52-928.9	0,001



lever for flush mounting

	colour	colour of bar	part no.	
lever for flush mounting with marking dot and transparent bar	grey	blue	61-9029.60	0,001
		yellow	61-9029.40	0,001
		grey	61-9029.8	0,001
		green	61-9029.50	0,001
		orange	61-9029.30	0,001
		red	61-9029.20	0,001
		white	61-9029.9	0,001
	black	blue	61-9028.60	0,001
		yellow	61-9028.40	0,001
		green	61-9028.50	0,001
		orange	61-9028.30	0,001
		red	61-9028.20	0,001
		black	61-9028.0	0,001
		white, opaque	61-9028.9	0,001



marking plate

for lens round, 61-9642...

	front shape	marking plate	colour	part no.	
marking plate clear, of plastic, can be hot pressed	round	transparent	clear	61-9707.7	0,001



legend plate

	front dimension	part no.	
legend plate adhesive, aluminium anodized, natural, can also be engraved	30 x 42 mm for 22.5 mm dia. mounting hole	704.962.0	0,002
	42 x 42 mm for 22.5 mm dia. mounting hole	704.962.5	0,003



front bezel

for selector switch square front

	material	colour	∅ 24 x 24 mm Typ-Nr.	∅ 26 x 26 mm Typ-Nr.	
front bezel	plastic	black	52-950.0	52-952.0	0,001



front bezel set for indicators and illuminated pushbuttons for flush mounting

	material	colour	∅ 24 x 30 mm Typ-Nr.	∅ 24 x 24 mm Typ-Nr.	25 mm dia. Typ-Nr.	
front bezel set for indicators and illuminated pushbuttons for flush mounting	aluminium	natural anodized			61-9933.0	0,006
		black anodized			61-9933.1	0,006
	plastic	black	61-9931.0	61-9930.0	61-9933.10	0,008



front bezel set for keylock switch for flush mounting

	material	colour	⌀ 24 x 30 mm Typ-Nr.	⌀ 24 x 24 mm Typ-Nr.	25 mm dia. Typ-Nr.	
front bezel set for keylock switch for flush mounting	aluminium	natural anodized			61-9932.0	0,006
		black anodized			61-9932.1	0,006
	plastic	black	61-9931.0	61-9930.0	61-9932.10	0,008



front bezel set for selector switch for flush mounting

	material	colour	⌀ 24 x 24 mm Typ-Nr.	20 mm dia. Typ-Nr.	
front bezel set for selector switch for flush mounting	aluminium	natural anodized		61-9932.0	0,006
		black anodized		61-9932.1	0,006
	plastic	black	61-9936.0	61-9932.10	0,007



front ring

for actuator 24 mm dia.

	material	colour	part no.	
front ring	aluminium anodized	natural	61-9600.1	0,003
		black	61-9600.0	0,003



protective front membrane cap

for actuator 24 mm dia.

	material	colour	part no.	
protective front membrane cap for front bezel-set	silicone natural	transparent	84-9103.7	0,001
for front bezel set round, for standard fitting	silicone natural	transparent	61-9926.7	0,001



protective cover

	⌀ 18 x 24 mm Typ-Nr.	⌀ 18 x 18 mm Typ-Nr.	⌀ 24 x 24 mm Typ-Nr.	technical drawing	
protective cover hinged, transparent, with means for sealing		51-920		14	0,005
	51-925			15	0,005
			61-9920.0	16	0,006



technical drawings from page 457

protective cover for flush mounting

	□ 24 x 30 mm Typ-Nr.	□ 24 x 24 mm Typ-Nr.	25 mm dia. part no. Typ-Nr.	kg
protective cover for flush mounting slide be side, transparent, with means not for sealing			61-9924.0	0,006
hinged, transparent, with means for sealing	61-9922.0	61-9921.0		0,006

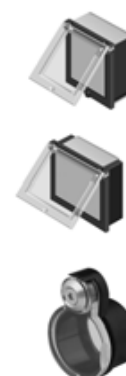

blind plug projecting

	colour	□ 18 x 24 mm Typ-Nr.	□ 18 x 18 mm Typ-Nr.	18 mm dia. Typ-Nr.	□ 24 x 24 mm Typ-Nr.	mounting dimensions	kg
blind plug projecting for mounting hole 16 mm dia.	black	51-947.0	51-948.0	51-949.0	61-9450.0	1	0,003



mounting dimensions from page 462

blind plug flat

	colour	□ 24 x 30 mm Typ-Nr.	□ 24 x 24 mm Typ-Nr.	28 mm dia. Typ-Nr.	mounting dimensions	kg
blind plug flat for mounting hole 21 x 21 mm	black		61-9451.0		3	0,006
for mounting hole 21 x 27 mm	black	61-9452.0			3	0,006
for mounting hole 22.5 mm dia.	black			704.960.7	3	0,006



mounting dimensions from page 462

master key

	part no.	kg
master key for lock numbers 311-445	31-989.300	0,006



spare key

	part no.	kg
spare key for emergency stop switch with key to release, lock type KABA standard lock 1001, other lock numbers on request	14-987.1001	0,006
for keylock switch, lock type DOM standard lock 311, other lock numbers on request	31-989.311	0,006



EMC key protection cap

	part no.	
EMC key protection cap plastic black, for lock type DOM	31-985.0	0,005



at back

lamp element

	part no.	circuit drawing	
lamp element with soldering terminal	61-8006.02	1	0,005
with screw terminal	61-8006.01	1	0,005



plug-in connection only up to 48 V
circuit drawings from page 467

diode element

	number of diodes	part no.	circuit drawing	component layout	
diode element with soldering terminal	1	61-8101.02	20	1	0,007
	2	61-8102.02	21	2	0,008



circuit drawings from page 467, component layouts from page 463

flasher element

	operation voltage	connection method	part no.	
flasher element	12 VAC/DC - 28 VAC/DC	S	61-8000.05	



switching element for illuminated-/pushbutton, keylock-/selector switch 2 positions

	diode (1N 4007)	switching system	contacts	connection method	material of contacts	part no.	circuit drawing	component layout	kg		
switching element for illuminated-/pushbutton, keylock-/selector switch 2 positions with lamp connection, switching capacity min. 50,000 operations at 250 VAC / 5 A cos ϕ = 0.95	-	SA	1 NO	-	gold/silver	61-8410.22	22	3	0,007		
					silver	61-8410.12	22	3	0,007		
			1 NC	-	gold/silver	61-8440.22	25	8	0,007		
					silver	61-8440.12	25	8	0,007		
			1 NC + 1 NO	-	gold/silver	61-8470.22	33	13	0,007		
					silver	61-8470.12	33	13	0,007		
			1 NC + 2 NO	-	gold/silver	61-8490.22	35	16	0,007		
					silver	61-8490.12	35	16	0,007		
			2 NO	-	gold/silver	61-8420.22	23	4	0,007		
					silver	61-8420.12	23		0,007		
		2 NC	-	gold/silver	61-8450.22	27	10	0,007			
				silver	61-8450.12	27	10	0,007			
		2 NC + 1 NO	-	gold/silver	61-8480.22	34	15	0,007			
				silver	61-8480.12	34	15	0,007			
		3 NO	-	gold/silver	61-8430.22	24	7	0,007			
				silver	61-8430.12	24	7	0,007			
		3 NC	-	gold/silver	61-8460.22	32	12	0,007			
				silver	61-8460.12	32	12	0,007			
		T	-	SA	1 NO	-	silver	61-8610.17	22	5	0,008
					1 NC	-	silver	61-8640.17	25	9	0,008
1 NC + 1 NO	-				silver	61-8670.17	33	14	0,008		
2 NO	-				silver	61-8620.17	23		0,008		
2 NC	-				silver	61-8650.17	27		0,008		
2 SA	-	SA	1 NO + 2	-	gold/silver	61-8212.22	36	17	0,007		
					silver	61-8212.12	36	17	0,007		
with lamp connection, for use for low level switching max. 42 VAC/DC, max. 100 mA	-	T	1 NO	-	gold	61-8610.37	22	5	0,008		
			1 NC	-	gold	61-8640.37	25	9	0,008		
			1 NC + 1 NO	-	gold	61-8670.37	33	14	0,008		
			2 NO	-	gold	61-8620.37	23	6	0,008		
			2 NC	-	gold	61-8650.37	27	11	0,008		
with lamp terminal, max. 250 VAC/6A	-	T	1 NO	ST	silver	61-8610.11	22	4	0,008		
			1 NC	ST	silver	61-8640.11	26		0,008		
without lamp connection, switching capacity min. 50,000 alternations at 250 VAC / 6 A cos ϕ = 0.95	-	T	1 NO	ST	silver	61-8615.11	28		0,008		
			1 NC	ST	silver	61-8645.11	26		0,008		
			1 NC + 1 NO	ST	silver	61-8675.11	31		0,008		
			2 NO	ST	silver	61-8625.11	29		0,008		
			2 NC	ST	silver	61-8655.11	30		0,008		

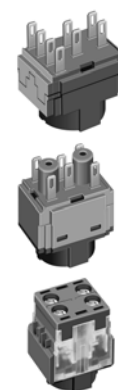

switching system : snap-action switching element = SA, slow-make switching element = T

contacts : 1 normally open = 1 NO, 1 normally closed = 1 NC, normally closed = NC

connection method : soldering-/plug-in terminal = -, screw terminal = ST

We offer a dismantling tool Art. no. 61-9711.0 for the dismantling of the switching element.

circuit drawings from page 467, component layouts from page 463

switching element for emergency stop switch

	switching system	contacts	connection method	material of contacts	part no.	circuit drawing	component layout	
switching element for emergency stop switch switch rating AC-15 250 VAC / 2 A DC-13 250 VDC / 0.2 A	T	1 NC	ST	silver	61-8745.11	39		0,008
		1 NC + 1 NO	ST	silver	61-8775.11	38		0,008
		2 NC	ST	silver	61-8755.11	37		0,008
switch rating AC-15 250 VAC / 2 A DC-13 250 VDC / 0.15 A	T	1 NC	-	silver	61-8745.17	39	18	0,008
		1 NC + 1 NO	-	silver	61-8775.17	38	20	0,008
		2 NC	-	silver	61-8755.17	37	19	0,008
for use for low level switching max. 42 VAC/DC, max. 100 mA	T	1 NC	-	gold	61-8745.37	39	18	0,008
		1 NC + 1 NO	-	gold	61-8775.37	38	20	0,008
		2 NC	-	gold	61-8755.37	37	19	0,008

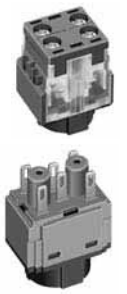

switching system : T = slow-make switching element
 contacts : NC = normally closed, NO = normally open, 1 NC = 1 normally closed
 connection method : ST = screw terminal, - = soldering-/plug-in terminal
 General specifications for switching element for emergency button: if not otherwise stated, certified according to EN 60947-5-5
 further specifications in the technical data
 circuit drawings from page 467, component layouts from page 463

switching element for keylock-/selector switch 3 positions

	switching system	contacts	connection method	material of contacts	part no.	circuit drawing	component layout	
switching element for keylock-/selector switch 3 positions with lamp connection, switching power min. 50,000 alterna- tions at 250 VAC / 5 A cos ϕ = 0.95	SA	1 NC + 1 NO	-	gold/silver	61-8574.22	33	22	0,008
				silver	61-8574.12	33	22	0,008
		2 NO	-	gold/silver	61-8520.22	23	18	0,008
				silver	61-8520.12	23	18	0,008
		2 NC	-	gold/silver	61-8550.22	27	20	0,008
				silver	61-8550.12	27	20	0,008
with lamp connection, for use for low level switching C181max. 42 VAC/DC, max. 100 mA	T	1 NC + 1 NO	-	silver	61-8770.17	33	23	0,008
		2 NO	-	silver	61-8720.17	23	19	0,008
		2 NC	-	silver	61-8750.17	27	21	0,008
without lamp connection, switching power min. 50,000 alterna- tions at 250 VAC / 5 A cos ϕ = 0.95	T	1 NC + 1 NO	ST	silver	61-8775.11	33		0,008
		2 NO	ST	silver	61-8725.11	23		0,008
		2 NC	ST	silver	61-8755.11	30		0,008



switching system : SA = snap-action switching element, T = slow-make switching element
 contacts : NC = normally closed, NO = normally open, 1 NC = 1 normally closed
 connection method : ST = screw terminal, - = soldering-/plug-in terminal
 General specifications for switching element: if not otherwise stated, certified according to EN 61058-1 and EN 60947-5-1
 further specifications in the technical data
 circuit drawings from page 467, component layouts from page 463

PCB plug-in base

for plug-in terminal

	for	pin orientation	part no.	component layout	
PCB plug-in base 15 mm x 23 mm x 9.4 mm	slow-make switching element	axial	61-9823	29	0,002
17.7 mm x 23.6 mm x 10.9 mm	snap-action switching element	axial	61-9821.1	28	0,003
13.1 mm dia. x 12.8 mm	indicator complete	axial	61-9820.1	27	0,002



component layouts from page 463

multi-plug housing

	part no.	
multi-plug housing for snap-action switching element, max. 6 connections possible	61-9830	0,002



cable shoe

	connection method	part no.	
cable shoe	plug-in terminal 2.8 x 0.5 mm	31-946	0,001
	plug-in terminal 2.8 x 0.5 mm for multi-plug housing	51-943.1	0,001



terminal cover

	use	part no.	
terminal cover	for indicator element	61-9831.2	0,001
	for snap-action switching element	61-9830.2	0,002

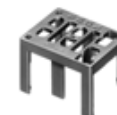

for illumination

Filament lamp

	voltage/current	part no.	
Filament lamp base MG T 1 3/4	6.0 VAC/VDC/125 mA	10-1306.1349	0,001
	6.3 VAC/VDC/200 mA	10-1307.1369	0,001
	12 VAC/VDC/75 mA	10-1309.1309	0,001
	14 VAC/VDC/80 mA	10-1310.1319	0,001
	18 VAC/VDC/40 mA	10-1311.1249	0,001
	24 VAC/VDC/35 mA	10-1312.1229	0,001
	28 VAC/VDC/30 mA	10-1313.1209	0,001
	28 VAC/VDC/40 mA	10-1313.1249	0,001
	36 VAC/VDC/20 mA	10-1316.1179	0,001
	36 VAC/VDC/30 mA	10-1316.1209	0,001
	48 VAC/VDC/20 mA	10-1319.1179	0,001
	48 VAC/VDC/25 mA	10-1319.1199	0,001



LED

	number of chips	voltage/current	colour	part no.	
LED base MG T 1 3/4	1 chip	24 VDC/14 mA	white	10-2312.3139	0,001
		28 VDC/14 mA	white	10-2313.3139	0,001
<p>Note: For optimal illumination we strongly recommend using our new single-chip LEDs.</p> <p>For new designs, only the new single-chip LEDs should be chosen. They can be found on page 669.</p>	6 chips	6 VDC/45 mA	yellow	10-5306.3254	0,001
			green	10-5306.3255	0,001
			red	10-5306.3252	0,001
		12 VDC/30 mA	yellow	10-5309.3204	0,001
			green	10-5309.3205	0,001
			red	10-5309.3202	0,001
		24 VAC/DC/12.5 mA	yellow	10-5312.1114	0,001
			green	10-5312.1115	0,001
			red	10-5312.1112	0,001
	24 VDC/14 mA	yellow	10-5312.3134	0,001	
		green	10-5312.3135	0,001	
		red	10-5312.3132	0,001	
	28 VAC/DC/12.5 mA	yellow	10-5313.1114	0,001	
		green	10-5313.1115	0,001	
		red	10-5313.1112	0,001	
	28 VDC/14 mA	yellow	10-5313.3134	0,001	
		green	10-5313.3135	0,001	
		red	10-5313.3132	0,001	
	48 VDC/12 mA	yellow	10-5319.3104	0,001	
		green	10-5319.3105	0,001	
		red	10-5319.3102	0,001	
	8 chips	6 VDC/48 mA	yellow	10-6306.3264	0,001
			green	10-6306.3265	0,001
			red	10-6306.3262	0,001
12 VDC/24 mA		yellow	10-6309.3184	0,001	
		green	10-6309.3185	0,001	
		red	10-6309.3182	0,001	
24 VDC/12 mA		yellow	10-6312.3104	0,001	
		green	10-6312.3105	0,001	
		red	10-6312.3102	0,001	
28 VDC/12 mA		yellow	10-6313.3104	0,001	
		green	10-6313.3105	0,001	
		red	10-6313.3102	0,001	



capacitor

for lamp voltage reduction from 230 VAC (50 Hz) to 48 V

	value	part no.	
capacitor for filament lamp 48 VAC / 20 mA (only usable for this type of lamp!)	0.27 µF	02-917.0	0,004



Please keep to the country specific security rules.

capacitor

	value	part no.	
capacitor use with 48 V/25 mA	0,33 µF	700.003.0	0,004



Wire in accordance with local electrical safety regulations.

terminal plate empty

for fitting with series resistors and capacitors

	no. of spaces	part no.	
terminal plate empty	5 spaces	02-912.1	0,025
	10 spaces	02-912.2	0,045
	15 spaces	02-912.3	0,090
	20 spaces	02-912.4	0,095



terminal plate with capacitor

for lamp voltage reduction from 230 VAC (50 Hz) to 48 VAC

	value	no. of components	part no.	
terminal plate with capacitor for filament lamp 48 VAC / 20 mA	0.27 µF	5 spaces	02-914.10	0,045
		10 spaces	02-914.20	0,090
		15 spaces	02-914.30	0,135
		20 spaces	02-914.40	0,180



for emergency stop switch

label for emergency stop switch

	marking	43 mm dia. Typ-Nr.	
label for emergency stop switch 43 mm dia., yellow	ARRET D'URGENCE	61-9970.3	0,002
	Emergency Stop	61-9970.2	0,002
	emergency stop	61-9970.1	0,002
	without marking	61-9970.0	0,002



protective shroud for emergency stop switch

	part no.	
protective shroud for emergency stop switch Aluminium anodized, yellow varnished	61-9965	



enclosure for emergency stop switch

	part no.	
enclosure for emergency stop switch with mounting hole size 16 mm dia. colour RAL 1004. dimensions: 65 mm long, 65 mm wide, 57 mm high front protection IP 65	61-9480.4	0,079

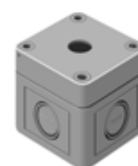

cable gland M16

	part no.	
cable gland M16	61-9481.8	0,005



assembling

anti-twisting ring

	part no.	
anti-twisting ring for key- and selector switch	51-910	0,002



reducing ring

for 16 mm pushbuttons in mounting hole 22.5 mm dia.

	part no.	
reducing ring only for use of front dimension: 24 x 24 mm/24 mm dia.	61-9960	0,003



tool-set

	part no.	
tool-set consists of lens remover, lamp remover, mounting tool, dismantling tool	K61-999.100	



lens remover

	use	part no.	
lens remover	for 24 x 24 mm, 25 mm dia. front and overhanging lenses	61-9730.0	0,011
	for standard lenses	02-905	0,011



lamp/LED remover

	part no.	
lamp/LED remover ATTENTION A switching process might be released when replacing the lamp/LED!	61-9740.0	0,003



dismantling tool for switching element

	part no.	
dismantling tool for switching element	61-9711.0	0,004



mounting tool

	part no.	
mounting tool for tightening (or loosening) fixing nuts	01-907	0,020



cable shoe remover

	part no.	
cable shoe remover for removing the connector from the multi-plug housing	51-943.9	0,001



dismantling tool

	part no.	
dismantling tool for lens, lens holder and switching element block	51-938	0,027



actuator with snap-action switching element

switching system

switching system

Self-cleaning, double-break snap-action switching system with contact opening width 2 x 0.5 mm (= switch with small contact opening width as per EN/IEC 61058-1 section 7.1.11!).

The switching elements are optionally equipped with the following switching functions

1 to 3 NO or NC, or any combination of NO and NC, but the number of switching elements cannot exceed 3.

The switching elements provided for the 3-position actuators are equipped with 1 or 2 NC, 1 or 2 NO, or with 1 NO and 1 NC (therefore the number of switching elements cannot exceed 2)

material

lenses

Polymethyl methacrylate (PMMA), polycarbonate (PC) or aluminium (anodized)

front bezel

polyetherimide PEI and chromium plated

front ring

Aluminium anodized

material of contacts

Silver or silver with gold plating

switching element

diallyl phthalate (DAP) and polyamide 66 (PA 66)

actuator case

Polyether imide (PEI) self-extinguishing

mechanical characteristics

connection method

Solder lugs (cross-section 2.8 x 0.5 mm)
for connection of wire \geq 1.5 mm or flex 1.5 mm

These solder lugs may be connected by means of spade terminal sockets 2.8 x 0.5 mm, if switching is operated to a safety low-voltage.

actuating torque

with selector or key switches (with snap-action switching elements):
2.5-10 N cm,
depending on switching element component

actuating force

with pushbuttons (with snap-action switching elements) 2.7-3.6 N,
depending on switching element component

actuating travel

illuminated pushbutton: 3 mm

2-position selector or key switch:
momentary action design approx. 42°
maintained action design approx. 90°
3-position selector or key switch:
momentary action design approx. 2 x 42°
maintained action design approx. 2 x 90°

switch actuator with 3 positions:
2 x ca. 42° deflection momentary action
2 x ca. 90° deflection maintained action

storage temperature

Permitted range of ambient temperature for storage or transport -40°C to +85°C

mechanical life

as per IEC 512-5-6
momentary action 2 million cycles of operation
maintained action 1 million cycles of operation
keylock switch 50'000 cycles of operation
selector switch 100'000 cycles of operation

rebound time

on closing the contact = 3 ms
on opening the contact = 5 ms
testing based on DIN 41640 Part 85, draft 87 (no valid successor document). The rebound times apply to normal manual activation.

resistance to shock

semi-sinusoidal signal impacts with peak acceleration 50 g and surge width 11 ms (tested as per IEC 60068-2-27).

degree of protection

(penetration of water or foreign bodies)
actuators front side IP 65
switching elements attached to actuator IP40
(without taking into consideration the contactability of the connections)

resistance to vibration

with sinusoidal dynamic load 10 Hz to 58 Hz, amplitude of oscillation 0.75 mm, 58 Hz to 2000 Hz, peak value of the acceleration 10 g (tested as per IEC 60068-2-6).

ambient air temperature

-25°C to + 55°C

As "ambient temperature in operation" is firstly the temperature of the air in the interior of the device, secondly the temperature of the air on the front exterior of the device and thirdly the temperature of the operation panel in which the switches are situated

electrical characteristics

rated voltage

250 VAC/VDC

rated current

6 A

contact resistance

with snap-action switching elements in new state
silver contact: as per IEC 60512-2-4, Test 2b, measured at 10 or 100 mA, 20 V
gold plated contact+C204: as per IEC 60512-2-3, Test 2a, measured at 20 mV, 10 mA = 50 mΩ

electrostatic breakdown value

\geq 11 KV (keylock switch)

continuous thermal current I_{th2}

5 A

The maximum current in continuous operation and at ambient temperature not exceeding the quoted maximum values.

switch rating

of the snap-action switching element with silver contacts or silver contacts with gold plating (as per EN/IEC 60947-5-1)
service category rated operating voltage (as per EN/IEC 60947-5-1, 4-3.3.1)

rated operating current (as per EN/IEC 60947-5-1, 4.3.2.3)

AC-15	250 VAC	2 A
DC-13	125 VDC	0.15 A

Recommended minimum operational data for snap-action switching element with silver contacts
operating voltage operating current
20 VAC/VDC 100 mA

Recommended minimum operational data for snap-action switching element with gold plated silver contacts

switch rating AC, cos. ϕ 0.7:

rated service voltage	250 VAC	125 VAC	110 VAC
rated service current	2 A	3 A	3 A

switch rating DC, L:R=30 ms:

rated service voltage:	220 VDC	110 VDC	60 VDC	24 VDC
rated service current resistive:	0.5 A	0.7 A	2.0 A	6.0 A
rated service current L:R=30ms:	0.15 A	0.3 A	0.7 A	2.0 A

switch rating DC, L:R=30 ms:
rated service voltage:
rated service current resistive:
rated service current L:R=30ms:

protection class

II

electric strength

as per VDE 0630 (IEC 512-2-11)

2500 VAC, 50 Hz, 1 min between all terminals and earth

rules

rules

IEC 1058 EN 61 058

approvals

approvals

- CE (declaration of conformity)
- CSA 300 VAC
- ENEC
- UL
- German Lloyd
- CB
- VDE

actuator with slow-make switching element

switching system

switching system

double-break slow-make system, contact opening width 2 x 1.5 mm, with 2 x 2 contact points per switching element .
NC - contact elements in the slow-make elements fulfill requirements of switches with forced opening as per EN/IEC 60947-5-1, section

The slow-make elements are optionally obtainable with the following switching functions:

1 or 2 NO or NC, or 1 NO and 1 NC.

material

lenses

polymethyl methacrylate (PMMA), polycarbonate (PC) or aluminium

front bezel

made of polyether imide PEI

front ring

Aluminium anodized

material of contacts

silver, gold (specified for operation for low level switching)

slow-make elements with gold contacts do not have certification documents.

switching element

diallyl phthalate (DAP) and polyamide 66 (PA 66)

actuator case

polyetherimide PEI, self-extinguishing

mechanical characteristics

connection method

solder lugs (cross-section 2.8 x 0.5 mm)
for max. 2 individual wires with 1 mm

These solder lugs may be connected by means of spade terminal sockets 2.8 x 0.5 mm, if switching is operated to a safety low-voltage.

screw terminals

for flex 1 mm

or for single wire \varnothing 1.2 mm

actuating torque

with selector or key switches 4-16 N cm depending on the switching element component

actuating force

with pushbuttons (with slow-make elements) 3.5-11 N depending on the switching element component
with emergency button max. 65 N

actuating travel

illuminated pushbutton: 3 mm

2-position selector or key switch

momentary design approx. 42°

maintained design approx. 90°

3-position selector or key switch

momentary action design approx. 2 x 42°

maintained action design approx. 2 x 90°

emergency buttons 10 mm

switch actuator with 3 positions:

2 x ca. 42° deflection momentary action

2 x ca. 90° deflection maintained action

storage temperature

-40°C +85°C permitted range of ambient temperature for storage or transport

ambient air temperature

-25°C to +55°C As "ambient temperature in operation" is firstly the temperature of the air in the interior of the device, secondly the temperature of the air on the front exterior of the device and thirdly (as per DIN IEC 68-)

mechanical life

as per IEC 512-5-6

momentary action	2 million cycles of operation
maintained action	1 million cycles of operation
keylock switch	50'000 cycles of operation
selector switch	100'000 cycles of operation
emergency stop switch	50'000 cycles of operation

rebound time

on closing the contact = 2 ms
on opening the contact = 2 ms
testing based on DIN 41640 Part 85, draft 87 (no valid successor document) The rebound times apply to normal manual activation.

resistance to shock

semi-sinusoidal signal impacts with peak acceleration 50 g and surge width 11 ms (tested as per IEC 60068-2-27)

degree of protection

(penetration of water or foreign bodies)
actuators front side IP 65
switching elements attached to actuator IP40
(without taking into consideration the contactability of the connections)

resistance to vibration

with sinusoidal dynamic load 10 Hz to 58 Hz, amplitude of oscillation 0.75 mm, 58 Hz to 2000 Hz, peak value of the acceleration 10 g (tested as per IEC 60068-2-6)

degree of pollution

3

electrical characteristics

rated voltage

rated insulation voltage U_i (as per EN/IEC 60947-5-1, 4.3.1.2) 320 VAC
rated operating voltage U_e (as per EN/IEC 60947-5-1, 4.3.3.1) = 250 VAC/VDC

rated current

6 A

contact resistance

starting value (initial) for:
gold-/silver contact $\leq 50 \text{ m}\Omega$ as per IEC 512-2-test 4
silver contact $\leq 100 \text{ m}\Omega$ as per IEC 512-2-test 5

electrostatic breakdown value

$\geq 11 \text{ KV}$ (keylock switch)

electrical life

switching element of emergency stop switch 6050 cycles of operation

continuous thermal current I_{th2}

(as per EN/IEC 60947-5-1, 4.3.2.1)
slow-make element with soldering terminal and silver contacts 5 A
slow-make element with screw terminal and silver contacts 6 A

max. permissible rated current

max. series fuse to be provided 10 A gL

switch rating

with silver contacts & soldering terminal (as per EN/IEC 60947-5-1)
service category rated operating voltage rated operating current (as per EN/IEC 60947-5-1, 4.3.3.1) (as per EN/IEC 60947-5-1, 4.3.2.3)

AC-15	250 VAC	2 A
DC-13	250 VDC	0.1

with silver contacts and screw terminal (as per EN/IEC 60947-5-1)
service category rated operating voltage rated operating current (as per EN/IEC 60947-5-1, 4.3.3.1) (as per EN/IEC 60947-5-1, 4.3.2.3)

AC-15	250 VAC	2 A
DC-13	250 VDC	

recommended minimum operational data for slow-make elements with silver contacts

operating voltage operating current
20 VAC/VDC 100 mA

volume resistivity for slow-make elements with silver contacts (new state)

as per IEC 60512-2-4, Test 2b, at 10 or 100 mA, 20 V = 50 m Ω

electrical characteristic values of slow-make elements with gold contacts

Slow-make elements with gold contacts do not have certification documents. They are specified for operation for low switching volumes.

rated insulation voltage U_i (as per EN/IEC 60947-5-1, 4.3.1.2) 320VAC

rated operating voltage U_e (as per EN/IEC 60947-5-1, 4.3.3.1) 50 VAC/VDC

conventional thermal current

I_{th}

recommended operational data in control switching

for slow-make element with gold contacts
operating voltage operating current
5 VDC 10-20 mA
12 VDC 5-10 mA
24 VDC 3-5 mA

recommended minimum operational data for slow-make element with gold contacts

operating voltage 10 mVAC/mVDC
operating current 2 mA

volume resistivity in new state (slow-make element with gold contacts)

gold contact ("low-level contact") as per EN/IEC 60512-2-3, Test 2a, at 20 mV, 10 mA = 20 m Ω

protection class

II

0.2 A

electric strength

as per VDE 0630 (IEC 512-2-11)
4000 VAC, 50 Hz, 1 between all terminals and earth

over voltage category

III

rules

rules

IEC 947-5-1 EN 60 947

approvals

approvals

- CE (declaration of conformity)
- CSA 300 VAC
- ENEC
- UL
- German Lloyd
- CB
- VDE

actuator with flasher element

material

lenses

polymethylmethacrylat PMMA, polycarbonate PC

actuator case

polyetherimide PEI, self-extinguishing

mechanical characteristics

connection method

soldering terminal 2.8 x 0.8 mm

ambient air temperature

0°C to + 45°C
(as per DIN IEC 68-)

electrical characteristics

illumination

incandescent lamp:	14 V, 80 mA or 28 V, 40 mA
Multi-LED:	12 V, 25 mA or 24 V, 12.5 mA

flashing frequency

1 Hz ± 0.25 Hz

making cycle

1:1

operating voltage

AC or DC
12 - 10% or 28 V + 10%

technical drawings

1 indicator complete page 427

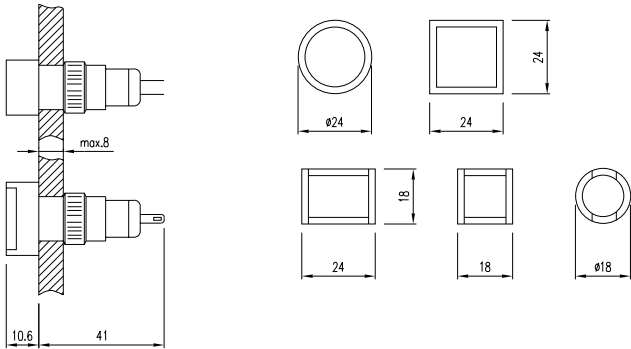

2 indicator actuator page 427

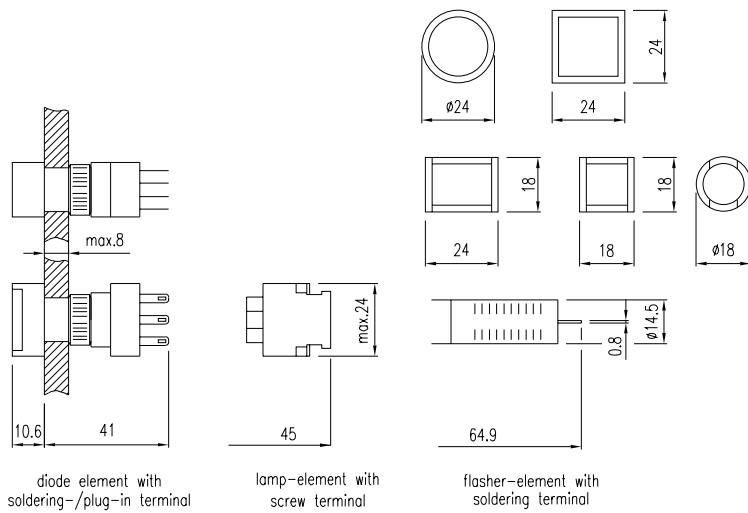

diode element with soldering-/plug-in terminal

lamp-element with screw terminal

flasher-element with soldering terminal

3 illuminated-/pushbutton actuator page 428

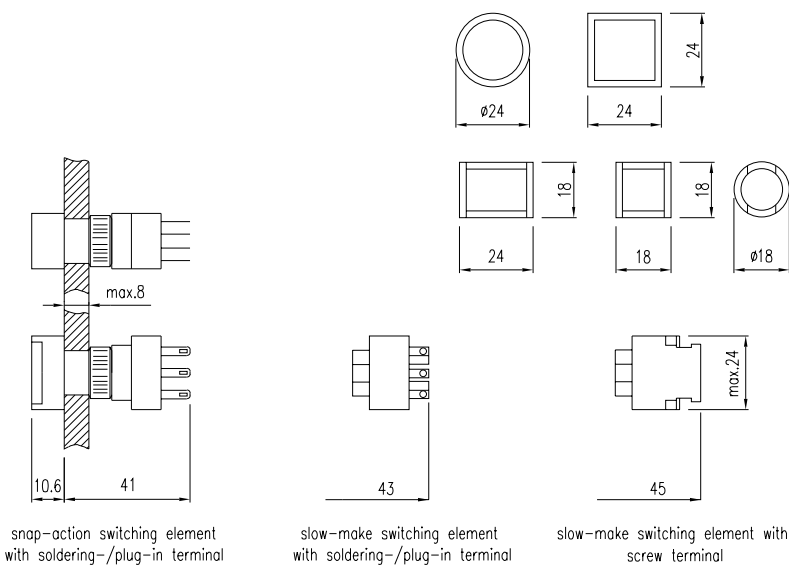

snap-action switching element with soldering-/plug-in terminal

slow-make switching element with soldering-/plug-in terminal

slow-make switching element with screw terminal

4 emergency stop switch actuator foolproof, EN IEC 60947-5-5

page 429

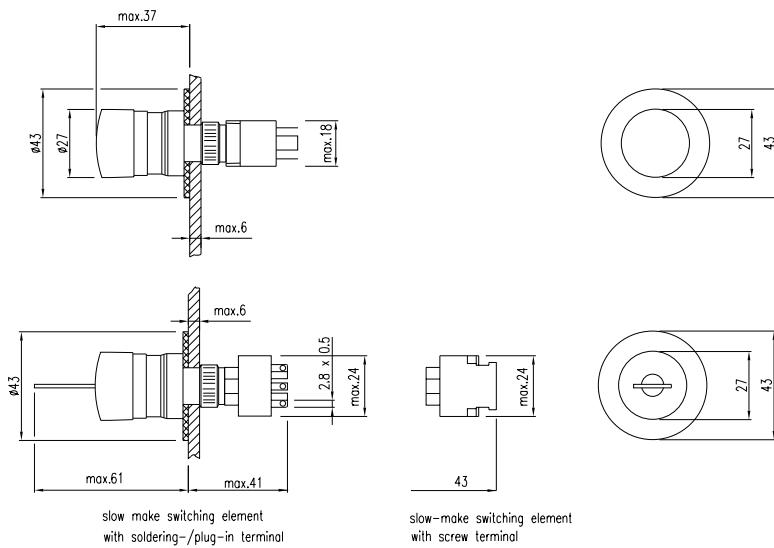

5 pushbutton actuator with mushroom-head cap

page 429

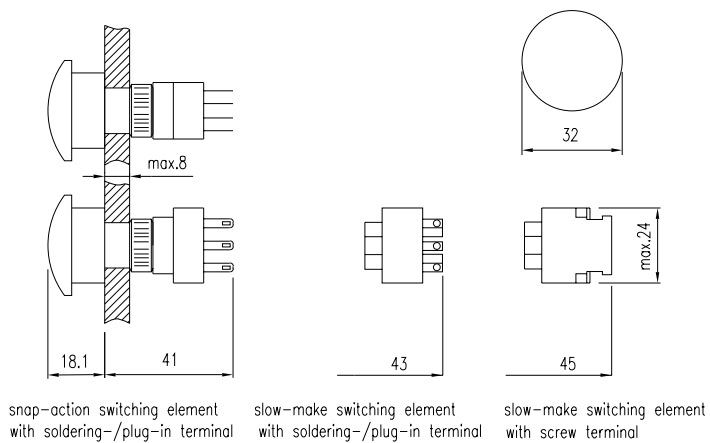

6 keylock switch actuator 2 positions, keylock switch actuator 3 positions

page 430, 431

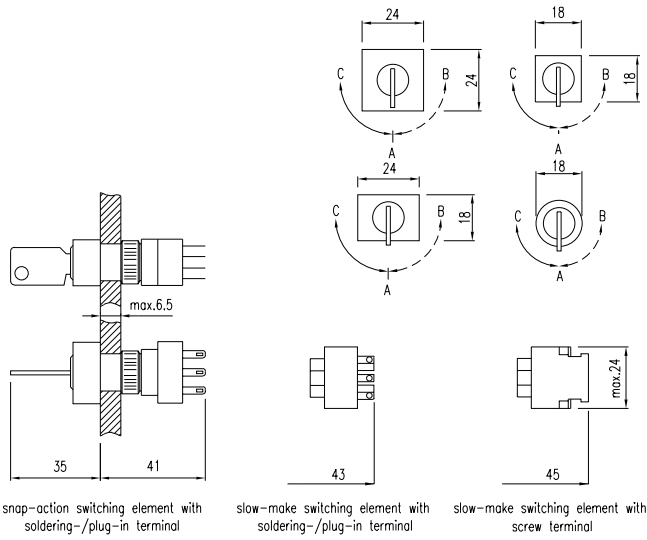

7 selector switch actuator 2 positions, selector switch actuator 3 positions

page 432, 433

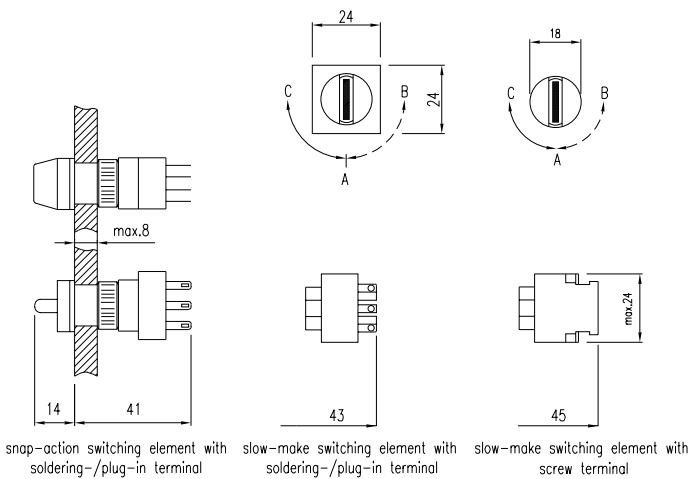

8 indicator complete for flush mounting

page 434

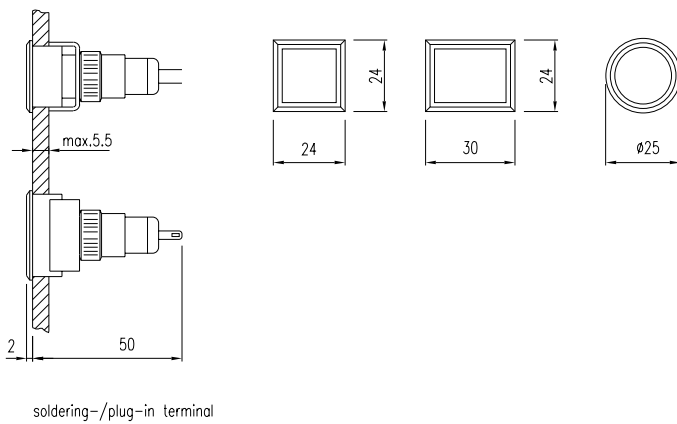

9 indicator actuator for flush mounting

page 434

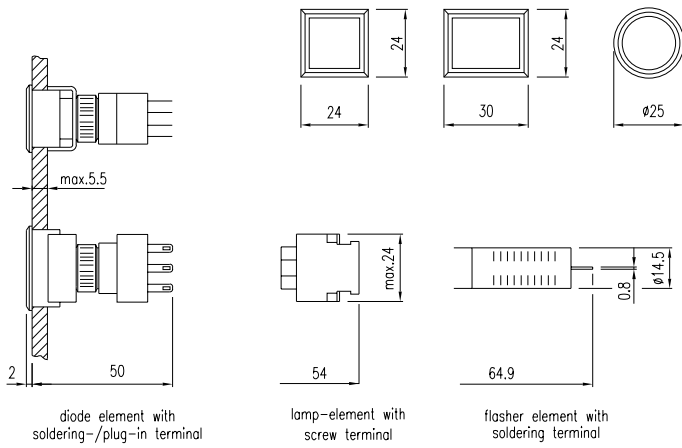

10 illuminated-/pushbutton actuator for flush mounting

page 435

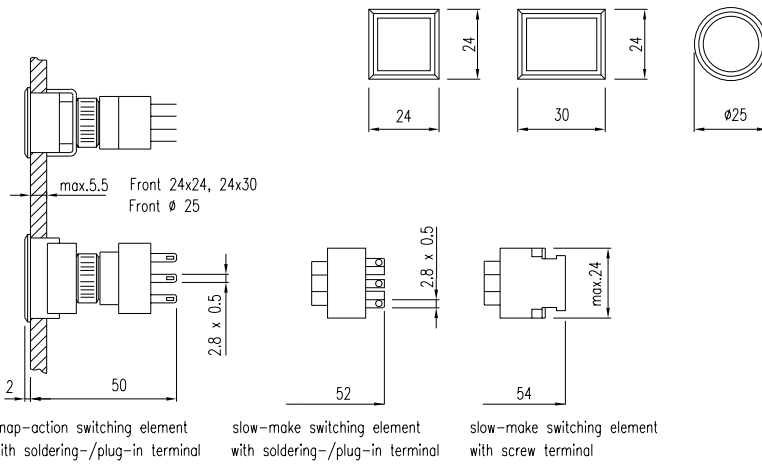

11 pushbutton actuator with mushroom-head cap

page 435

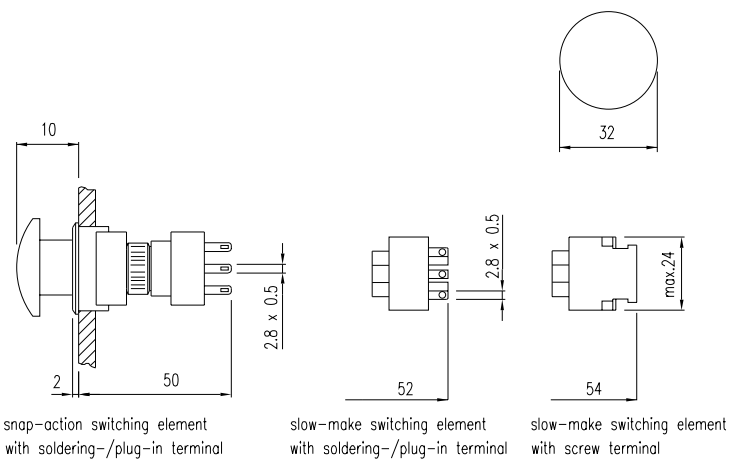

12 keylock switch actuator with 2 positions for flush mounting, keylock switch actuator 3 positions for flush mounting
page 436, 437

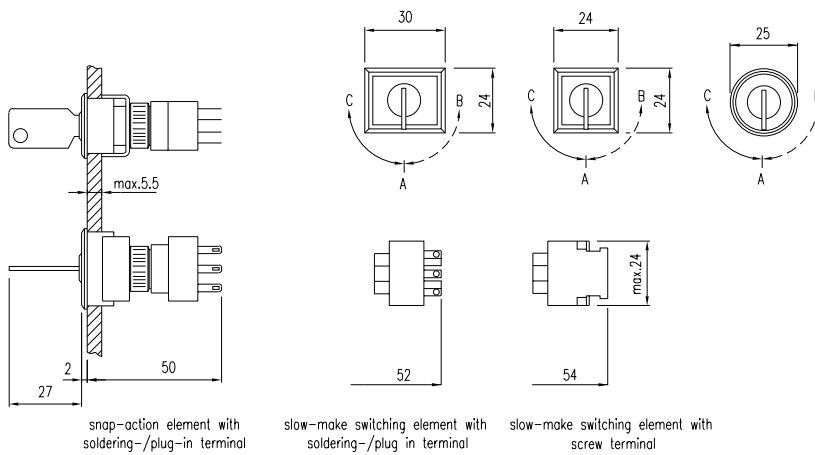

snap-action element with soldering-/plug-in terminal

slow-make switching element with soldering-/plug in terminal

slow-make switching element with screw terminal

13 selector switch actuator 2 positions for flush mounting, selector switch actuator 3 positions for flush mounting
page 438, 438

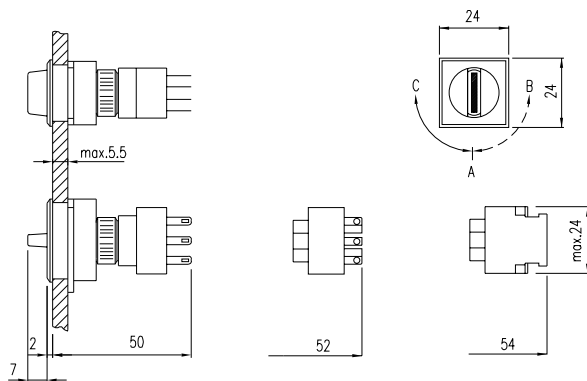

snap-action switching element with soldering-/plug-in element

slow-make switching element with soldering-/plug-in terminal

slow-make switching element with screw terminal

14 protective cover
page 443

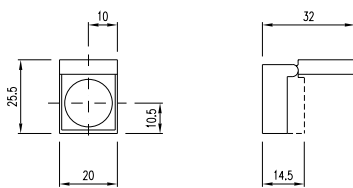

15 protective cover
page 443

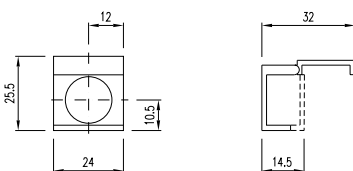

16 protective cover

page 443

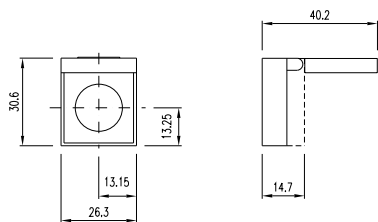

mounting dimensions

1 indicator complete, indicator actuator, illuminated-/pushbutton actuator, keylock switch actuator 2 positions, keylock switch actuator 3 positions, selector switch actuator 2 positions, selector switch actuator 3 positions, blind plug projecting
page 427, 427, 428, 430, 431, 432, 433, 444

Ø24mm/24x24mm

18x24mm

Ø18mm/18x18mm

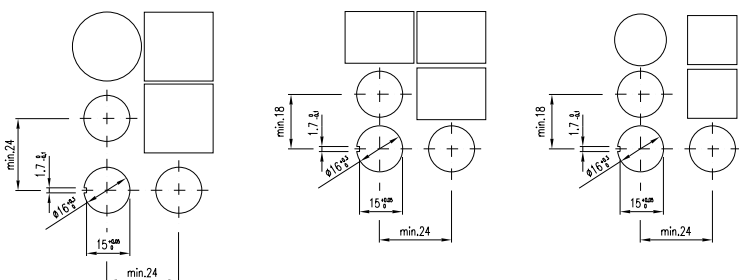

2 emergency stop switch actuator foolproof, EN IEC 60947-5-5, pushbutton actuator with mushroom-head cap
page 429, 429

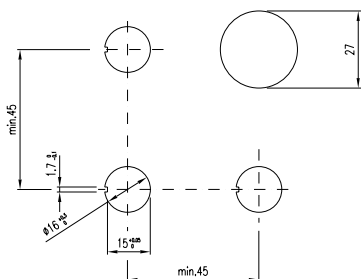

3 indicator complete for flush mounting, indicator actuator for flush mounting, illuminated-/pushbutton actuator for flush mounting, keylock switch actuator with 2 positions for flush mounting, keylock switch actuator 3 positions for flush mounting, selector switch actuator 2 positions for flush mounting, selector switch actuator 3 positions for flush mounting, blind plug flat
page 434, 434, 435, 436, 437, 438, 438, 444

Ø25mm

24 x 30mm

24 x 24mm

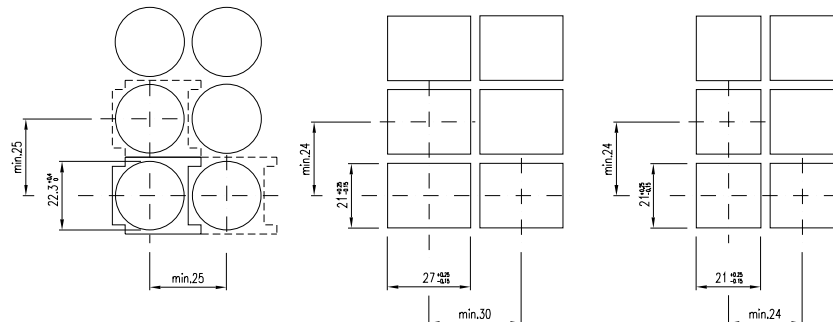

component layouts

1 diode element
page 445

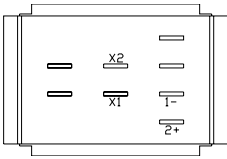

2 diode element
page 445

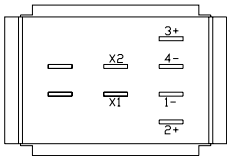

3 switching element for illuminated-/pushbutton, keylock-/selector switch 2 positions
page 446

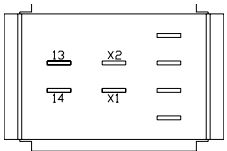

4 switching element for illuminated-/pushbutton, keylock-/selector switch 2 positions
page 446

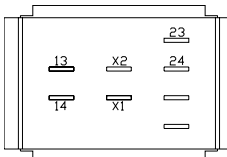

5 switching element for illuminated-/pushbutton, keylock-/selector switch 2 positions
page 446

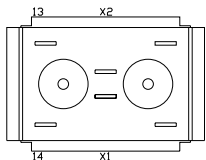

6 switching element for illuminated-/pushbutton, keylock-/selector switch 2 positions
page 446

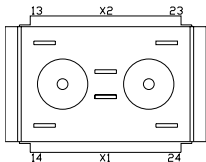

7 switching element for illuminated-/pushbutton, keylock-/selector switch 2 positions
page 446

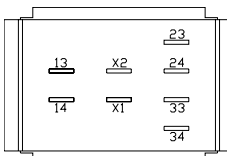

8 switching element for illuminated-/pushbutton, keylock-/selector switch 2 positions
page 446

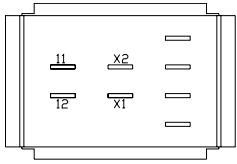

9 switching element for illuminated-/pushbutton, keylock-/selector switch 2 positions
page 446

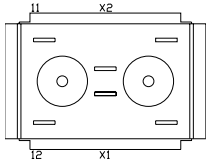

10 switching element for illuminated-/pushbutton, keylock-/selector switch 2 positions
page 446

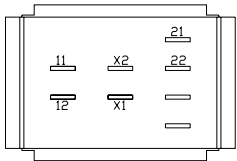

11 switching element for illuminated-/pushbutton, keylock-/selector switch 2 positions
page 446

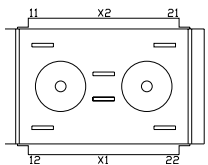

12 switching element for illuminated-/pushbutton, keylock-/selector switch 2 positions
page 446

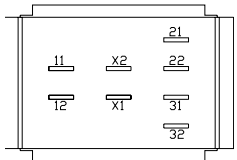

13 switching element for illuminated-/pushbutton, keylock-/selector switch 2 positions
page 446

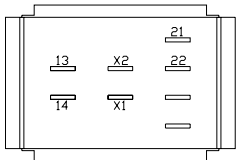

14 switching element for illuminated-/pushbutton, keylock-/selector switch 2 positions
page 446

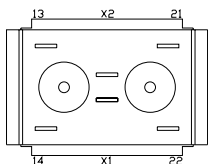

15 switching element for illuminated-/pushbutton, keylock-/selector switch 2 positions
page 446

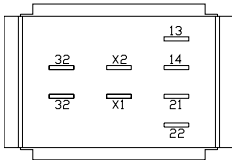

16 switching element for illuminated-/pushbutton, keylock-/selector switch 2 positions
page 446

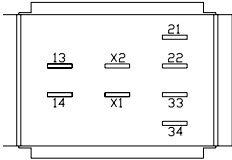

17 switching element for illuminated-/pushbutton, keylock-/selector switch 2 positions
page 446

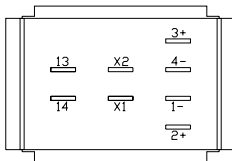

18 switching element for emergency stop switch
page 447

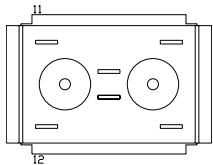

19 switching element for emergency stop switch
page 447

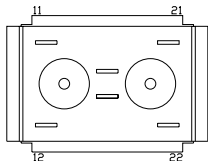

20 switching element for emergency stop switch
page 447

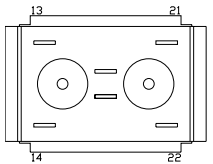

21 switching element for keylock-/selector switch 3 positions
page 447

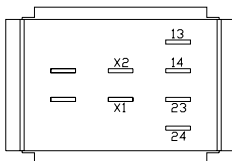

22 switching element for keylock-/selector switch 3 positions
page 447

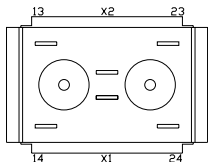

23 switching element for keylock-/selector switch 3 positions
page 447

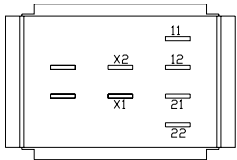

24 switching element for keylock-/selector switch 3 positions
page 447

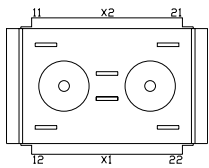

25 switching element for keylock-/selector switch 3 positions
page 447

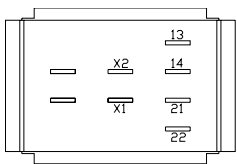

26 switching element for keylock-/selector switch 3 positions
page 447

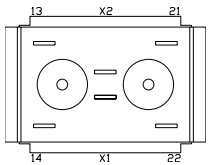

27 PCB plug-in base
page 448

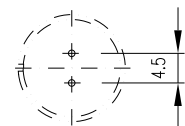

28 PCB plug-in base
page 448

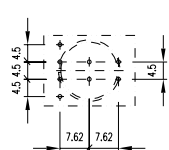

29 PCB plug-in base
page 448

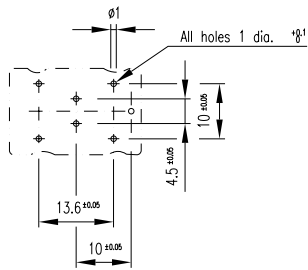

Note:

More information about the PCB-Software can be found at www.pcad.com/en/library.

circuit drawings

1 indicator complete, indicator actuator, indicator complete for flush mounting, indicator actuator for flush mounting, lamp element
427, 427, 434, 434, 445

x1-



x2+

2 illuminated-/pushbutton actuator, pushbutton actuator with mushroom-head cap
page 428, 429

x1-

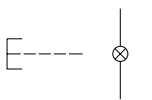

x2+

3 illuminated-/pushbutton actuator, pushbutton actuator with mushroom-head cap
page 428, 429

x1-

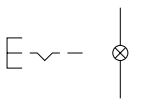

x2+

4 emergency stop switch actuator foolproof, EN IEC 60947-5-5
page 429



5 keylock switch actuator 2 positions, keylock switch actuator with 2 positions for flush mounting, keylock switch actuator 3 positions for flush mounting
page 430, 436, 437



6 keylock switch actuator 2 positions, keylock switch actuator with 2 positions for flush mounting
page 430, 436



7 keylock switch actuator 3 positions, keylock switch actuator 3 positions for flush mounting
page 431, 437

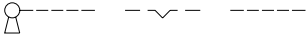

8 keylock switch actuator 3 positions, keylock switch actuator 3 positions for flush mounting
page 431, 437



9 keylock switch actuator 3 positions, keylock switch actuator 3 positions for flush mounting
page 431, 437



10 keylock switch actuator 3 positions, keylock switch actuator 3 positions for flush mounting
page 431, 437



11 keylock switch actuator 3 positions
431

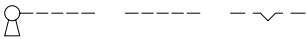

12 selector switch actuator 2 positions, selector switch actuator 2 positions for flush mounting
page 432, 438



13 selector switch actuator 2 positions, selector switch actuator 2 positions for flush mounting
page 432, 438

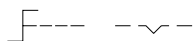

14 selector switch actuator 3 positions, selector switch actuator 3 positions for flush mounting
page 433, 438



15 selector switch actuator 3 positions, selector switch actuator 3 positions for flush mounting
page 433, 438,



16 selector switch actuator 3 positions, selector switch actuator 3 positions for flush mounting
page 433, 438

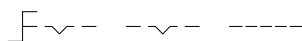

17 selector switch actuator 3 positions, selector switch actuator 3 positions for flush mounting
page 433, 438



18 illuminated-/pushbutton actuator for flush mounting
page 435

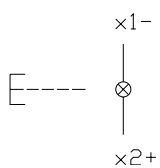

19 illuminated-/pushbutton actuator for flush mounting
page 435

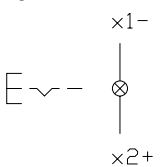

20 diode element

page 445

x1- 2+



x2+ 1-

21 diode element

page 445

x1- 2+ 3+

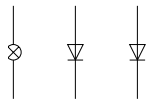

x2+ 1- 4-

22 switching element for illuminated-/pushbutton, keylock-/selector switch 2 positions

page 446

13 x1-

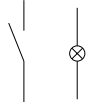

14 x2+

23 switching element for illuminated-/pushbutton, keylock-/selector switch 2 positions, switching element for keylock-/selector switch 3 positions

page 446, 447

13 23 x1-

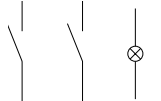

14 24 x2+

24 switching element for illuminated-/pushbutton, keylock-/selector switch 2 positions

page 446

13 23 33 x1-

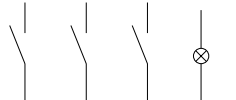

14 24 34 x2+

25 switching element for illuminated-/pushbutton, keylock-/selector switch 2 positions

page 446

11 x1-

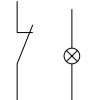

12 x2+

26 switching element for illuminated-/pushbutton, keylock-/selector switch 2 positions

page 446

11



12

27 switching element for illuminated-/pushbutton, keylock-/selector switch 2 positions, switching element for keylock-/selector switch 3 positions

page 446, 447

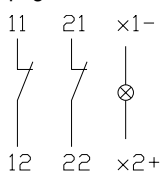

28 switching element for illuminated-/pushbutton, keylock-/selector switch 2 positions

page 446



29 switching element for illuminated-/pushbutton, keylock-/selector switch 2 positions

page 446

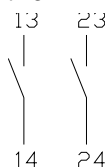

30 switching element for illuminated-/pushbutton, keylock-/selector switch 2 positions, switching element for keylock-/selector switch 3 positions

page 446, 447

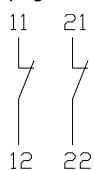

31 switching element for illuminated-/pushbutton, keylock-/selector switch 2 positions

page 446

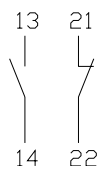

32 switching element for illuminated-/pushbutton, keylock-/selector switch 2 positions

page 446

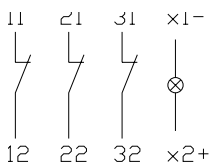

33 switching element for illuminated-/pushbutton, keylock-/selector switch 2 positions, switching element for keylock-/selector switch 3 positions

page 446, 447,

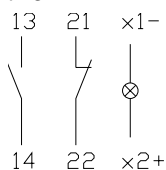

34 switching element for illuminated-/pushbutton, keylock-/selector switch 2 positions

page 446

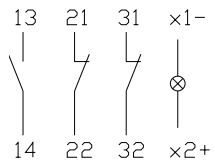

35 switching element for illuminated-/pushbutton, keylock-/selector switch 2 positions

page 446

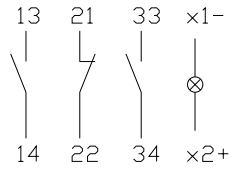

36 switching element for illuminated-/pushbutton, keylock-/selector switch 2 positions

page 446

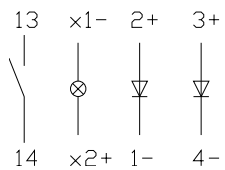

37 switching element for emergency stop switch

page 447

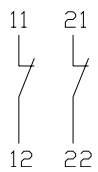

38 switching element for emergency stop switch

page 447

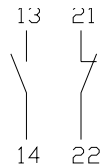

39 switching element for emergency stop switch

page 447



With indicators and illuminated pushbuttons equipped with diodes, the user is able to perform a lamp check or wire an alarm circuit simply with a considerable saving of space.

lamp check

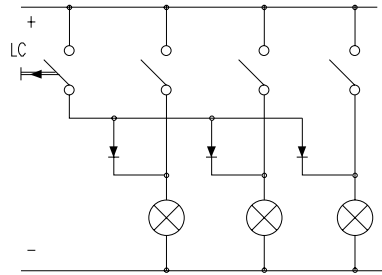

lamp check with blocking diodes

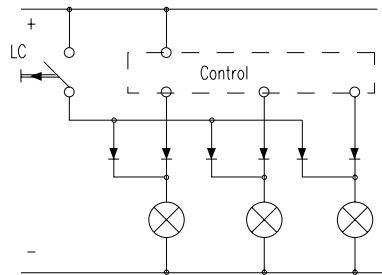

alarm circuit from fault
annunciating system

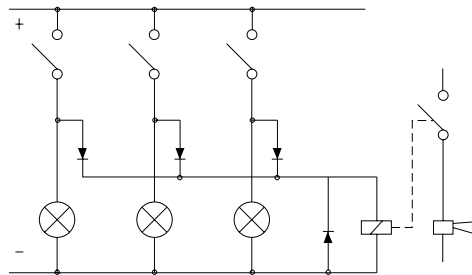

lamp check and alarm circuit

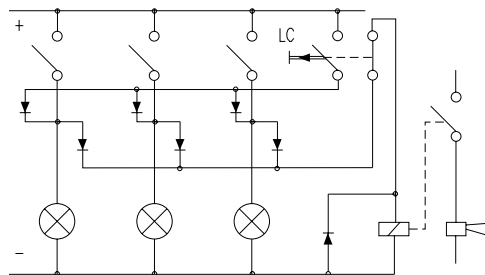

lamp check and alarm circuit with
only one diode and AC voltage

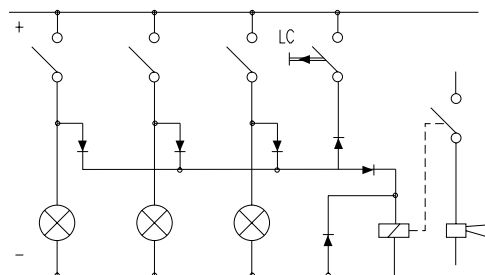

LC = lamp check

Flasher element

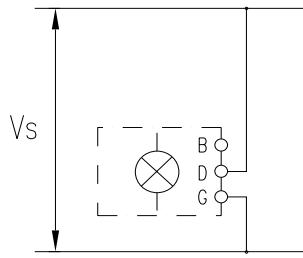

1. Continuous light

1. Engraving

Typefaces

In addition to the most commonly used world languages (see DIN 1451) with close spacing, the following typefaces are available: Scandinavian, Slavian, Greek, Russian.

Coloured filling of engraving

Specify whether engraving should be on the diffuser, or on the lens.
Specify the infill colour, character height and the text or symbol orientation.

Symbols

A list of the symbols available can be supplied on request.

2. Hot stamping

For large batches it is worth while to have the lettering produced by hot stamping.

Typefaces

For letters and figures, typefaces with 2,5 mm, 3 mm and 4 mm are available.

Symbols

A list of the symbols available can be supplied on request.

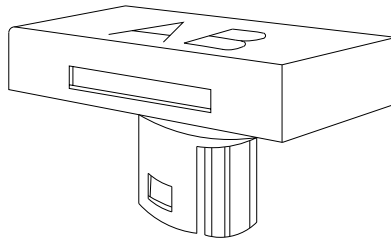

Important!

Before engraving, check the position of the illuminated pushbutton or indicator

Height of letters mm	(switch) lens Thickness of letters mm	(18 x 24) 15,3 x 21,5 mm			(Ø 18) Ø 15,8 mm			(18 x 18) 15,3 x 15,3 mm					
		Horizontal mounting		Vertical mounting	Horizontal mounting		Vertical mounting	Horizontal mounting		Vertical mounting			
h	s	Number of lines	Number of letters per line (caps)	Number of letters per line (small)	Number of lines	Number of letters per line (caps)	Number of letters per line (small)	Number of lines	Number of letters per line (caps)	Number of letters per line (small)	Number of lines	Number of letters per line (caps)	Number of letters per line (small)
2,5	0,4	4	11	12	5	7-8	8	3	6	6	4	7-8	8
3	0,4	3	9-10	10-11	4	6-7	7	2	5	6	3	6-7	7
4	0,5	2	7	7-8	3	4-5	5	2	3	4	2	4-5	5
5	0,5	2	5-6	6	2	3-4	4	1	2	3	2	3-4	4
6	0,6	1	4-5	5	2	3	3-4	1	2	2	1	3	3-4
8	0,6	1	3-4	3-4	1	2-3	2-3	1	2	2	1	2-3	2-3
Film dimension		□ max. 12,7 x 18,7 mm						Ø 12,8 mm			□ 12,7 x 12,7 mm		

3. Film inserts

Instead of using engraving, the lenses can be fitted with transparent film inserts.

For this purpose, though, it is advisable to use transparent lenses. When a smoked lens is used, the lettering does not become visible until the lamp lights.

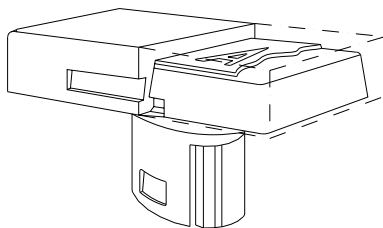

Film dimensions

16,9x16,9 mm
11,9x11,9 mm
max 11,9x18,0 mm

Film thickness

0.2 mm

Important!

Before engraving, check the position of the illuminated pushbutton or indicator.

Height of letters		Thickness of letters		Number of lines		Number of letters per line		Number of letters per line		Number of lines		Number of letters per line		Number of letters per line		Number of lines		Number of letters per line		Number of letters per line	
h	s	(caps)	(small)	(caps)	(small)	(caps)	(small)	(caps)	(small)	(caps)	(small)	(caps)	(small)	(caps)	(small)	(caps)	(small)	(caps)	(small)	(caps)	(small)
2,5	0,4	3	6	6	4	9	10	4	12	13	5	8-9	9	4	8-9	9					
3	0,4	2	5	6	3	7-8	9	3	10-11	11-12	4	7-8	8	3	7-8	8					
4	0,5	2	3	4	2	4-5	5	2	7	8	3	4-5	5	2	4-5	5					
5	0,5	1	2	3	2	4	4-5	2	5-6	6	2	4	4-5	2	4	4-5					
6	0,6	1	2	3	1	4	4	1	4-5	5	2	3	3-4	1	4	4					
8	0,6	1	2	2	1	2	2	1	3-4	3-4	1	2-3	2-3	1	2-3	2-3					
Film dimension						□ 16,9 x 16,9 mm				□ 15,1 x 21 mm				□ 15,1 x 15,1 mm							

	EAO AG Tannwaldstrasse 88 4601 Olten, Switzerland
E-mail	info@eao.com
Website	www.eao.com
	Belgium
Phone	+32/2 456 00 10
E-mail	sales.ebl@eao.com
	China
Phone	+852/27 86 91 41
E-mail	sales.ehk@eao.com.hk
	France
Phone	+33/1 64 43 37 37
E-mail	sales.es@eao.com
	Germany
Phone	+49/201 85 87 0
E-mail	sales.ede@eao.com
	Japan
Phone	+81/3 5401 0953
E-mail	sales.esj@eao.com
	Netherlands
Phone	+31/78 653 17 00
E-mail	sales.enl@eao.com
	Sweden
Phone	+46/8 683 86 60
E-mail	sales.esw@eao.com
	Switzerland
Phone	+41/62 388 95 00
E-mail	sales.ech@eao.com
	United Kingdom
Phone	+44/1444 236000
E-mail	sales.euk@eao.com
	USA
Phone	+1/203 877 4577
E-mail	sales.eus@eao.com
	Other Countries
Fax	+41/62 296 21 62
E-mail	info@eao.com
Website	www.eao.com