

EPIC® LS1 Series Circular Power & Mixed Power Connectors

EPIC® LS1 Circular and Mixed Power Connectors are designed to DIN specification EN61984 and have a standard M23 threaded connection housing. They are offered in male coupler, female connector, and male inlet configurations that satisfy simple cable-to-cable and cable-to-machine requirements. They are ideal for power transmission and servo drive applications in the plastics, printing, analytical instrument, robotic, machine tool industries, and any other industrial or commercial application where a compact connector with high voltage and current capability is required.



800-774-3539
www.lappusa.com



LAPP USA

EPIC® LS1 Series Circular Power & Mixed Power Connectors

Equipment Description

EPIC® LS1 Connectors are available in five housing arrangements and two contact configurations. Common to all arrangements are a rugged nickel plated zinc body, plastic contact insulation body and sleeve, and gold plated electrical contacts (included with the connector part number). Cable mounted arrangements also include an integral EMC shield ring and cable clamp and seal. The figure to the right shows the general construction of these connectors.

These connectors are offered with a 5+PE contact configuration for power distribution (5 contacts plus ground rated at 630 volts and 22 amps), and a 3+PE+4 contact configuration for mixed power and signal requirements for servo motor with brake and feedback applications (3 contacts plus ground rated 630 volts and 22 amps and 4 contacts rated 250 volts and 7 amps). Used in combination, they connect one flexible cable with another (cable coupler) or one flexible cable to fixed wiring on a machine (appliance coupler).

Features & Benefits



The new EPIC® LS1 connectors have many inherent features which offer application advantages and provide significant benefits. These features make it one of the most application friendly connectors available, and insure quick and easy assembly, high reliability, and long, uninterrupted service life in tough industrial environments.

Key features include:

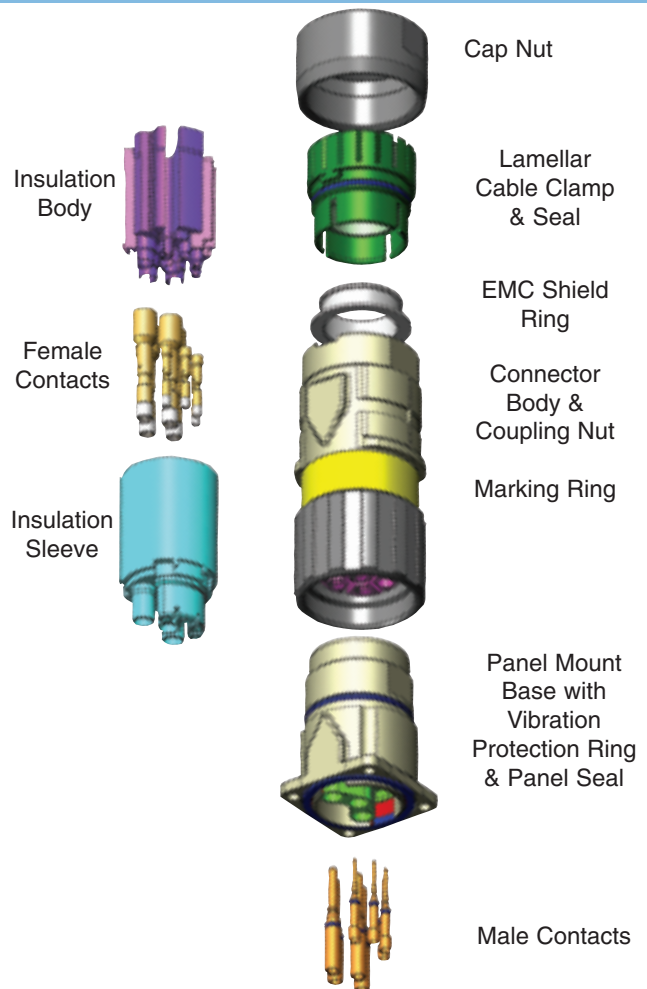
- Rugged nickel-plated, die-cast zinc body
- Positive vibration protection for use with motor drives and moving assemblies
- Integral EMC cable gland provides strain-relief, IP67/68 protection, and 360° shielding
- Identification marking field and optional color marking clips can be used to provide positive identification and visual differentiation in multiple connector installations.



Technical Specifications

# of Contacts:	5+PE, 3+PE+4
Rated Voltage:	VDE: 630V (2mm contacts) 250V (1mm contacts) UL: 600V
Rated Current:	22 amps (2mm contacts) 7 amps (1mm contacts)
Impulse Voltage:	6kV (2mm contacts) 4kV (1mm contacts)
Contact Resistance:	<5m Ohms
Mating Cycles:	500
Temperature Range:	-25°C to +125°C
Protection Class:	IP67/68 (10h/1m)
Wire Gauge (Crimp):	<u>2 mm contacts:</u> 0.5 to 2.5 mm ² (20-14 AWG) <u>1 mm contacts:</u> 0.14 to 1.0 mm ² (24-18 AWG)
Cable Diameter:	7.5 to 15.5 mm
Materials:	Housing: Nickel Plated Zinc (Die Cast) Insulation Body: PA, PBT, UL94 V-0 Contacts: Gold plated copper alloy Gaskets & Seals: FPM
Standards:	DIN EN 61984
Approvals:	 

EPIC® LS1 Series Circular Power

5+PE

Male Insert



View from contact side

Female Insert



3+PE+4

Male Insert



View from contact side

Female Insert



Derating Curve

Basic and derating curve LS-1, 5+PE, 2,5 mm²
Female hyper boloid

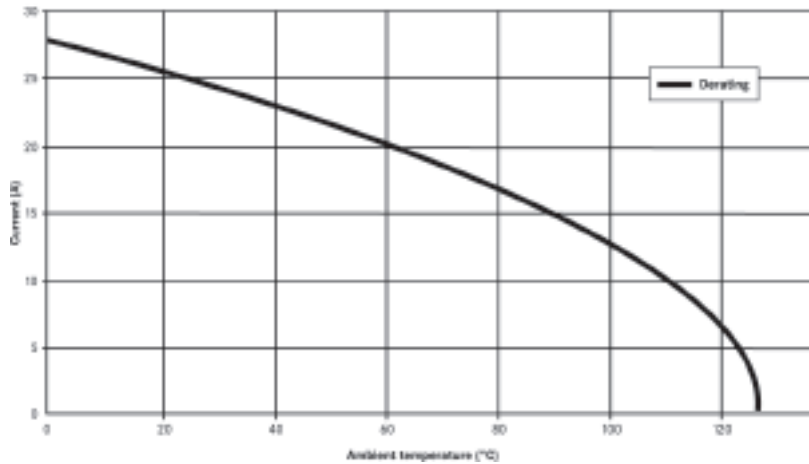

Wire Gauge	Max. Current (A) According to UL	
	5+PE	3+PE+4
2mm Contacts		
AWG 14	22	22
AWG 18	13	13
AWG 20	9	9
AWG 22	5	5
1mm Contacts		
AWG 18	-	7
up to AWG 26	-	1

STRAIGHT PANEL MOUNT INLET WITH MALE CONTACTS (STYLE A1)

5+PE

76.003000



3+PE+4

76.004000

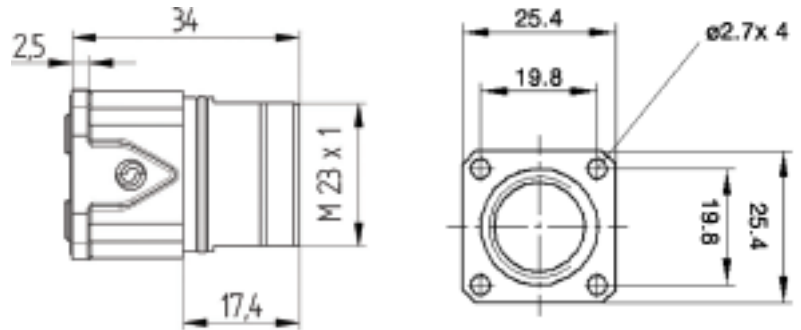

Male Contacts (Spare Parts)

Part #	Description	Pack Size
74.033001	0.14 - 1.0 mm ²	10
74.033000	0.14 - 1.0 mm ²	100
74.033101	0.50 - 2.5 mm ²	10
74.033100	0.50 - 2.5 mm ²	100

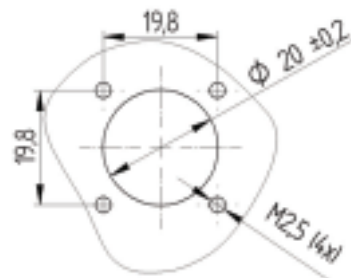

& Mixed Power Connectors

CABLE CONNECTOR WITH FEMALE CONTACTS (STYLE D6)

Short Body

5+PE



76.123100

3+PE+4



76.124100

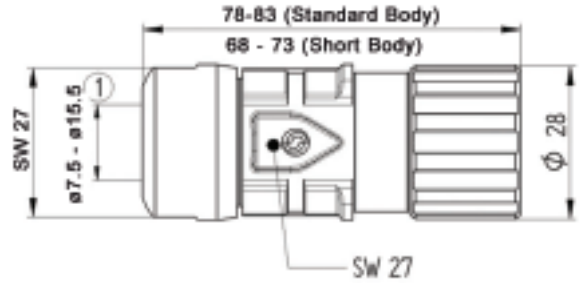

Standard Body

5+PE



76.123000

3+PE+4



76.124000

Female Contacts (Spare Parts)

Part #	Description	Style	Pack Size
74.033501	0.14 - 1.0 mm ²	Slot	10
74.033500	0.14 - 1.0 mm ²	Slot	100
74.034501	0.14 - 1.0 mm ²	Hyper boloid	10
74.034500	0.14 - 1.0 mm ²	Hyper boloid	100
74.034601	0.50 - 2.5 mm ²	Hyper boloid	10
74.034600	0.50 - 2.5 mm ²	Hyper boloid	100

CABLE COUPLER WITH MALE CONTACTS (STYLE F6 & F7)

Style F6

5+PE



76.133000

3+PE+4



76.134000

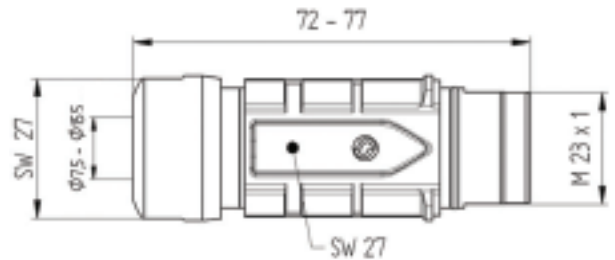

Style F7

5+PE



76.143000

3+PE+4



76.144000

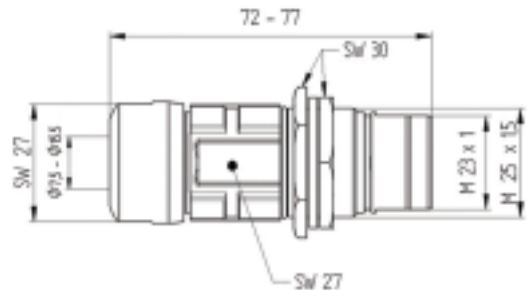

Male Contacts (Spare Parts)

Part #	Description	Pack Size
74.034001	0.14 - 1.0 mm ²	10
74.034000	0.14 - 1.0 mm ²	100
74.034101	0.50 - 2.5 mm ²	10
74.034100	0.50 - 2.5 mm ²	100

TOOLS & ACCESSORIES



Crimp Tool
0.14 - 6.0 mm²
11.1480



Locator
11.1483



Removal Tool
1mm Contacts: 75.017400
2mm Contacts: 75.017500



Metal Screw Cap
Style A1: 75.018210
Style F6, F7: 75.018310



Plastic Protection Cap
Style D6: 75.007710
Style A1, F6, F7: 75.007810



**Yellow Marking
Rings**
75.013410



**Red Marking
Rings**
75.013110



**Blue Marking
Rings**
75.013210



**Green Marking
Rings**
75.013310



**Transparent
Marking Rings**
75.013010

Application with OLFLEX® Servo Cables

Stationary Applications

Cable Series	Use with LS1 (5+PE)		Use with LS1 (3+PE+4)	
	Part Number	Conductor Configuration	Part Number	Conductor Configuration
OLFLEX®-Servo 709 CY UL/CSA/CE	0038010	16 AWG/4c	0038021	16 AWG/4c + 2pr 19
	0038011	14 AWG/4c	0038022	14 AWG/4c + 2pr 18
OLFLEX®-Servo 700 CE	-	-	0036145	16 AWG/4c + 2pr 19
	-	-	0036150	14 AWG/4c + 2pr 19
OLFLEX®-Servo 700 CY CE	-	-	0036157	16 AWG/4c + 2pr 19
	-	-	0036158	14 AWG/4c + 2pr 19
OLFLEX®-Servo LK-SMS-FX5 UL/CSA/VDE/CE	0025700	16 AWG/4c	0025715	16 AWG/4c + 1pr 16
	0025701	14 AWG/4c	0025716	14 AWG/4c + 1 pr16

Continuous Flex Applications

Cable Series	Use with LS1 (5+PE)		Use with LS1 (3+PE+4)	
	Part Number	Conductor Configuration	Part Number	Conductor Configuration
OLFLEX®-Servo FD 750 P CE	-	-	36245	16 AWG/4c + 2pr 18
	-	-	36250	14 AWG/4c + 2pr 18
OLFLEX®-Servo FD 750 CP UL/CSA/CE	-	-	32322UL	16 AWG/4c + 2pr 17
OLFLEX®-Servo FD 755 P CE	-	-	36350	16 AWG/4c + 2pr 18
	-	-	36351	14 AWG/4c + 2pr 18
OLFLEX®-Servo FD 755 CP CE	-	-	36370	16 AWG/4c + 1pr 17
	-	-	36371	14 AWG/4c + 1pr 17
	-	-	36360	16 AWG/4c + 2pr 18
OLFLEX®-Servo LK-SMS-FX8 UL/CSA/VDE/CE	0027724	16 AWG/4c	0027718	16 AWG/4c + 1pr 16
	0027725	14 AWG/4c	0027719	14 AWG/4c + 1pr 16
OLFLEX®-Servo LK-INX UL/CSA/CE	-	-	7072404	16 AWG/4c + 2pr 19
	-	-	7072405	14 AWG/4c + 2pr 18