

Actual information about approvals can be found on
<http://www.schurter.com/approvals>



C14



70° C

Description

- Panel mount:
Screw-on version from front side
- 4 Functions:
Connector Protection class I, Fuseholder for fuse-links 5 x 20 mm 1-pole, Line switch 2-pole, Line-filter in standard version 2-stage
Quick connect terminals 6.3 x 0.8 mm

Characteristics

- Compact design with optimal shielding
- All single elements are already wired
- The fuseholder is accessible from the equipment front
- Qualified for use in equipment according IEC/EN 60950

Technical data

Ratings IEC	1 - 10 A @ Ta 40 °C / 250 VAC; 50 Hz
Ratings UL/CSA	1 - 10 A @ Ta 40 °C / 125 VAC; 60 Hz
Leakage current	standard < 0.25 mA (250 V / 60 Hz)
Dielectric strength	> 1.7 kVDC between L-N
	> 2.7 kVDC between L/N-PE Test voltage (2 sec)
Allowable operation temp.	-25 °C to 85 °C
Climatic category	25/085/21, IEC 60068-1
Degree of protection	from front side IP40 acc. to IEC 60529
Protection class	Suitable for appliances with protection class I acc. to IEC 61140
Terminals	Quick connect terminals 6.3 x 0.8 mm
Panel thickness s	Screw-on max 8 mm
	Mounting screw torque max 0.5 Nm
Materials: Housing	Thermoplastic, black, UL 94V-0

Appliance-inlet /-outlet	C14 acc. to IEC/EN 60320-1, UL 498, CSA C22.2 no. 42 (for cold condition) pin-temperature 70 °C, 10 A, Protection class I
Fuseholder	1-pole, Shocksavve category PC2 acc. to IEC/EN 60127-6, for fuse-links 5 x 20 mm
Power acceptance @ Ta > 23°C	Admissible power acceptance at higher ambient temperature see derating curves. Take note of the information GENERAL PRODUCT INFORMATION
Line switch	Rocker switch 2-pole, non-illuminated, acc. to IEC 61058-1 Technical details GENERAL PRODUCT INFORMATION
Line filter	Standard Version, IEC 60939, IEC 60601-1, UL 1283, UL 544, EN 133 200, CSA C22.2 no. 8 Technical details GENERAL PRODUCT INFORMATION

Dimensions
Case 45

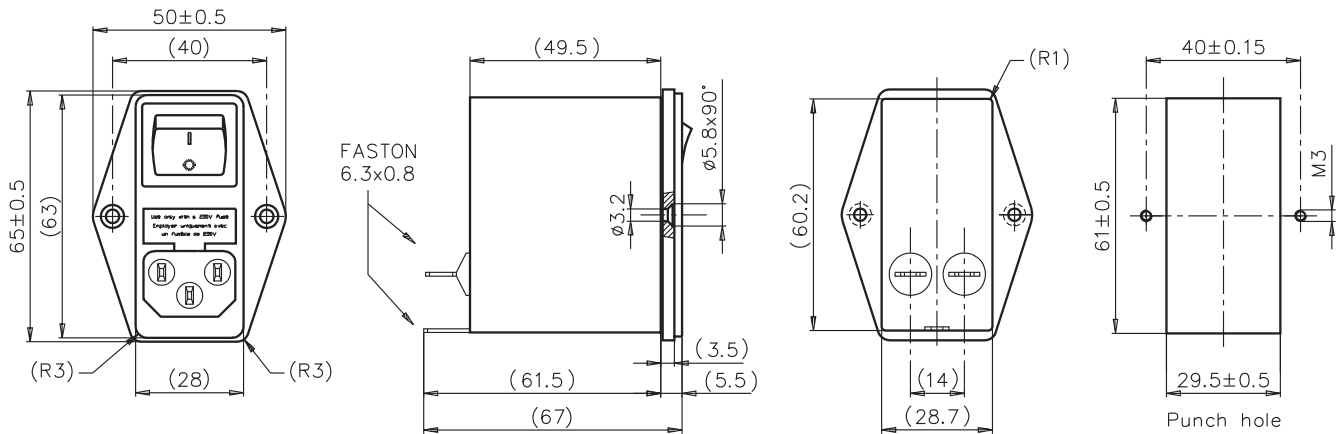

Technical data of filter-components

Rated current [A]	Filter-Type	Inductances L [mH]	Capacitance CX [nF]	Capacity Cy1 [nF]	Capacity Cy2 [nF]	R [MΩ]
1	Standard Version	2 x 10	68	1.5	1	1
2	Standard Version	2 x 4	68	1.5	1	1
4	Standard Version	2 x 1.5	68	1.5	1	1
6	Standard Version	2 x 0.8	68	1.5	1	1
10	Standard Version	2 x 0.3	68	1.5	1	1

Diagrams

Standard Version

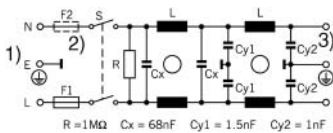

- 1) Line
- 2) only FKID
- 3) Load

Attenuation loss

--- differential mode ____ common mode

Standard version

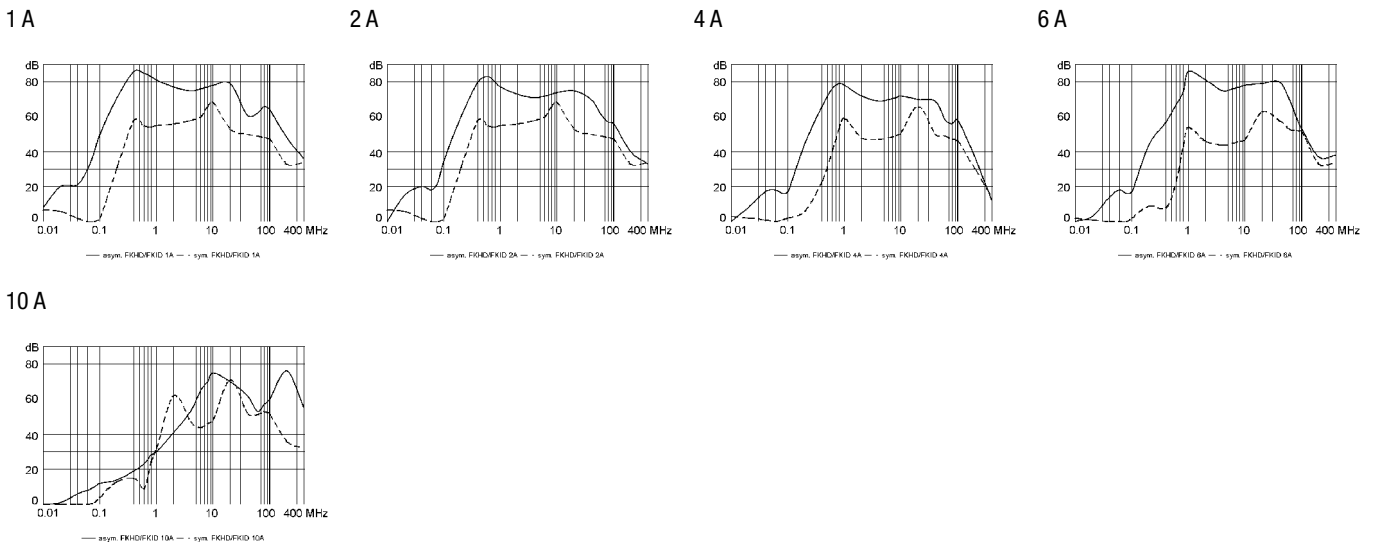

Medical version

1 A

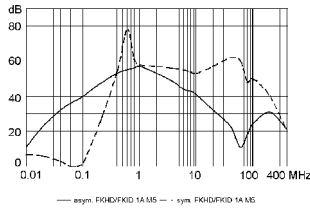

2 A

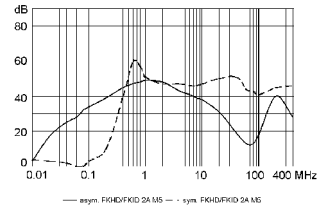

4 A

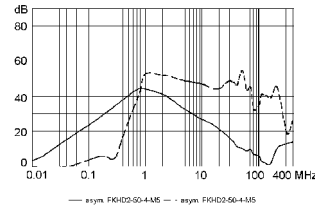

6 A

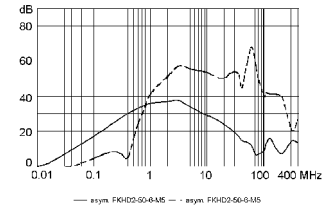

10 A

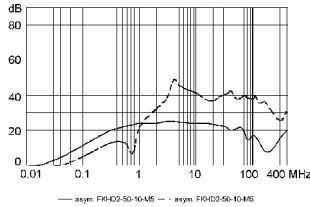

Variants

Order Number	Type	Rated current [A]	Filter-Type	Fuseholder	Line switch	Case	Materials: Housing
4304.5042	FKHD	2	Standard Version	1-pole	2-pole	45	Aluminum
4304.5043	FKHD	4	Standard Version	1-pole	2-pole	45	Aluminum
4304.5044	FKHD	6	Standard Version	1-pole	2-pole	45	Aluminum
4304.5045	FKHD	10	Standard Version	1-pole	2-pole	45	Aluminum
4304.5001	FKHD	1	Standard Version	1-pole	2-pole	45	Nickel plated steel
4304.5002	FKHD	2	Standard Version	1-pole	2-pole	45	Nickel plated steel
4304.5003	FKHD	4	Standard Version	1-pole	2-pole	45	Nickel plated steel
4304.5004	FKHD	6	Standard Version	1-pole	2-pole	45	Nickel plated steel
4304.5005	FKHD	10	Standard Version	1-pole	2-pole	45	Nickel plated steel

Packaging unit

10 Pcs