

IR Receiver Modules for Remote Control Systems

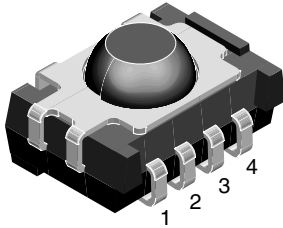

16797

MECHANICAL DATA

Pinning

1 = GND, 2 = N.C., 3 = V_S , 4 = OUT

DESCRIPTION

The TSOP62.., TSOP64.. series are miniaturized SMD-IR receiver modules for infrared remote control systems. PIN diode and preamplifier are assembled on a lead frame, the epoxy package is designed as IR filter.

The demodulated output signal can directly be decoded by a microprocessor. The TSOP62.. is compatible with all common IR remote control data formats. The TSOP64.. is optimized to better suppress spurious pulses from energy saving lamps but will also suppress some data signals.

This component has not been qualified according to automotive specifications.

FEATURES

- Datasheet valid product date code ww 46 2009 onwards
- Photo detector and preamplifier in one package
- Internal filter for PCM frequency
- Supply voltage: 2.7 V to 5.5 V
- Output active low
- Low power consumption
- High immunity against ambient light
- Low power consumption
- Compliant to RoHS directive 2002/95/EC and in accordance to WEEE 2002/96/EC



RoHS
COMPLIANT

SPECIAL FEATURES

- Improved immunity against ambient light
- Suitable burst length ≥ 10 cycles/burst
- Taping available for top view and side view assembly

PARTS TABLE

CARRIER FREQUENCY	STANDARD APPLICATIONS (AGC2/AGC8)	NOISY ENVIRONMENTS AND SHORT BURSTS (AGC4)
30 kHz	TSOP6230	TSOP6430
33 kHz	TSOP6233	TSOP6433
36 kHz	TSOP6236	TSOP6436
36.7 kHz	TSOP6237	TSOP6437
38 kHz	TSOP6238	TSOP6438
40 kHz	TSOP6240	TSOP6440
56 kHz	TSOP6256	TSOP6456

BLOCK DIAGRAM

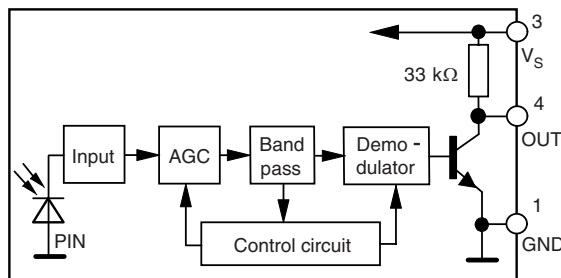

16839-1

APPLICATION CIRCUIT

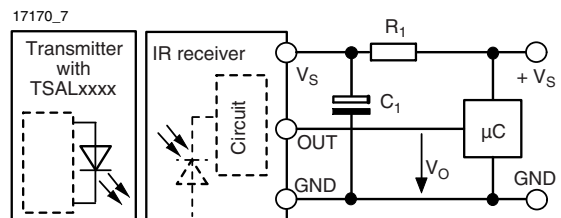

The external components R_1 and C_1 are optional to improve the robustness against electrical overstress (typical values are $R_1 = 100 \Omega$, $C_1 = 0.1 \mu F$). The output voltage V_o should not be pulled down to a level below 1 V by the external circuit. The capacitive load at the output should be less than 2 nF.

ABSOLUTE MAXIMUM RATINGS ⁽¹⁾				
PARAMETER	TEST CONDITION	SYMBOL	VALUE	UNIT
Supply voltage (pin 3)		V_S	- 0.3 to + 6	V
Supply current (pin 3)		I_S	5	mA
Output voltage (pin 4)		V_O	- 0.3 to 5.5	V
Voltage at output to supply		$V_S - V_O$	- 0.3 to ($V_S + 0.3$)	V
Output current (pin 4)		I_O	5	mA
Junction temperature		T_j	100	°C
Storage temperature range		T_{stg}	- 40 to + 100	°C
Operating temperature range		T_{amb}	- 25 to + 85	°C
Power consumption	$T_{amb} \leq 85$ °C	P_{tot}	10	mW

Note

⁽¹⁾ Stresses beyond those listed under “Absolute Maximum Ratings” may cause permanent damage to the device. This is a stress rating only and functional operation of the device at these or any other conditions beyond those indicated in the operational sections of this specification is not implied. Exposure to absolute maximum rating conditions for extended periods may affect the device reliability.

ELECTRICAL AND OPTICAL CHARACTERISTICS ⁽¹⁾						
PARAMETER	TEST CONDITION	SYMBOL	MIN.	TYP.	MAX.	UNIT
Supply current (pin 3)	$E_v = 0, V_S = 5$ V	I_{SD}	0.65	0.85	1.05	mA
	$E_v = 40$ klx, sunlight	I_{SH}		0.95		mA
Supply voltage		V_S	2.7		5.5	V
Transmission distance	$E_v = 0$, test signal see fig. 1, IR diode TSAL6200, $I_F = 400$ mA	d		40		m
Output voltage low (pin 4)	$I_{OSL} = 0.5$ mA, $E_e = 0.7$ mW/m ² , test signal see fig. 1	V_{OSL}			100	mV
Minimum irradiance	Pulse width tolerance: $t_{pi} - 5/f_o < t_{po} < t_{pi} + 6/f_o$, test signal see fig. 1	E_e min.		0.3	0.45	mW/m ²
Maximum irradiance	$t_{pi} - 5/f_o < t_{po} < t_{pi} + 6/f_o$, test signal see fig. 1	E_e max.	30			W/m ²
Directivity	Angle of half transmission distance	$\varphi_{1/2}$		± 50		deg

Note

⁽¹⁾ $T_{amb} = 25$ °C, unless otherwise specified

TYPICAL CHARACTERISTICS

$T_{amb} = 25$ °C, unless otherwise specified

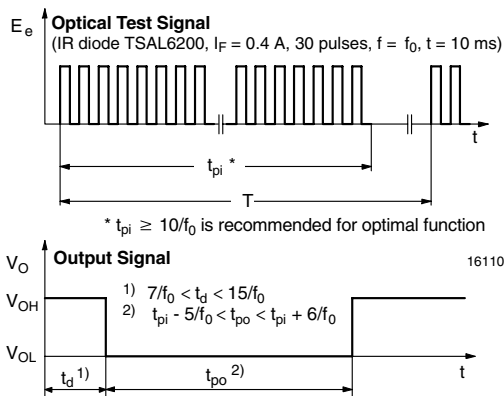

Fig. 1 - Output Active Low

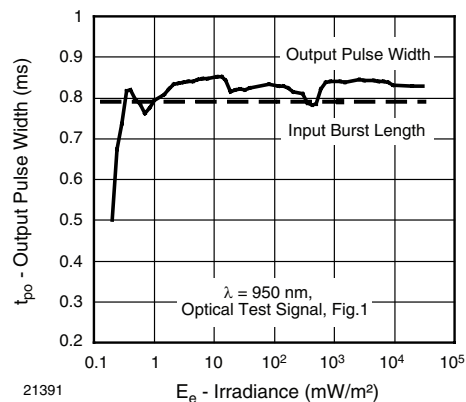

Fig. 2 - Pulse Length and Sensitivity in Dark Ambient

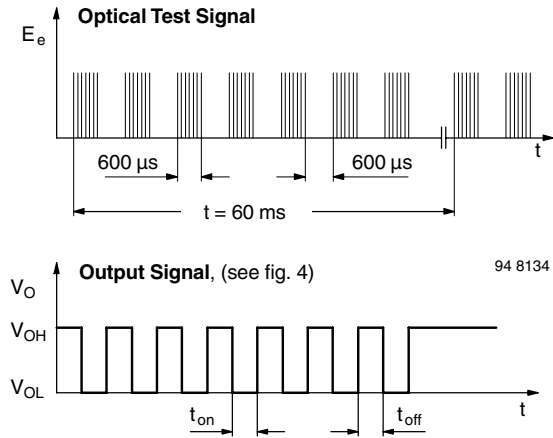

Fig. 3 - Output Function

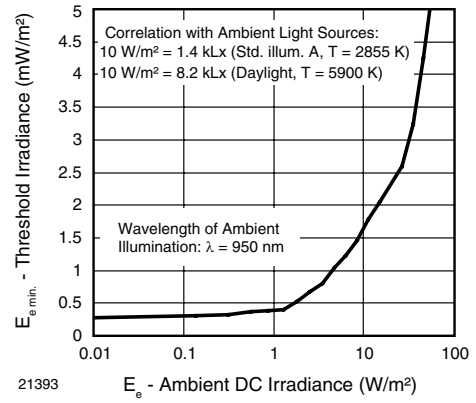

Fig. 6 - Sensitivity in Bright Ambient

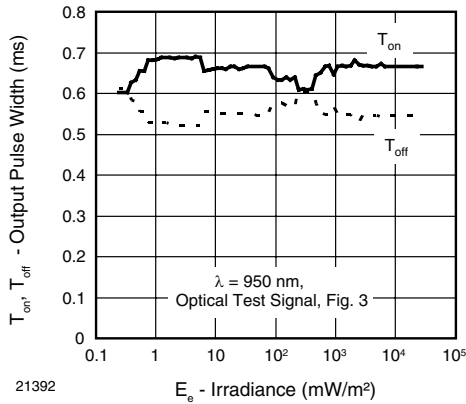

Fig. 4 - Output Pulse Diagram

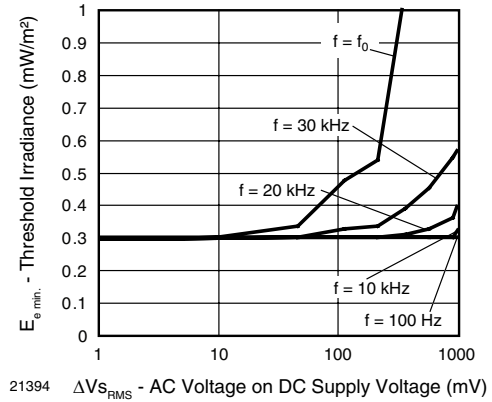

Fig. 7 - Sensitivity vs. Supply Voltage Disturbances

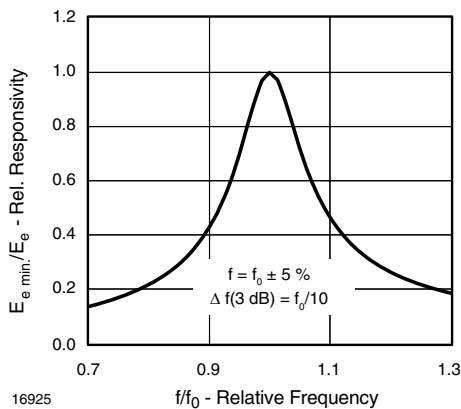

Fig. 5 - Frequency Dependence of Responsivity

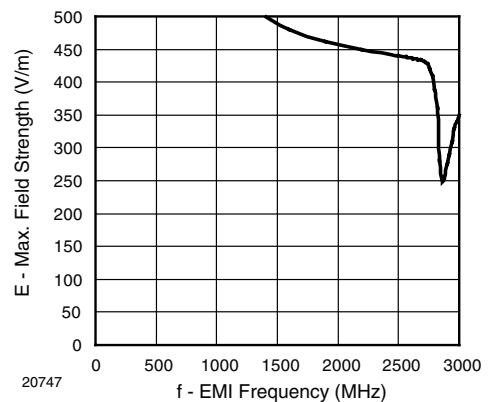
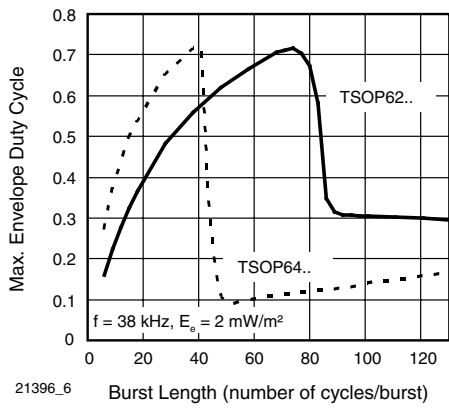
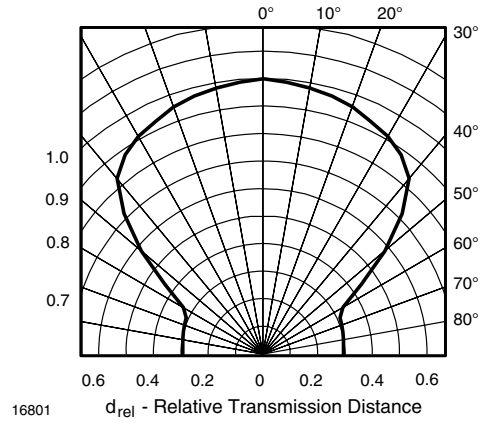

Fig. 8 - Sensitivity vs. Electric Field Disturbances



21396_6
Burst Length (number of cycles/burst)
Fig. 9 - Max. Envelope Duty Cycle vs. Burst Length



16801
 d_{rel} - Relative Transmission Distance
Fig. 12 - Horizontal Directivity

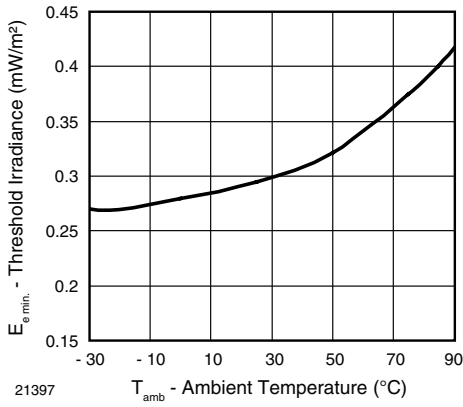

21397
 T_{amb} - Ambient Temperature ($^{\circ}\text{C}$)
Fig. 10 - Sensitivity vs. Ambient Temperature

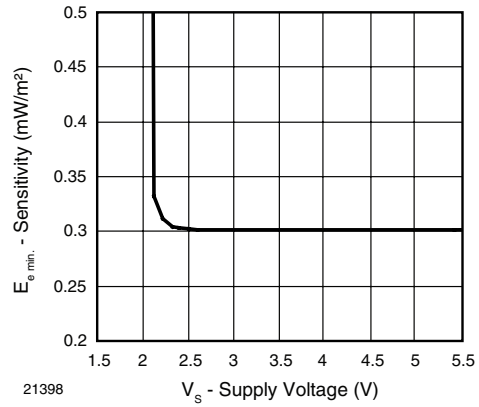

21398
 V_s - Supply Voltage (V)
Fig. 13 - Sensitivity vs. Supply Voltage

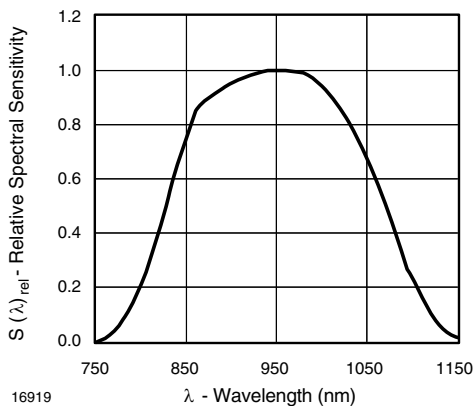

16919
 λ - Wavelength (nm)
Fig. 11 - Relative Spectral Sensitivity vs. Wavelength

SUITABLE DATA FORMAT

The TSOP62..., TSOP64.. series are designed to suppress spurious output pulses due to noise or disturbance signals. Data and disturbance signals can be distinguished by the devices according to carrier frequency, burst length and envelope duty cycle. The data signal should be close to the band-pass center frequency (e.g. 38 kHz) and fulfill the conditions in the table below.

When a data signal is applied to the TSOP62..., TSOP64.. in the presence of a disturbance signal, the sensitivity of the receiver is reduced to insure that no spurious pulses are present at the output. Some examples of disturbance signals which are suppressed are:

- DC light (e.g. from tungsten bulb or sunlight)
- Continuous signals at any frequency
- Strongly or weakly modulated noise from fluorescent lamps with electronic ballasts (see figure 14 or figure 15)

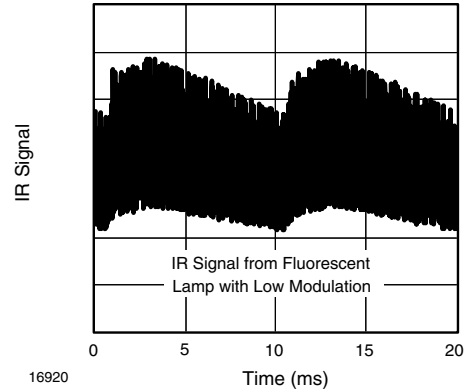

Fig. 14 - IR Signal from Fluorescent Lamp with Low Modulation

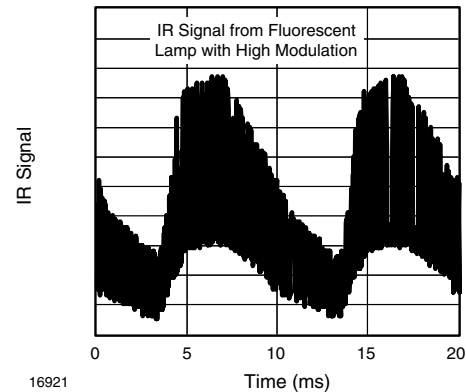

Fig. 15 - IR Signal from Fluorescent Lamp with High Modulation

	TSOP62..	TSOP64..
Minimum burst length	10 cycles/burst	10 cycles/burst
After each burst of length a minimum gap time is required of	10 to 70 cycles ≥ 12 cycles	10 to 35 cycles ≥ 12 cycles
For bursts greater than a minimum gap time in the data stream is needed of	70 cycles > 4 x burst length	35 cycles > 10 x burst length
Maximum number of continuous short bursts/second	800	1300
Recommended for NEC code	yes	yes
Recommended for RC5/RC6 code	yes	yes
Recommended for Sony code	yes	no
Recommended for Thomson 56 kHz code	yes	yes
Recommended for Mitsubishi code (38 kHz, preburst 8 ms, 16 bit)	yes	yes
Recommended for Sharp code	yes	yes
Suppression of interference from fluorescent lamps	Most common disturbance signals are suppressed	Even extreme disturbance signals are suppressed

Note

For data formats with short bursts please see the datasheet of TSOP61..., TSOP63..

New TSOP62..., TSOP64..

Vishay Semiconductors IR Receiver Modules for Remote Control Systems



PACKAGE DIMENSIONS in millimeters

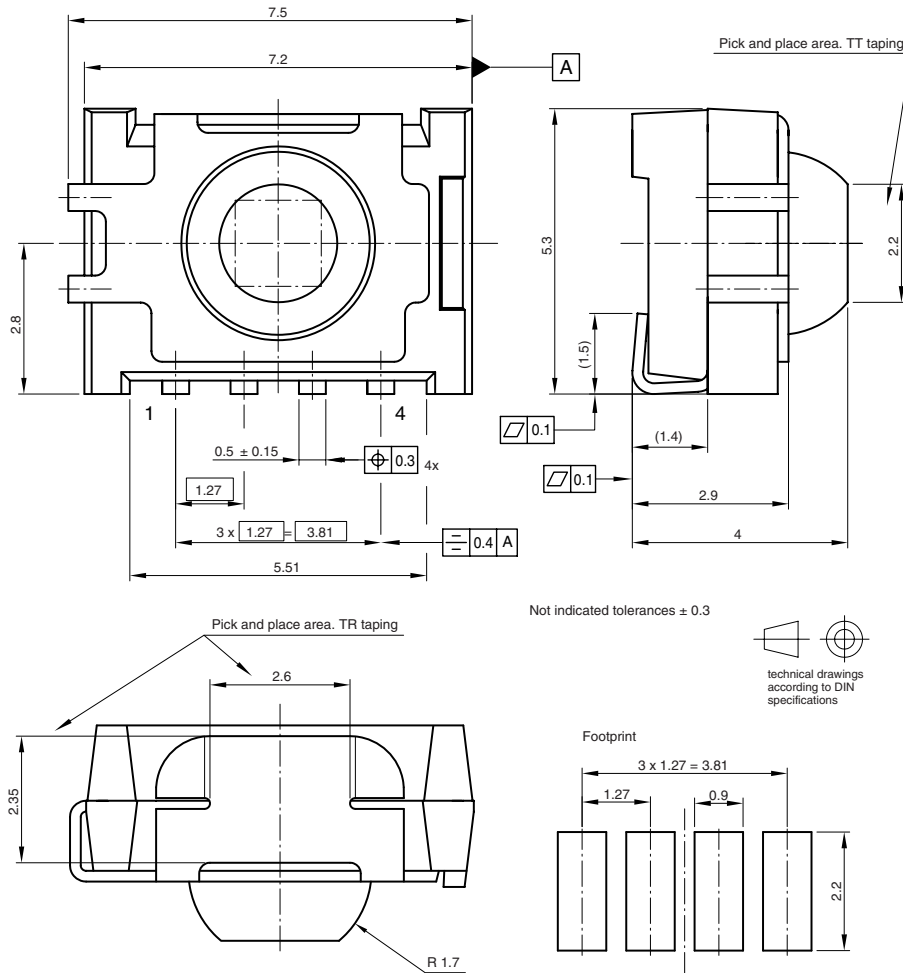

Drawing-No.: 6.544-5341.01-4
Issue: 8; 02.09.09
16776

ASSEMBLY INSTRUCTIONS

Reflow Soldering

- Reflow soldering must be done within 72 h while stored under a max. temperature of 30 °C, 60 % RH after opening the dry pack envelope
- Set the furnace temperatures for pre-heating and heating in accordance with the reflow temperature profile as shown in the diagram. Exercise extreme care to keep the maximum temperature below 260 °C. The temperature shown in the profile means the temperature at the device surface. Since there is a temperature difference between the component and the circuit board, it should be verified that the temperature of the device is accurately being measured
- Handling after reflow should be done only after the work surface has been cooled off

Manual Soldering

- Use a soldering iron of 25 W or less. Adjust the temperature of the soldering iron below 300 °C
- Finish soldering within 3 s
- Handle products only after the temperature has cooled off



VISHAY LEAD (Pb)-FREE REFLOW SOLDER PROFILE

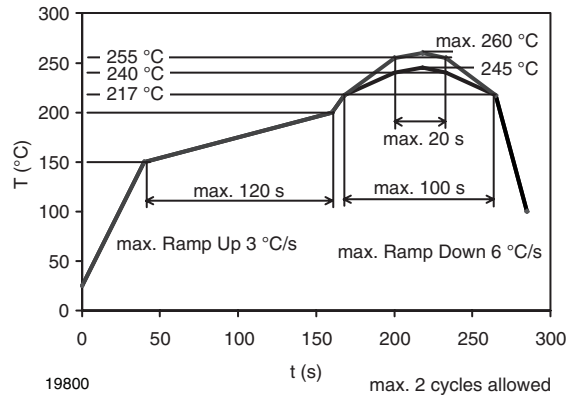

TAPING VERSION TSOP..TT Dimensions in millimeters

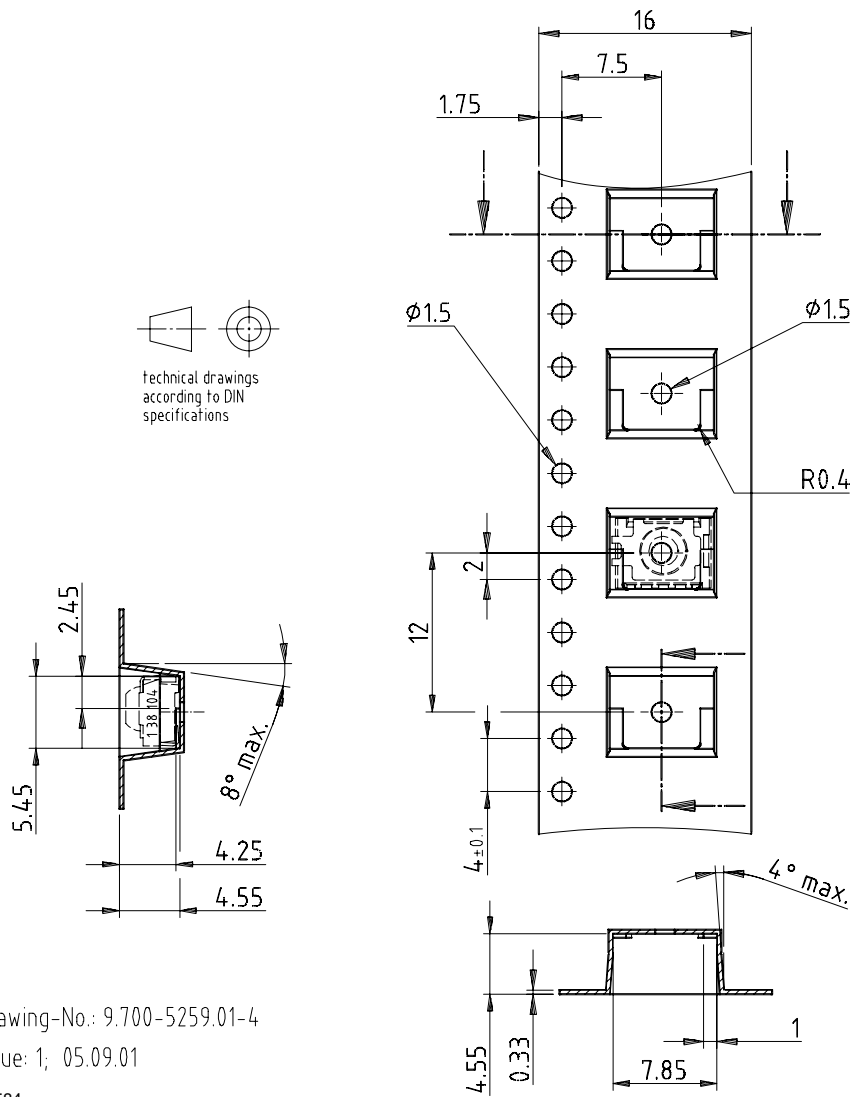

New TSOP62.., TSOP64..



Vishay Semiconductors IR Receiver Modules for Remote Control Systems

TAPING VERSION TSOP..TR Dimensions in millimeters

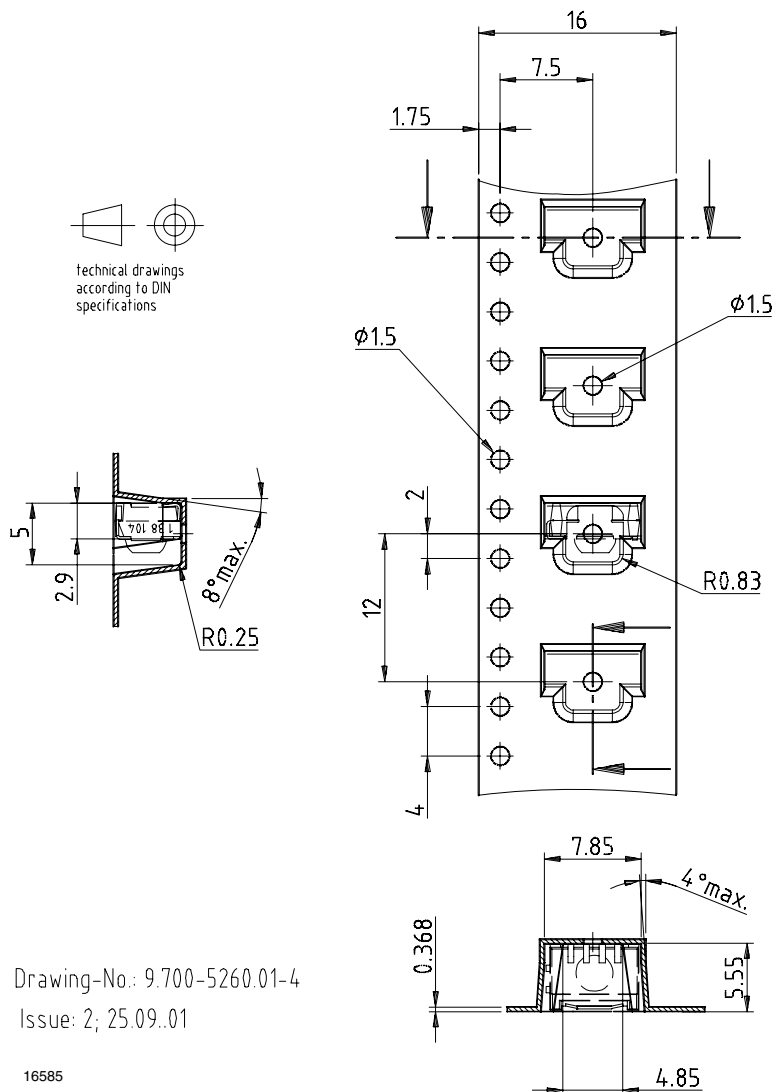

Drawing-No.: 9.700-5260.01-4

Issue: 2; 25.09.01

16585

REEL DIMENSIONS in millimeters

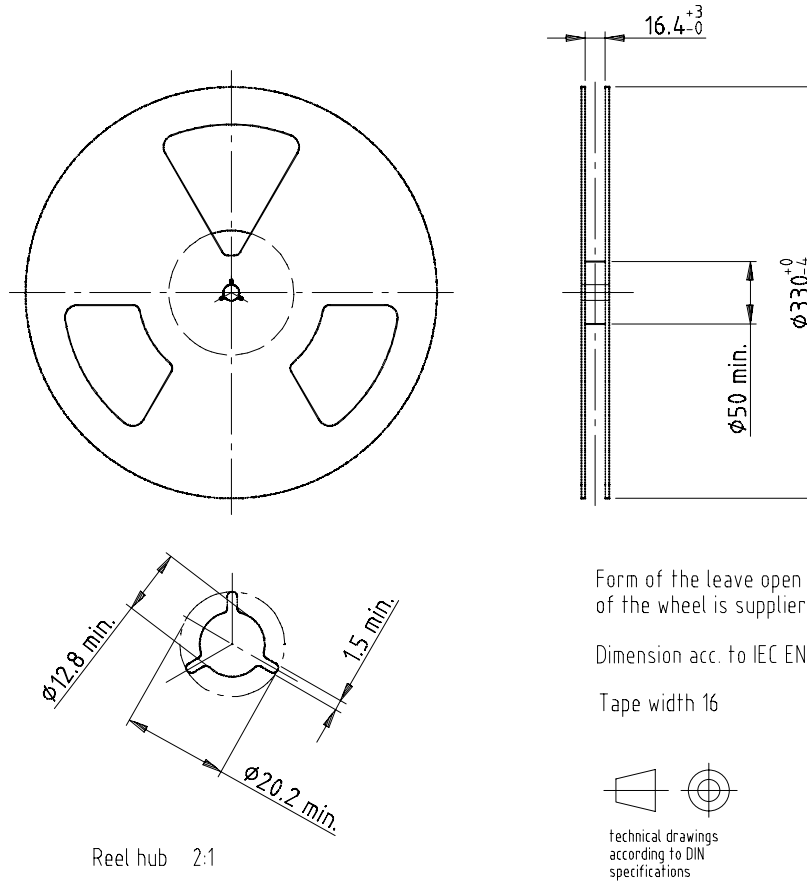

Form of the leave open of the wheel is supplier specific.

Dimension acc. to IEC EN 60 286-3

Tape width 16

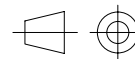

technical drawings according to DIN specifications

Drawing refers to following types: Reel for blister carrier tape Version B

Drawing-No.: 9.800-5052.V2-4

Issue: 1; 07.05.02

16734

LEADER AND TRAILER Dimensions in millimeters

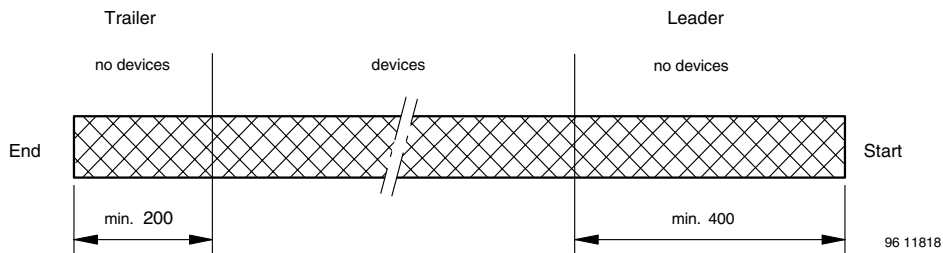

COVER TAPE PEEL STRENGTH

According to DIN EN 60286-3

0.1 N to 1.3 N

300 ± 10 mm/min.

165° to 180° peel angle

LABEL

Standard bar code labels for finished goods

The standard bar code labels are product labels and used for identification of goods. The finished goods are packed in final packing area. The standard packing units are labeled with standard bar code labels before transported as finished goods to warehouses. The labels are on each packing unit and contain Vishay Semiconductor GmbH specific data.

New TSOP62..., TSOP64..



Vishay Semiconductors IR Receiver Modules for Remote Control Systems

VISHAY SEMICONDUCTOR GMBH STANDARD BAR CODE PRODUCT LABEL (Finished Goods)		
PLAIN WRITING	ABBREVIATION	LENGTH
Item-description	-	18
Item-number	INO	8
Selection-code	SEL	3
LOT-/serial-number	BATCH	10
Data-code	COD	3 (YWW)
Plant-code	PTC	2
Quantity	QTY	8
Accepted by	ACC	-
Packed by	PCK	-
Mixed code indicator	MIXED CODE	-
Origin	xxxxxxx+	Company logo
LONG BAR CODE TOP	TYPE	LENGTH
Item-number	N	8
Plant-code	N	2
Sequence-number	X	3
Quantity	N	8
Total length	-	21
SHORT BAR CODE BOTTOM	TYPE	LENGTH
Selection-code	X	3
Data-code	N	3
Batch-number	X	10
Filter	-	1
Total length	-	17

DRY PACKING

The reel is packed in an anti-humidity bag to protect the devices from absorbing moisture during transportation and storage.

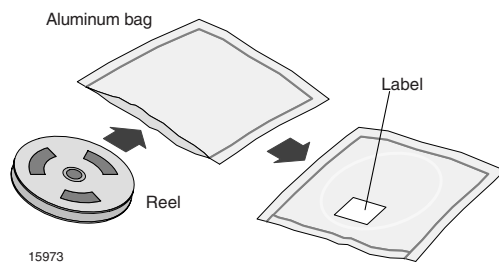

After more than 72 h under these conditions moisture content will be too high for reflow soldering. In case of moisture absorption, the devices will recover to the former condition by drying under the following condition:
 192 h at 40 °C + 5 °C/ - 0 °C and < 5 % RH (dry air/nitrogen) or
 96 h at 60 °C + 5 °C and < 5 % RH for all device containers or
 24 h at 125 °C + 5 °C not suitable for reel or tubes.
 An EIA JEDEC standard JESD22-A112 level 4 label is included on all dry bags.

FINAL PACKING

The sealed reel is packed into a cardboard box. A secondary cardboard box is used for shipping purposes.

RECOMMENDED METHOD OF STORAGE

Dry box storage is recommended as soon as the aluminum bag has been opened to prevent moisture absorption. The following conditions should be observed, if dry boxes are not available:

- Storage temperature 10 °C to 30 °C
- Storage humidity ≤ 60 % RH max.

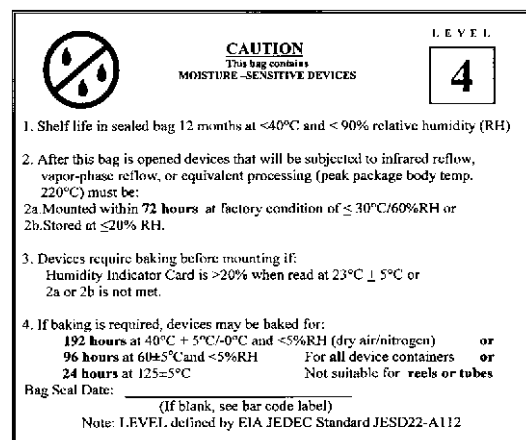

16943

Example of JESD22-A112 level 4 label



New TSOP62..., TSOP64..

IR Receiver Modules for
Remote Control Systems

Vishay Semiconductors

ESD PRECAUTION

Proper storage and handling procedures should be followed to prevent ESD damage to the devices especially when they are removed from the antistatic shielding bag. Electro-static sensitive devices warning labels are on the packaging.

VISHAY SEMICONDUCTORS STANDARD BAR CODE LABELS

The Vishay Semiconductors standard bar code labels are printed at final packing areas. The labels are on each packing unit and contain Vishay Semiconductors specific data.

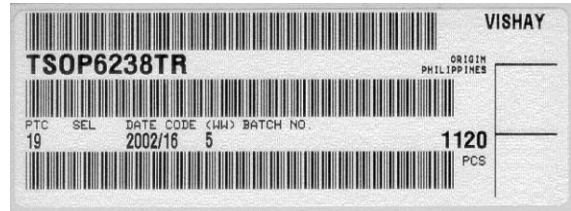

16962



Disclaimer

All product specifications and data are subject to change without notice.

Vishay Intertechnology, Inc., its affiliates, agents, and employees, and all persons acting on its or their behalf (collectively, "Vishay"), disclaim any and all liability for any errors, inaccuracies or incompleteness contained herein or in any other disclosure relating to any product.

Vishay disclaims any and all liability arising out of the use or application of any product described herein or of any information provided herein to the maximum extent permitted by law. The product specifications do not expand or otherwise modify Vishay's terms and conditions of purchase, including but not limited to the warranty expressed therein, which apply to these products.

No license, express or implied, by estoppel or otherwise, to any intellectual property rights is granted by this document or by any conduct of Vishay.

The products shown herein are not designed for use in medical, life-saving, or life-sustaining applications unless otherwise expressly indicated. Customers using or selling Vishay products not expressly indicated for use in such applications do so entirely at their own risk and agree to fully indemnify Vishay for any damages arising or resulting from such use or sale. Please contact authorized Vishay personnel to obtain written terms and conditions regarding products designed for such applications.

Product names and markings noted herein may be trademarks of their respective owners.