

Photointerrupter, Ultraminiature SMD type



Absolute maximum ratings (Ta=25°C)

Parameter	Symbol	Limits	Unit
Forward current	I _F	50	mA
Reverse voltage	V _R	5	V
Power dissipation	P _D	80	mW
Collector-emitter voltage	V _{CEO}	30	V
Emitter-collector voltage	V _{ECO}	4.5	V
Collector current	I _C	30	mA
Collector power dissipation	P _C	80	mW
Operating temperature	T _{opr}	-25 to +85	°C
Storage temperature	T _{stg}	-30 to +85	°C

Applications

DSC(Digital steal camera)
DVC(Digital video camera)
Digital handy phone

Features

- 1) Ultra-small.
- 2) Gap 1.2mm.

Electrical and optical characteristics (Ta=25°C)

Parameter	Symbol	Min.	Typ.	Max.	Unit	Conditions
Forward voltage	V _F	-	1.3	1.6	V	I _F =50mA
Reverse current	I _R	-	10	-	μA	V _R =5V
Dark current	I _{CEO}	-	0.5	-	μA	V _{CE} =10V
Peak sensitivity wavelength	λ _P	-	800	-	nm	-
Collector current	I _C	0.45	-	4.95	mA	V _{CE} =5V, I _F =20mA
Collector-emitter saturation voltage	V _{CE(sat)}	-	-	0.4	V	I _F =20mA, I _C =0.1mA
Response time	Rise time	t _r	10	-	μs	V _{CC} =5V, I _F =20mA, R _L =100Ω
	Fall time	t _f	10	-	μs	
Collector rank	A	I _C	0.45	2.33	mA	V _{CE} =5V, I _F =20mA
	B	I _C	0.95	4.95	mA	
Cut-off frequency	f _c	-	1	-	MHz	I _F =50mA * Non-coherent Infrared light emitting diode used.
Peak light emitting wavelength	λ _P	-	950	-	nm	-
Response time	t _r ·t _f	-	10	-	μs	V _{CC} =5V, I _C =1mA, R _L =100Ω * This product is not designed to be protected against electromagnetic wave.
	Maximum sensitivity wavelength	λ _P	-	800	nm	

Electrical and optical characteristics curves

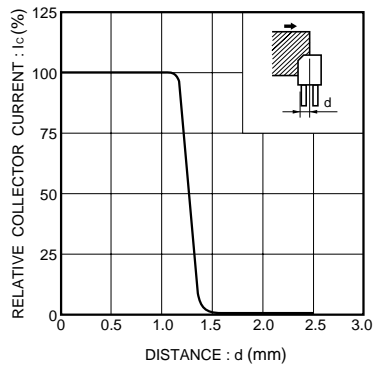

Fig.1 Relative output current vs. distance (I)

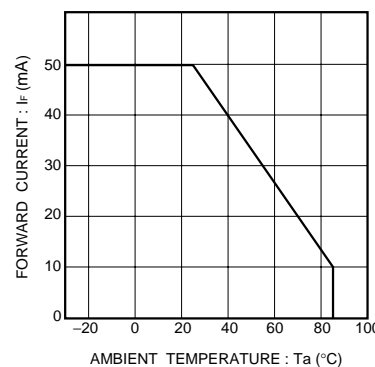

Fig.2 Forward current falloff

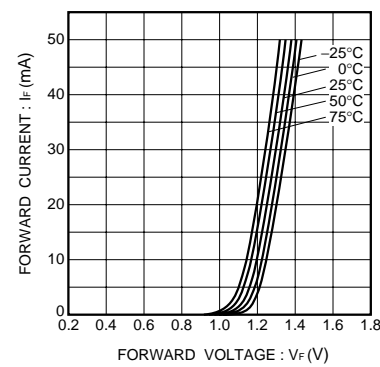

Fig.3 Forward current vs. forward voltage

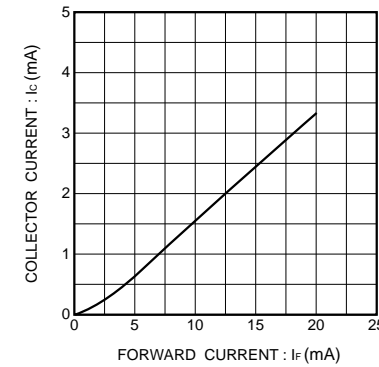

Fig.7 Collector current vs. forward current

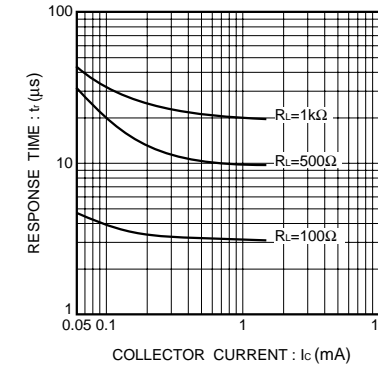

Fig.8 Response time vs. collector current

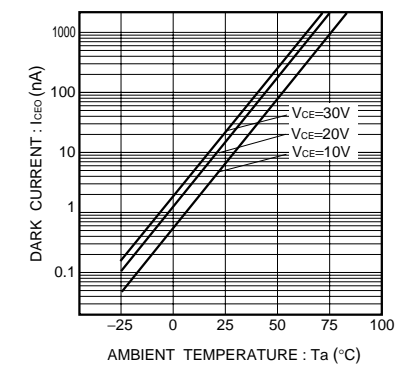

Fig.9 Dark current vs. ambient temperature

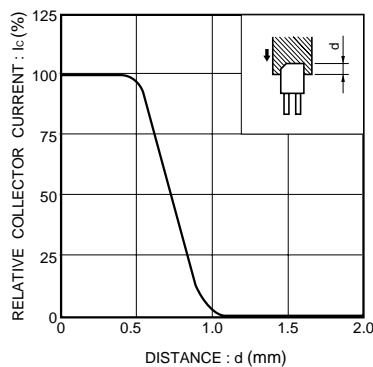

Fig.4 Relative output current vs. distance (II)

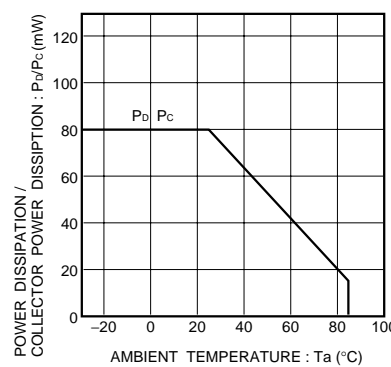

Fig.5 Power dissipation / collector power dissipation vs. ambient temperature

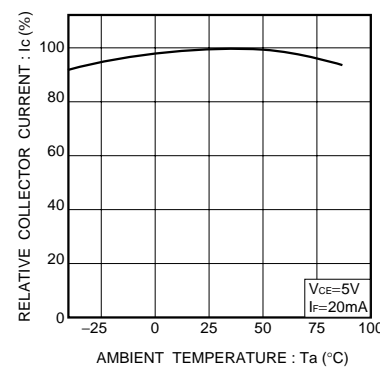

Fig.6 Relative output vs. ambient temperature

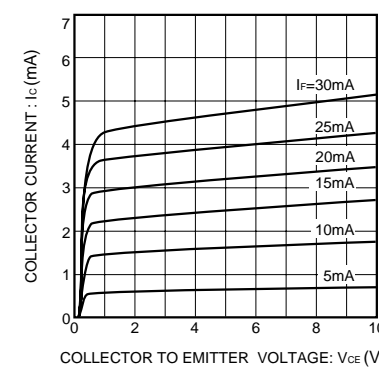

Fig.10 Output characteristics

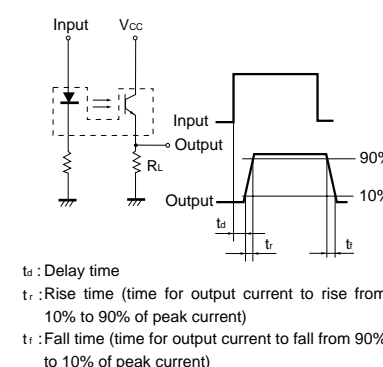
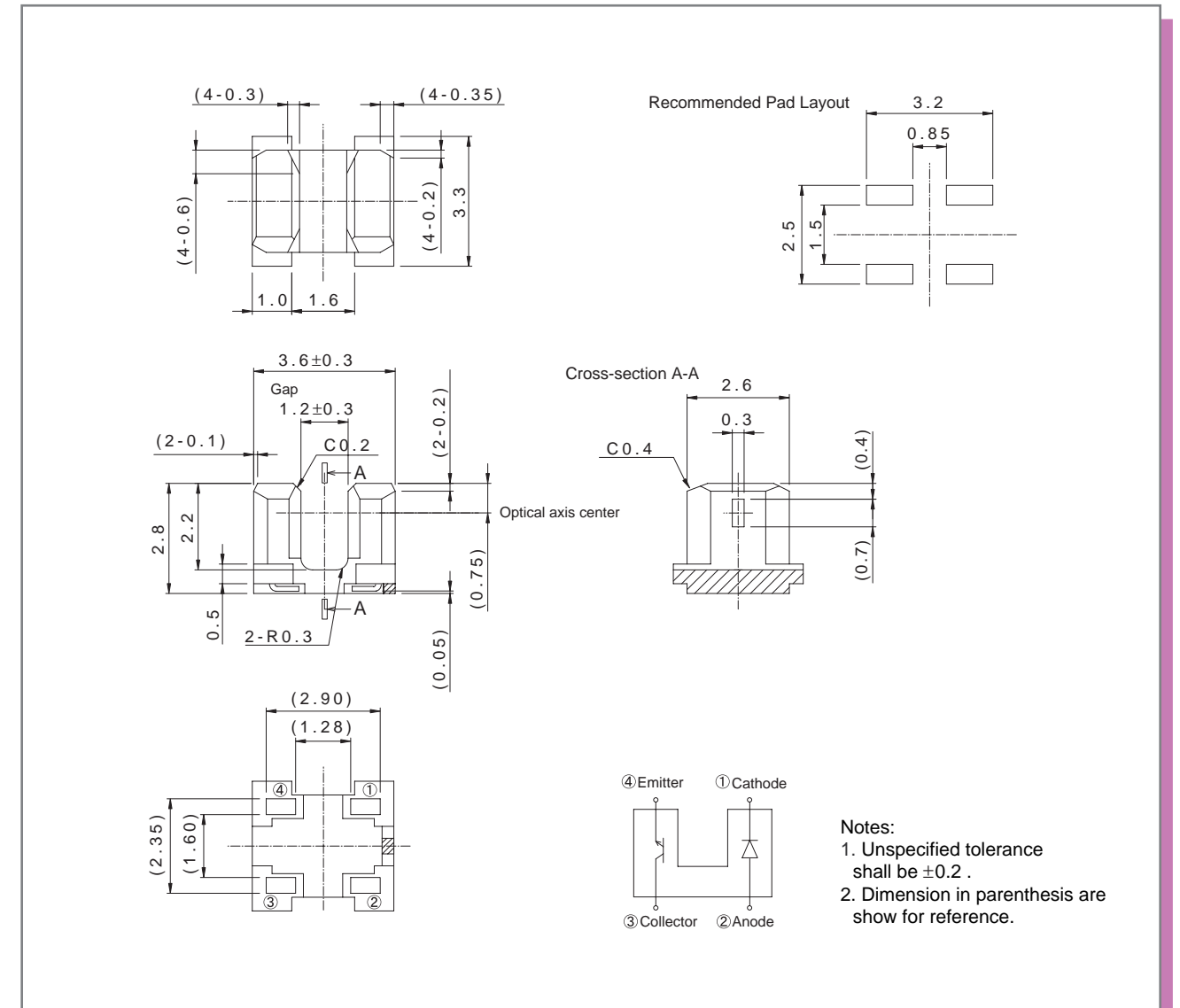

Fig.11 Response time measurement circuit

External dimensions (Unit : mm)



Notes:
1. Unspecified tolerance shall be ±0.2.
2. Dimension in parenthesis are show for reference.

Notes

- No technical content pages of this document may be reproduced in any form or transmitted by any means without prior permission of ROHM CO.,LTD.
- The contents described herein are subject to change without notice. The specifications for the product described in this document are for reference only. Upon actual use, therefore, please request that specifications to be separately delivered.
- Application circuit diagrams and circuit constants contained herein are shown as examples of standard use and operation. Please pay careful attention to the peripheral conditions when designing circuits and deciding upon circuit constants in the set.
- Any data, including, but not limited to application circuit diagrams information, described herein are intended only as illustrations of such devices and not as the specifications for such devices. ROHM CO.,LTD. disclaims any warranty that any use of such devices shall be free from infringement of any third party's intellectual property rights or other proprietary rights, and further, assumes no liability of whatsoever nature in the event of any such infringement, or arising from or connected with or related to the use of such devices.
- Upon the sale of any such devices, other than for buyer's right to use such devices itself, resell or otherwise dispose of the same, no express or implied right or license to practice or commercially exploit any intellectual property rights or other proprietary rights owned or controlled by
- ROHM CO., LTD. is granted to any such buyer.
- Products listed in this document are no antiradiation design.

The products listed in this document are designed to be used with ordinary electronic equipment or devices (such as audio visual equipment, office-automation equipment, communications devices, electrical appliances and electronic toys).

Should you intend to use these products with equipment or devices which require an extremely high level of reliability and the malfunction of which would directly endanger human life (such as medical instruments, transportation equipment, aerospace machinery, nuclear-reactor controllers, fuel controllers and other safety devices), please be sure to consult with our sales representative in advance.

About Export Control Order in Japan

Products described herein are the objects of controlled goods in Annex 1 (Item 16) of Export Trade Control Order in Japan.

In case of export from Japan, please confirm if it applies to "objective" criteria or an "informed" (by MITI clause) on the basis of "catch all controls for Non-Proliferation of Weapons of Mass Destruction.