



FEATURES

- RoHS compliant
- Radial format
- Up to 1.62A I_{DC}
- 10µH to 68mH
- Low DC resistance
- Miniature size
- PCB mounting
- MIL-I-23053/5 class I sleeving
- Fully tinned leads
- Supplied in bags of 100
- Compatible with RoHS soldering systems
- Backward compatible with Sn/Pb soldering systems
- Custom parts available

DESCRIPTION

The 2200R Series is a general purpose range of inductors suitable for low to medium current applications. Their small footprint makes them ideal for high density applications where a chip inductor will not cope with the power requirement.

SELECTION GUIDE

Order Code	Inductance, (1kHz, 0.1V _{AC})	DC Current ¹	DC Resistance	Q at f kHz		SRF
	±10%	Max.	Max.	Nom.		Nom.
	µH	A	Ω	Q	f	MHz
22R103C	10.0	1.62	0.05	40	1000	21.2
22R153C	15.0	1.35	0.07	30	500	19.4
22R223C	22.0	1.08	0.09	30	500	17.0
22R333C	33.0	0.90	0.14	25	500	11.4
22R473C	47.0	0.77	0.22	25	500	10.9
22R683C	68.0	0.77	0.28	70	100	10.6
22R104C	100.0	0.67	0.39	65	100	8.9
22R154C	150.0	0.52	0.54	80	100	6.2
22R224C	220.0	0.43	0.83	90	100	5.4
22R334C	330.0	0.38	1.21	95	100	4.5
22R474C	470.0	0.31	1.65	100	100	3.2
22R684C	680.0	0.25	2.64	105	100	3.0
22R105C	1.0mH	0.17	3.63	120	100	2.5
22R155C	1.5mH	0.13	6.49	130	100	2.1
22R225C	2.2mH	0.11	8.58	130	50	1.9
22R335C	3.3mH	0.10	10.0	125	150	1.2
22R475C	4.7mH	0.081	13.2	130	150	0.95
22R685C	6.8mH	0.072	22.0	135	150	0.85
22R106C	10.0mH	0.063	37.4	140	150	0.62
22R156C	15.0mH	0.054	49.5	145	150	0.51
22R226C	22.0mH	0.045	82.5	100	50	0.34
22R336C	33.0mH	0.036	110.0	90	50	0.28
22R476C	47.0mH	0.027	154.0	80	50	0.25
22R686C	68.0mH	0.018	242.0	70	50	0.20

TYPICAL CORE/WIRE CHARACTERISTICS

Inductance Temperature Coefficient	Resistance Temperature Coefficient	Curie Temperature (T _c)	Saturation Flux (B _{SAT})
350ppm	3900ppm	190°C	325mT

ABSOLUTE MAXIMUM RATINGS

Operating free air temperature range	-25°C to 70°C
Storage temperature range	-40°C to 125°C

SOLDERING INFORMATION²

Peak wave solder temperature	300°C for 10 seconds
Pin finish	Hot dipped tin

All specifications typical at T_a=25°C

- 1 Maximum DC current occurs when either the inductance falls to 90% of its nominal value or when its temperature rise reaches 30°C, whichever is sooner.
- 2 For further information, please visit www.murata-ps.com/rohs



PACKAGE SPECIFICATIONS

MECHANICAL DIMENSIONS

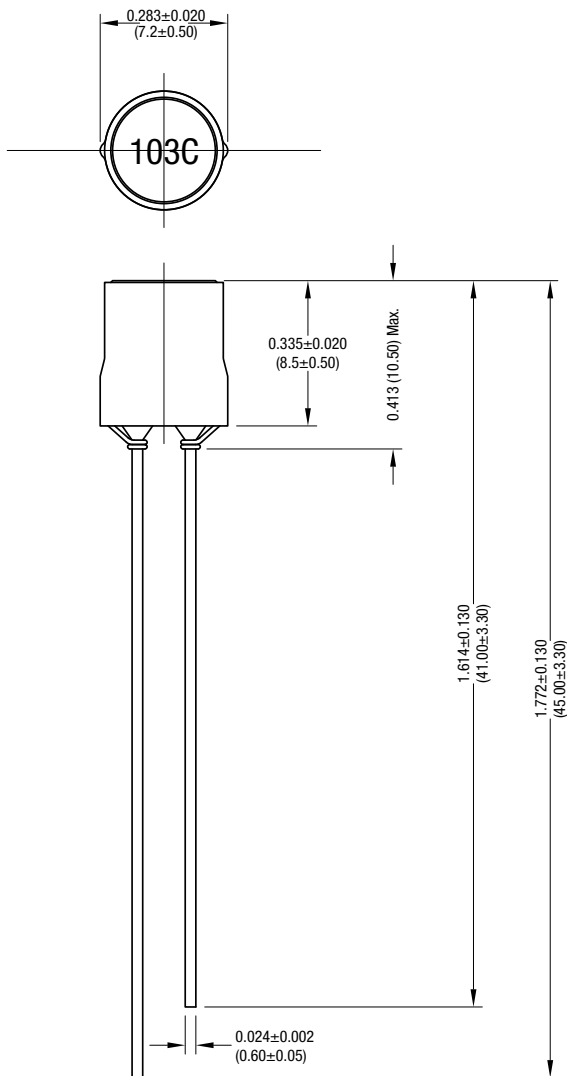

All dimensions in inches (mm). Package weight 1.3g Typ.

RECOMMENDED FOOTPRINT DETAILS

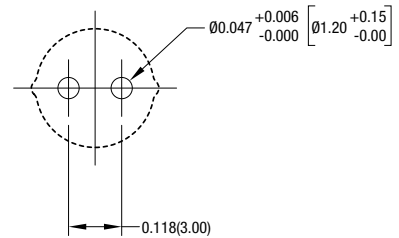

All dimensions in inches (mm)