

Illuminated switches, pushbutton switches for front panel mounting

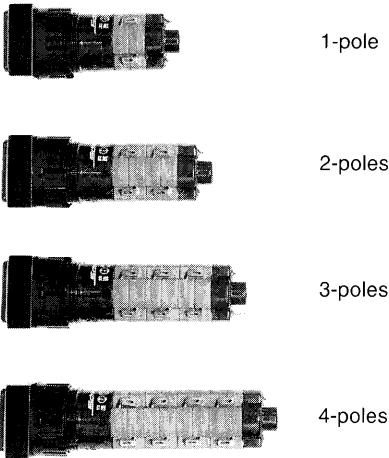

Standards and approvals
SEV 1005, VDE 0630, SEMKO 124, CSA C22.2/14
UL 508, CEE 24

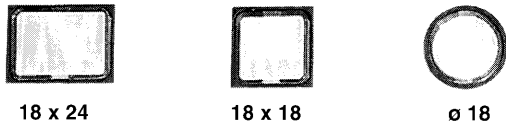

General description

The **S10** is a complete programme of illuminated pushbutton switches for front panel mounting (panel cutout 16 mm dia).

Lenses are available in the following forms: rectangular 18 x 24 mm, square 18 x 18 mm and round 18 mm dia.

The standard design protects the front of the switches against accidental operation.

The pushbutton switches can be fitted with a device to prevent accidental twisting. The switches have snap action elements and are available with 1–4 contact blocks.

Gold-plated contacts are standard and are suitable for both, low-current use and standard applications.

Each contact block can be used as N/C or N/O or change-over contact (for change-over contact ext. connection between terminals 2 and 4).

Contacts in one section must have the same polarity.

The 4 tin-plated terminals of each block are absolutely flux-proof.

The lenses of the S10 range are available in 11 different colours and can be illuminated either by midget-groove T 1³/₄ incandescent lamps or LED's.

The switching positions of the alternate version of the pushbutton switches are always indicated by the position of the lens.

When using neon lamps with external resistor ≤ 250 V~, please consider relevant standards and approvals.

Approvals:

SEV-Approval	No. 95.551978.02	UL-Recognition	No. E 172884
VDE-Certificate	No. 93285 ÜG	CSA-Certification	No. LR 96746-2
SEMKO-Approval	No. 9544108 01		

Technical data

Switch system

each contact block has one double break, snap acting switching mechanism

Switch mode

momentary or alternate action, 1- to 4-poles

Contact material

silver/nickel gold-plated (hard-gold)

Operating travel

3.2 mm

Actuating force

> 1.5 N

Initial contact resistance (new)

< 10 mΩ

Breaking capacity (at ohmic load)

250 V / 5 A AC,
250 V / 0,2 A DC

Mechanical lifetime

> 2 x 10⁶ operations

Electrical lifetime (at ohmic load)

5 A / 250 V AC

> 50 000 operations

4 A / 250 V AC

> 60 000 operations

2 A / 250 V AC

> 200 000 operations

1 A / 250 V AC

> 400 000 operations

Storage temperature

–40 °C up to +85 °C

Operating temperature

–40 °C up to +55 °C (with incandescent lamp)
–40 °C up to +85 °C (without incandescent lamp)

Vibration resistance

IEC 68-2-6 test Fc, details on request

Insulation resistance

> 10⁴ MΩ 500 V DC according to IEC 341-1

Test voltage

> 4000 V, 50 Hz, 1 min between metal plate and terminals

Protection class

suitable for mounting in equipments with protection class II/IEC 536

Degree of protection

IP40 IEC 529 (front; when mounted)
IP67 (with splash guard)

Climate category

GVF with lamp, GPF without lamp according to DIN 40040

Terminals

Max. diameter of wire 2 x 0.8 mm²
Max. diameter of stranded cable 0,75 mm²

Solderability

350 °C, 2 s, IEC 68-2-20, test Ta, method 2

Soldering heat resistance

350 °C, 10 s, IEC 68-2-20, test Tb, method 2

Materials

temperature resistant thermoplastic, contact housing moulded in electrical high-grade thermosetting plastic
current-carrying parts: Cu-alloys

Availability: ex warehouse or prompt delivery

Illuminated switches pushbutton switches

Case colour black

Standards and approvals
SEV 1005, VDE 0630, SEMKO 124, CSA C22.2/14
UL 508, CEE 24

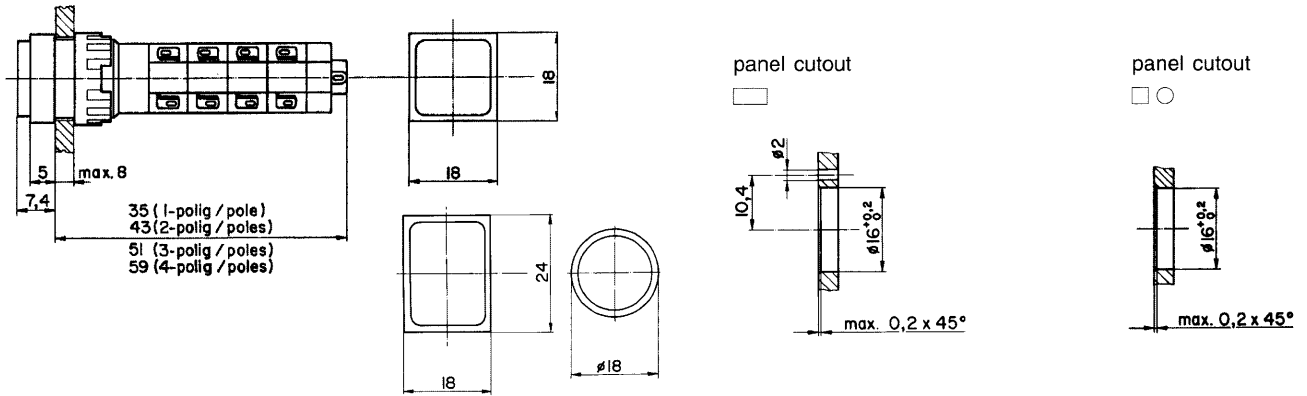
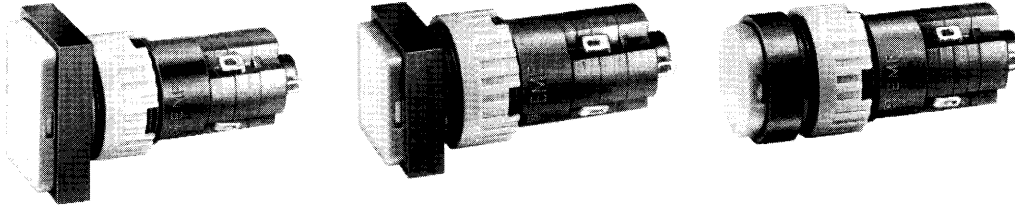

Order No. for S10 without lenses, lamps etc., accessories see page 5-7

Description	Type	Type	Contact diagram (button not depressed) for change-over contact ext. connections between 2 and 4	Length A [mm]	Order No. Shape of case		
					□ 18 x 24	□ 18 x 18	○ ø 18
Illuminated pushbutton 1-pole, momentary action	1			35	0041.2301	0041.2311	0041.2321
Illuminated pushbutton 2-pole, momentary action	2			43	0041.2302	0041.2312	0041.2322
Illuminated pushbutton 3-pole, momentary action	3			51	0041.2303	0041.2313	0041.2323
Illuminated pushbutton 4-pole, momentary action	4			59	0041.2304	0041.2314	0041.2324
Illuminated pushbutton 1-pole, alternate action		1		35	0041.2351	0041.2361	0041.2371
Illuminated pushbutton 2-pole, alternate action		2		43	0041.2352	0041.2362	0041.2372
Illuminated pushbutton 3-pole, alternate action		3		51	0041.2353	0041.2363	0041.2373
Illuminated pushbutton 4-pole, alternate action		4		59	0041.2354	0041.2364	0041.2374

Contacts in one section must be same polarity

Availability: ex warehouse or prompt delivery

Signal lamps for panel mounting

Standards and approvals
SEV 1060, VDE 0710, SEMKO 103, UL 508, CSA C 22.2-14

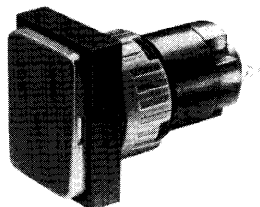
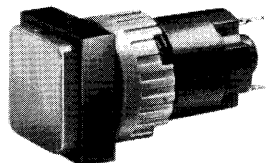
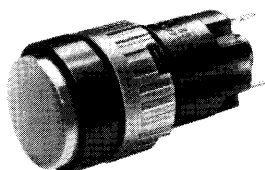

- Holders **S10** for interchangeable incandescent lamps and LED's (T1³/₄ Midget Groove)
- Available for voltages 6.3 V, 14 V, 28 V, 48 V and 60 V
- Technical data of incandescent and LED's see page 5
- Case colour black
- Combination terminals for solder or PCB mounting
- Accessories for lamp holders have to be ordered separately.

- Approvals:

SEV-Approval	No. 91.550698.01
VDE-Mark	No. 42343
SEMKO-Approval	No. 8410021
UL-Recognition	No. E 73407
CSA-Certification	No. LR 47016

Technical data

Lamp holder	incandescent lamp 1,2 W or LED T 1 ³ / ₄ Midget-Groove
Mounting	front panel or PCB
Mounting hole	16,2 mm
Connections	combination of soldering and PCB version 0,7 x 0,5 mm
Material	body: thermoplastic resistant of temperature current-carrying parts, CU-alloy
Degree of protection	IP40 (mounted from the front side)
Storage temperature	- 55 ... + 100 °C
Operating temperature	- 25 ... + 85 °C
Solderability	350 °C, 2 s, IEC 68-2-20, test ta method 2
Soldering heat resistance	350 °C, 10 s, IEC 68-2-20, test tb method 2



Panel cutout



Panel cutout

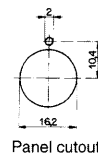
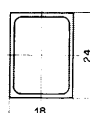

Panel cutout

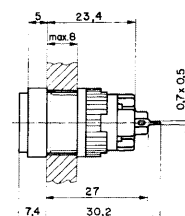

Terminals



Order No.

Socket \varnothing 18 mm Socket \square 18 x 18 mm
0035.5521 0035.5511

Order No.

Socket \square 18 x 24 mm
0035.5501

Alarm buzzer

for front panel mounting

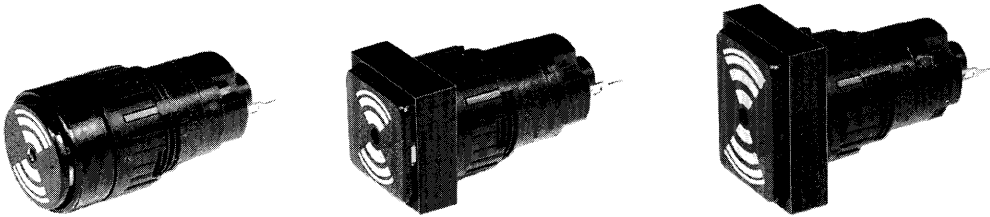

- Acoustic alarm with front dimensions
- Available for voltages 6 V, 12 V, and 24 V
- Lens standard black with white legend

○ 18 □ 18 x 18 □ 18 x 24

Technical data

Operating voltage	6 V, 12 V, 24 V (AC/DC) +/-10%
Operating current	13 mA
Pole-reversal protection	yes
Sound level	84 dB at 0,1 m
Sound frequency	DC: 2300 Hz / AC: power system
Mounting	front panel or PCB
Panel cutout	16 mm
Terminals	combined solder-/PCB terminals 0,7 x 0,5 mm
Materials	body: temperature resistant thermoplastic current-carrying parts: Cu-alloys
Degree of protection	IP40 IEC 529 (front; when mounted) IP67 (with splash guard; sound level < 84 dB)
Storage temperature	- 55 ... + 100 °C
Ambient operating temperature	- 25 ... + 85 °C
Solderability	350 °C, 2 s, IEC 68-2-20, test Ta method 2
Soldering heat resistance	350 °C, 10 s, IEC 68-2-20, test Tb method 2

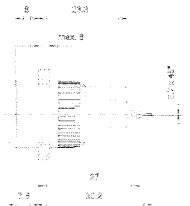
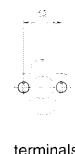
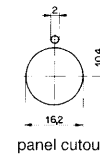
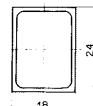
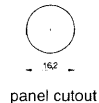
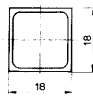
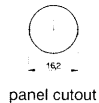
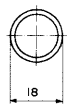

Order No.

Socket	ø 18 mm	Socket	□ 18 x 18 mm
0035.5206	6 V	0035.5106	6 V
0035.5212	12 V	0035.5112	12 V
0035.5224	24 V	0035.5124	24 V

Order No.

Socket	□ 18 x 24 mm
0035.5006	6 V
0035.5012	12 V
0035.5024	24 V

Availability: ex warehouse or prompt delivery

Accessories S10

Flush mounting bezel

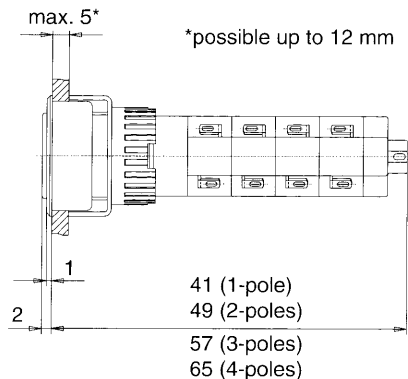
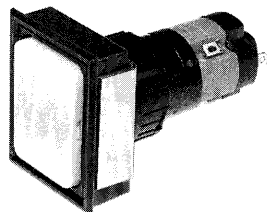

Flush mounting bezel incl. fixing clamp

Fixing clamp (single)

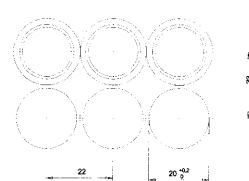
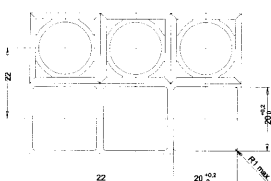
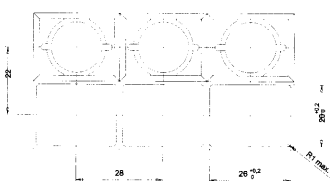
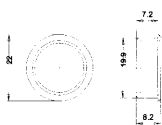
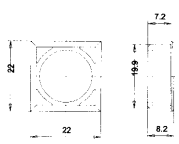
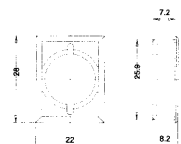
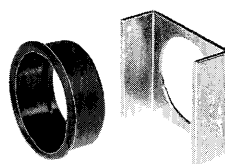
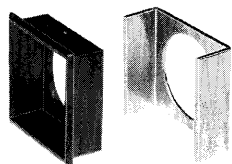
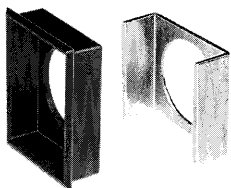

panel cutout

panel cutout

panel cutout

Order No.

0886.0017

0886.0018

Order No.

0886.0019

0886.0016

□ 18 x 24

□ 18 x 18

○ 18

Anti-twisting plate

Insulating boot (black)

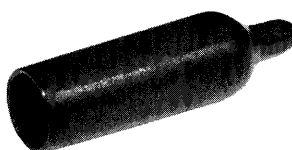

Order No.

0886.0030

Order No.

0859.0081

Availability: ex warehouse or prompt delivery

Accessories S10

Flush mounting bezel

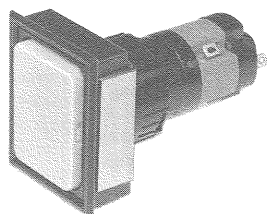

Flush mounting bezel incl. fixing clamp

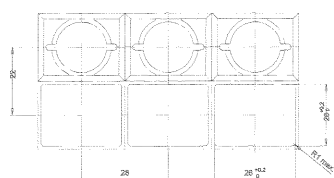
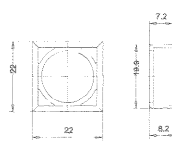
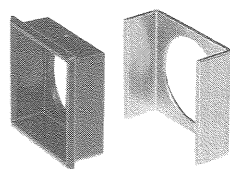
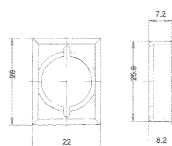
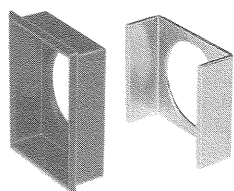

panel cutout

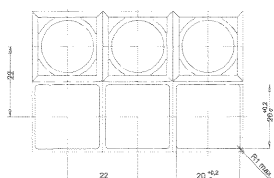

panel cutout

Order No.

0886.0017

0886.0018

18 x 24

18 x 18

Anti-twisting plate



Order No.

0886.0030

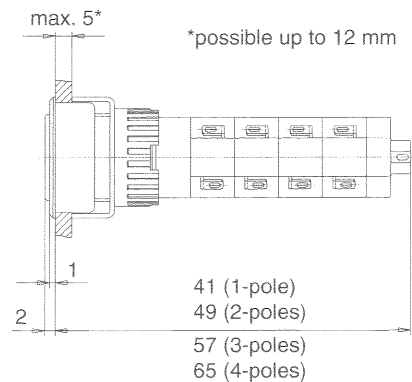
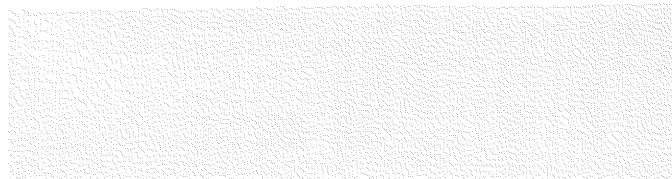

Fixing clamp (single)

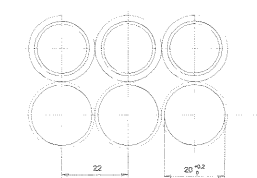
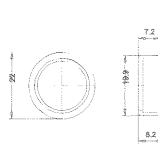
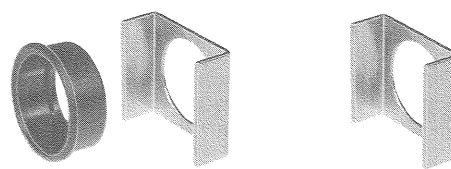

panel cutout

Order No.

0886.0019

0886.0016

18

Insulating boot (black)

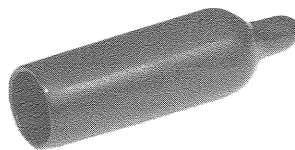

Order No.

0859.0081

Availability: ex warehouse or prompt delivery

Accessories S10

Incandescent lamps

LED's

Mounting tools

Incandescent lamp T 1³/₄ Midget Groove



Order No.

	voltage	consumption	brightness	lifetime	
				AC	DC
0913.4001	6.3 V	200 mA	.40 MSCP	50'000 h	25'000 h
0913.4002	14 V	80 mA	.20 MSCP	15'000 h	7'000 h
0913.4003	28 V	40 mA	.20 MSCP	10'000 h	5'000 h
0913.4004	48 V	25 mA	.20 MSCP	5'000 h	2'000 h
0913.4005	60 V	20 mA	.30 MSCP	1'000 h	1'000 h
0913.4006	24 V	50 mA	.18 MSCP	10'000 h	5'000 h

The use of incandescent lamps > 60 V is limited by different standards.

Series resistors for incandescent lamps and capacitors for the reduction of lamp voltage available on request. The permission for other ratings must be clarified according to the international testing laboratories. Incandescent lamps with lower power consumption on request.

LED T 1³/₄ Midget Groove

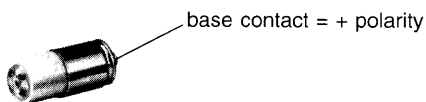

Order No.

	Operating voltage U_B [V]	Reverse voltage U_R [V]	Operating current I_F [mA]	Operating temperat. °C	Storage temperat. °C	Power dissipation P_{tot} [mW]	Peak wave length λ_{peak} [nm]	Reverse current I_R [µA]	Lumin. intensity I_v [mcd]
0925.0104 red	6	8	30	-25 °C up to +70 °C	-25 °C up to +85 °C	250	700	100	7
0925.0105 green	6	8	30			250	555	100	30
0925.0106 yellow	6	8	30			250	570	100	22
0925.0107 red	12	16	15			250	700	100	7
0925.0108 green	12	16	15			250	555	100	30
0925.0109 yellow	12	16	15			250	570	100	22
0925.0110 red	28	16	10			300	700	100	7
0925.0111 green	28	16	10			300	555	100	30
0925.0112 yellow	28	16	10			300	570	100	22

Lamp extractor

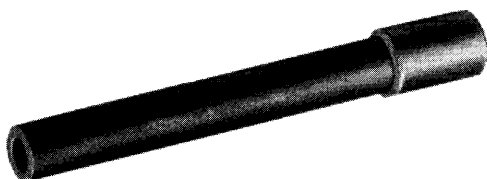

Order No.

0853.0621

Mounting key

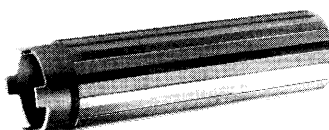

Order No.

0853.0622

Availability: ex warehouse or prompt delivery

Accessories S10

Protection shields

Protection shield against inadvertent operation (thermoplastic)

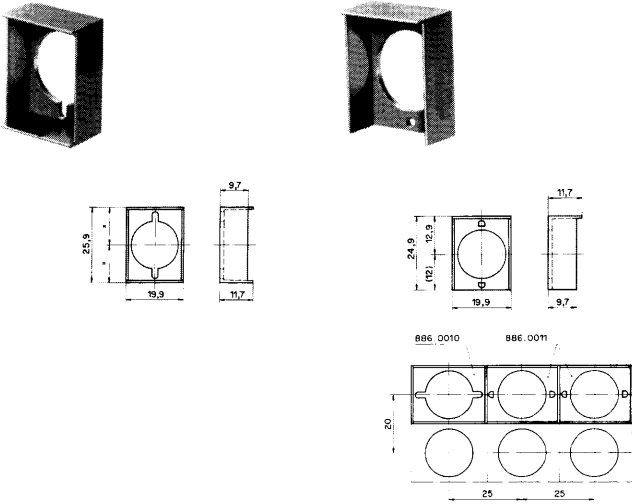

Order No.

0886.0010 single mounting

0886.0011 in-line mounting

Splash guards IP64 (PVC)

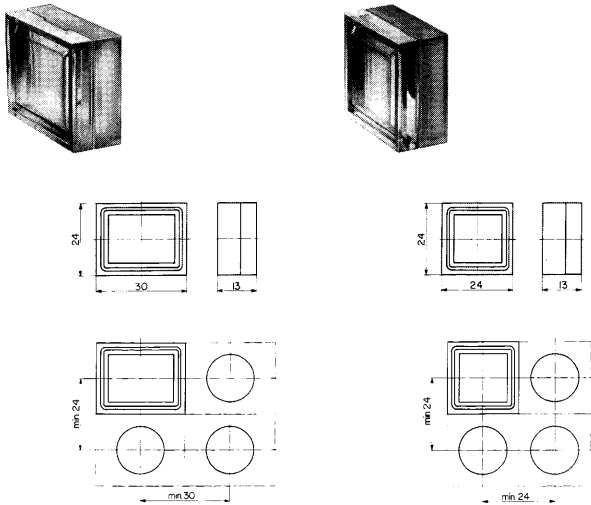

Order No.

0886.0002

0886.0001

Blanking plate black

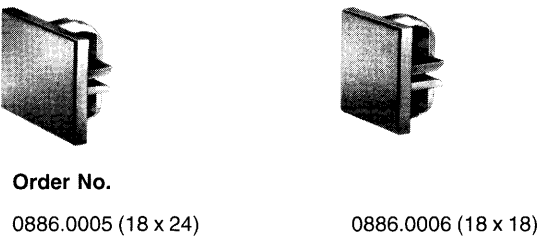

Order No.

0886.0005 (18 x 24)

0886.0006 (18 x 18)

Protection shield against inadvertent operation

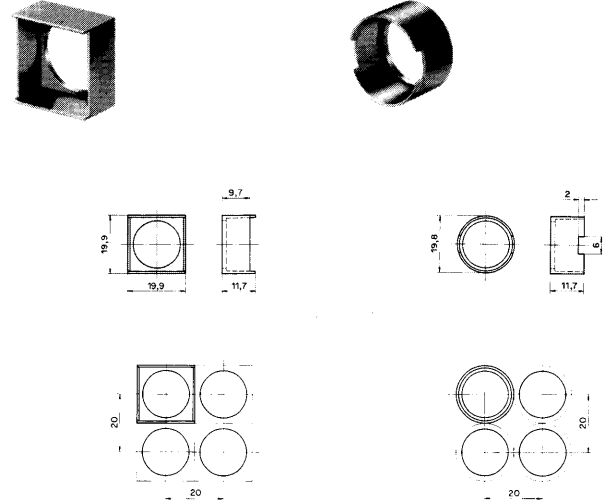

Order No.

0886.0012

0886.0013

Protection cap (lockable with lead seal)

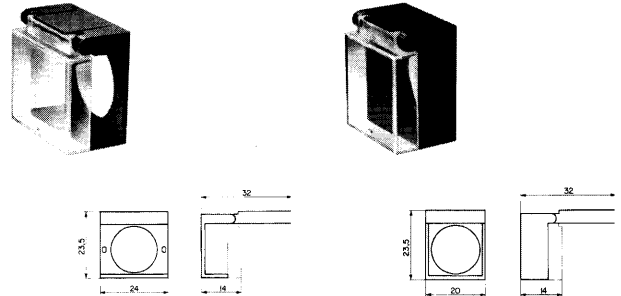

Order No.

0886.0004

0886.0003

Blanking plate black

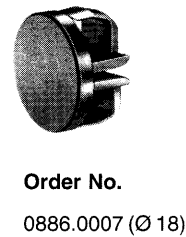

Order No.



0886.0007 (Ø 18)

Availability: ex warehouse or prompt delivery

Accessories S10























Lenses / plate inserts



			
Colours	18 x 24	18 x 18	ø 18
clear glass	0854.0581	0854.0601	0854.0621
clear red	0854.0582	0854.0602	0854.0622
clear green	0854.0583	0854.0603	0854.0623
clear yellow	0854.0584	0854.0604	0854.0624
clear blue	0854.0585	0854.0605	0854.0625
pearl	0854.0591	0854.0611	0854.0631
diffused red	0854.0592	0854.0612	0854.0632
diffused green	0854.0593	0854.0613	0854.0633
diffused yellow	0854.0594	0854.0614	0854.0634
diffused blue •	0854.0595	0854.0615	0854.0635
black •	0854.0596	0854.0616	0854.0636

• not recommended for illuminated switches

Order No. legend plate inserts

	18 x 24	18 x 18	ø 18		18 x 24	18 x 18	ø 18
	0854.0871	0854.0872	0854.0873		0854.1414	0854.1614	0854.1814
	0854.1402	0854.1602	0854.1802		0854.1415	0854.1615	0854.1815
	0854.1403	0854.1603	0854.1803		0854.1416	0854.1616	0854.1816
	0854.1404	0854.1604	0854.1804		0854.1417	0854.1617	0854.1817
	0854.1405	0854.1605	0854.1805		0854.1418	0854.1618	0854.1818
	0854.1406	0854.1606	0854.1806		0854.1419	0854.1619	0854.1819
	0854.1407	0854.1607	0854.1807		0854.1420	0854.1620	0854.1820
	0854.1408	0854.1608	0854.1808		0854.1421	0854.1621	0854.1821
	0854.1409	0854.1609	0854.1809		0854.1422	0854.1622	0854.1822
	0854.1410	0854.1610	0854.1810		0854.1423	0854.1623	0854.1823
	0854.1411	0854.1611	0854.1811				
	0854.1412	0854.1612	0854.1812				
	0854.1413	0854.1613	0854.1813				

The white / translucent legend plate with black inscriptions use only with clear glass lenses.

Other legends on plate inserts available on request. Availability: ex warehouse or prompt delivery

Availability: ex warehouse or prompt delivery

Key switches EMS

for panel mounting
precision-machined barrel **KABA** micro-E
1 N.O.

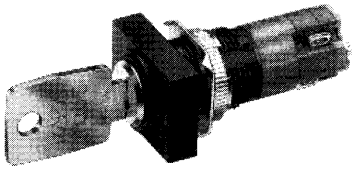

Standards and approvals
SEV 1005, VDE 0630, CSA C 22.2/14,
UL 508, CEE 24

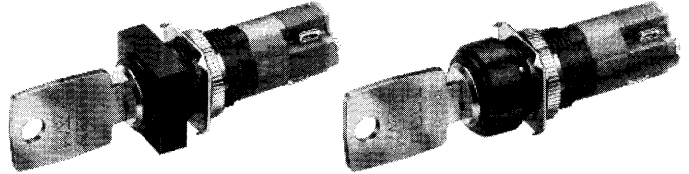

Approvals:

SEV-Approval	No. 89.551901.01
VDE-Certificate	No. 04
UL-Recognition	No. E 118787
CSA-Certification	No. LR 73360

mounting hole
18 x 24 mm

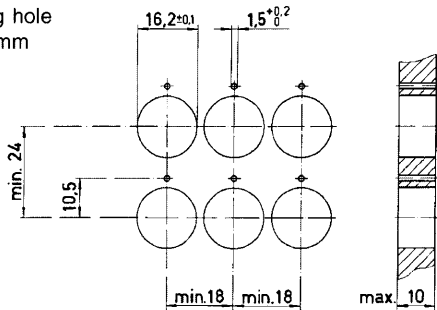

mounting hole
18 x 18 mm
ø 18 mm

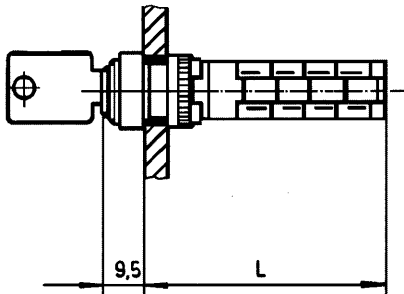
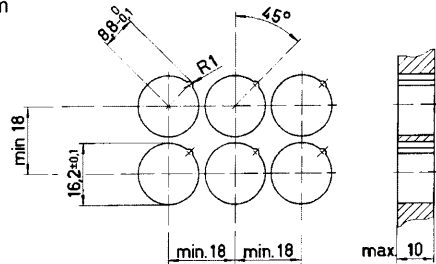

L = see
page 9

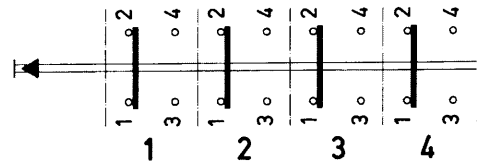

Technical data

Switching mechanism

snap contacts with minimum bounce and optimum self-cleaning characteristics

Contact blocks

normally 1 N.C. and 1 N.O.

Contact material

hard silver, 5 µm hard gold-plated

Initial contact resistance (new)

typically 5 mΩ

Breaking capacity

5 A, 250 V AC (cos φ 0,7)

Mechanical lifetime

ca. 2 x 10⁶ operations

Electrical lifetime

ca. 7 x 10⁴ operations (cos φ 0,7)

Ambient temperature

-30 °C up to +80 °C

Acceleration

10 g in all three dimensions

Vibration resistance

IEC 68-2-6 test Fc details on request

Degree of protection

IP 40 IEC 529

Terminals

stranded cable 2 x 1 mm²
wire 4 x 0.75 mm²

Materials

temperature resistant thermoplastic, contact housing
moulded in electrical high-grade thermosetting plastic
current-carrying parts Cu-alloy

Availability: ex warehouse or prompt delivery

Key switches S10

Standards and approvals
SEV 1005, VDE 0630, CSA C 22.2/14,
UL 508, CEE 24



Order No.

Order No.	Flange □ (18 x 24 mm)	Key removable positions			Number of contact elements (1 N.C. + 1 N.O.)				Length L from flange [mm]			
		1 Off (Impulse)	1 Off	1 + 2 On, Off	1	2	3	4	35,5	44,0	52,5	61,0
0041.2701	●	●			●				●			
0041.2702	●	●				●				●		
0041.2711	●		●		●				●			
0041.2712	●		●			●				●		
0041.2721	●			●	●				●			
0041.2722	●			●		●				●		
Order No.	Flange □ (18 x 18 mm)	Key removable positions			Number of contact elements (1 N.C. + 1 N.O.)				Length L from flange [mm]			
		1 Off (Impulse)	1 Off	1 + 2 On, Off	1	2	3	4	35,5	44,0	52,5	61,0
0041.2731	●	●			●				●			
0041.2732	●	●				●				●		
0041.2741	●		●		●				●			
0041.2742	●		●			●				●		
0041.2751	●			●	●				●			
0041.2752	●			●		●				●		
Order No.	Flange ○ (ø 18 mm)	Key removable positions			Number of contact elements (1 N.C. + 1 N.O.)				Length L from flange [mm]			
		1 Off (Impulse)	1 Off	1 + 2 On, Off	1	2	3	4	35,5	44,0	52,5	61,0
0041.2761	●	●			●				●			
0041.2762	●	●				●				●		
0041.2771	●		●		●				●			
0041.2772	●		●			●				●		
0041.2781	●			●	●				●			
0041.2782	●			●		●				●		

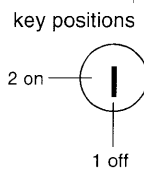

- inclusive:
- 1 key
 - 1 anti-rotation washer
 - 1 thermoplastic nut
(metal nut if required)

Execution with 3 and 4 contact elements available
(not on stock)

Mounting key (metal) Order No. 0853.0654

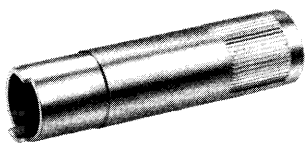

for metal nut only

Spare key Order No. 0886.0020

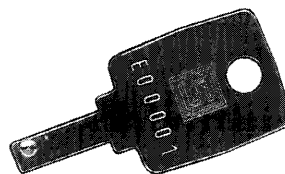

Availability: ex warehouse or prompt delivery



NKCR2.E172884

Auxiliary Devices - Component

[Page Bottom](#)[Print-friendly version](#)[Questions?](#)[Previous Page](#)

Auxiliary Devices - Component

[See General Information for Auxiliary Devices - Component](#)

SCHWEITZER SCHALTSYSTEME AG

E172884

TAGERHARDSTRASSE 90

5430 WETTINGEN, SWITZERLAND

Pilot lights.Series 10 followed by 0035, followed by 55, followed by 01, 11, or 21 .

Series 10 followed by 0041 , followed by .23 followed by 01 thru 04 or followed by 11 thru 14 or followed by 21 thru 24 or followed by 51 thru 54 or followed by 61 thru 64 or followed by 71 thru 74.

Marking: Company name and type designation.

[Last Updated](#) on 2004-01-27

[Page Top](#)[Notice of Disclaimer](#)[Questions?](#)[Previous Page](#)[UL Listed and Classified Products](#)[UL Recognized Components](#)[Products Certified for Canada](#)

This page and all contents are Copyright © 2005 by Underwriters Laboratories Inc.®

The appearance of a company's name or product in this database does not in itself assure that products so identified have been manufactured under UL's Follow-Up Service. Only those products bearing the UL Mark should be considered to be Listed and covered under UL's Follow-Up Service. Always look for the Mark on the product.

UL permits the reproduction of the material contained in the Online Certification Directory subject to the following conditions: 1. The Guide Information, Designs and/or Listings (files) must be presented in their entirety and in a non-misleading manner, without any manipulation of the data (or drawings). 2. The statement "Reprinted from the Online Certifications Directory with permission from Underwriters Laboratories Inc." must appear adjacent to the extracted material. In addition, the reprinted material must include a copyright notice in the following format: "Copyright © 2005 Underwriters Laboratories Inc.®"