

DIGITAL PRESSURE SENSOR

New **DP-100** SERIES



A New Global Standard

Dual display for the digital pressure sensors of the future



Industry first.* Dual 3-color display makes operation easier!

The dual display means that the 'current value' and the 'threshold value' can be displayed at the same time to improve ease of operation and visual checking. Introducing a new standard in digital pressure sensor technology.

* As of November 2005 and based on research conducted by SUNX for 30 mm 1.181 in square sized digital pressure sensors.

A new global standard 'Current value' and 'threshold value' can be checked at the same time!

Dual display allows direct setting of threshold value

Equipped with a 30 mm 1.181 in square compact-sized dual display. Because the current value and the threshold value can be checked at the same time, the threshold value can be set and checked smoothly without having to switch screen modes. ON / OFF operations are still carried out while the threshold values are being set, so setting to the same sensitivity as dial control-type sensors is possible. And naturally a key lock function is also equipped.

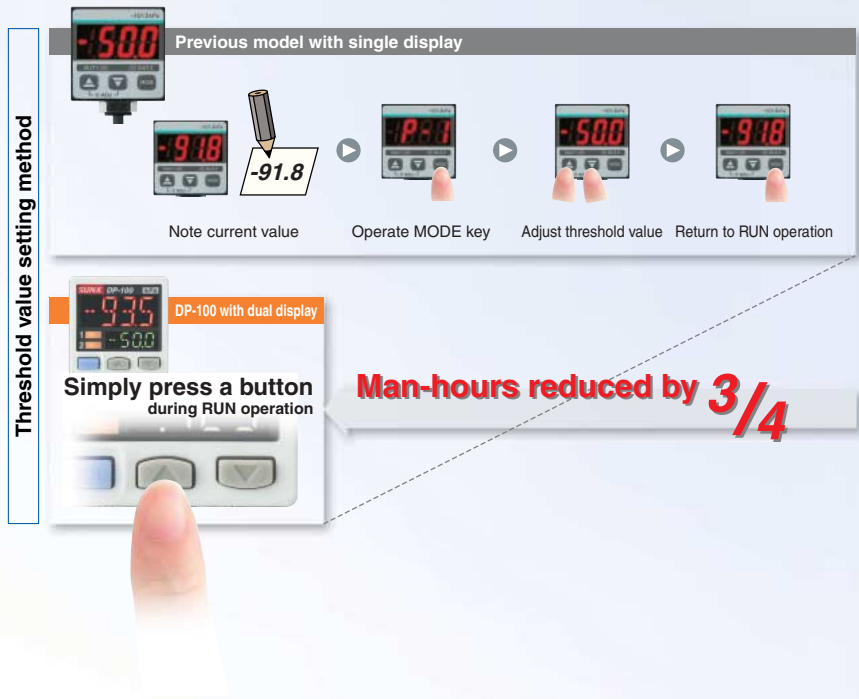

3-color display (Red, Green, Orange)

The main display changes color in line with changes in the status of output ON / OFF operation, and it also changes color while setting is in progress. The sensor status can therefore be understood easily, and operating errors can be reduced.

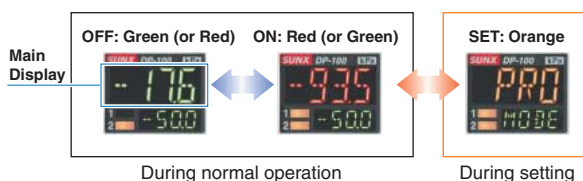

Readable digital display!

12 segments are used and an alphanumeric display has been adopted. This improves visual checking of letters and numbers.

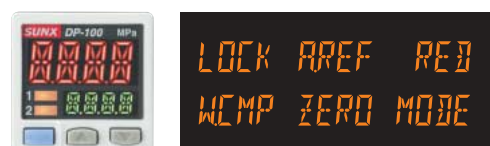

Dual Display + Direct setting



Direct setting means
**Works like a dial
control type sensor**

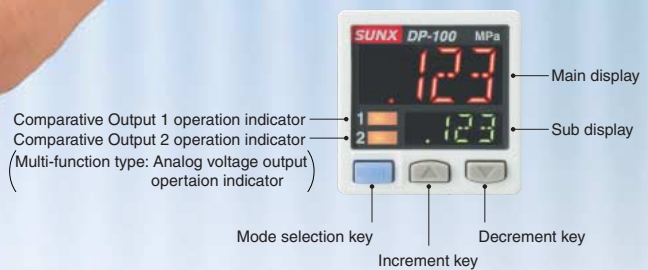

Copy function lets work be carried out accurately and quickly

Copy function reduces man-hours and human error

Sensors can be connected to a master sensor one by one, and a copy of the setting details for the master sensor can be transmitted as data to the other sensors. If making the same settings for multiple sensors, this prevents setting errors from occurring with the other sensors and also reduces the number of changes required to instruction manuals when equipment designs are changed.

Setting details can be copied.

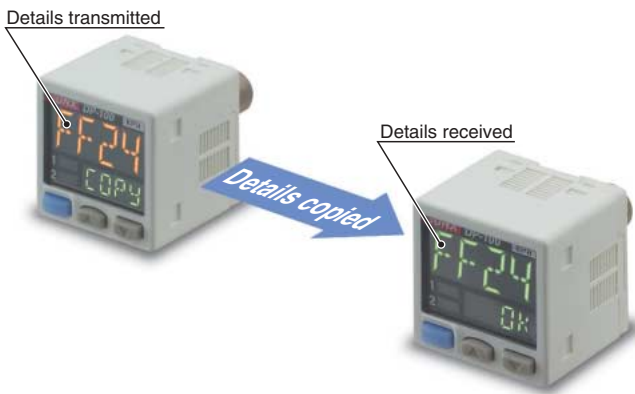

Copying via wiring

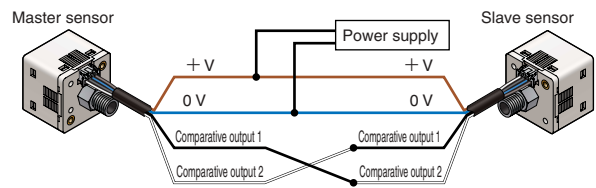

Advantage 1 Setting man-hours are reduced and sensor setting time is shortened.

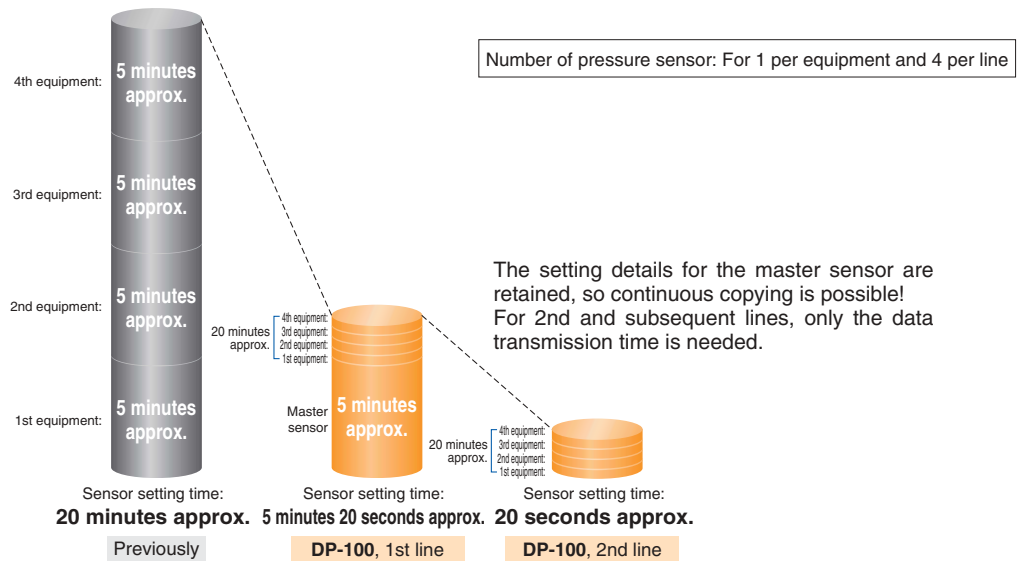

Advantage 2 Human operating error is reduced.

- Because all details are copied automatically, it prevents problems occurring as a result of human error.
- Instruction manuals can be updated easily when changes occur to equipment design!

Setting is smooth and easy

The sensor's setting operation mode has a 3-level configuration to suit the frequency of use.

The setting levels are clearly separated into 'RUN mode' for operation settings that are carried out daily, 'MENU SETTING mode' for basic settings, and 'PRO mode' for special and detailed setting. These make setting operations easy to understand and easy to carry out.

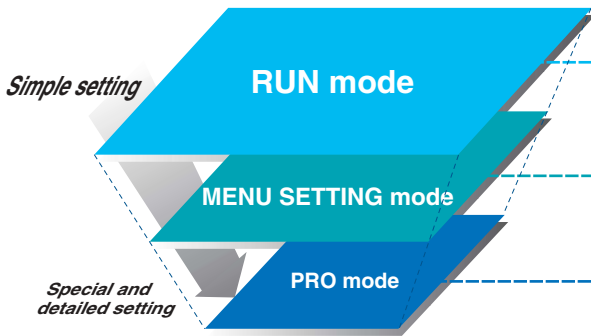

RUN mode



Settings such as threshold value adjustment and key lock operation can be carried out while the sensor is operating.

MENU SETTING mode



Basic settings such as output mode setting and NO / NC switching can be carried out.

PRO mode



High-level function settings such as hysteresis adjustment and the copy function can be carried out.

Display is orange while setting is in progress

The display appears in red and green during RUN operation, but it changes to orange while setting is in progress, so that the sensor status can be viewed at a glance.

RUN operation

RUN mode



Red or green when output is ON / OFF

While setting

MENU SETTING mode

PRO mode



Orange while setting is in progress

Default settings that can be used straight away

Easy-to-use default settings are provided for applications that are used frequently by pressure sensors. The default settings for low pressure types are ideal for suction checking applications, and those for high pressure types are ideal for checking reference pressure.

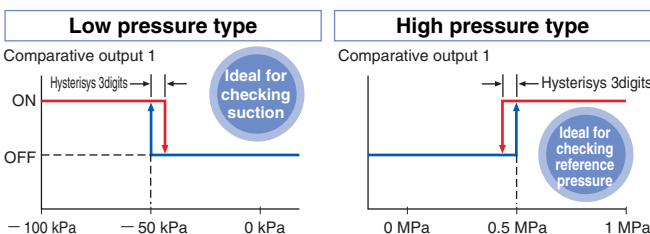

Buttons with good clicking touch

The buttons have a good clicking touch, allowing smooth setting.



The clicking feeling is transmitted even through gloves.

Reset function

If a problem ever occurs with the sensor settings, they can be returned to the default settings.

Full range of performance and functions in a compact body

All models in the line-up are compound pressure types

No sensor settings are required to switch between positive pressure and negative pressure, so that the number of registered part numbers can be decreased.

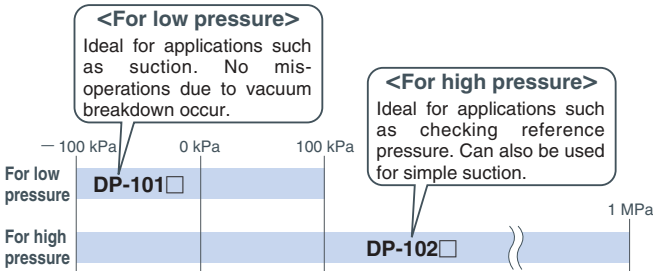

Realizes high performance **Low pressure type**

The low pressure type displays measurements in 0.1 kPa at a resolution of 1/2000 and has a response time of 2.5 ms (variable up to 5,000 ms), $\pm 0.5\%$ F.S. temperature characteristics and $\pm 0.1\%$ F.S. repeatability, giving it high performance.

- Resolution: 1/2,000
- Response time: 2.5 ms
- Temperature characteristics: $\pm 0.5\%$ F.S.
- Repeatability: $\pm 0.1\%$ F.S.



Displays measurements in 0.1 kPa

Equipped with independent dual output **Standard type**

Equipped with two independent comparative outputs, and separate sensing modes can be selected for each of them. One of the comparative outputs can even be used for alarm output. In addition, if an output is not being used, it can be disabled.

• Vacuum breakdown can also be checked during suction applications!

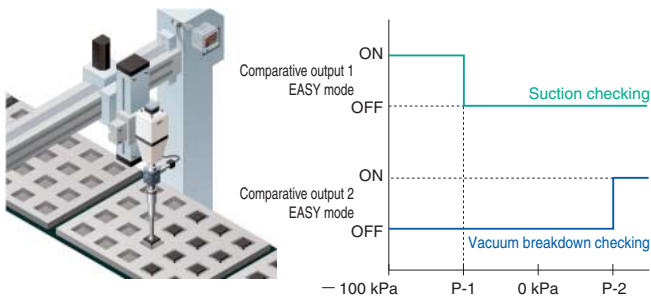

• Reference pressure alarm output is possible during reference pressure checking!

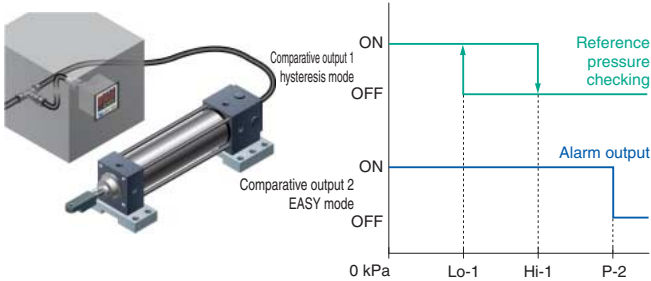

Three output modes are suitable for a wide range of applications

1 EASY mode

This mode is used for comparative output ON / OFF control.

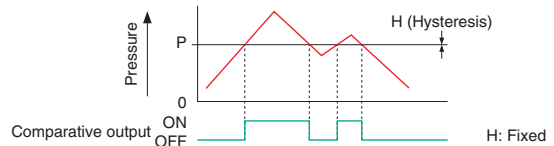

- Notes: 1) Hysteresis can be fixed to one of eight different levels.
- 2) 'P-1' appears in the sub display for comparative output 1, and 'P-2' appears for comparative output 2.

2 Hysteresis mode

This mode is used for setting comparative output hysteresis to the desired level and for carrying out ON / OFF control.

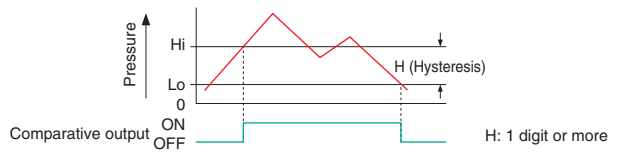

- Note: 'Hi-1' or 'Lo-1' appears in the sub display for comparative output 1, and 'Hi-2' or 'Lo-2' appears for comparative output 2.

3 Window comparator mode

This mode is used for setting comparative output ON and OFF at pressures within the setting range.

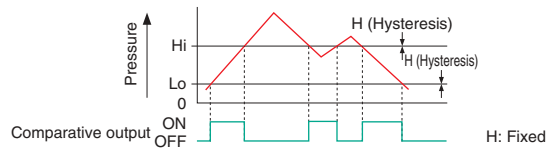

- Notes: 1) Hysteresis can be fixed to one of eight different levels.
- 2) 'Hi-1' or 'Lo-1' appears in the sub display for comparative output 1, and 'Hi-2' or 'Lo-2' appears for comparative output 2.

Switching is possible between analog voltage output and external input Multi-function type

Multi-function type is available that allows selection of analog voltage output or external input (auto-reference / remote zero-adjustment). This is suitable for multi-specification applications.

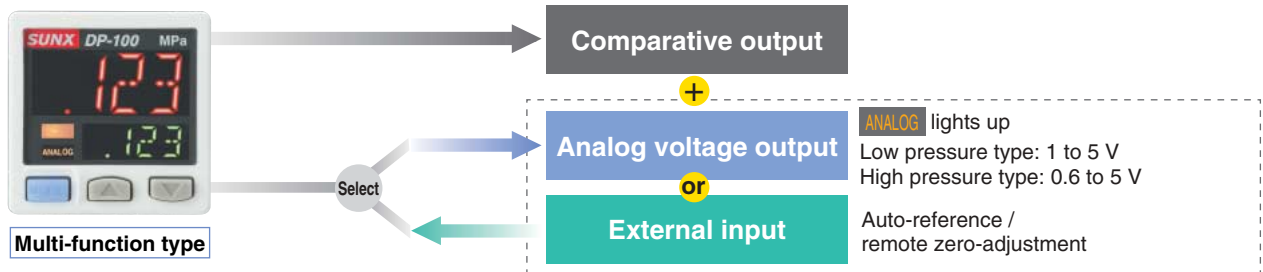

Equipped with auto-reference / remote zero-adjustment functions Multi-function type More precise pressure management is possible with a minimum of effort

If the reference pressure of the device changes, the auto-reference function partially shifts the comparative output judgment level by the amount that the reference pressure shifts, and the remote zero-adjustment function can reset the display value to zero via external input. These functions are ideal for places where the reference pressure fluctuates wildly, or where fine settings are desired.

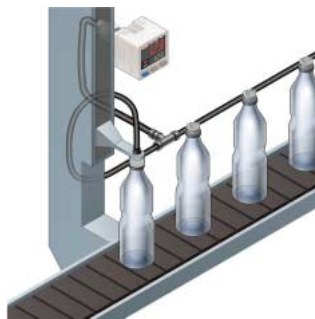

Without auto-reference and remote zero-adjustment functions

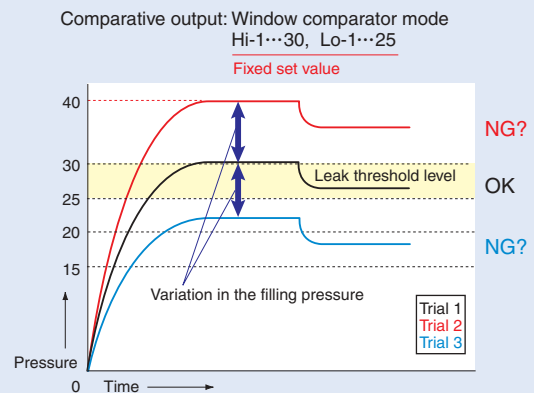

Because the threshold level is fixed for conventional pressure sensors, changes in the reference pressure result in wrong decisions.

With auto-reference function applied

Comparative output: Window comparator mode
Hi-1...0, Lo-1... -5
Sets the absolute threshold level

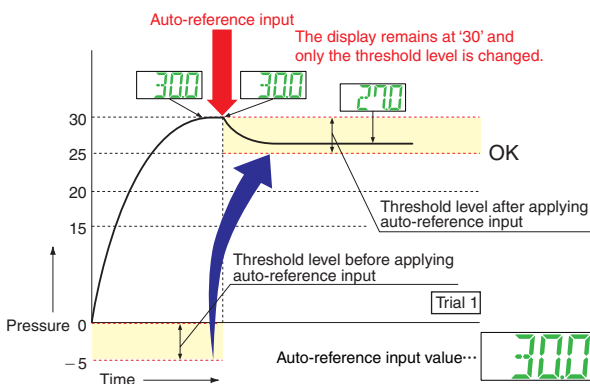

When auto-reference input is applied, the reference pressure '30' is added to the threshold level. If the reference pressure changes to '20' or '40', the auto-reference input compensates for this every time by changing the threshold level, so any variation in the filling pressure can be ignored.

With remote zero-adjustment function applied

Comparative output: Window comparator mode
Hi-1...0, Lo-1... -5
Sets the absolute threshold level

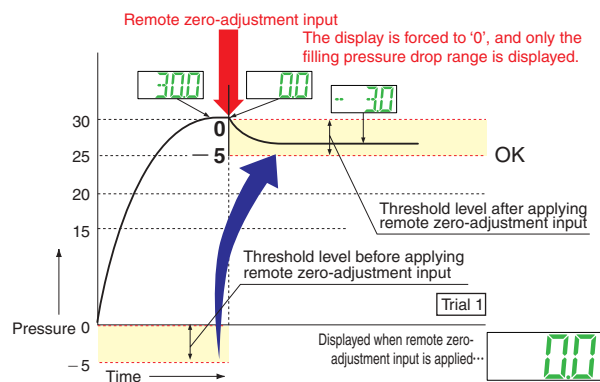

When remote zero-adjustment input is applied, the reference pressure is forced to '0'. If the reference pressure changes to '20' or '40', the remote zero-adjustment input adjusts the reference pressure to '0' every time the reference pressure changes, so any variation in the filling pressure can be ignored.

Other useful functions

Sub display can be customized

The sub display can be set to indicate any other desired values or letters apart from the threshold value. This eliminates the need for tasks such as affixing a label to the device to indicate the normal pressure value.



Indicates desired values and letters

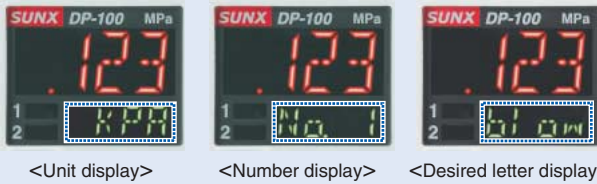

Peak hold and Bottom hold functions

The peak values and bottom values for fluctuating pressures can be displayed using the dual display.

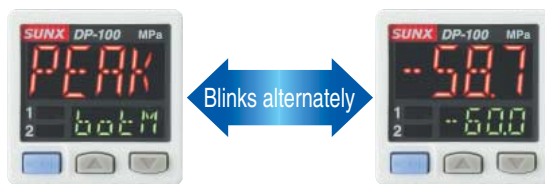

Response time can be changed

The response time can be changed in 10 levels from 2.5 ms to 5,000 ms. This prevents chattering and incorrect operation due to sudden changes in pressure.

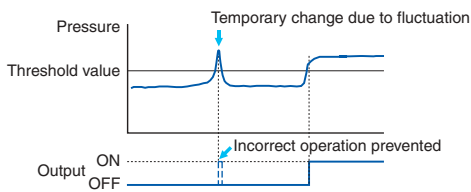

Setting details can be understood at a glance

The DP-100 setting details appear in the digital display. Because the settings are in numeric form that can be easily understood, it is useful for times such as when receiving technical support by telephone.

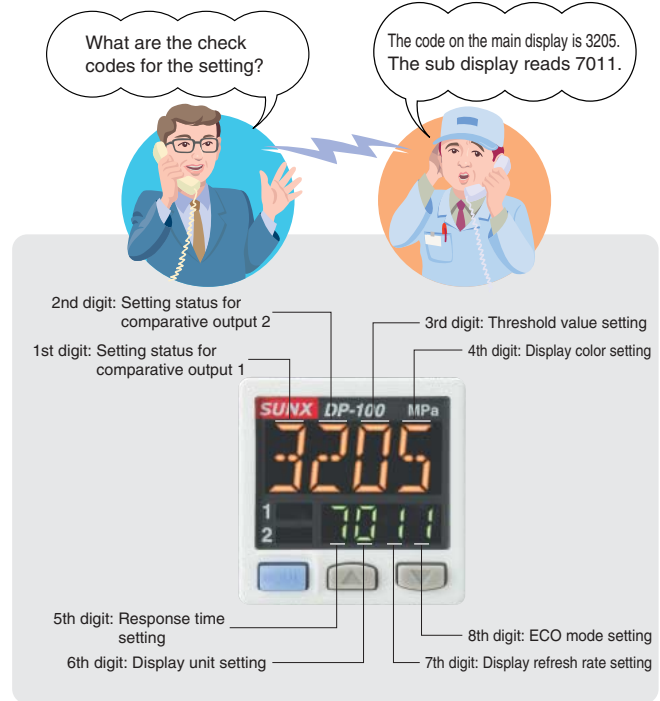

Energy-saving design! Equipped with an ECO mode

This mode lowers the display luminance to cut power consumption by approximately 30%. The displays can also be turned off completely to achieve a power saving of approximately 40%.

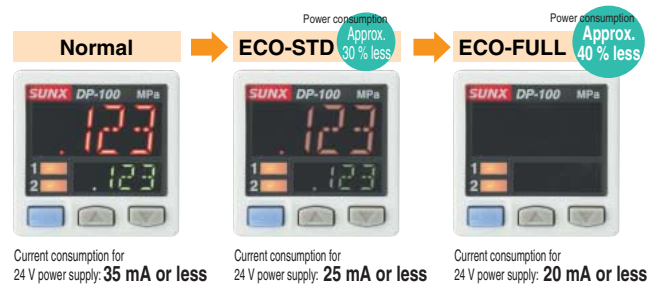

Display refresh rate can be varied

The display refresh rate for the digital displays can be changed to one of three settings: 250 ms, 500 ms or 1,000 ms. Flickering of the display can be reduced by making the display refresh rate longer.

Installation is also easy!

Tight installation to panels is possible

An exclusive mounting bracket that is suitable for 1 to 6 mm 0.039 to 0.236 in panel thickness is available.

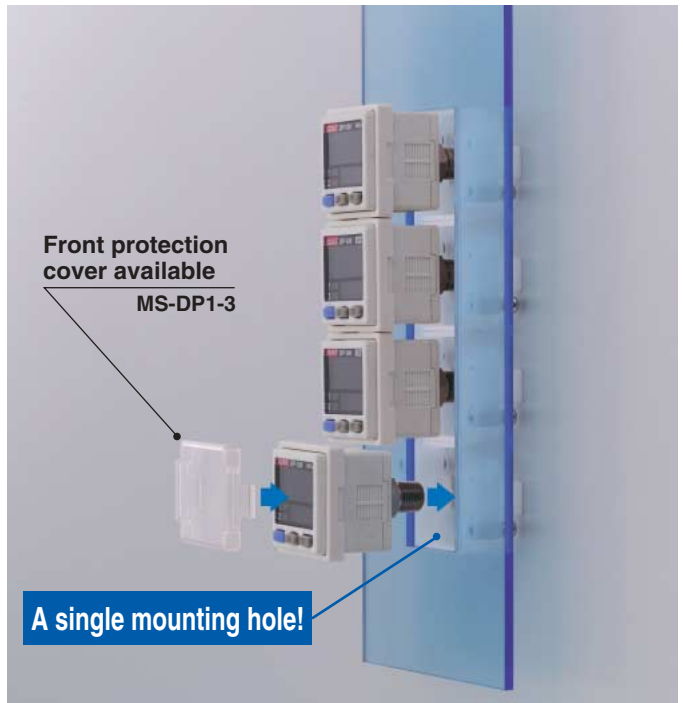

- An exclusive mounting bracket (MS-DP1-1) that supports tight installation is available

Space savings can also be obtained if an L-shaped mounting bracket is used.

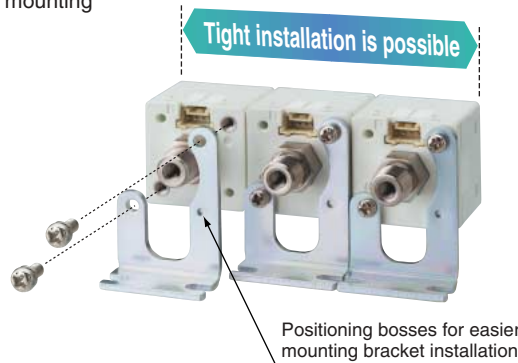

Cable can be connected with one-touch connection

The accessory connector attached cable (2 m 6.562 ft) can be connected easily with one-touch connection.

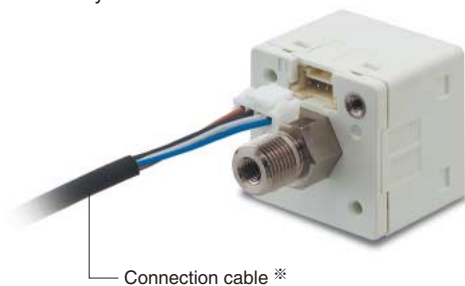

※ Options: 1 m 3.281 ft / 3 m 9.843 ft / 5 m 16.404 ft types are also available.

- Types without connector attached cable are also available **DP-10□-J**

Commercially-available connectors can be used for cable connections. Only the required length of cable needs to be used, which contributes to a reduced amount of wastage for unneeded cable.

Environmentally friendly



ORDER GUIDE

Type		Appearance	Rated pressure range	Model No.	Pressure port	Comparative output
Asian	Standard	For low pressure	- 100.0 to + 100.0 kPa	DP-101	M5 female thread + R (PT) 1/8 male thread	NPN open-collector transistor
		For high pressure	- 0.100 to + 1.000 MPa	DP-102		
	Multi-function	For low pressure	- 100.0 to + 100.0 kPa	DP-101A		
		For high pressure	- 0.100 to + 1.000 MPa	DP-102A		
European	Standard	For low pressure	- 100.0 to + 100.0 kPa	DP-101-E-P	M5 female thread + G 1/8 male thread	PNP open-collector transistor
		For high pressure	- 0.100 to + 1.000 MPa	DP-102-E-P		
	Multi-function	For low pressure	- 100.0 to + 100.0 kPa	DP-101A-E-P		
		For high pressure	- 0.100 to + 1.000 MPa	DP-102A-E-P		
North American	Standard	For low pressure	- 100.0 to + 100.0 kPa	DP-101-N	M5 female thread + NPT 1/8 male thread	NPN open-collector transistor
				DP-101-N-P		PNP open-collector transistor
		For high pressure	- 0.100 to + 1.000 MPa	DP-102-N		NPN open-collector transistor
				DP-102-N-P		PNP open-collector transistor
	Multi-function	For low pressure	- 100.0 to + 100.0 kPa	DP-101A-N		NPN open-collector transistor
				DP-101A-N-P		PNP open-collector transistor
		For high pressure	- 0.100 to + 1.000 MPa	DP-102A-N		NPN open-collector transistor
				DP-102A-N-P		PNP open-collector transistor



※**CN-14A-C2**
(Connector attached)
cable 2 m 6.562 ft)
is attached.

Types without connector attached cable

Types without connector attached cable are available. When ordering this type, add '-J' at the end of the Model No.

Model No: **DP-101-J, DP-101-E-P-J, DP-101-N-J, DP-101-N-P-J**
DP-102-J, DP-102-E-P-J, DP-102-N-J, DP-102-N-P-J

Accessory

CN-14A-C2 (Connector attached cable 2 m 6.562 ft)



OPTIONS

Designation	Model No.	Description	
Connector attached cable	CN-14A-C1	1 m 3.281 ft	0.2 mm ² 4-core cabtyre cable with connector on one end Cable outer diameter: ϕ 3.7 mm ϕ 0.146 in
	CN-14A-C3	3 m 9.843 ft	
	CN-14A-C5	5 m 16.404 ft	
Connector	CN-14A On the market soon	Set of 10 housings and 40 contacts	
Sensor mounting bracket	MS-DP1-1	Allows sensors to be installed to face in the direction of the floor or ceiling. Multiple sensors can also be mounted closely.	
Panel mounting bracket	MS-DP1-2	Allows installation to panels with thickness of 1 to 6 mm 0.039 to 0.236 in.	
Front protection cover	MS-DP1-3	Protects the adjustment surfaces of sensors. (Can be attached when using the panel mounting bracket)	

Sensor mounting bracket

• MS-DP1-1

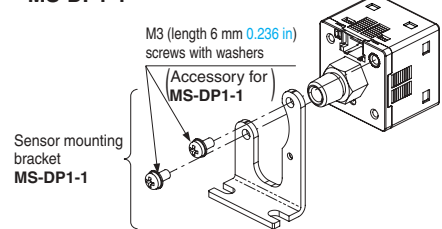

Panel mounting bracket, Front protection cover

• MS-DP1-2 • MS-DP1-3

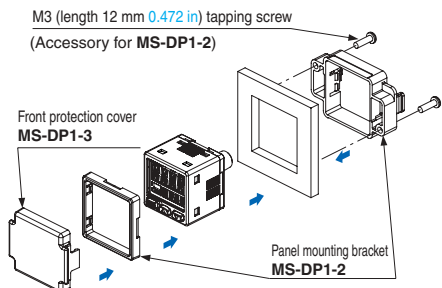

SPECIFICATIONS

Item	Model No.	Type	Standard		Multi-function	
			For low pressure	For high pressure	For low pressure	For high pressure
			DP-101	DP-102	DP-101A	DP-102A
	Asian	DP-101-E-P	DP-102-E-P	DP-101A-E-P	DP-102A-E-P	
	European	DP-101-N(-P)	DP-102-N(-P)	DP-101A-N(-P)	DP-102A-N(-P)	
	North American (Note 2)					
Type of pressure	Gauge pressure					
Rated pressure range	- 100.0 to + 100.0 kPa		- 0.100 to + 1.000 MPa		- 100.0 to + 100.0 kPa	
Set pressure range	$\left. \begin{array}{l} -100.0 \text{ to } +100.0 \text{ kPa} \\ -1.020 \text{ to } +1.020 \text{ kgf/cm}^2 \\ -1.000 \text{ to } +1.000 \text{ bar} \\ -14.50 \text{ to } +14.50 \text{ psi} \\ -750 \text{ to } +750 \text{ mmHg} \\ -29.5 \text{ to } 29.5 \text{ inHg} \end{array} \right\}$		$\left. \begin{array}{l} -0.100 \text{ to } +1.000 \text{ MPa} \\ -100 \text{ to } +1,000 \text{ kPa} \\ -1.02 \text{ to } +10.20 \text{ kgf/cm}^2 \\ -1.00 \text{ to } +10.00 \text{ bar} \\ -14.6 \text{ to } +145.0 \text{ psi} \end{array} \right\}$		$\left. \begin{array}{l} -100.0 \text{ to } +100.0 \text{ kPa} \\ -1.020 \text{ to } +1.020 \text{ kgf/cm}^2 \\ -1.000 \text{ to } +1.000 \text{ bar} \\ -14.50 \text{ to } +14.50 \text{ psi} \\ -750 \text{ to } +750 \text{ mmHg} \\ -29.5 \text{ to } 29.5 \text{ inHg} \end{array} \right\}$	
Pressure withstandability	500 kPa		1.5 MPa		500 kPa	
Applicable fluid	Non-corrosive gas					
Selectable unit	For low pressure: kPa, kgf/cm ² , bar, psi, mmHg, inHg, For high pressure: MPa, kPa, kgf/cm ² , bar, psi					
Supply voltage	12 to 24 V DC \pm 10 % Ripple P-P 10 % or less					
Power consumption	Normal operation: 840 mW or less (Current consumption 35 mA or less at 24 V supply voltage) ECO mode: 600 mW or less at STD (Current consumption 25 mA or less at 24 V supply voltage) 480 mW or less at FULL (Current consumption 20 mA or less at 24 V supply voltage)					
Comparative output	<Asian, North American (NPN output)> NPN open-collector transistor		<European, North American (PNP output)> PNP open-collector transistor			
	<ul style="list-style-type: none"> Maximum sink current: 100 mA Applied voltage: 30 V DC or less (between comparative output and 0 V) Residual voltage: 2 V or less (at 100 mA sink current) 		<ul style="list-style-type: none"> Maximum source current: 100 mA Applied voltage: 30 V DC or less (between comparative output and + V) Residual voltage: 2 V or less (at 100 mA source current) 			
	Output operation	NO / NC (selectable by key operation)				
	Output modes	EASY mode / Hysteresis mode / Window comparator mode				
	Hysteresis	Minimum 1 digit (variable) (however, 2 digits when using psi unit)				
	Repeatability	± 0.1 % F.S. (within ± 2 digits)	± 0.2 % F.S. (within ± 2 digits)	± 0.1 % F.S. (within ± 2 digits)	± 0.2 % F.S. (within ± 2 digits)	
	Response time	2.5 ms, 5 ms, 10 ms, 25 ms, 50 ms, 100 ms, 250 ms, 500 ms, 1,000 ms, 5,000 ms, selectable by key operation				
Short-circuit protection	Incorporated					
External input Auto-reference function / Remote zero-adjustment function	_____		<Asian, North American (NPN output)> ON voltage: 0.4 V DC or less OFF voltage: 5 to 30 V DC, or open Input impedance: 10 k Ω approx. Input time: 1 ms or more		<European, North American (PNP output)> ON voltage: 5 V to + V DC OFF voltage: 0.6 V DC or less, or open Input impedance: 10 k Ω approx. Input time: 1 ms or more	
	_____		Output voltage: 1 to 5 V DC Zero point: within 3 V \pm 5 % F.S. Span: within 4 V \pm 5 % F.S. Linearity: within ± 1 % F.S. Output impedance: 1 k Ω approx.		Output voltage: 0.6 to 5 V Zero point: within 1 V \pm 5 % F.S. Span: within 4.4 V \pm 5 % F.S. Linearity: within ± 1 % F.S. Output impedance: 1 k Ω approx.	
Analog voltage output	_____		Output voltage: 1 to 5 V DC Zero point: within 3 V \pm 5 % F.S. Span: within 4 V \pm 5 % F.S. Linearity: within ± 1 % F.S. Output impedance: 1 k Ω approx.		Output voltage: 0.6 to 5 V Zero point: within 1 V \pm 5 % F.S. Span: within 4.4 V \pm 5 % F.S. Linearity: within ± 1 % F.S. Output impedance: 1 k Ω approx.	
Display	4 digits + 4 digits 3-color LCD display (Display refresh rate: 250 ms, 500 ms, 1,000 ms, selectable by key operation)					
Displayable pressure range	$\left. \begin{array}{l} -100.0 \text{ to } +100.0 \text{ kPa} \\ -1.020 \text{ to } +1.020 \text{ kgf/cm}^2 \\ -1.000 \text{ to } +1.000 \text{ bar} \\ -14.50 \text{ to } +14.50 \text{ psi} \\ -750 \text{ to } +750 \text{ mmHg} \\ -29.5 \text{ to } 29.5 \text{ inHg} \end{array} \right\}$		$\left. \begin{array}{l} -0.100 \text{ to } +1.000 \text{ MPa} \\ -100 \text{ to } +1,000 \text{ kPa} \\ -1.02 \text{ to } +10.20 \text{ kgf/cm}^2 \\ -1.00 \text{ to } +10.00 \text{ bar} \\ -14.6 \text{ to } +145.0 \text{ psi} \end{array} \right\}$		$\left. \begin{array}{l} -100.0 \text{ to } +100.0 \text{ kPa} \\ -1.020 \text{ to } +1.020 \text{ kgf/cm}^2 \\ -1.000 \text{ to } +1.000 \text{ bar} \\ -14.50 \text{ to } +14.50 \text{ psi} \\ -750 \text{ to } +750 \text{ mmHg} \\ -29.5 \text{ to } 29.5 \text{ inHg} \end{array} \right\}$	
	_____		_____		_____	
Indicator	Orange LED (Comparative output 1 operation indicator, comparative output 2 operation indicator: Lights up when each comparative output is ON)		Orange LED (Comparative output 1 operation indicator: Lights up when comparative output is ON, Analog voltage output operation indicator: Lights up when setting)			
Environmental resistance	Pollution degree	IP40 (IEC)				
	Ambient temperature	- 10 to + 50 °C + 14 to + 122 °F, Storage: - 10 to + 60 °C + 14 to + 140 °F				
	Ambient humidity	35 to 85 % RH (No dew condensation or icing allowed), Storage: 35 to 85 % RH				
	Voltage withstandability	1,000 V AC for one min. between all supply terminals connected together and enclosure				
	Insulation resistance	50 M Ω , or more, with 500 V DC megger between all supply terminals connected together and enclosure				
	Vibration resistance	10 to 500 Hz frequency, 3 mm 0.118 in amplitude, in X, Y and Z directions for two hours each (when panel is mounted: 10 to 150 Hz frequency, 0.75 mm 0.030 in amplitude, in X, Y and Z directions for two hours each)				
	Shock resistance	100 m/s ² acceleration (10 G approx.) in X, Y and Z directions for three times each				
Temperature characteristics	Within ± 0.5 % F.S. (at + 20 °C + 68 °F)	Within ± 1 % F.S. (at + 20 °C + 68 °F)	Within ± 0.5 % F.S. (at + 20 °C + 68 °F)	Within ± 1 % F.S. (at + 20 °C + 68 °F)		
Pressure port	Asian: M5 female thread + R (PT) 1/8 male thread, European: M5 female thread + G 1/8 male thread, North American: M5 female thread + NPT 1/8 male thread					
Material	Enclosure: PBT (glass fiber reinforced), LCD display: Acrylic, Pressure port: Brass (nickel plated), Mounting threaded part: Brass (nickel plated), Switch part: Silicone rubber					
Connecting method	Connector					
Cable extension	Extension up to total 100 m 328.084 ft (less than 10 m 32.808 ft when conforming to CE marking) is possible with 0.3 mm ² , or more, cable					
Weight	Net weight: 40 g approx., Gross weight: 135 g approx.					
Accessories	CN-14A-C2 (Connector attached cable 2 m 6.562 ft): 1pc.					

Notes: 1) Where measurement conditions have not been specified precisely, the conditions used were ambient temperature + 20 °C + 68 °F.

2) Model Nos. of North American standard type having the suffix '-P' are PNP output type.



I/O CIRCUIT AND WIRING DIAGRAMS

NPN output type

I/O circuit diagram

Standard type

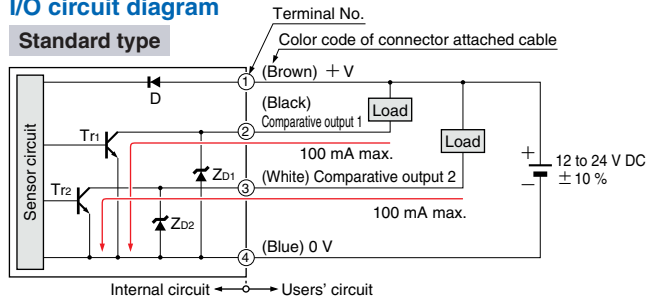

Symbols ... D : Reverse supply polarity protection diode
 Z_{D1}, Z_{D2} : Surge absorption zener diode
 T_{r1}, T_{r2} : NPN output transistor

Multi-function type

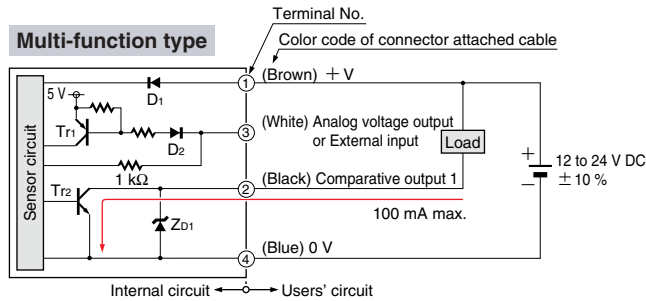

Symbols ... D₁, D₂ : Reverse supply polarity protection diode
 Z_{D1} : Surge absorption zener diode
 T_{r1} : PNP input transistor
 T_{r2} : NPN output transistor

Terminal arrangement diagram

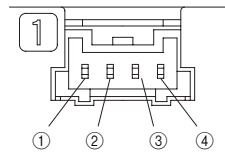

Terminal	Designation
①	+ V
②	Comparative output 1
③	Standard type: Comparative output 2 Multi-function type: Analog voltage output or External input
④	0 V

PNP output type

I/O circuit diagram

Standard type

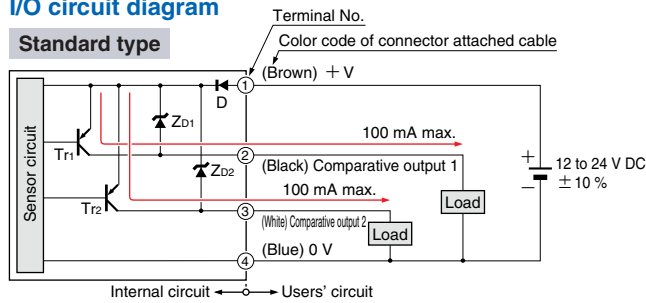

Symbols ... D : Reverse supply polarity protection diode
 Z_{D1}, Z_{D2} : Surge absorption zener diode
 T_{r1}, T_{r2} : PNP output transistor

Multi-function type

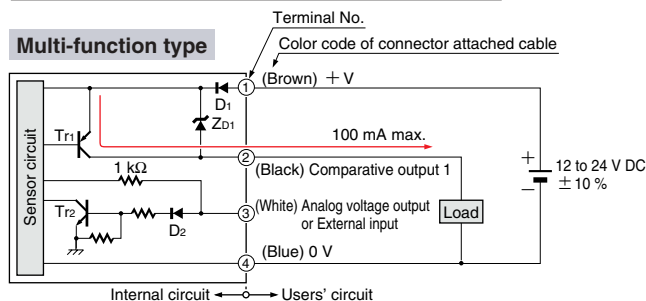

Symbols ... D₁, D₂ : Reverse supply polarity protection diode
 Z_{D1} : Surge absorption zener diode
 T_{r1} : PNP output transistor
 T_{r2} : NPN input transistor

Terminal arrangement diagram

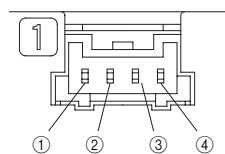

Terminal	Designation
①	+ V
②	Comparative output 1
③	Standard type: Comparative output 2 Multi-function type: Analog voltage output or External input
④	0 V

PRECAUTIONS FOR PROPER USE



- Never use this product as a sensing device for personnel protection.
- In case of using sensing devices for personnel protection, use products which meet regulations and standards, such as OSHA, ANSI or IEC etc., for personnel protection applicable in each region or country.
- The DP-100 series is designed for use with non-corrosive gas. It cannot be used with liquid or corrosive gas.

Wiring

- Make sure that the power supply is off while wiring.
- Verify that the supply voltage variation is within the rating.
- If power is supplied from a commercial switching regulator, ensure that the frame ground (F.G.) terminal of the power supply is connected to an actual ground.
- In case noise generating equipment (switching regulator, inverter motor, etc.) is used in the vicinity of this sensor, connect the frame ground (F.G.) terminal of the equipment to an actual ground.
- Do not run the wires together with high-voltage lines or power lines or put them in the same raceway. This can cause malfunction due to induction.
- Incorrect wiring will cause problems with operation.

Connection

- Do not apply stress directly to the connection cable leader or to the connector.

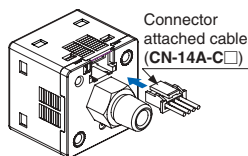

Conditions in use for CE conformity

- The DP-100 series is a CE conformity product complying with EMC Directive. The harmonized standard with regard to immunity that applies to this product is EN 61000-6-2 and the following condition must be met to conform to that standard.

Condition

- The sensor should be connected less than 10 m **32.808 ft** from the power supply.

Mounting

- The MS-DP1-1 sensor mounting bracket is available separately, and it should be used for mounting. When tightening the sensor to the sensor mounting bracket, use a tightening torque of 0.5 N·m or less.

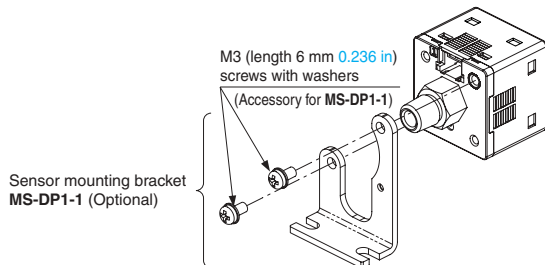

- The MS-DP1-2 panel mounting bracket (optional) and the MS-DP1-3 front protection cover (optional) are also available.

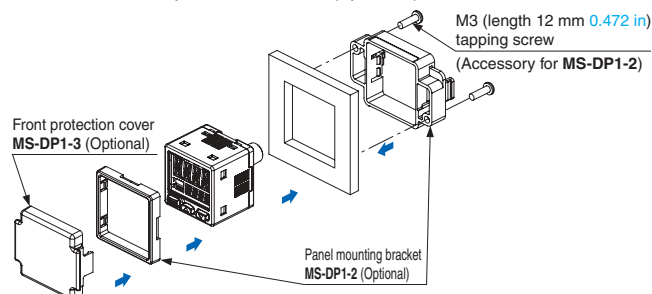

Piping

- If connecting a commercially-available coupling to the pressure port, attach a 12 mm **0.472 in** spanner (14 mm **0.551 in** spanner for DP-100-E type) to the hexagonal section of the pressure port to secure it, and tighten at a torque of 9.8 N·m or less. If it is tightened using excessive torque, it may damage the coupling or the pressure port. In addition, wrap sealing tape around the coupling when connecting it to prevent leaks.

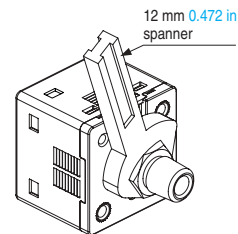

Others

- Use within the rated pressure range.
- Do not apply pressure exceeding the pressure withstandability value. The diaphragm will get damaged and correct operation shall not be maintained.
- Do not use during the initial transient time (0.5 sec. approx.) after the power supply is switched on.
- Avoid dust, dirt, and steam.
- Take care that the sensor does not come in direct contact with water, oil, grease, or organic solvents, such as, thinner, etc.
- Do not insert wires, etc., into the pressure port. The diaphragm will get damaged and correct operation shall not be maintained.
- Do not operate the keys with pointed or sharp objects.

RUN mode

- This is the normal operating mode.

Setting item	Description
Threshold value setting	The threshold values for ON / OFF operation can be changed directly by pressing the increment key (UP) and the decrement key (DOWN).
Zero-adjustment function	This forces the pressure value display to be reset to zero when the pressure port is open on the atmospheric pressure side.
Key lock function	Stops key operations from being accepted.
Peak hold / bottom hold function	Displays the peak value and bottom value for fluctuating pressure. The peak value appears in the main display, and the bottom value appears in the sub display.

MENU SETTING mode

- If the mode selection key is pressed and held for 2 seconds in RUN mode, the mode will switch to MENU SETTING mode.
- If the mode selection key is pressed while a setting is being made, the mode will switch to RUN mode. In this case, the settings that have been changed will be entered.

Setting item	Description
Comparative output 1 output mode setting	Sets the output mode for comparative output 1.
Comparative output 2 output mode setting (standard type only)	Sets the output mode for comparative output 2.
Analog voltage output / external input switching (multi-function type only)	Allows switching between analog voltage output and auto-reference input / remote zero-adjustment input.
NO / NC switching	Sets normally open (NO) or normally closed (NC).
Response time setting	Sets the response time. The response time can be selected from 2.5 ms, 5 ms, 10 ms, 25 ms, 50 ms, 100 ms, 250 ms, 500 ms, 1,000 ms and 5,000 ms.
Display color switching for main display	Allows the color for the main display to be changed. The colors can be set to 'red / green' or 'green / red' to correspond to ON / OFF output, or it can be fixed at 'red' or 'green' all the time.
Unit switching	Pressure unit can be changed.

PRECAUTIONS FOR PROPER USE

PRO mode

- If the mode selection key is pressed and held for 5 seconds in RUN mode, the mode will switch to PRO mode.
- If the mode selection key is pressed while a setting is being made, the mode will switch to RUN mode. In this case, the settings that have been changed will be entered.

Setting item	Description
Sub display switching	Changes the information in the sub display during RUN mode operation to the desired alphanumeric display.
Display refresh rate switching	Changes the display refresh rate for the pressure value displayed in the main display.
Hysteresis fix value switching	Sets the response time for EASY mode and window comparator mode. (8 steps)
Linked display color switching (standard type only)	Allows the display color for the main display to be switched in line with the output operation for comparative output 1 or comparative output 2.
ECO mode setting	Allows power consumption to be reduced by dimming the display or turning it off.
Setting check code	Allows the setting details to be checked via codes.
Setting copy mode	Allows the setting details for the master sensor to be copied to slave sensors.
Reset setting	Resets the settings to the factory settings.

Table of codes

Code	1st digit		2nd digit		Multi-function type	3rd digit	4th digit	
	Comparative output 1 output mode	NO / NC switching	Comparative output 2 output mode	NO / NC switching			Standard type	Standard type only
0	EASY	NO	OFF	OFF	Analog voltage output	P-1, Lo-1	Red when ON	Comparative output 1
1		NC	EASY	NO	Auto-reference	Hi-1		Comparative output 2
2	Hysteresis	NO		Hysteresis	NC	Remote zero-adjustment	P-2, Lo-2	Green when ON
3		NC	NO		—	Hi-2	Comparative output 2	
4	Window comparator	NO	Window comparator	NC	—	ADJ.	Always red	Comparative output 1
5		NC		NO	—	—		Comparative output 2
6	—	—	NC	—	—	—	Always green	Comparative output 1
7	—	—	—	—	—	—		Comparative output 2



Code	5th digit	6th digit	7th digit	8th digit
	Response time	Unit switching	Display refresh rate	ECO mode
0	2.5 ms	MPa	250 ms	OFF
1	5 ms	kPa	500 ms	STD
2	10 ms	kg/cm ²	1,000 ms	FULL
3	25 ms	bar	—	—
4	50 ms	psi	—	—
5	100 ms	mmHg	—	—
6	250 ms	inchHg	—	—
7	500 ms	—	—	—
8	1,000 ms	—	—	—
9	5,000 ms	—	—	—

DIMENSIONS (Unit: mm in)

The CAD data in the dimensions can be downloaded from the SUNX website: <http://www.sunx.co.jp/>

DP-100 Sensor

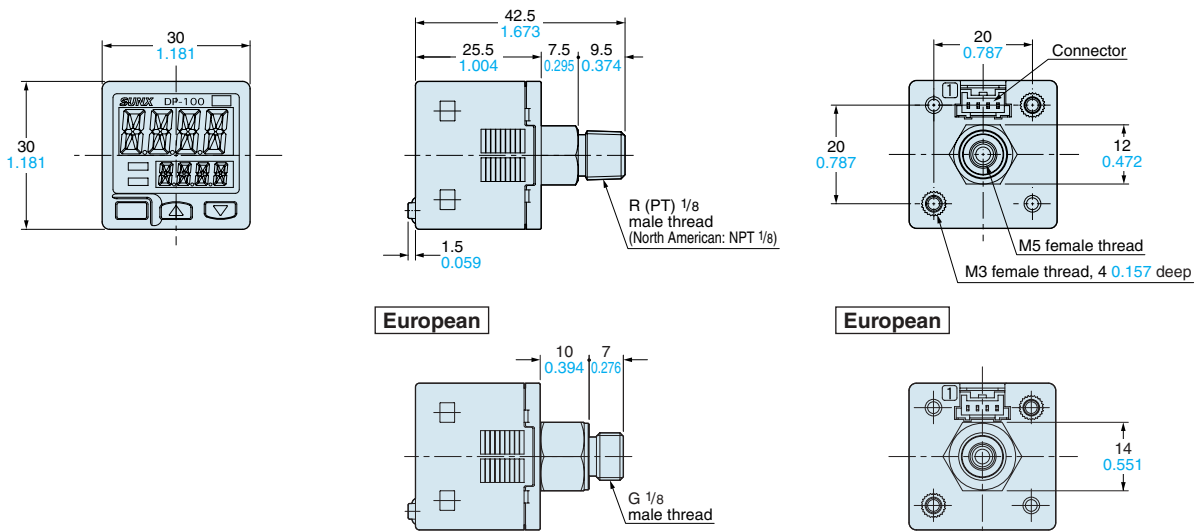

DIMENSIONS (Unit: mm in)

The CAD data in the dimensions can be downloaded from the SUNX website: <http://www.sunx.co.jp/>

MS-DP1-1 Sensor mounting bracket (Optional)

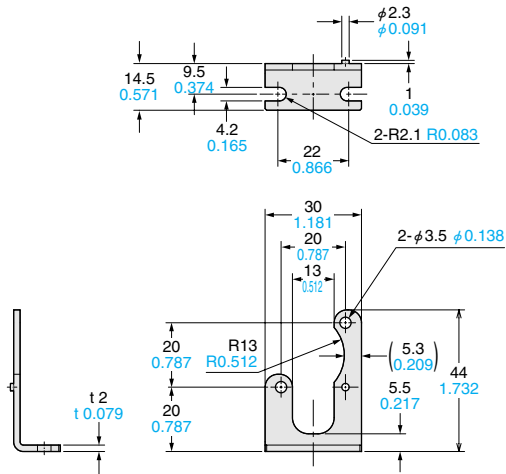

Assembly dimensions

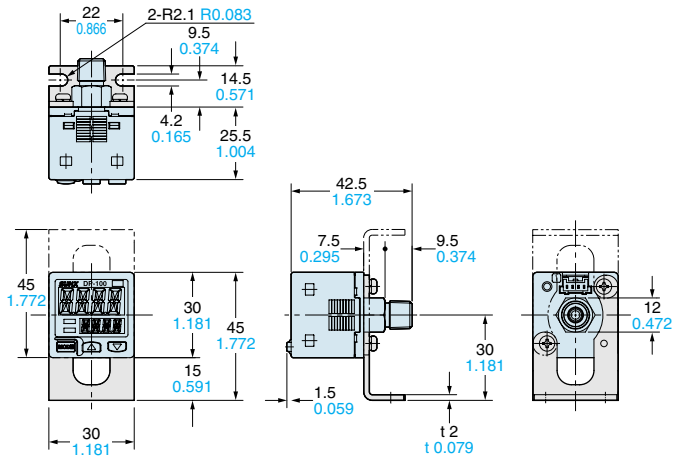

MS-DP1-2 Panel mounting bracket (Optional), **MS-DP1-3** Front protection cover (Optional)

Assembly dimensions

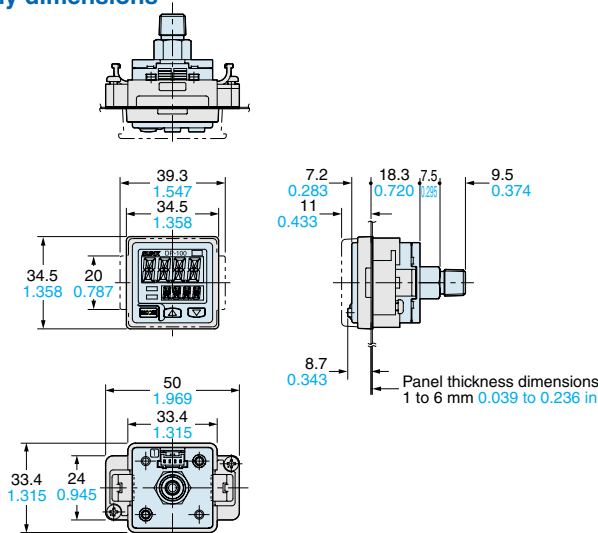

Panel cut-out dimensions

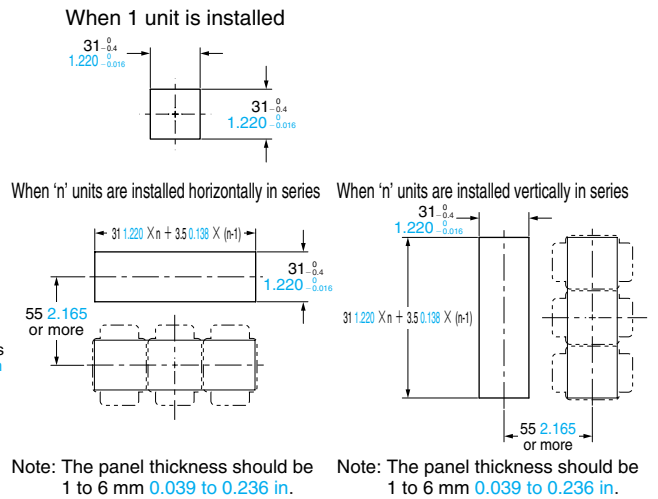

CN-14A-C Connector attached cable (Optional, **CN-14A-C2** is attached to the sensor)

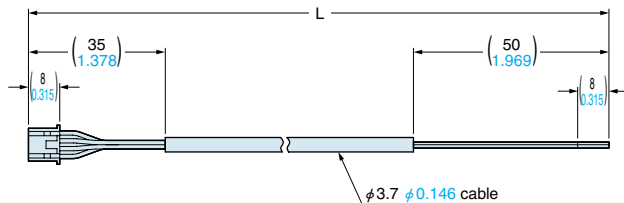

Model No.	Cable length (mm, in)
CN-14A-C1	1,000 39.370
CN-14A-C2	2,000 78.740
CN-14A-C3	3,000 118.110
CN-14A-C5	5,000 196.850

Compact Size • 2-color Digital Display

DP4 SERIES

New shape makes it most suitable for panel installation

Light-weight, compact design

A compact form specifically designed for mounting on an equipment panel. It only uses half the space of our conventional product and provides the lightest weight of just 30 g (cable excluded).

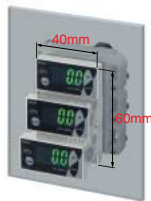

Bright, easy to view two-color digital display

The digital display is a large, easy-to-view, and two-color digital display. It is also functions as an output indicator as it changes from green to red color when the output turns ON, enabling you confirm the output status at a glance.

Supplied with a simple-to-mount panel mounting bracket

A panel mounting bracket (**MS-DP-1**) is enclosed to enable simple mounting of the sensor onto the panel surface, thus contributing to the total cost reduction.



Rated pressure range: **DP4-50/50P** 0 to -101.3 kPa
DP4-52/52P 0 to 1,000 MPa
DP4-57/57P -100.0 to 100.0 kPa
 Applicable fluid: Non-corrosive gas
 Supply voltage: 12 to 24 V DC $\pm 10\%$
 Output: **DP4-5□** NPN open-collector transistor
DP4-5□P PNP open-collector transistor
 Pressure port: M5 female thread
 Dimensions: W40 × H20 × D49 mm

Head-separated Type • 2-color Digital Display

DP5 SERIES Controller DPH SERIES Sensor head

1/1,000 second high-speed response!

Response time 1 ms

Mounting the detachable head close to the detecting section minimizes piping and enables response time of 1 ms, as well as greatly decreasing tact time delay. In addition, the ultra-small and light-weight design of the head means it can easily be mounted on moving sections.

Sensor head with operation indicator

The sensor head is also equipped with operation indicator. Output ON / OFF can be checked on the sensor head, so that it is suitable for checking operation at the suction head.



Independent use of sensor head possible

Light-weight, compact design

The controller inherits its lightweight, compact design from the popular **DP4** series of digital pressure sensors. Control panel setup is low cost and requires minimal space.

Convenient intermediate cable with connector

Intermediate cable with connectors for connecting the sensor head and the controller makes operation and maintenance easier.

Note: An intermediate cable is required to connect the controller and the sensor head. Please order the intermediate cable with connector separately.



Pressure sensor heads

Rated pressure range: **DPH-A□0** 0 to -101.3 kPa
DPH-A□2 0 to 1,000 MPa
DPH-A□7 -100.0 to 100.0 kPa
 Applicable fluid: Non-corrosive gas
 Supply voltage: 12 to 24 V DC $\pm 10\%$
 Analog voltage output: 1 to 5 V
 (over rated pressure range)
 Pressure port: **DPH-A0□** M5 male thread,
DPH-A1□ R (PT) 1/8 male thread / M5 female thread
DPH-A2□ NPT 1/8 male thread / 10-32UNF female thread
DPH-A30 10-32UNF male thread
 Dimensions: **DPH-A0□/A30** 12.5 × 25 × 20 mm
DPH-A1□/A2□ 12.5 × 25 × 25 mm

Pressure sensor controllers

Applicable pressure sensor head: **DPH-A□**
 Rated pressure range: Vacuum pressure 0 to -101.3 kPa
 Positive pressure 0 to 1,000 MPa
 Compound pressure -100.0 to 100.0 kPa
 Supply voltage: 12 to 24V DC $\pm 10\%$
 Comparative Output (Comparative output 1, Comparative output 2):
DP5-C NPN open-collector transistor
DP5-C-P PNP open-collector transistor
 Analog voltage output: 1 to 5 V DC (over rated pressure range)
 Dimensions: W40 × H20 × D43 mm

All information is subject to change without prior notice.



SUNX Limited

2431-1 Ushiyama-cho, Kasugai-shi, Aichi,
 486-0901, Japan
 Phone: +81-(0)568-33-7211
 FAX: +81-(0)568-33-2631

Overseas Sales Dept.

Phone: +81-(0)568-33-7861
 FAX: +81-(0)568-33-8591

<http://www.sunx.co.jp/>