

# ASF1400

## Bidirectional Mass Flow Meter

- \_ Unique dynamic range:  
0.01 sccm – 400 sccm
- \_ Outstanding resolution and accuracy
- \_ Ultra fast response time
- \_ Hysteresis & offset free
- \_ Calibrated & temperature compensated
- \_ RS-232 and SPI digital interface



Preliminary Information as of November 2001

### ASF1400 Product Summary

The ASF1400 Mass Flow Meter enables extremely accurate bidirectional measurement of gas flow over four orders of magnitude. Its leading performance is based on SENSIRION's unsurpassed CMOSens™ sensor technology. With CMOSens™, the on-chip sensor element forms an integrated whole with the amplification and A/D converter circuit. This results in superior resolution, fast response time and large dynamic range at lowest power consumption.

All measurement data is fully calibrated and temperature compensated by means of an internal microcontroller.

Mounted in rugged, chemically inert PBT housing the ASF1400 is suitable for a wide range of applications. Such include mass flow metering for process control, medical applications, heating ventilation and air conditioning (HVAC) solutions, as well as gas flow metrology.

The sensor housing provides two inlets for measuring the gas flow and withstands overpressures of 2 bar (29 psi).

The ASF1400 requires a supply voltage of 7...18Vdc and provides an RS-232 and SPI compliant electrical interface.

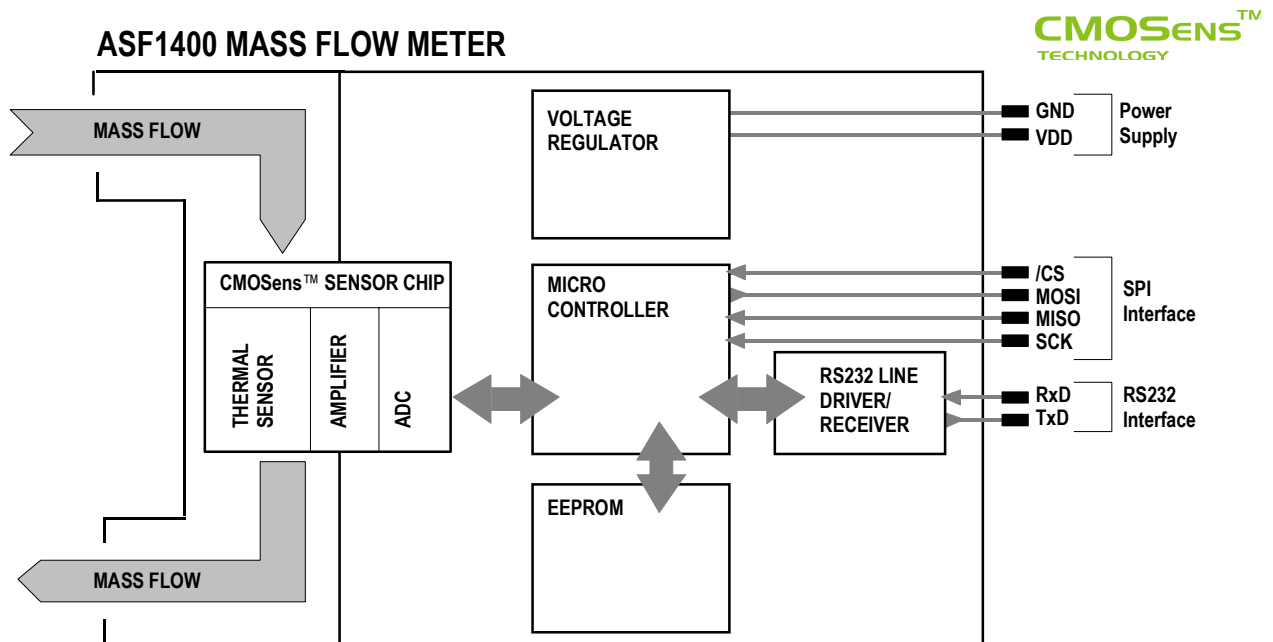

Figure 1: Block Diagram ASF1400 Mass Flow Sensor with CMOSens™ technology.

## Introductory Description

The heart of the ASF1400 mass flow meter is powered by Sensirion's unsurpassed CMOSens™ sensor technology. The ASF1400 mass flow meter therefore provides unbeatable performance at very attractive system cost. The lowest detectable gas flow rate is 0.003 sccm, which means a minimum volume of 3 mm<sup>3</sup> gas per minute can be measured. Covering at the same time a flow range of more than 4 orders of magnitude, the ASF1400 sets a new standard wherever mass flow has to be measured or controlled.

The ASF1400 device measures true mass flow independent of the ambient temperature and pressure changes. You simply connect the gas to be measured to the ASF1400 device to get an instantaneous gas flow rate at a sampling rate of up to 7Hz (please contact us for sampling rates of up to 200Hz).

A flow range between ±400 sccm can directly be measured by connecting the ASF1400. To increase the range, a bypass can be used in conjunction with the ASF1400 device (see Section 1.4 of this data sheet).

In addition to mass flow, the ASF1400 device provides information about the temperature on the CMOSens™ sensor element. Both mass flow and temperature data are accessed through an RS-232 or SPI interface. The RS-232 interface allows you to directly connect the ASF1400 device to a PC or PDA using standard terminal software. The serial peripheral interface (SPI) also enables the ASF1400 to be used in smaller systems. If a special interface such as 4-20 mA current output or other is required contact Sensirion for a customer specific solution.

In general, all gas types can be measured using the ASF1400 product. However, the standard calibration gas is nitrogen. Please contact SENSIRION, if you would like to use the sensor for applications with other gases.

To get you started quickly, an evaluation package including ASF1400 devices, software, cables, rubber hose and bypass is available from Sensirion AG.

## CMOSens™ sensor technology

CMOSens™ is the base technology for all Sensirion multi sensor modules and sensor systems. The unification of semiconductor chip and sensor technology serves as a platform for highly integrated system solutions with excellent sensor precision and reliability. With CMOSens™, the on-chip sensor element forms an integrated whole with a high-end amplification and A/D converter circuit. Due to the compact single-chip design, CMOSens™ based sensors are very resistant to electromagnetic disturbances (EMC), another important technical advantage of this state of the art sensor technology. As a result, CMOSens™ based multi sensor modules offer excellent sensor precision, fast response time and a very large dynamic measurement range. In addition, the digital intelligence of the CMOSens™ sensor technology enables digital interfaces that permit an easy link with the system of the customer, a real advantage and benefit that results in ready-to-use problem solutions ("Mount&Sense").

## 1 Mass Flow Sensor Performance

Table 1: Overview of ASF1400 Gas Sensor Performance

Parameter	Condition	Minimum	Typical	Maximum	Units
<b>Flow Sensor</b>					
Dynamic Range	direct measurement	-400		400	sccm <sup>(1)</sup>
	using proposed bypass tube <sup>(2)</sup>	-100		100	liter/min <sup>(3)</sup>
	customized bypass tube	unlimited		unlimited	
Resolution	400 sccm flow		0.09		sccm
	< 10 sccm flow		0.01		sccm
Lowest Detectable Flow	< 10 sccm flow		0.015 <sup>(4)</sup>	0.003 <sup>(4)</sup>	sccm
Pressure Drop	400 sccm, $p_{abs.} = 1$ bar		120		Pa <sup>(5)</sup>
Repeatability			0.0025 % FS <sup>(6)</sup> 0.025 % m.v.		
Accuracy	23 C	0...5 % of full scale		0.05 % FS <sup>(7)</sup>	
		5...100 % of full scale		1 % m.v. <sup>(7)</sup>	
Offset	23°C		< 0.005	< 0.02	% FS
Overpressure Resistance <sup>(8)</sup>				2	bar
Response Time <sup>(9)</sup>	depends on resolution setting (see Section 3, Table 2)	142		1280	ms
Operating Temperature		0		70	°C
Ambient Temperature Coefficient	Zero		< 0.005		% FS / °C
	Span		< 0.08		% measured value / °C
Position Sensitivity	$p_{abs}=1$ bar, small nitrogen flow		±0.008		% FS
<b>Temperature Sensor</b>	Measures temperature inside the sensor, but not of the surrounding air <sup>(10)</sup>				
Dynamic Range		0		70	°C
Resolution			0.1		°C
Accuracy		3	2		°C

### Notes:

All data for 23°C unless otherwise noted.

(1) 1 sccm = 1 cm<sup>3</sup>/min at 0°C and 1013mbar pressure (1sccm = 0.001 norm liter)

(2) using bypass tube included in Sensirion's mass flow meter evaluation kit EK-F1

(3) 1 liter/min = 1000 sccm

(4) 0.015 sccm is standard ASF1400, 0.003 sccm is available on request.

(5) 1 bar = 100 000 Pa = 0.9869 atm = 401.9 inch H<sub>2</sub>O = 14.5 psi

(6) Error = % of full scale (FS) or % of measured value, whichever is bigger.

(7) Better calibration available on request. Allow the Sensor to warm up for best results.

(8) Higher overpressure resistance can be realised in OEM-solutions.

(9) For faster response times please check out the ASF1430 high speed mass flow meter data sheet

(10) The sensor warms up by about 7°C (depending on supply voltage and ventilation).

### 1.1 Gas Flow Characteristics

Figure 2 shows the applied gas flow vs. the digital output of the ASF1400.

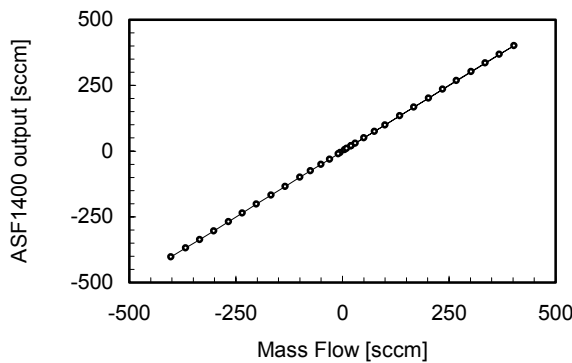

Figure 2: ASF1400 transfer characteristics.

### 1.2 Sensor Principle and Gas Types

The ASF1400 device detects mass gas flow by measuring heat transfer. A heating resistor on a thermally insulated membrane is kept above ambient temperature. In the presence of gas flow, the temperature distribution up- and downstream is disturbed. This asymmetry is then measured. Due to the minimal thermal mass of the membrane, symmetrical arrangement, and accurate temperature measurement, the revolutionary specifications of the ASF1400 devices are achieved.

The above mentioned thermal principle requires information about the gas type to be measured. The ASF1400 is available for air and nitrogen. Other gas types are available on request.

In Figure 3 the repeatability of the ASF1400 devices is compared with the repeatability of a typical Mass Flow Controller (MFC). It emphasizes the superior performance of the ASF1400 device.

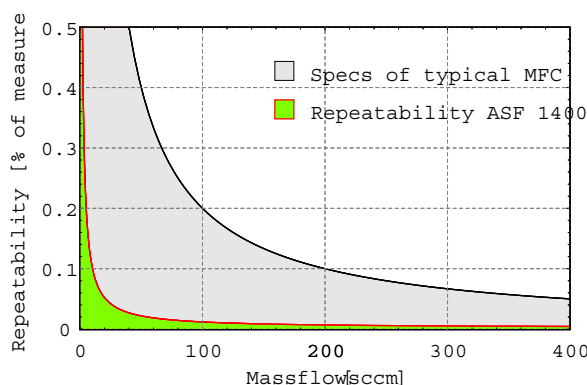

Figure 3: Comparison of the repeatability of the CMOSens™ ASF1400 device compared to a typical Mass Flow Controller (MFC).

### 1.3 Gas Flow and Pressure Difference

The ASF1400 is calibrated for mass flow measurements. However, there is a well defined relation between mass flow and pressure drop. This relation is shown in Figure 4. On request the ASF1400 can also be calibrated for the pressure drop at its output (for more details refer to the documentation of the Sensirion Differential Pressure Sensor ASP1400).

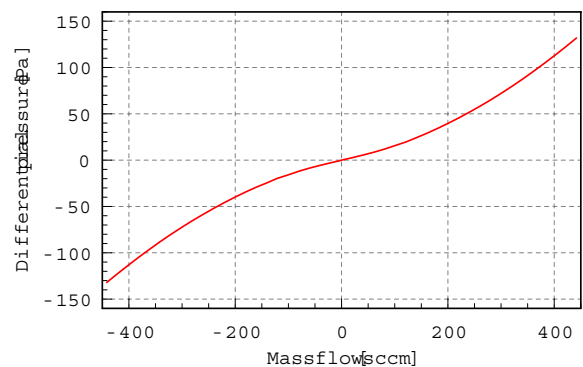

Figure 4: Differential Pressure vs. Mass Flow of ASF1400 Device.

### 1.4 Adjusting the Measurement Range

To adjust the measurement range, the ASF1400 device is used in conjunction with a bypass configuration (see Figure 5). Only a sample of the total flow actually gets directed through the bypass channel and the sensor system. A tube with flow restrictor and all required connection items are included in the Mass Flow Meter Evaluation Kit EK-F1, also available from SENSIRION AG.

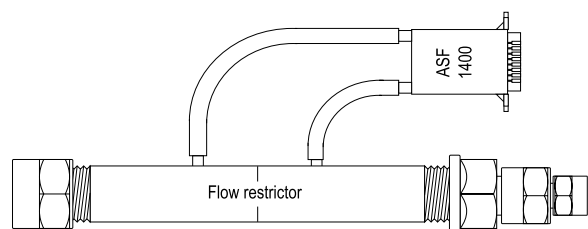

Figure 5: Extending the measurement range of the ASF1400 device using a bypass configuration. Only a sample of the total flow actually gets directed through the bypass channel and the sensor. Shown tube with flow restrictor is included in the EK-F1 evaluation kit.

## 2 Pins and Digital Interface

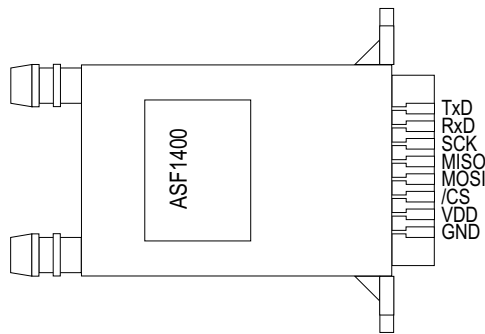

Figure 6: ASF1400 pin out.

### GND and VDD (Power Supply)

The ASF1400 requires a voltage supply of between 7 V and 18 V. Since this voltage is internally regulated, there are no stringent requirements as far as ripple and stability are concerned.

### 2.1 RS-232 Interface

All configurations (see also Section 3) for the ASF1400 can be set using its RS-232 interface). To communicate with the ASF1400 via RS-232 the following pins are required:

- RxD** (Receiving Data Line)
- TxD** (Transmitting Data Line)
- GND** (Ground)

The RS-232 of the ASF1400 is configured as follows:

Baudrate	9600
Data Bits	8
Stop Bits	1
Parity	none
Protocol	none

With these settings, the ASF1400 device can be connected to any PC or PDA equipped with terminal software.

The measurement values are provided as a signed floating point number together with the corresponding unit (**sccm** for mass flow, **C** for temperature). In case of an overflow, the output shows **oF**.

### 2.2 Serial Peripheral Interface (SPI)

To make measurement data available also for smaller systems or to cascade several ASF1400 devices, the ASF1400 provides a uni-directional SPI interface.

The configuration of the ASF1400 (as described in Section 3) has to be done using the RS-232 port. The SPI interface provides the measurement data as a 24 bit signed integer, where bit 0...22 defines the value and bit 23 the sign (0 indicates the positive, and a 1 the negative sign). The 24 bits are transmitted in 3 blocks, each consists of one byte. The MSB (bit 23) is sent first.

Since the calibrated mass flow and temperature output values of the ASF1400 sensor have floating point precision, the transmitted integer data is multiplied with an SPI factor. This factor is 100. Example: a received flow SPI value of +1234 corresponds to a flow of 12.34 sccm. Figure 7 shows the internal setup of the SPI interface lines and Figure 8 an example of cascading four ASF1400 devices using a single microcontroller.

Note: With each additional sensor the capacitive load will increase, causing an increase of the output fall/rise time and an output signal deterioration.

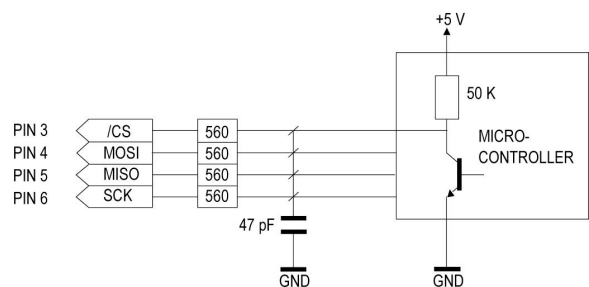

Figure 7: Internal ASF1400 SPI hardware.

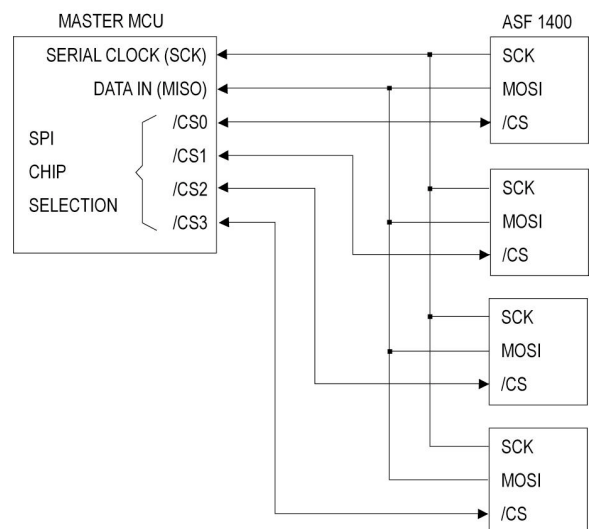

Figure 8: Cascading four ASF1400 devices using the SPI interface.

### SCK (Serial Clock, Output)

The SCK synchronizes data transfer out of the device through the MOSI line. Data on the MOSI pin is ready after a falling edge of SCK (see Figure 9 and 10 for details).

### /CS (Chip Select, Input or Output)

There are two SPI modes, namely the PUSH and the GET mode. In PUSH mode the /CS pin is controlled by the ASF1400 device which behaves like a master. Low going /CS announces a new data transfer (see also Section 4.3).

In GET mode the data transfer is initiated externally by pulling /CS low. In this case, as soon as the measurement data is ready, it appears on the MOSI pin.

### MOSI (Master Out Slave In, Output)

MOSI is the serial data output of the ASF1400 device. Data is clocked out on the rising edge SCK with MSB first. This output goes into a high-impedance state when the device is not selected.

### MISO (Master In Slave Out, Not Connected)

The ASF1400 firmware only supports a uni-directional SPI protocol. Therefore, the MISO pin should always left unconnected.

## 3 Configuration and Commands

The ASF1400 device accepts a set of commands through its RS-232 interface (see table 3 for valid commands; for correct settings of the RS-232 refer to Section 2.1). This allows the user to configure the ASF1400 device. Since the configuration is stored in the internal EEPROM, it is maintained after power breaks.

With the exception of the stop **s** command, all commands have to be terminated by the return key (↵, ASCII #10 or

#13). After completion of a command, the ASF1400 returns **ok** and is ready to take a new instruction. Before entering a command, it may be necessary to clear the buffer by means of using ↵.

There is a trade-off between resolution and measurement time. Possible settings are listed in Table 2. Choosing 12 bit results in a measurement interval of 142 ms. With the max resolution of 15.2 bit, a new measurement is provided every 1280 ms. For faster sampling rates refer to the ASF1430 high speed mass flow meter device data sheet.

Table 2: Resolution settings using the **res=value** command and corresponding response times

res=	Resolution [bit]	data interval [ms]
1	12.0	142
2	13.0	284
3	13.5	427
4	14.0	569
5	14.3	711
6	14.6	853
7	14.8	995
8	15.0	1138
9	15.2	1280

Table 3: Commands of the ASF1400 device.

Command	Output	Description
help↵	commands	Lists all available commands
ver↵	version	Provides type of sensor, software, hardware and customer version
get↵		Start single measurement
go↵		Starts series of measurements
s	stop	Stops series of measurements
reset↵		Resets ASF1400 device
res=1..9↵	resolution	Sets resolution: 1 -> 12 bits; 9 -> 15 bits, see Table 2
res?	resolution	Shows actual setting
mod=F   T↵	mode	Selects Flow- (F) or Temperature mode (T)
mod?	mode	Shows actual setting
Disp=s,d	display mode	Shows Flow (s) or Flow+Temperature (d) *no effect in the Temperature mode
Disp?	display mode	Shows actual setting
defspi=P   G↵	define spi	Sets SPI in Push- (P) or Get mode (G), see also Section 4.3

#### Notes:

- Default settings are marked in **bold** letters
- The commands are not case sensitive.
- In order to send a new command to the ASF1400 make sure the ASF1400 is not in measurement mode. Issue therefore a stop command **s** first. After this, any instruction can be given to the ASF1400 and a new series of measurement can be started by **go↵**.
- Due to the limited write cycles allowed for the EEPROM, excessive configuration modifications should be avoided.

## 4 Specifications ASF1400

### 4.1 Absolute Maximum Ratings

Ambient storage temperature	-65°C to 150°C
Ambient operating temperature	0°C to 70°C
Overpressure resistance	2.0 bar

### 4.2 Electrical Specifications

Table 3: ASF1400 DC Characteristics.

Parameter	Conditions	Min.	Typ.	Max.	Units
Power Supply DC	DC	7	9	18	V
Operating Current	VDD = 9 V, no load		20		mA
	VDD = 9 V, 3k $\Omega$ at RS232 output		27		mA
Power Dissipation	VDD = 9 V, no load		180		mW

Table 4: ASF1400 RS-232 Characteristics.

Parameter	Conditions	Min.	Typ.	Max.	Units
<b>RS232 Output</b>					
Output Voltage Swing	Transmitter output loaded with 3k $\Omega$	$\pm 5$	$\pm 9$		V
Power-Off Output Resistance		300			$\Omega$
Output Short Circuit Current			$\pm 18$		mA
<b>RS-232 Input</b>					
Voltage Range		-15		15	V
Voltage Threshold					
Low		0.8	1.2		V
High			1.7	2.4	V
Hysteresis		0.2	0.5	1.0	V
Resistance		3	5	7	k $\Omega$



Table 5: ASF1400 SPI Characteristics (refer to Figure 9 for a timing diagram).

Symbol	Parameter	Conditions	Min.	Typ.	Max.	Units
V <sub>ol</sub>	Output Low Voltage	not connected	0	0.2	0.4	V
V <sub>oh</sub>	Output High Voltage	not connected	4.8	4.9	5	V
V <sub>ol</sub>	Output Low Voltage	RI=100k $\Omega$	0	0.2	0.5	V
V <sub>oh</sub>	Output High Voltage	RI=100k $\Omega$	2.4	4.45		V
I <sub>oh</sub>	Output High Current	V <sub>dd</sub> = 5V		-60		$\mu$ A
I <sub>ol</sub>	Output Low Current	V <sub>dd</sub> = 5V		0.3		mA
f <sub>op</sub>	SCK Frequency			87		kHz
t <sub>ro</sub>	Output Rise Time	not connected		40		ns
t <sub>fo</sub>	Output Fall Time	not connected		26		ns
t <sub>ro</sub>	Output Rise Time	RI=100k $\Omega$		42		ns
t <sub>fo</sub>	Output Fall Time	RI=100k $\Omega$		30		ns
t <sub>clh</sub>	Clock High Time			5.70		$\mu$ s
t <sub>cll</sub>	Clock Low Time			5.80		$\mu$ s
t <sub>css</sub>	/CS Setup Time		15.0		27.0	$\mu$ s
t <sub>st</sub>	Send Time				930	$\mu$ s

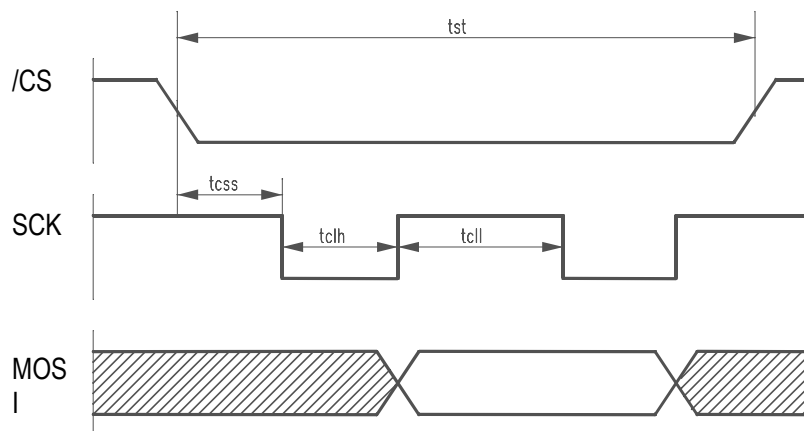

Figure 9: Timing Diagram of the ASF1400 SPI Interface.



### 4.3 SPI Push-Mode Detailed Description

The subsequent scope diagrams further describe the ASF1400 device SPI mode data access protocol in PUSH mode.

- 1 = SCK            Serial clock output
- 2 = /CS          Chip select (Push-Mode)
- 3 = MOSI        Serial data output

Complete read cycle (three bytes)

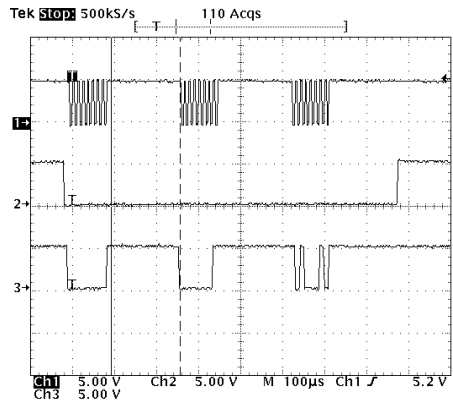

Close up of one byte

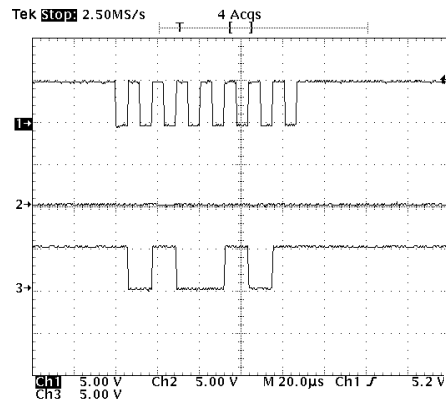

First byte

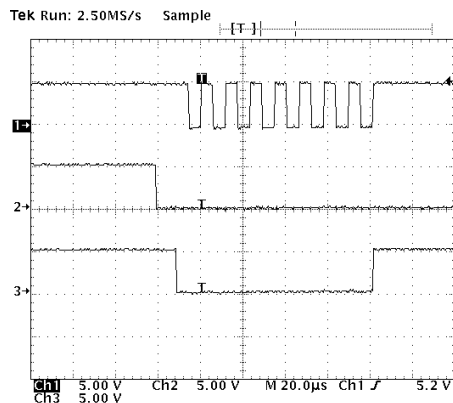

Third byte

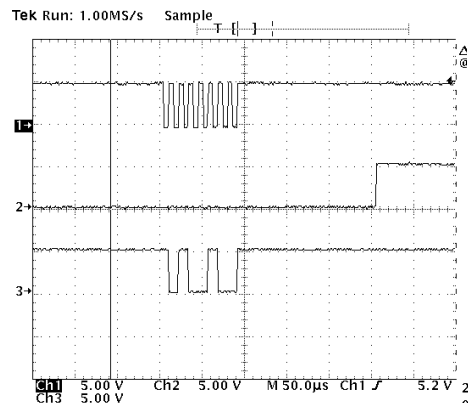

Figure 10: Sample for SPI read cycle of the ASF1400 in Push Mode.

## 5 Physical Dimensions and Mounting Information

The ASF1400 is mounted in chemically inert PBT housing. The rugged package has been designed to withstand overpressures of up to 2 bars. Higher pressure packages of up to 10 bars are available on request.

Physical dimensions and mounting information are provided in Figure 11 and Table 6.

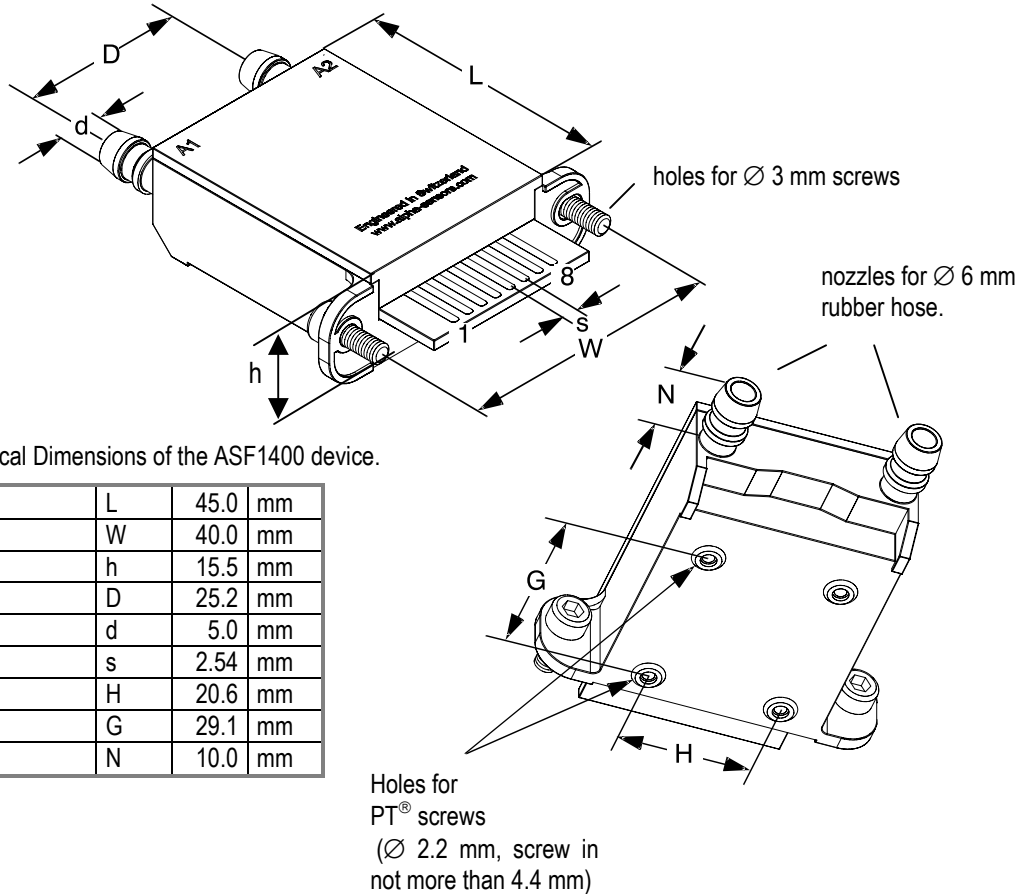

Table 6: Physical Dimensions of the ASF1400 device.

Length	L	45.0	mm
Width	W	40.0	mm
Height	h	15.5	mm
Distance	D	25.2	mm
Diameter	d	5.0	mm
Pitch	s	2.54	mm
Pitch	H	20.6	mm
Pitch	G	29.1	mm
Pitch	N	10.0	mm

Figure 11: Physical dimensions and mounting information of the ASF1400.

## 6 Ordering Information

For small ordering quantities the ASP1400 sensor can be ordered directly at Farnell on <http://www.farnell.com>. Farnell is a worldwide distributor of electrical, electronic and industrial component products.

When ordering ASF1400 series devices at SENSIRION please refer to the following part numbers. For the latest product information access SENSIRION's website on <http://www.sensirion.com>

Calibrated for Gas Type	Range	Packaging	Part Number
Nitrogen	± 400 sccm	2 bar	1-100011
Other gas types on request	± 400 sccm	2 bar	-

### Notes:

- Packages to sustain common mode pressures of 10 bars are available on request.
- Special electrical interfaces such as 4-20 mA output or others are available on request.
- For faster response times refer to the ASF1430 data sheet.
- A evaluation kit including ASF1400 devices, evaluation software and other accessories such a bypass, rubber hose and cables can be ordered. For detailed information check out the description of the Mass Flow Meter Evaluation Kit EK-F1 on <http://www.sensirion.com>

## IMPORTANT NOTICES

The warranty for each SENSIRION AG product comes in the form of a written warranty which governs sale and use of such product. Such warranty is contained in the printed terms and conditions under which such product is sold, or in a separate written warranty supplied with the product. Please refer to such written warranty with respect to its applicability to certain applications of such product.

These products may be subject to restrictions on use. Please contact SENSIRION AG for a list of the current additional restrictions on these products. By purchasing these products, the purchaser of these products agrees to comply with such restrictions. Please contact SENSIRION AG for clarification of any restrictions described herein.

SENSIRION AG reserves the right, without further notice, to change the SENSIRION ASF1400 Mass

Flow product specifications and/or information in this document and to improve reliability, functions and design.

SENSIRION AG assumes no responsibility or liability for any use of SENSIRION ASF1400 product. Application examples and alternative uses of the SENSIRION ASF1400 are for illustration purposes only and SENSIRION AG makes no representation or warranty that such applications shall be suitable for the use specified.

SPI is a trademark of Motorola. LabView is a trademark of National Instruments.

Copyright© 2001, SENSIRION AG. All rights reserved.

---

## FCC and CE Statement

The ASF1400 product has been tested and found to comply with the limits for a Class B digital device, pursuant to part 15 of the FCC Rules (FCC CFR 47). These limits are designed to provide reasonable protection against harmful interference in a residential installation. This equipment generates, uses and can radiate radio frequency energy and, if not installed and used in accordance with the instructions, may cause harmful interference to radio communications. However, there is no guarantee that interference will not occur in a particular installation. If this equipment does cause harmful interference to radio or television reception, which can be determined by turning the equipment off and on, the user is encouraged to try to correct the interference by one of more of the following measures:

- Reorient or relocate the receiving antenna.

- Increase the separation between the equipment and the receiver
- Connect the equipment into an outlet on a circuit different from that to which the receiver is connected.
- Consult a dealer or an experienced radio/TV technician for help.



The ASF1400 device fully complies with norm EN 50081-2 (Emission Test Series) as well as EN 50082-2 (Immunity Test Series).

---

## Headquarters and Sales Office

SENSIRION AG      Phone: + 41 (0)1 306 40 00  
Eggbühlstr. 14      Fax: + 41 (0)1 306 40 30  
P.O. Box            e-mail: [info@sensirion.com](mailto:info@sensirion.com)  
CH-8052 Zürich      <http://www.sensirion.com/>  
Switzerland