

NUMBER GS-12-192	TYPE PRODUCT SPECIFICATION		
TITLE GIG-ARRAY® High Speed Mezzanine Connectors 15-35 mm Board to Board		PAGE 1 of 15	REVISION G
		AUTHORIZED BY D. Harper	DATE 20 OCT 07
CLASSIFICATION UNRESTRICTED			

1.0 OBJECTIVE

This specification defines the performance, test, quality, and reliability requirements of the GIG-ARRAY® High Speed Mezzanine 1.00 x 0.65 mm BGA Differential Connector System. This specification applies for Eutectic SnPb BGA as well as Lead Free SnAgCu BGA product that meets the requirements of the European Union Directive of Restrictions for Hazardous Substances (Directive 2002/95/EC).

2.0 SCOPE

This specification applies to the GIG-ARRAY® High Speed Mezzanine Differential Connector, which provides for interconnection of parallel printed wiring boards in low power applications.

3.0 GENERAL

<u>PARAGRAPH</u>	<u>TITLE</u>
1.0	Objective
2.0	Scope
3.0	General
4.0	Applicable Documents
5.0	Requirements
5.1	Qualification
5.2	Material
5.3	Finish
5.4	Design and Construction
6.0	Electrical Characteristics
7.0	Mechanical Characteristics
8.0	Environmental Conditions
9.0	Quality Assurance Provisions
9.1	Equipment Calibration
9.2	Inspection Conditions
9.3	Sample Quantities and Description
9.4	Acceptance
9.5	Qualification Testing
9.6	Requalification Testing

4.0 APPLICABLE DOCUMENTS

4.1 DRAWINGS & APPLICATION NOTE

4.1.1	<u>296 Position Connectors</u>	
	55720	Plug, 10mm
	10026804	Plug, 12mm
	10060911	Plug, 13mm
	10055143	Plug, 13mm
	55700	Plug, 15mm
	55727	Plug, 20mm
	10054784	Plug, 25mm
	55701	Receptacle, 5mm
	10060913	Receptacle, 15mm

NUMBER GS-12-192	TYPE PRODUCT SPECIFICATION		
TITLE GIG-ARRAY® High Speed Mezzanine Connectors 15-35 mm Board to Board		PAGE 2 of 15	REVISION G
		AUTHORIZED BY D. Harper	DATE 20 OCT 07
		CLASSIFICATION UNRESTRICTED	

200 Position Connectors

55737	Plug, 10mm
10026802	Plug, 12mm
10060910	Plug, 13mm
10055142	Plug, 13mm
55738	Plug, 15mm
55739	Plug, 20mm
10054783	Plug, 25mm
55740	Receptacle, 5mm
10060912	Receptacle, 15mm

4.1.2 Application Specification: GS-20-016

4.2 OTHER STANDARDS AND SPECIFICATIONS

4.2.1 UL-94: Flammability

4.2.2 EIA 364: Electrical Connector/Socket Test Procedures Including Environmental Classifications

4.2.3 ASTM B194: Beryllium Copper Alloy

4.2.4 ANSI/J-STD-005: Requirements for Soldering Pastes

4.2.5 ANSI/J-STD-004: Requirements for Soldering Fluxes

4.2.6 ASTM B827-92: Flowing mixed gas Corrosion Test

4.2.7 ANSI-J-002: Solderability Tests for Component Leads, Terminations, Lugs, Terminals & Wires (paragraph 3.4.2 Steam Aging)

4.2.9 8EIA-638 - Surface Mount Solderability Test

4.3 FCI SPECIFICATIONS

4.3.1	BUS-15-002/M	Nickel Plating
4.3.2	BUS-16-007	Beryllium Copper Strip
4.3.3	BUS-16-831	High Strength Copper Alloy
4.3.4	BUS-16-068	Liquid Crystal Polymer
4.3.5	BUS-15-005/H	Gold Plating
4.3.6	GES-14-777	Packaging of GIG-ARRAY® Product
4.3.7	BUS-19-125	MEG Array Connector 3 Point Bend Test Procedure
4.3.8	BUS-03-108	Cross talk Test Methods

NUMBER GS-12-192	TYPE PRODUCT SPECIFICATION		
TITLE GIG-ARRAY® High Speed Mezzanine Connectors 15-35 mm Board to Board		PAGE 3 of 15	REVISION G
		AUTHORIZED BY D. Harper	DATE 20 OCT 07
		CLASSIFICATION UNRESTRICTED	

4.3.9	BUS-03-117	Eye Pattern Measurement
4.3.10	BUS-03-110	Characteristic Impedance
4.3.11	BUS-03-111	Propagation Delay Measurements
4.3.12	BUS-03-113	Inductance Measurement
4.3.13	GES-18-015	Product Quality Plan
4.3.14	GES-31-002	Workmanship STD & Insp. Instruction
4.3.15	BUS-03-601	Current Rating

5.0 REQUIREMENTS

- 5.1 QUALIFICATION Connectors furnished under this specification shall be products that are capable of meeting the qualification test requirements specified herein.
- 5.2 MATERIAL The material for each part shall be as specified herein, or equivalent. Substitute material shall meet the performance requirements of this specification.
- 5.2.1 Receptacle Terminal The base material shall be high strength copper alloy strip.
- 5.2.2 Plug Terminal The base material shall be high strength copper alloy strip.
- 5.2.3 Plug and Receptacle Insulator Housing The insulators shall be molded using liquid crystal polymer that is rated 94V-0 or better in accordance with UL-94.
- 5.2.4 Solder Balls alloy 63 Tin/37 Lead or Lead Free 95.5Sn/4Ag/.5Cu
- 5.2.5 Solder Paste Modified low resin content, no clean, with 63SN/37PB solder or Lead Free 95.5Sn/4Ag/.5Cu solder.
- 5.3 FINISH
- 5.3.1 The plug and receptacle terminals shall be plated in the contact area with 0.76 micrometers min. gold over 1.27 micrometers nickel.
- 5.4 DESIGN AND CONSTRUCTION The connector shall be a multi-piece assembly having an array of contacts with solder balls attached, for installation on surface mount printed wiring boards or flexible circuits.
- 5.4.1 Mating. The connector shall be capable of mating and unmating manually without the use of special tools.

6.0 ELECTRICAL CHARACTERISTICS

- 6.1 Contact Resistance, Low-Level (LLCR) - The initial low-level contact resistance of signal contacts and ground circuits shall not exceed (See Below), with a max.10 milliohms change after environmental exposure, when measured in accordance with EIA 364-23. The following details shall apply:

NUMBER GS-12-192	TYPE PRODUCT SPECIFICATION		
TITLE GIG-ARRAY® High Speed Mezzanine Connectors 15-35 mm Board to Board		PAGE 4 of 15	REVISION G
		AUTHORIZED BY D. Harper	DATE 20 OCT 07
		CLASSIFICATION UNRESTRICTED	

- a)
- | | |
|----------------------|---|
| 15 mm mated height | 20 milliohms |
| 18 mm mated height | 23 milliohms |
| 20 mm mated height | 24 milliohms |
| 25 mm mated height | 28 milliohms |
| 28 mm mated height | 31 milliohms |
| 30 mm mated height | 32 milliohms |
| 35 mm mated height | 36 milliohms |
| 40 mm mated height | 40 milliohms |
| Method of Connection | Attach current and voltage leads as shown in Figure 1. |
| Test Voltage | 20 millivolts DC max open circuit |
| Test Current | Not to exceed 100 milliamperes. |
| Delta LLCR | 3% maximum >5 mΩ, 1% maximum >10mΩ and none >50mΩ. |
| Sample Size | 500 mated signals minimum and 250 mated ground pairs min. |

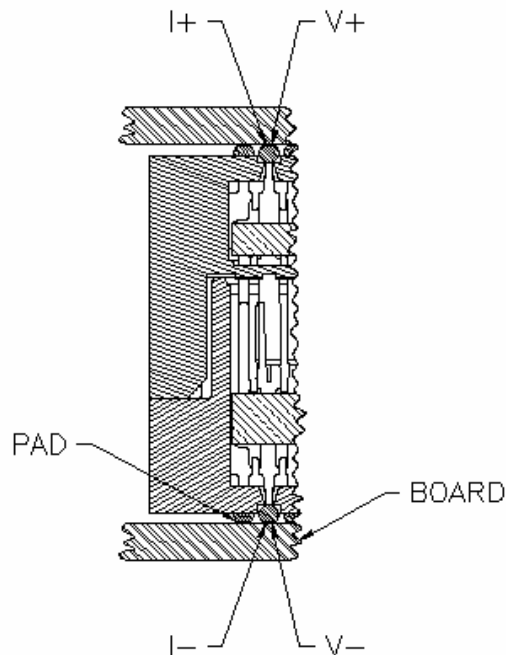



FIGURE 1

LLCR Measurement Points

NUMBER GS-12-192	TYPE PRODUCT SPECIFICATION		
TITLE GIG-ARRAY® High Speed Mezzanine Connectors 15-35 mm Board to Board		PAGE 5 of 15	REVISION G
		AUTHORIZED BY D. Harper	DATE 20 OCT 07
CLASSIFICATION UNRESTRICTED			

- 6.2 Insulation Resistance - The insulation resistance of mated connectors shall not be less than 5000 megohms (1000 megohms after environmental exposure) when measured in accordance with EIA 364-21. The following details shall apply:
- Test Voltage - 500 volts DC.
 - Electrification Time – 60 seconds minimum.
 - Points of Measurement - 10 signal-signal pair and 10 signal-to-adjacent ground contacts shall be tested in each mated connector pair.
- 6.3 Dielectric Withstanding Voltage - There shall be no evidence of arc-over, insulation breakdown, or excessive leakage current (> 1 milliampere) when mated connectors are tested in accordance with EIA 364-20. The following details shall apply:
- Test Voltage - 500 volts DC.
 - Test Duration - 60 seconds minimum.
 - Test Condition - 1 (760 Torr - sea level).
 - Points of Measurement - 10 signal-signal pair and 10 signal-to-adjacent ground contacts shall be tested in each mated connector pair.
- 6.4 Current Rating - The temperature rise above ambient shall not exceed 30 °C at any point in the system when all contacts in three adjacent wafers are powered with up to 1.00 ampere and 3.5 amps for 3 contacts in the same area. The following details shall apply:
- Ambient Conditions - Still air at 25 ± 5°C.
 - Reference - BUS-03-601.
 - Plot temperature rise vs. current per BUS-03-601.
 - Plug and receptacle connectors shall be soldered to boards. When the connectors are mated, the board traces shall serially interconnect all the signal and ground contacts of three adjacent wafers.
 - Thermocouple shall be located near the interface of the center contact on the center wafer.
- 6.5 Capacitance (Simulated) - The capacitance, at 100 kHz, between adjacent contacts in a mated connector has been shown through electrical simulation not exceed values shown in following table.

<u>Mated Connector Height</u>	<u>Capacitance (pF)</u>
15mm	0.46
18mm	0.54
20mm	0.61
25mm	0.69
28mm	0.78
30mm	0.83
35mm	0.92
40mm	1.03

NUMBER GS-12-192	TYPE PRODUCT SPECIFICATION		
TITLE GIG-ARRAY® High Speed Mezzanine Connectors 15-35 mm Board to Board		PAGE 6 of 15	REVISION G
		AUTHORIZED BY D. Harper	DATE 20 OCT 07
		CLASSIFICATION UNRESTRICTED	

6.6 Single Ended Propagation Delay - The propagation delay shall not exceed values shown below when evaluated in accordance with FCI Test Specification BUS-03-111. The following details shall apply:

a) Specification requirement:

<u>Mated Connector Height</u>	<u>Propagation Delay (pS)</u>
15mm	55
18mm	75
20mm	90
25mm	110
28mm	115
30mm	120
35mm	135
40mm	160

6.7 Differential Characteristic Impedance - The specification requirement shall be satisfied when evaluated in accordance with FCI Test Specification BUS-03-110 and the following details:

- a) Input Rise Time (10% to 90%) = 100ps
- b) Contacts tested as differential pairs
- c) Specification requirement 100 +10 / -15 ohms
- d) Exception to 40mm stack height 100 +15 / -10 ohms

6.8 Multi-Active Differential Crosstalk - The specification requirement shall be satisfied when evaluated in accordance with FCI Test Specification BUS-03-108 and the following details:

- a) Input Rise Time (10% to 90%) = 100ps
- b) Near End Crosstalk: 3% max.
- c) 1:1 Signal to Ground Ratio

6.9 Partial Self Inductance (Simulated) - The Partial Self Inductance has been shown through electrical simulation not exceed values shown in following table.

a) Specification requirement.

<u>Product mated height</u>	<u>Inductance (nH)</u>
15mm	10.4
18mm	13.1
20mm	14.8
25mm	19.8
28mm	23.0
30mm	25.1
35mm	30.1
40mm	35.2

NUMBER GS-12-192	TYPE PRODUCT SPECIFICATION		
TITLE GIG-ARRAY® High Speed Mezzanine Connectors 15-35 mm Board to Board		PAGE 7 of 15	REVISION G
		AUTHORIZED BY D. Harper	DATE 20 OCT 07
		CLASSIFICATION UNRESTRICTED	

6.10 Differential Eye Pattern: - The specification requirement shall be satisfied when evaluated in accordance with FCI Test Specification BUS-03-117 and the following details:

- a) Test Board shall have the following characteristics:
- 1) Trace Length = 46.0 ± 0.25 mm
 - 2) Finished hole size = 0.25 mm diameter.
 - 3) Board material = Rogers 4003 ($\epsilon_r = 3.38$, $\text{Tan } \delta = .0027$)
 - 4) Edge coupled traces. Width = 0.15 mm and space between traces = 0.18 mm
 - 5) Trace impedance = 100Ω differential.
- b) When a pseudo-random 2^7-1 signal of 10 Gb/s is used, the eye opening, in accordance with Figure 2, shall have a rectangular mask width of at least 40% of the bit time when the height is 25% of the differential amplitude, $W_{(H=25\%)} \geq 40\%$.

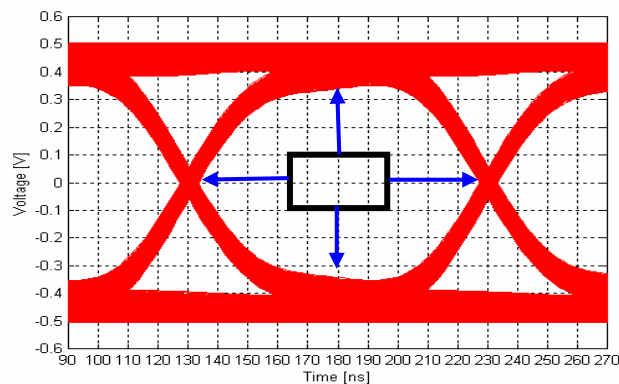



Figure 2 – Differential Eye Opening

NUMBER GS-12-192	TYPE PRODUCT SPECIFICATION		
TITLE GIG-ARRAY® High Speed Mezzanine Connectors 15-35 mm Board to Board		PAGE 8 of 15	REVISION G
		AUTHORIZED BY D. Harper	DATE 20 OCT 07
		CLASSIFICATION UNRESTRICTED	

7.0 MECHANICAL CHARACTERISTICS

7.1 Mating/Unmating Force - Both plug and receptacle shall be soldered onto boards and the boards held in place by adequate fixturing to prevent cocking or misalignment. Measurements are recorded for 3 consecutive mate/unmate cycles and the highest and lowest of those three measurements shall meet the requirements specified below.

- a) Cross Head Speed – 12.7 – 25.4 mm per minute.
- b) Lubrication - None

7.1.1 Total Mating Force

	<u>200 Pos.</u>	<u>296 Pos.</u>
The Average mating force shall be:	14.5 Kgms	21.8 Kgms

7.1.2 Withdrawal Force

	<u>200 Pos.</u>	<u>296 Pos.</u>
The min. total un-mating force shall be:	3.0 Kgms	5.4 Kgms

7.2 3-Point Bend – The connectors are soldered onto an 0.062” thick FR-4 bd. With pad geometry and footprint per FCI Customer drawing and Application Specification GS-20-016. The board is fixtured and bowed 20 mils/inch of board support distance (see Figure 3). Dye penetrant is applied to solder joints and dried. Connector is pried off board and solder joints are visually inspected for cracks that occurred during bending. Per BUS-19-125 3-Point Bend Procedure.

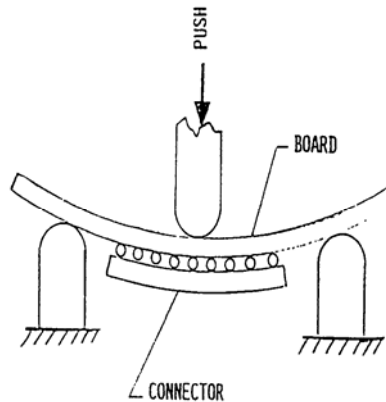



FIGURE 3 – 3-Point Bend Test

NUMBER GS-12-192	TYPE PRODUCT SPECIFICATION		
TITLE GIG-ARRAY® High Speed Mezzanine Connectors 15-35 mm Board to Board		PAGE 9 of 15	REVISION G
		AUTHORIZED BY D. Harper	DATE 20 OCT 07
		CLASSIFICATION UNRESTRICTED	

7.3 Contact Normal Force – Prior to test, measure contact overlap (CO) and calculate total contact deflection $TCD = CO + 0.20$ mm. When contact tines are deflected TCD mm and tested in accordance with BUS-03-404, the contact normal force shall be greater than 50 grams initial and 40 grams final. To expose contacts, receptacle connectors shall have cover removed prior to testing. Contacts will be tested in pairs, 1S-8S as shown in figure 4. Two wafers per connector (16 pairs) shall be tested.

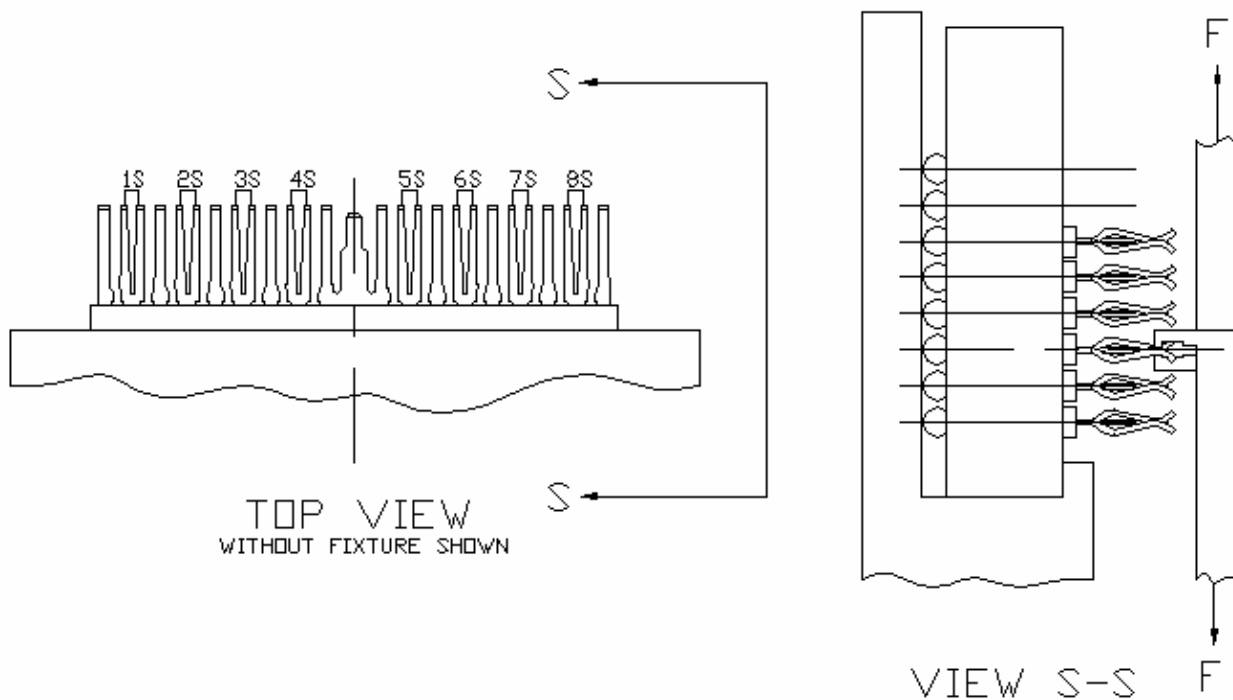



FIGURE 4 Contact Normal Force Test

NUMBER GS-12-192	TYPE PRODUCT SPECIFICATION		
TITLE GIG-ARRAY® High Speed Mezzanine Connectors 15-35 mm Board to Board		PAGE 10 of 15	REVISION G
		AUTHORIZED BY D. Harper	DATE 20 OCT 07
		CLASSIFICATION UNRESTRICTED	

ENVIRONMENTAL CONDITIONS

After exposure to the following environmental conditions in accordance with the specified test procedure and/or details, the product shall show no physical damage and shall meet the electrical and mechanical requirements as specified in the Table 1 test sequence. Unless specified otherwise, assemblies shall be mated during exposure.

8.1. Temperature Cycling – Samples can be one or more nets wired in series.

- a) Number of samples- 30 mated pair
- b) Temperature Range – Between 0 and 100 ± 5°C. Temperature shall be measured and recorded with a thermocouple mounted on the board as close as possible to the center of the ball pattern.
- c) Temperature ramp < 20°C/minute (<10°C/minute preferred).
- d) Dwell at each temp extreme- 15 minutes min. after PCB reaches temperature.
- e) Time for Each Cycle – approx. 60 minutes (24 test cycles per day)
- f) Connectors will be tested until 63.2% of the connectors (18 connectors) have failed or until 2670 cycles have been completed.
- g) Any measured resistance exceeding 100% increase in total resistance from initial value (recorded at hot temperature), shall be considered an open. An open followed by ten additional opens shall be considered a failure. The time to failure shall be recorded as the first open cycle of the failure sequence.

8.2 Humidity/Temperature Cycling – EIA-364-31, Method III exception 10-hour cycle.

Connectors shall be tested at elevated humidity and temperature shall be varied as specified below.

- a) Relative Humidity 95%
- b) Temperature range between +25°C and +65°C
- c) Exclude steps 7A and 7B
- d) Temperature ramp 1 hour/transition
- e) Temperature dwell 3 hours minimum at +65°C
- f) Time for each cycle- approx. 10 hours
- g) Number cycles – 50 (500 hour test)
- h) Connectors shall be mated.

8.3 High Temperature Life – EIA-364-17

- a) Test Temperature – 85 °C
- b) Test Duration – 500 hours

8.4 Thermal Shock-EIA-364-32

A minimum of 3 connectors shall be mated and monitored for event detection > 1 microsecond.

- a) Temperature range between -55°C and +85°C
- b) Temperature transfer rate, < 1 minute
- c) Temperature dwell, 30 minutes at each temperature extreme
- d) Number cycles, 5
- e) Connectors shall be mated.

NUMBER GS-12-192	TYPE PRODUCT SPECIFICATION		
TITLE GIG-ARRAY® High Speed Mezzanine Connectors 15-35 mm Board to Board		PAGE 11 of 15	REVISION G
		AUTHORIZED BY D. Harper	DATE 20 OCT 07
		CLASSIFICATION UNRESTRICTED	

8.5 Corrosive Atmosphere – EIA-364-65 (Serial Method)

After initial LLCR and 50% durability cycles, connectors will be broken into two groups of five. The plugs from the first group and the receptacles from the second group, shall be placed in the chamber unmated for 10 days. After 5 days unmated exposure, mate and recheck LLCR, then unmate and finish initial 10 days. Mate, recheck LLCR and then leave in chamber for 10 days mated. After 5 days mated exposure, recheck LLCR, and then return to chamber for final 5 days mated exposure.

Connectors shall be mounted to the appropriate printed wiring board(s) and exposed to mixed gas atmosphere in the test chamber of a sufficient volume to result in saturation of the test chamber.

- a) Relative humidity: 70% ± 2%
- b) Exposure Time: 2 x 5 days, with both plug and receptacle run concurrently.
- c) Temperature: 30° C ± 1° C
- d) Average Corrosion Rate: 15 ± 3 micrograms per sq. cm-day
- e) Gas Parameters: 200 ± 50 ppb NO₂, 10 ± 5 ppb H₂S, 10 ± 3 ppb CL₂, 100 ± 20 ppb SO₂

8.6 Durability – EIA 364-09

The connector pairs shall be mated/unmated 25 times total. The first 13 cycles are performed prior to specific environmental test in the sequence. The remaining 12 cycles are performed after environmental test. The test shall be performed with plug and receptacle soldered to board.

8.7 Mechanical Vibration: EIA-364-28

Five connectors shall be monitor for event detection > 1 microsecond.

- a) Type: Sinusoidal, 10 to 500 Hz, 10g (Total frequency traverse time 15 min.)
- b) Direction: Along each of three mutually perpendicular axis.
- c) Time: 8 hours per axis (24 hours total)
- d) After completion of test in all three axis, connector shall meet post environmental LLCR requirement.

8.8 Mechanical Shock: EIA-364-27

Five connectors shall be monitor for event detection > 1 microsecond.

- a) Type: 30g, 11 ms pulse duration, ½ Sine
- b) Direction: In each of three mutually perpendicular planes
- c) Number: 3 shocks per axis (18 total shocks)
- d) After completion of test in all three axis, connector shall meet post environmental LLCR requirement.

NUMBER GS-12-192	TYPE PRODUCT SPECIFICATION		
TITLE GIG-ARRAY® High Speed Mezzanine Connectors 15-35 mm Board to Board		PAGE 12 of 15	REVISION G
		AUTHORIZED BY D. Harper	DATE 20 OCT 07
		CLASSIFICATION UNRESTRICTED	

8.9 Dust: EIA-364-91

Where specified in test sequence, connectors shall have dust applied to unmated interfaces.

- a) Use dust composition #1 Benign
- b) Use 9 g dust / each ft³ of test chamber space
- c) Dry dust for 1 hour at 50°C prior to application to connector.
- d) Connector shall have dust exposure for 1 hour at 300 cfm flow rate.
- e) After exposure, let connectors sit for 1 hour in chamber.

8.10 Disturbed Interface:

After exposure to MFG and post LLCR measurement, connector interface shall be disturbed so that contact surfaces move about 0.10mm (.004 inches) or less.

9.0 **QUALITY ASSURANCE PROVISIONS**

9.1 Equipment Calibration

All test equipment and inspection facilities used in the performance of any test shall be maintained in a calibration system in accordance with ANSI/NCSL Z-540-1

9.2 Inspection Conditions

Unless otherwise specified herein, all inspections shall be performed under the following ambient Conditions:

- a) Temperature: 25 ± 5° C.
- b) Relative Humidity: 30% to 60%
- c) Barometric pressure: Local ambient

9.3 Sample Quantity And Description

Refer to Table 1 for sample quantity.

Test group 1 requires connector pairs terminated to LLCR PCB.

Test group 2 requires five connector pairs terminated to LLCR PCB and a minimum of three connector pairs terminated to continuity PCB.

Test group 3 requires loose piece connector pairs.

Test group 4 requires five connector pairs terminated to LLCR PCB and a minimum of three connector pairs terminated to continuity PCB. Mated connectors shall be held together with standoffs and fasteners.

Test group 5 requires connector pairs terminated to 0.062" minimum thickness LLCR PCB.

Test group 6 requires loose piece connectors.

Test group 7 requires connectors terminated to continuity PCB. Mated connectors shall be held together with standoffs and fasteners.

Test group 8 requires connector pairs terminated to 0.062" nominal thickness PCB.

Test group 9 requires connector pairs terminated to special serial current test PCB.

Test group 10 requires connector pairs terminated to special high-speed test PCB.

NUMBER GS-12-192	TYPE PRODUCT SPECIFICATION		
TITLE GIG-ARRAY® High Speed Mezzanine Connectors 15-35 mm Board to Board		PAGE 13 of 15	REVISION G
		AUTHORIZED BY D. Harper	DATE 20 OCT 07
		CLASSIFICATION UNRESTRICTED	

9.4 Acceptance

- 9.4.1 Electrical and mechanical requirements placed on test samples as indicated in paragraphs 6.0 and 7.0 shall be established from test data using appropriate statistical techniques or shall otherwise be customer specified, and all samples tested in accordance with this product specification shall meet the stated requirements.
- 9.4.2 Failures attributed to equipment, test set-up or operator error shall not disqualify the product. For failures attributed to the product, corrective action shall be taken and samples resubmitted for qualification.

9.5 Qualification Testing

Qualification testing shall be performed on sample connectors produced with equipment and procedures normally used in production. The test sequence shall be as shown in Table 1.

9.6 Requalification Testing

If either of the following conditions occur, the responsible Product Engineer shall initiate requalification testing consisting of all applicable parts of qualification test matrix, Table 1.

- (a) A significant design change is made to existing product, which impacts product form, fit or function. Examples include, but shall not be limited to, changes in plating material, composition or thickness, contact force, base material or interface geometry, housing material or design or solder composition.
- (b) A significant change is made to the product manufacturing process, which impacts the product form, fit or function.
- (c) A significant event occurs during production or end use requiring corrective action to be taken relative to the product design or manufacturing process.

NUMBER GS-12-192	TYPE PRODUCT SPECIFICATION		
TITLE GIG-ARRAY® High Speed Mezzanine Connectors 15-35 mm Board to Board		PAGE 14 of 15	REVISION G
		AUTHORIZED BY D. Harper	DATE 20 OCT 07
		CLASSIFICATION UNRESTRICTED	

TEST	PARA.	TEST GROUP									
		1	2	3 ³	4	5	6 ⁴	7	8	9	10
		TEST SEQUENCE									
Examination of Product	5.4	1,17	1,13	1,8	1,13	1,7	1,5	1,3	1,3	1,3	1
Contact Resistance Low Level	6.1	2 ⁶ ,4,6,8,10, 12,14,16 ⁷	2 ⁶ ,4,6,8,10, 12 ⁷		2 ⁶ ,4,6,8,10, 12 ⁷	3,5					
Insulation Resistance	6.2			2,6							
Dielectric Withstanding Voltage	6.3			3,7							
Current Rating	6.4									2	
Propagation Delay	6.6										2
Characteristic Impedance	6.7										3
Crosstalk	6.8										4
Diff Eye Pattern	6.10										5
Mating/Unmating Force	7.1					2,6					
Contact Normal Force	7.3						2,4				
Mechanical Vibration	8.7				7						
Mechanical Shock	8.8				9						
3-point Bend	7.2								2		
Temperature Cycling	8.1							2			
Thermal Shock	8.4		3	4							
Temperature-Humidity	8.2		9	5							
Hi Temperature Life	8.3					4	3				
Durability	8.6	3 ^{1,6} ,15 ^{2,7}	5 ^{1,6} ,11 ^{2,7}		3 ^{1,6} ,11 ^{2,7}						
Corrosive Atmosphere	8.5	5 ^{8,9} ,7 ^{8,9} ,9 ⁹ , 11 ⁹									
Dust	8.9		7		5						
Disturbed Interface	8.10	13									
Qty. Conn Pair/Group		10	8	2	10	5	3 ⁴	30	3	2	1

Notes:

1. First 50% of the total number of specified durability cycles.
2. Second 50% of the total number of specified durability cycles.
3. Except for during IR and DWV measurements, connector pairs are unmated.
4. Only receptacle connectors are to be tested in this group. Mate with standard plug, or to simulate mated condition, mate with 0.20±. 0.013 mm thick copper plate during Hi Temp. Life.
5. Prior to application of dust, precondition connectors with first 50% of the total number of specified durability cycles.
6. Record LLCR after first mate.
7. Record LLCR prior to last unmate.
8. For initial 10 days, connectors are unmated in MFG chamber.
9. Expose in 5-day increments.

TABLE 1 – QUALIFICATION TESTING SEQUENCE

NUMBER GS-12-192	TYPE PRODUCT SPECIFICATION		
TITLE GIG-ARRAY® High Speed Mezzanine Connectors 15-35 mm Board to Board		PAGE 15 of 15	REVISION G
		AUTHORIZED BY D. Harper	DATE 20 OCT 07
		CLASSIFICATION UNRESTRICTED	

REVISION RECORD

REV	PAGE	DESCRIPTION	EC #	DATE
A	All	Initial Release	V21483	9/10/2002
B		Added additional "new" 200 position size and new heights Changed 200 Pos. withdraw force from 4.8 kgms to 4.0 kgms on page 7. Also changed the Qualification table on page 14 to reflect the actual testing of the qualification test. Revision B had the	V03-0917	9/29/2003
C	7&14	incorrect table attached.	V04-0284	3/24/2004
D	2&3	Add part numbers; 10055143 and 10055142 Lead Free additions and 25mm Plug information added	V05-1058	11/17/05
E		Diff Eye Pattern replaced Rise time testing, document error	V06-0083	2/10/06
F	All	Change logo	V06-0539	6/5/2006
G	8	Changed 7.1 Max. mating forces to Average and Min un-mating.		
	5	Changed 6.4 to add 3 contact power rating		
	1-2	Updated 4.1 drawing numbers	V07-0618	10/20/2007