

AV series

Anti-vandal and security pushbutton switches

Distinctive features

- ❑ **Attractive, robust and durable**
 - Irremovable
 - Anti-jamming construction : reduced travel to prevent insertion of foreign parts
 - Contact and mechanism protected against crushing
 - Fire resistant
 - Long life
- ❑ **Different actuator shapes**
- ❑ **Sealed versions**
- ❑ **Degree of protection of sealed versions**
(switches mounted on vertical panels) : IP65 to IP67
- ❑ **UL/CSA approved models**

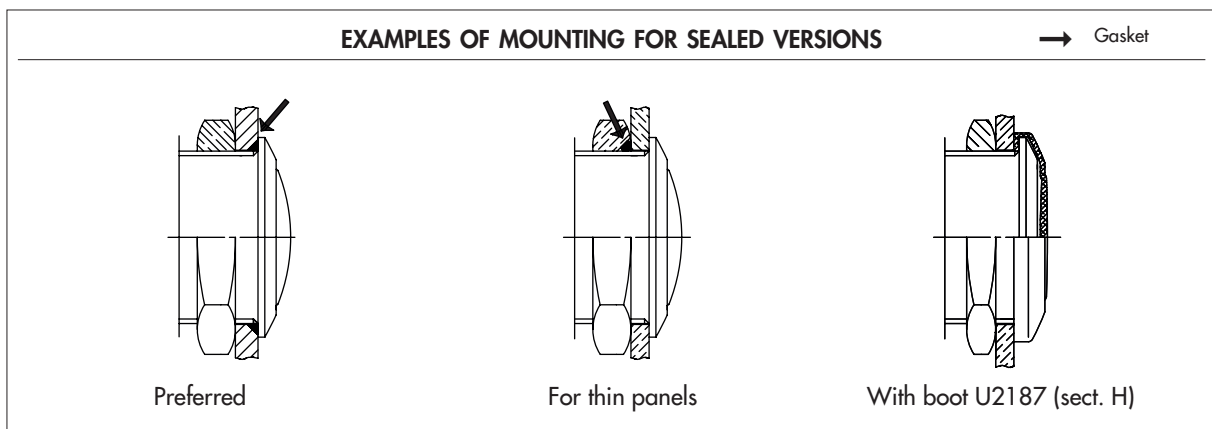
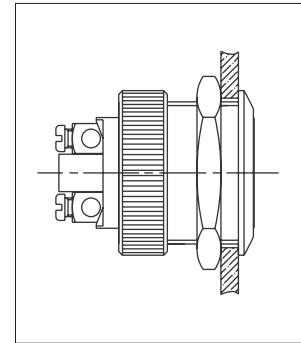

Packaging unit : specified on the following pages.



Mounting accessories : Standard and special hardware are presented in section I.



Sealing boots are available for models with \varnothing 19 mm (.748) bushing. See Section H.

The AV series is a large range of very robust pushbutton switches, consisting of 2 families :

ANTI-VANDAL PUSHBUTTON SWITCHES (pages B-92 to B-94)

- Great robustness (impact resistance IK08 (Ø 19 mm) and IK10 (Ø 22 mm))
- Actuator and bushing : stainless steel
- Bushing Ø 19 mm (.748) or 22 mm (.866)

Actuator	Bushing Ø 19 mm (.748)			Bushing Ø 22 mm (.866)			
	flat	curved	flush	flat		curved	
Flat on bushing	no	no	no	no	yes	no	yes
48VDC	AV09100	AV19100	AV9D100	AV03100	AVM3100	AV02100	AVM2100
250VAC	AV09000	AV19000	AV9D000	AV03000	AVM3000	AV02000	AVM2000

SECURITY PUSHBUTTON SWITCHES (pages B-95 to B-115)

- Large variety of models
- Actuator and bushing : nickel plated, chrome plated or polished varnished brass, stainless steel
- Bushing diameter 16 mm (.629), 19 mm (.748), 22 mm (.866) or 24 mm (.944)
- Marking
- Illumination, tactile feedback
- Numerous electrical functions (momentary or maintained)

Actuator	Bushing Ø 16 mm (.629)				Page
	flat		curved		
Mounting nut	hex	knurled	hex	knurled	
Momentary (NO) tactile	AV063	AV6P3	AV163	AV6B3	B-95
Latching (on-off)	AV061	-	AV161	-	B-96

Actuator	Bushing Ø 19 mm (.748)				Page
	flat		curved		
Mounting nut	hex	knurled	hex	knurled	
Momentary (NO)	AV09•003	AV9P•003	AV19•003	AV9B•003	B-98
Momentary NC/NO	AV19LP	-	-	-	B-101
Latching (on-on)	AV091••EA		AV191••EA	-	B-102
Momentary NO tactile	AV09C7•3	-	AV19C7•3	-	B-104
Momentary NO tactile overmolded actuator	AV9S•D		-	-	B-106

Actuator	Bushing Ø 22 mm (.866)					Page
	flat		curved		concave	
Mounting nut	hex	knurled	hex	knurled	hex	
Momentary (NO)	AV03•003	-	AV02•003	-	-	B-108
Momentary (NC)	AV031202	-	AV021202	-	-	B-109
Latching (on-on)	AV031••EA	-	AV021••EA	-	-	B-111
Mom. NC/NO, Ø 26 actuator	AV22LP	-	AV22LB	-	AV22LC	B-113
Mom. NC/NO, Ø 30 actuator	-	-	AV22PNA*	-	-	B-115

Actuator	Bushing Ø 24 mm (.944)			Page
	flat	curved	concave	
Momentary (NO)	AV24LP	AV24LB	AV24LC	B-114

Please contact APEM for any product not mentioned in the above tables.

AV series

Anti-vandal pushbutton switches

Distinctive features and specifications

- Very robust**
Impact resistance IK08 for model Ø 19 mm (.748)
and IK10 for model Ø 22 mm (.866)
- Stainless steel actuator and bushing**
- UL-CSA approved (long case only)**

SPECIFICATIONS

- Max. current/voltage rating with resistive load :
 - A contacts : 4A 12VDC, 500.000 cycles
 - C contacts : 2A 48 VDC, 10.000 cycles
- Approved ratings of models with long case and A contacts (AV..000) :
UL-CSA : 4A 250VAC - 8A 125VAC - 6.000 cycles
- Initial contact resistance : 10 mΩ max. at 1A 2V
- Insulation resistance : 1.000 MΩ min. at 500VDC
- Dielectric strength : 2.000 Vrms 50 Hz min. between terminals and frame
2.000 Vrms 50 Hz min. between terminals
- Torque : 5 Nm min.- 14 Nm max. applied to nut
- Panel thickness : 1 (.039) to 11 mm (.433) max.
- Operating temperature : -30°C to +70°C
- Mechanical life : 1.000.000 cycles
- Hand soldering : 300°C, 3 sec. max.
- Packaging unit : 20 pieces (models Ø 22) or 40 pieces (models Ø 19)

MATERIALS

- Case : PBT
- Contacts : silver (A)
or brass, silver plated (C)
- Bushing : stainless steel
- Actuator : stainless steel

CUT-OUT

- Panel cut-out :
Ø 19,2 mm (.755)
or Ø 22,2 mm (.874)
- Min. pitch for matrix mounting :
30 mm x 30 mm (1.181x1.181)

ROBUSTNESS

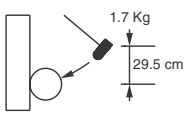
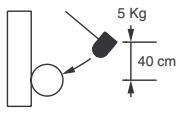
	Model Ø 19 mm (.748)		Model Ø 22 mm (.866)	
Degree of protection according to EN 50102, June 95 (NFC 20-015)		IK08 Striking energy: 5 joules (5Nm)		IK10 Striking energy: 20 joules (20Nm)
	Hammer radius 25 mm		Hammer radius 50 mm	

Increased impact resistance provided by a nut or mechanical stop.

SEALING (OPTION T)

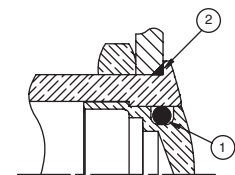

Front panel sealing (IP65)

① internal gasket ② external gasket

Option N does not include ① nor ②.

AV series

Anti-vandal pushbutton switches Ø 19 mm (.748)

Momentary (NO)

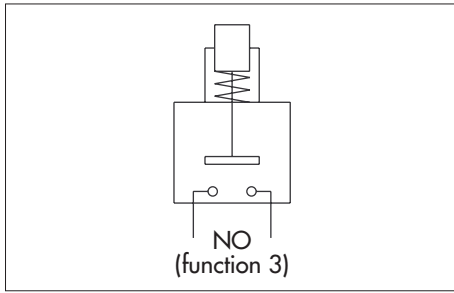

ORDER FORMAT

AV			3			40	
SERIES	Actuator type	Case	Function	Contacts	Terminals	Bush./act. material	Sealing
	09 Flat 19 Curved 9D Flush	000 Long 100 Short	3 NO	A Silver C Brass, silver pl.	9 Screw 2 Quick-connect	40 Stainless steel	N No Sealed T Sealed

In the following model numbers, replace • with elements selected in the above order format.

Flat actuator - short case - 48VDC - AV09100

Hex nut 22 (.866) across flats



Screw terminals
AV091003•940•



Solder lug / quick-connect term.
AV091003•240•



Screw terminals for wires 1,5 mm² max.

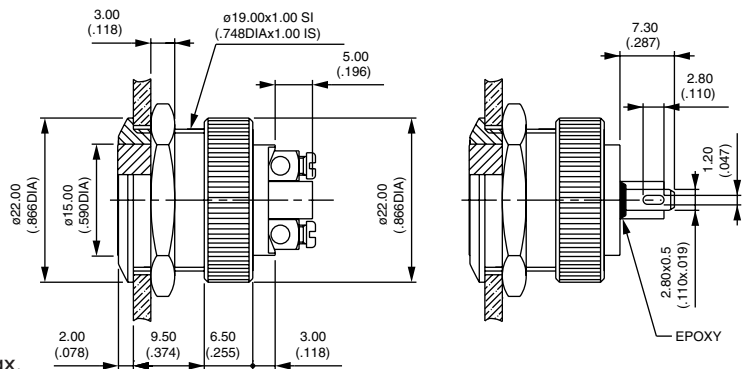

Flat actuator - long case - 250VAC - UL/CSA - AV09000

Hex nut 22 (.866) across flats



Screw terminals
AV090003A940•



To order switches **marked UL-CSA**, add "UU" at the end of model number.

Screw terminals for wires 1,5 mm² max.

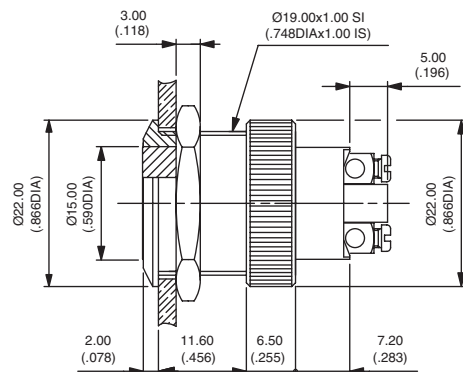

Curved actuator - AV19

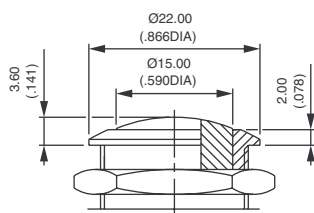

Screw terminals
AV19•003•940•

Solder lug/quick-connect term. (short case)
AV191003•240•

Flush model - AV9D

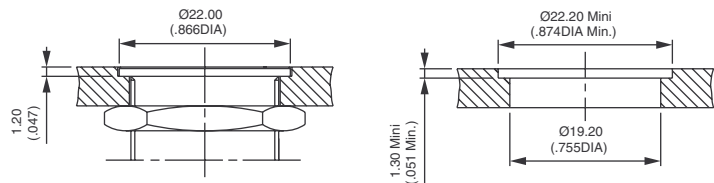

Screw terminals
AV9D•003•940•

Solder lug / quick-connect terminals (short case only)
AV9D1003•240•

AV series

Anti-vandal pushbutton switches \varnothing 22 mm (.866)

Momentary (NO)

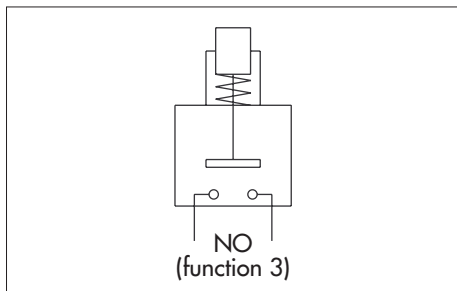

ORDER FORMAT

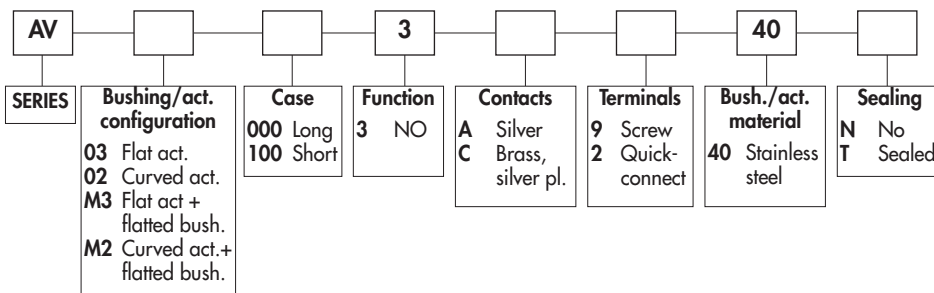

B

In the following model numbers, replace • with elements selected in the above order format.

Flat actuator - short case - 48VDC - AV03100

Hex nut 25 (.984) across flats



Screw terminals
AV031003•940•



Solder lug / quick-connect term.
AV031003•240•



Screw terminals for wires 1,5 mm² max.

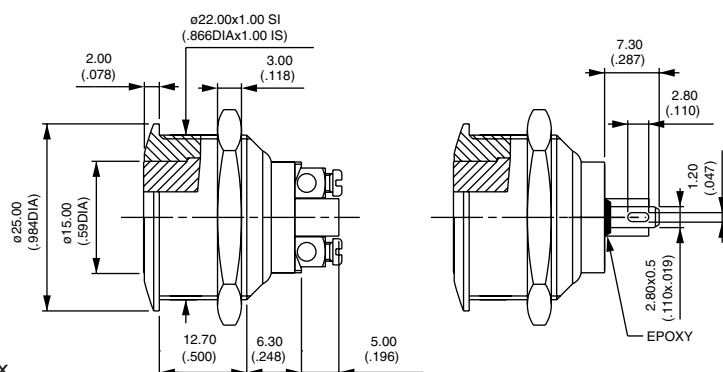

Flat actuator - long case - 250 VAC - UL/CSA - AV03000

Hex nut 25 (.984) across flats



Screw terminals
AV030003A940•



To order switches **marked UL-CSA**, add "UU" at the end of model number.

Screw terminals for wires 1,5 mm² max.

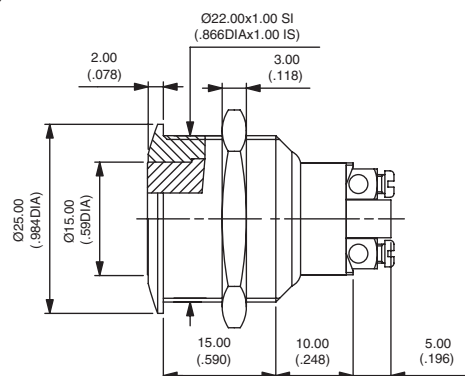

Curved actuator - AV02

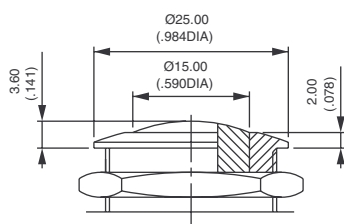

Screw terminals
AV02•003•940•
Solder lug / quick-connect (short case)
AV021003•240•

Flatted bushing - AVM3 and AVM2

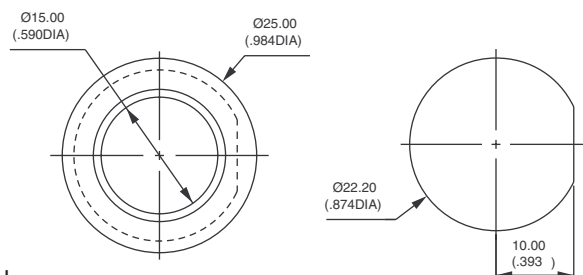

Flat actuator, screw terminals
AVM3•003•940•

Curved actuator, screw terminals
AVM2•003•940•

Panel cut-out



AV series

Snap action security pushbutton switches Ø 16 mm (.629)

Momentary (NO)

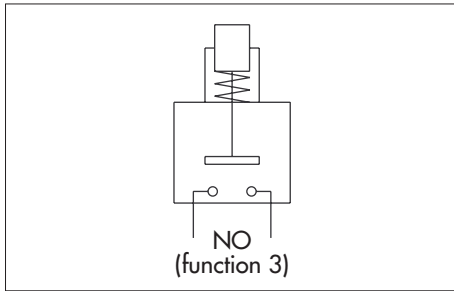

ORDER FORMAT

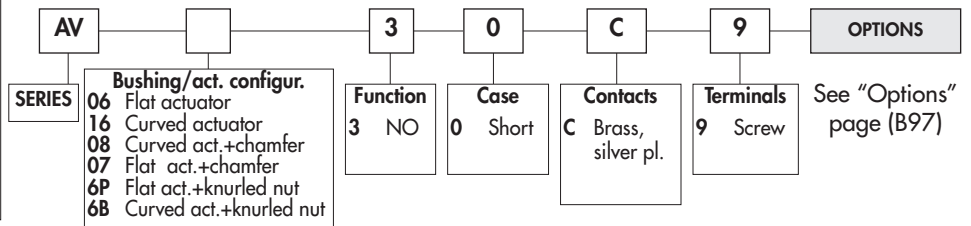

SPECIFICATIONS

- **Travel : 1,60 mm (.063) ± 0,3 mm (.011)**
- **Max. current/voltage rating with resistive load :**
200mA 48 VDC - 100mA 48VDC
- **Initial contact resistance : 50 mΩ max.**
- **Insulation resistance : 1.000 MΩ min. at 500VDC**
- **Dielectric strength : 2.000 Vrms 50 Hz min. between terminals and frame**
- **Electrical life : 50.000 cycles at 200mA 48VDC**
100.000 cycles at 100mA 48VDC
- **Torque : 5 Nm min.- 14 Nm max. applied to nut**
- **Panel thickness : 1 (.039) to 6 mm (.236) max.**
- **Operating temperature : -30°C to +70°C**
- **Mechanical life : 1.000.000 cycles**
- **Packaging unit : 60 pieces**

MATERIALS

- **Case : PBT**
- **Contacts : brass, silver plated (C)**
- **Bushing and actuator : see "Options" page**

CUT-OUT

- **Panel cut-out : Ø 16,2 mm (.637)**
- **Min. pitch for matrix mounting : 24 mm x 24 mm (.944 x .944)**
(AV6P & AV6B : 20 mm x 20 mm)

To order a product, select a basic model below and add the desired options.

BASIC MODEL

Flat or curved actuator - screw terminals

Hex nut 19 (.748) across flats



Flat actuator
AV0630C9

Curved actuator
AV1630C9

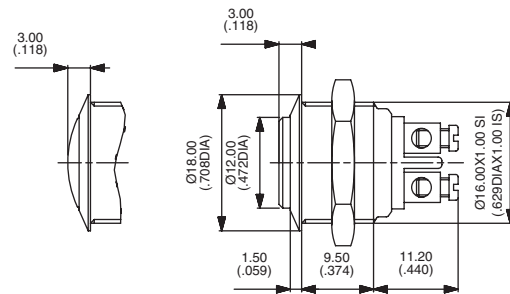
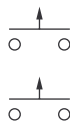

Screw terminals for wires 1,5 mm² max.

With chamfer

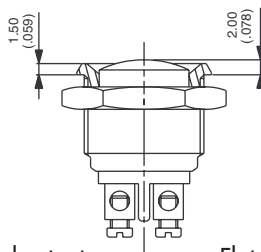

Curved actuator
AV0830C9

Flat actuator
AV0730C9

With knurled nut for matrix mounting 20 x 20 - AV6P and AV6B

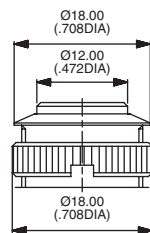

Flat actuator
AV6P30C9

New!

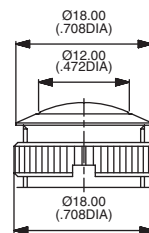

Curved actuator
AV6B30C9

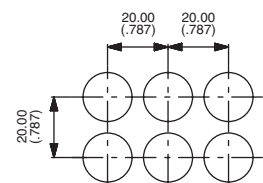

Wrench available under P/N U1990.

AV series

Security pushbutton switches Ø 16 mm (.629)



Latching action

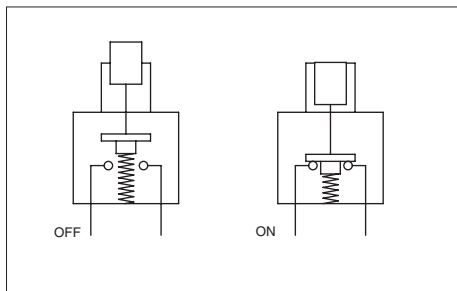

ORDER FORMAT

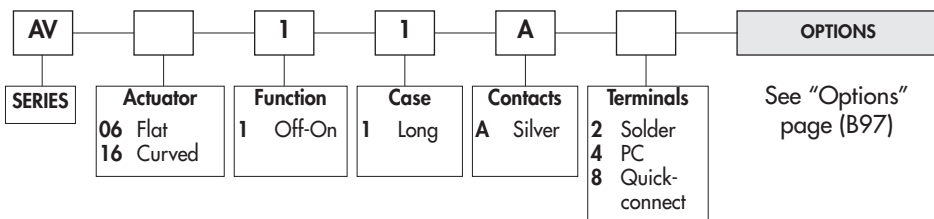

SPECIFICATIONS

- Max. current/voltage rating with resistive load : 1,5A 250VAC - 1A 24VDC
- Initial contact resistance : 50mΩ max.
- Insulation resistance : 1 GΩ min. at 500VDC
- Dielectric strength : 1.500 Vrms 50 Hz min. between terminals
1 000 Vrms 50 Hz between terminals and frame
- Electrical life : 100.000 cycles at 1,5A 250VAC
40.000 cycles at 1A 24VDC
- Torque : 5 Nm min. - 14 Nm max. applied to nut
- Panel thickness : 1 (.039) to 6 mm (.236) max.
- Operating temperature : -30°C to +70°C
- Mechanical life : 200.000 cycles
- Hand soldering : 300°C, 5 sec. max.
- Packaging unit : 25 pieces

MATERIALS

- Case : PA-6T, UL94-V0
- Contacts : silver (A)
Gold plated silver (AD) on request
- Bushing and actuator : see "Options" page

CUT-OUT

- Panel cut-out : Ø 16,2 mm (.637)
- Min. pitch for matrix mounting : 24 mm x 24 mm (.944 x .944)

To order a product, select a basic model below and add the desired options.

BASIC MODEL

Flat or curved actuator - solder lug terminals

Hex nut 19 (.748) across flats



Flat actuator
AV0611A2 OFF - ON

Curved actuator
AV1611A2 OFF - ON

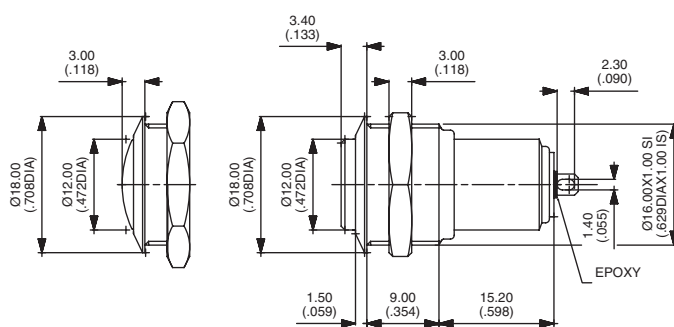

Straight PC terminals

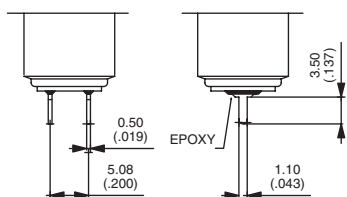

Flat actuator
AV0611A4

Curved actuator
AV1611A4

Quick-connect terminals

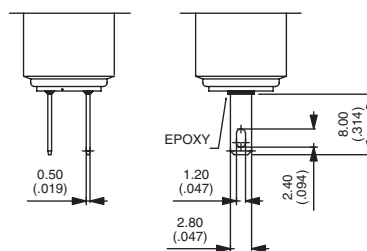

Flat actuator
AV0611A8

Curved actuator
AV1611A8



AV series

Security pushbutton switches Ø 16 mm (.629)

Options

After selecting basic model number,
fill in last 2 boxes
with desired options.

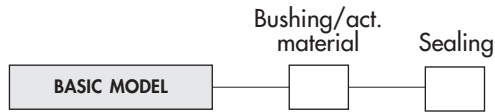

BUSHING/ACTUATOR MATERIALS

Flat or curved metal actuator

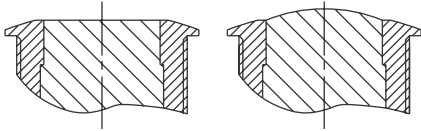

CODE	BUSHING	ACTUATOR
00 (standard)	Nickel plated brass	Nickel plated brass
10	Nickel plated brass	Stainless steel
12	Nickel plated brass	Chrome plated brass
20	Chrome plated brass	Chrome plated brass
30	Chrome plated brass	Stainless steel
40	Stainless steel	Stainless steel

SEALING

Blank	No sealing
K	Front panel sealing (IP65)

AV series

Security pushbutton switches Ø 19 mm (.748)

Momentary (NO)

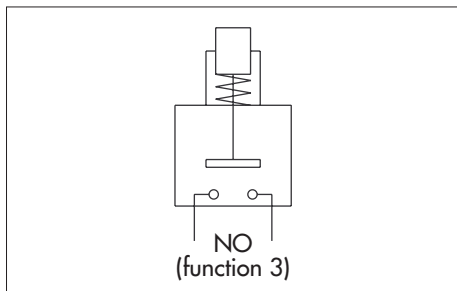

ORDER FORMAT

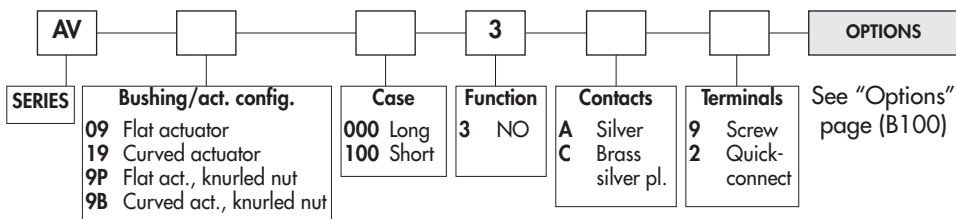

SPECIFICATIONS

- Max. current/voltage rating with resistive load :
 - A contacts : 4A 12VDC, 500.000 cycles
 - C contacts : 2A 48 VDC, 10.000 cycles
- Approved ratings of models with long case and A contacts (AV..000) :
 - UL-CSA : 4A 250VAC - 8A 125VAC - 6.000 cycles
- Initial contact resistance : 10 mΩ max. at 1A 2V
- Insulation resistance : 1.000 MΩ min. at 500VDC
- Dielectric strength : 2.000 Vrms 50 Hz min. between terminals and frame
2.000 Vrms 50 Hz min. between terminals
- Torque : 5 Nm min.- 14 Nm max. applied to nut
- Panel thickness : 1 (.039) to 11 mm (.433) max.
- Operating temperature : -30°C to +70°C
- Mechanical life : 1.000.000 cycles
- Hand soldering : 300°C, 3 sec. max.
- Packaging unit : 40 pieces

MATERIALS

- Case : PBT
- Contacts : silver (A) or brass, silver plated (C)
- Bushing and actuator : see "Options" page

CUT-OUT

- Panel cut-out : Ø 19,2 mm (.755)
- Min. pitch for matrix mounting : 30 mm x 30 mm (1.181x1.181) (AV9P & AV9B : 25 mm x 25 mm)

To order a product, select a basic model below and add the desired options.

BASIC MODEL

Flat actuator - short case - 48VDC - AV09100

Hex nut 22 (.866) across flats



Screw terminals
AV091003•9

Solder lug / quick-connect term.
AV091003•2



Screw terminals for wires 1,5 mm² max.

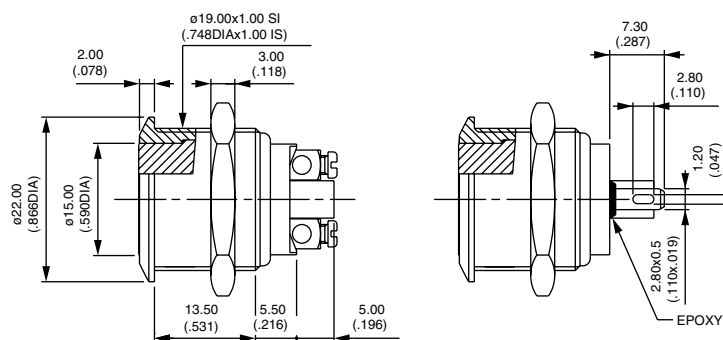

Contacts : replace • with A (silver) or C (silver plated brass).

Curved actuator - short case

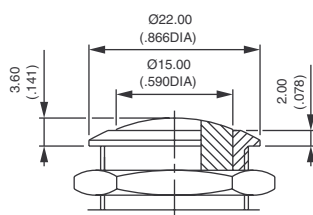

Screw terminals
AV191003•9

Solder lug / quick-connect terminals
AV191003•2

With knurled nut for matrix mounting 25 x 25 - AV9P and AV9B

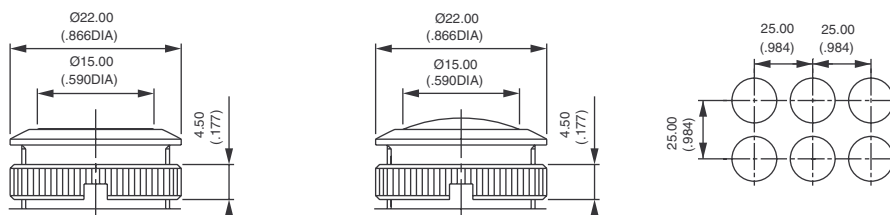

Flat actuator, screw terminals
AV9P1003•9

Flat actuator, solder lug term.
AV9P1003•2

Curved actuator, screw terminals
AV9B1003•9

Curved actuator, solder lug term.
AV9B1003•2

Wrench available under P/N U1929



AV series

Security pushbutton switches Ø 19 mm (.748)

Momentary (NO)

Flat actuator - long case - 250VAC - UL/CSA - AV09000

Hex nut 22 (.866) across flats



Screw terminals
AV090003A9



To order switches marked **UL-CSA**, add "UU" at the end of model number.

Screw terminals for wires 1,5 mm² max.

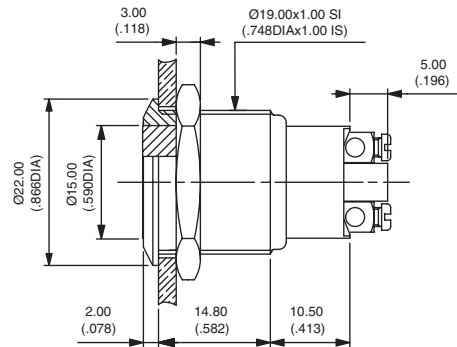

Curved actuator - long case

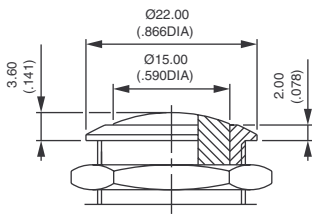

Screw terminals
AV190003A9

With knurled nut for matrix mounting 25 x 25 - AV9P and AV9B

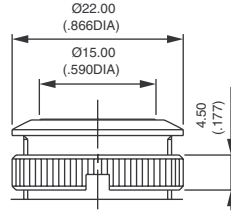

Flat actuator, screw terminals
AV9P0003A9

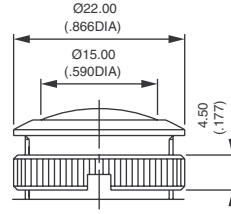

Curved actuator, screw terminals
AV9B0003A9

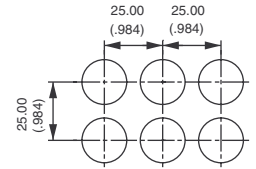

Wrench available under P/N **U1929**.

AV series

Security pushbutton switches Ø 19 mm (.748)

OPTIONS
● ● ●

Options

After selecting basic model number, fill in last 3 boxes with desired options.

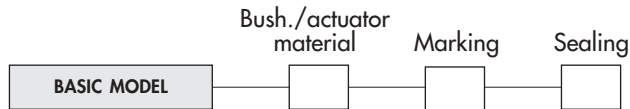

BUSHING/ACTUATOR MATERIALS

Flat or curved metal actuator

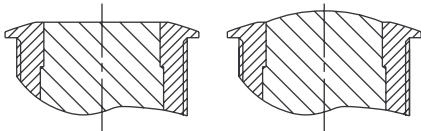

CODE	BUSHING	ACTUATOR
00 (standard)	Nickel plated brass	Nickel plated brass
10	Nickel plated brass	Stainless steel
12	Nickel plated brass	Chrome plated brass
20	Chrome plated brass	Chrome plated brass
30	Chrome plated brass	Stainless steel
40	Stainless steel	Stainless steel
80	Varnished polished brass	Varnished polished brass

Flat thermoplastic actuator

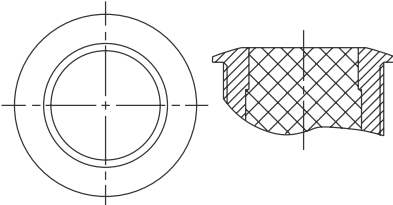

CODE	BUSHING	ACTUATOR COLOUR
0• (standard)	Nickel plated brass	Replace • with one of the following codes.
2•	Chrome plated brass	1 : blue - 1/4 : dark blue - 2 : black - 3 : green
8•	Varnished polished brass	4 : grey - 5 : yellow - 6 : red - 7/1 : white
		9 : orange

MARKING

- By engraving on flat or curved brass actuator (stainless steel on request)
- by hot stamping on flat thermoplastic actuator

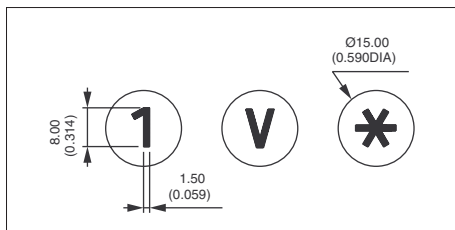

Select an option from each of the two tables below.

TYPE OF MARKING

CODE	TYPE
0 to 9	Numbers 0 to 9
X	Symbol *
Y	Symbol #
A to N	Letters A to N
P to W	Letters P to W
0	Letter O

Letter O : same code and same design as number 0.

For special symbols, consult factory.
Minimum order : 500 pieces

COLOUR OF MARKING

CODE	COLOUR
Brass actuator	
0 (standard)	Same as finish
2	Black

Note : a finished product supplied in version "0" cannot be modified to version "2".

CODE	COLOUR
Thermoplastic actuator	
2	Black
7	White

SEALING

Blank No sealing

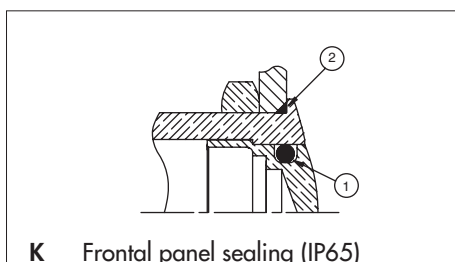

K Frontal panel sealing (IP65)

- ① internal gasket
- ② external gasket

AV series

New!

Security pushbutton switches Ø 19 mm (.748)

Momentary (NC/NO)

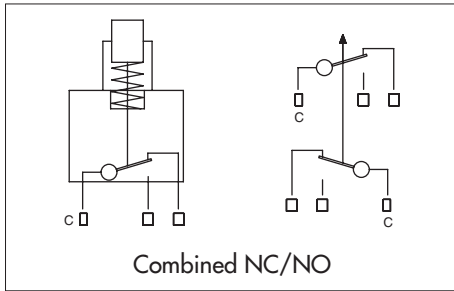

ORDER FORMAT

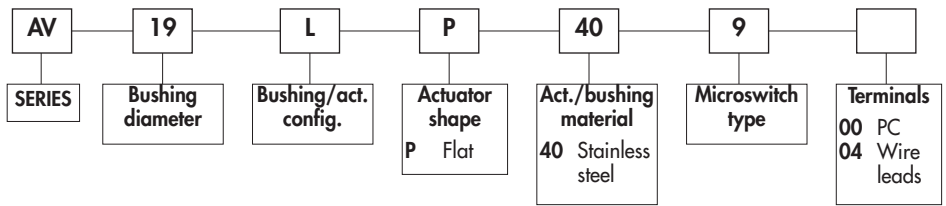

SPECIFICATIONS

- Max. current/voltage rating with resistive load :
2A 12VDC, 200.000 cycles - 1A 24VDC, 200.000 cycles
3A 125Vca - 0,2A 60VDC - 6.000 cycles
- Initial contact resistance : 100 mΩ max.
- Insulation resistance: 100 MΩ min. at 500VDC
- Dielectric strength : 500 Vrms 50 Hz min.
- Torque : 5 Nm min.- 14 Nm max. applied to nut
- Panel thickness : 1 (.039) to 6 mm (.236) max.
- Operating temperature : -20°C to +55°C
- Mechanical life : 1.000.000 cycles
- Front panel sealing : IP65
- Hand soldering : 300°C, 3 seconds max.
- Packaging unit : models with straight PC terminals : 20 pieces
Models with wire lead terminals : individual bags

MATERIALS

- Contacts : silver
- Bushing and actuator : stainless steel

CUT-OUT

- Panel cut-out : Ø 19,2 mm (.755)
- Min. pitch for matrix mounting : 30 mm x 30 mm (1.181x1.181)

BASIC MODEL

The common terminal is indicated by the letter C on the drawing.

Flat actuator - straight PC terminals

→ O-Ring

Hex nut 22 (.866) across flats



AV19LP40900

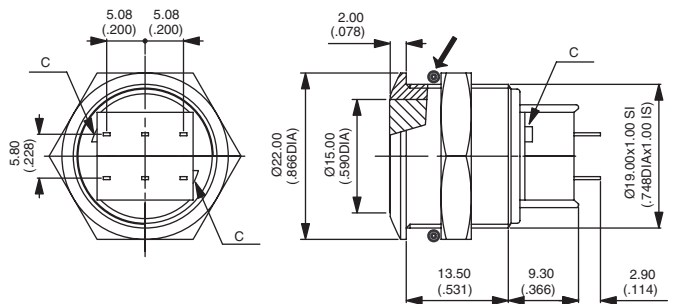

Flat actuator - wire lead terminals

→ O-Ring

Hex nut 22 (.866) across flats



AV19LP40904

Wire length : 500 mm

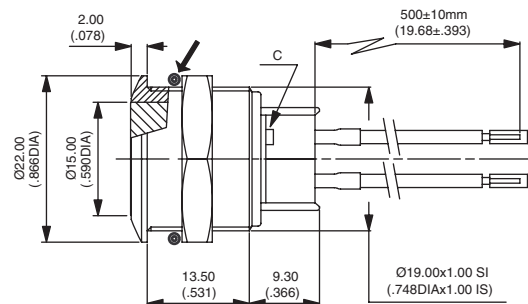

In the upper position (ON), the closed circuit is through the red wires.
In the lower position (MOM), the closed circuit is through the blue wires.

AV series

Security pushbutton switches Ø 19 mm (.748)

New!

Latching - illuminated and non-illuminated

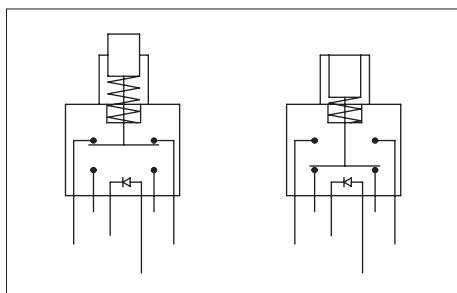

ORDER FORMAT

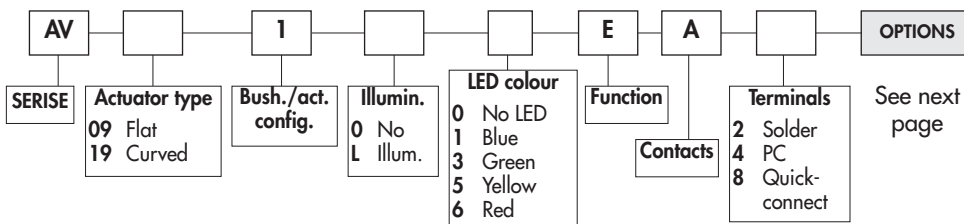

SPECIFICATIONS

- Max. current/voltage rating with resistive load : 2A 48 VDC
 - LED voltage and consumption : blue 3,5V 10mA, green : 2V 10mA yellow & red : 2V 20mA (a resistor must be series-connected by the user)**
 - Initial contact resistance : 50 mΩ max.
 - Insulation resistance : 1.000 MΩ min. at 500VDC
 - Dielectric strength : 1 000 Vrms 50 Hz min. between terminals 500 Vrms 50 Hz min. between terminals and bushing
 - Electrical life : 500.000 cycles at 2A 48VDC
 - Torque : 5 Nm min.- 14 Nm max. applied to nut
 - Panel thickness : 1 (.039) to 9 mm (.354) max.
 - Operating temperature : -30°C to +70°C
 - Mechanical life : 1.000.000 cycles
 - Hand soldering : 300°C, 4 seconds max.
 - Packaging unit : 20 pieces
- ** Resistor value = $\frac{\text{supply voltage} - \text{LED forward voltage}}{\text{LED forward current}}$

MATERIALS

- Case : PA6T UL94-V0
- Contacts : silver
- Bushing and actuator : see next page
- LED

CUT-OUT

- Panel cut-out : Ø 19,2 mm (.755)
- Min. pitch for matrix mounting : 30 mm x 30 mm (1.181 x 1.181)

To order a product, select a basic model below and add the desired options selected on next page.

Standard actuator position : the actuator is flush in the non-latched position and recessed in the latched position.

Non-illuminated - solder lug terminals

Hex nut 22 (.866) across flats



Flat actuator *
AV09100EA2 ON - ON

Curved actuator
AV19100EA2 ON - ON

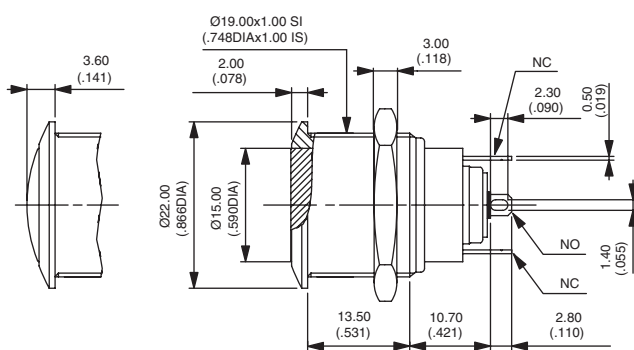

* Also available with prominent actuator in the non-latched position

Illuminated - solder lug terminals

Hex nut 22 (.866) across flats



Flat actuator
AV091L•EA2 ON - ON

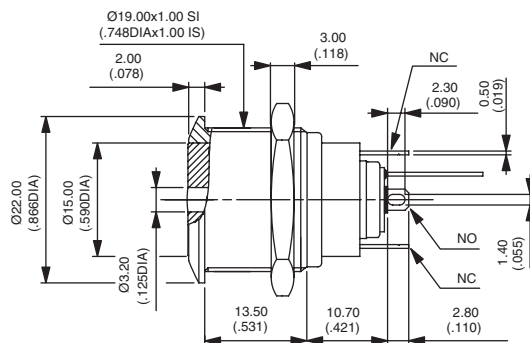

Replace • with desired LED colour.

New!

Security pushbutton switches \varnothing 19 mm (.748)

Latching - Options

Straight PC terminals

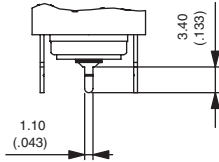

Replace 2 with 4 at the end of the model numbers shown on previous page.

Quick-connect terminals

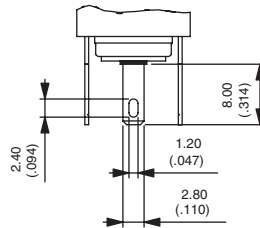

Replace 2 with 8 at the end of the model numbers shown on previous page.

After selecting basic model number, fill in last 2 boxes with desired options.

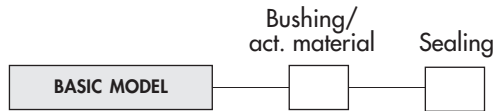

BUSHING/ACTUATOR MATERIALS

CODE	BUSHING	ACTUATOR
00 (std)	Nickel plated brass	Nickel plated brass
10	Nickel plated brass	Stainless steel
40	Stainless steel	Stainless steel
50	Stainless steel	Nickel plated brass

SEALING

Blank No sealing

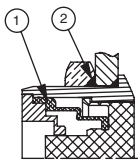

K Frontal panel sealing (IP65)

- ① elastomeric membrane
- ② external gasket

AV series

Snap-action security pushbutton switches Ø 19 mm (.748)

Illuminated and non-illuminated - momentary (NO)

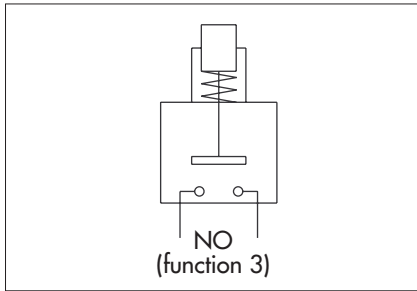

ORDER FORMAT

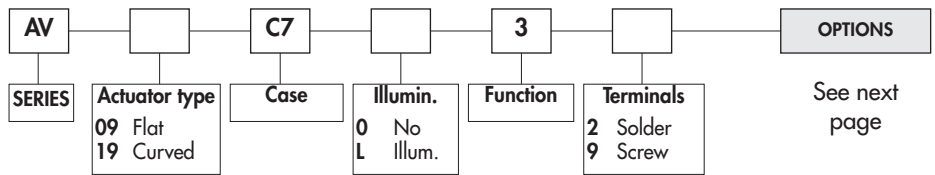

SPECIFICATIONS

- Travel : 0,7 mm (.027) ±0,1 mm (.003)
- Max. current/voltage rating with resistive load : 50mA 24VDC
- LED voltage and consumption : 2-colour LED : 2V (3V max.) 20mA
Other colours : 2V (3V max.) 10mA
A resistor must be series-connected by the user **
- Initial contact resistance : 100 mΩ max.
- Insulation resistance : 1.000 MΩ min. at 500VDC
- Dielectric strength : 500 Vrms 50 Hz min. between terminals
2.000 Vrms 50 Hz min. between terminals and bushing
- Electrical life : 1.000.000 cycles at full load
- Operating force : 7 N ±2N
- Torque : 5 Nm min.- 14 Nm max. applied to nut
- Panel thickness : 1 (.039) to 6 mm (.236) max.
- Operating temperature : -30°C to +70°C
- Hand soldering : 270°C, 3 seconds max.
- Packaging unit : 40 pieces

** Resistor value = $\frac{\text{supply voltage} - \text{LED forward voltage}}{\text{LED forward current}}$

MATERIALS

- Case : PBT UL94-V0
- Terminals : brass, gold plated
- Contacts : gold plated dome
- Bushing and actuator : see next page
- LED

CUT-OUT

- Panel cut-out : Ø 19,2 mm (.755)
- Min. pitch for matrix mounting : 30 mm x 30 mm (1.181x1.181)

To order a product, select a basic model below and add the desired options selected on next page.

Flat actuator - non-illuminated

Hex nut 22 (.866) across flats



Solder lug terminals
AV09C703D2



Screw terminals
AV09C703D9



Also available with curved actuator :
AV19C703D2 or AV19C703D9

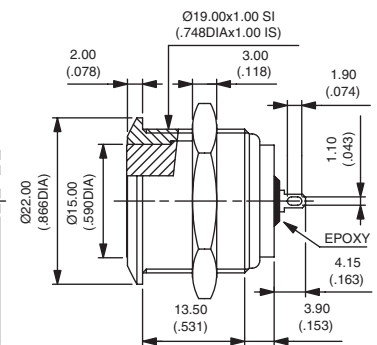
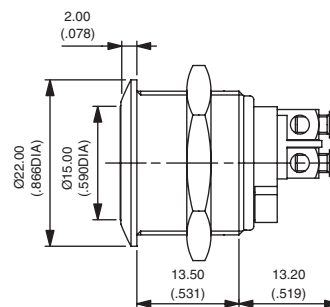

Flat actuator - illuminated

Hex nut 22 (.866) across flats



Solder lug terminals
AV09C7L3D2



Screw terminals
AV09C7L3D9

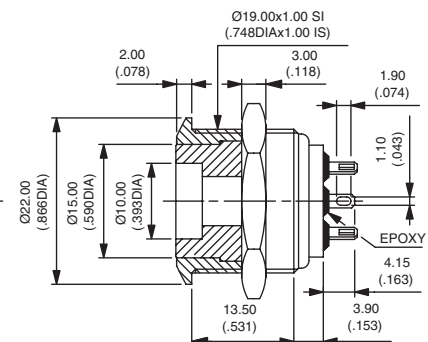
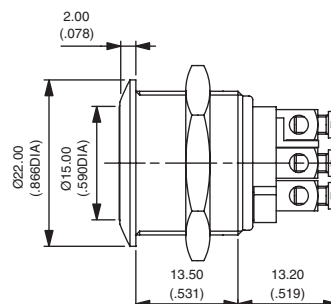



AV series

Snap-action security pushbutton switches Ø 19 mm (.748)

Options

After selecting basic model no.,
fill in last 4 boxes
with desired options.

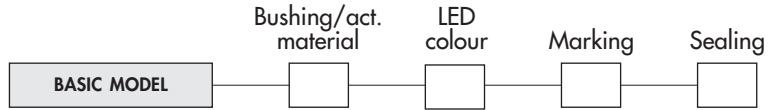

BUSHING/ACTUATOR MATERIALS

Non-illuminated models			Illuminated models		
CODE	BUSHING	ACTUATOR	CODE	BUSHING	ACTUATOR
00 (std)	Nickel plated brass	Nickel plated brass	00 (std)	Nickel plated brass	Nickel plated brass
10	Nickel plated brass	Stainless steel	20	Chrome plated brass	Chrome plated brass
30	Chrome plated brass	Stainless steel	40	Stainless steel	Stainless steel
40	Stainless steel	Stainless steel	50	Stainless steel	Nickel plated brass
80	Varnished polished brass	Varnished polished brass	80	Varnished polished brass	Varnished polished brass

LED COLOURS

Blank No LED

1 : Blue - **3** : Green - **5** : Yellow - **6** : Red - **7** : White - **9** : Amber - **2** : Red/green

MARKING

For flat or curved actuator.

- by engraving on non-illuminated brass actuator (stainless steel on request).
- by hot stamping on thermoplastic insert (illuminated actuators)

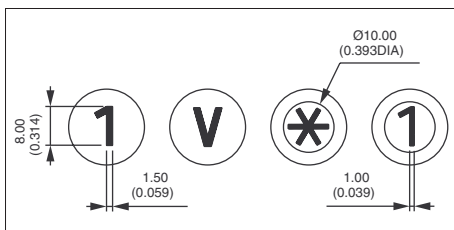

Select an option from each of the two tables below.

TYPE OF MARKING	
CODE	TYPE
0 to 9	Numbers 0 to 9
X	Symbol *
Y	Symbol #
A to N	Letters A to N
P to W	Letters P to W
0	Letter O

Letter O : same code and same design as number 0.
For special symbols, consult factory.
Minimum order : 500 pieces

COLOUR OF MARKING	
CODE	COLOUR
Non-illuminated actuators	
0 (standard)	Same as finish
2	Black
Note : a finished product supplied in version "0" cannot be modified to version "2".	
Illuminated actuators	
2	Black (on white)

SEALING

Blank No sealing

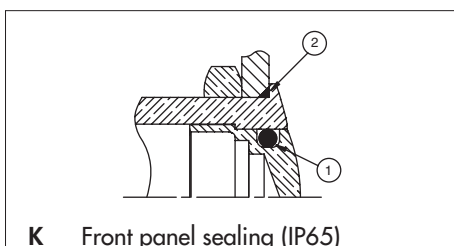

- ① internal gasket
- ② external gasket

AV series

Snap-action security pushbuttons Ø 19 mm (.748) with overmolded actuator

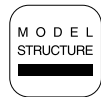

Illuminated and non-illuminated - momentary (NO)

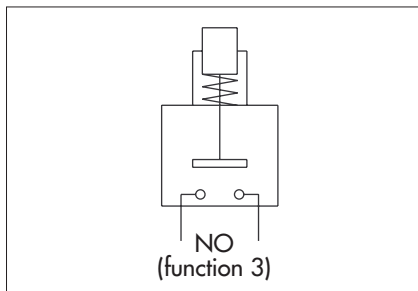

ORDER FORMAT

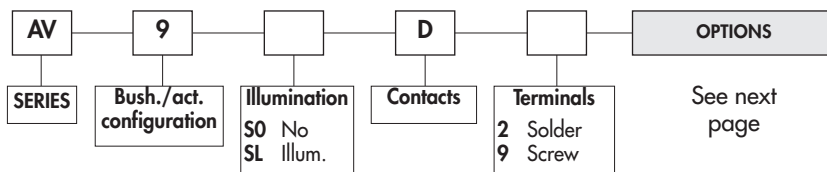

SPECIFICATIONS

- **Travel : 0,7 mm (.027) ± 0,1 mm (.003)**
- Max. current/voltage rating with resistive load : 50mA 24VDC
- LED voltage and consumption : 2-colour LED : 2V (3V max.) 20mA
Other colours : 2V (3V max.) 10mA
(a resistor must be series-connected by the user)**
- Initial contact resistance : 100 mΩ max.
- Insulation resistance : 1.000 MΩ min. at 500VDC
- Dielectric strength : 500 Vrms 50 Hz min. between terminals
2.000 Vrms 50 Hz min. between terminals and bushing
- Electrical life : 1.000.000 cycles at full load
- Operating force : 7 N ±2N
- Torque : 5 Nm min.- 14 Nm max. applied to nut
- Panel thickness : 1 (.039) to 6 mm (.236) max.
- Operating temperature : -30°C to +70°C
- Hand soldering : 270°C, 3 sec. max.
- Packaging unit : 40 pieces

** Resistor value = $\frac{\text{supply voltage} - \text{LED forward voltage}}{\text{LED forward current}}$

MATERIALS

- Case : PBT UL94-V0
- Terminals : brass, gold plated
- Contacts : gold plated dome
- Bushing : see next page
- Actuator : stainless steel, with thermoplastic overmolding
- LED

CUT-OUT

- Panel cut-out : Ø 19,2 mm (.755)
- Min. pitch for matrix mounting : 30 mm x 30 mm (1.181x1.181)

To order a product, select a basic model below and add the desired options selected on next page.

Flat actuator - solder lug terminals

Hex nut 22 (.866) across flats



Illuminated
AV9SLD2



Non-illuminated
AV9SOD2

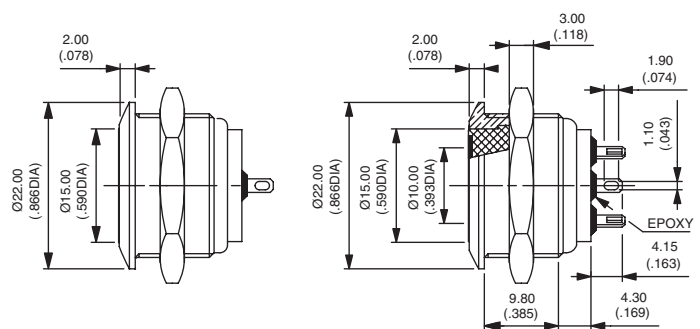

Also available with bushing Ø 22 (.866) : on request.

Flat actuator - screw terminals

Hex nut 22 (.866) across flats



Illuminated
AV9SLD9



Non-illuminated
AV9SOD9

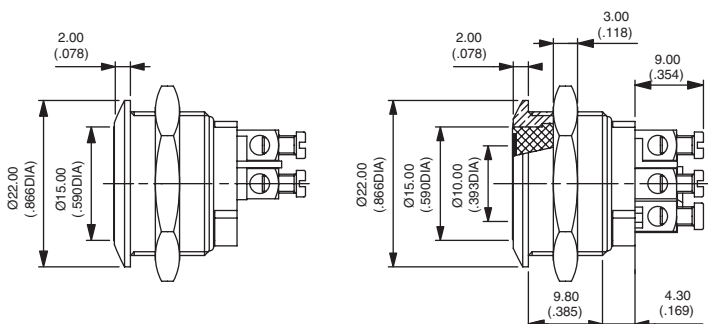

Also available with bushing Ø 22 (.866) : on request.



AV series

Snap-action security pushbuttons Ø 19 mm (.748) with overmolded actuator

Options

After selecting basic model no., fill in last 5 boxes with desired options.

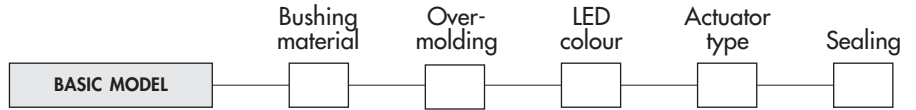

BUSHING MATERIALS

CODE	MATERIAL
0 (std)	Nickel plated brass
2	Chrome plated brass
4	Stainless steel
5	Gold plated brass
6	Chrome plated brass, satin
7	Chrome pl. brass, matt black
8	Varnished polished brass
9	Polished brass

OVERMOLDING COLOURS

CODE	COLOUR	CODE	COLOUR
1	Blue	6	Red
2	Black *	7	White
3	Green	8	Translucent
4	Grey *	9	Orange
5	Yellow		

* non-illuminated only

LED COLOURS

CODE	COLOUR
Blank	No LED
1	Blue
2	Red/green
3	Green
5	Yellow
6	Red
7	White
9	Amber

ACTUATOR STYLES

The ring and symbols are obtained by photochemical engraving of a stainless steel insert. The insert is then overmolded in the desired colour.

The following actuator styles are available. For other types, consult factory.

CODE	001	002	003	004	005
DESCRIPTION	Illuminated ring and disc	Illuminated ring	Arrow	Loudspeaker OFF	Double arrow
RING/SYMBOL					

SEALING

Blank No sealing

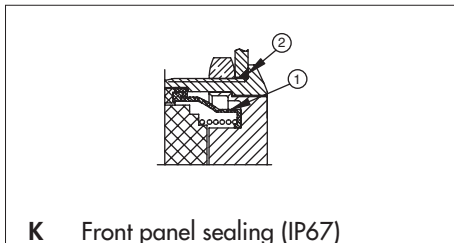

- ① internal membrane
- ② external gasket

K Front panel sealing (IP67)

AV series

Security pushbutton switches Ø 22 mm (.866)

Momentary (NO)

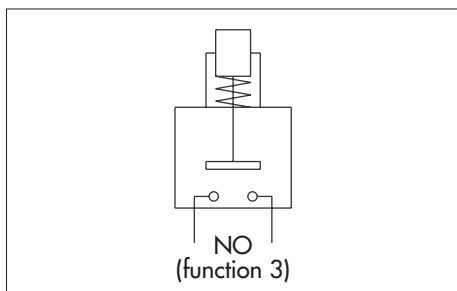

ORDER FORMAT

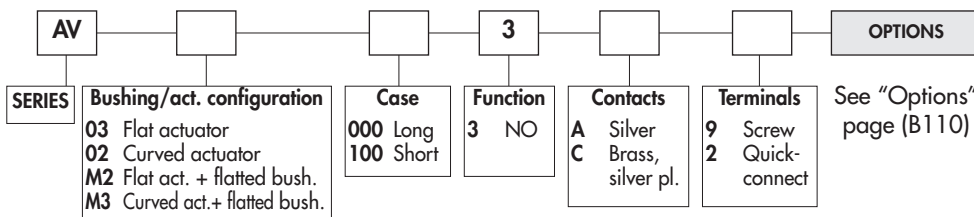

SPECIFICATIONS

- Max. current/voltage rating with resistive load :
 - A contacts : 4A 12VDC, 500.000 cycles
 - C contacts : 2A 48 VDC, 10.000 cycles
- Approved ratings of models with long case and A contacts (AV..000) :
 - UL-CSA : 4A 250VAC - 8A 125VAC - 6.000 cycles
- Initial contact resistance : 10 mΩ max. at 1A 2V
- Insulation resistance : 1.000 MΩ min. at 500VDC
- Dielectric strength : 2.000 Vrms 50 Hz min. between terminals and frame
2.000 Vrms 50 Hz min. between terminals
- Torque : 5 Nm min.- 14 Nm max. applied to nut
- Panel thickness : 1 (.039) to 11 mm (.433) max.
- Operating temperature : -30°C to +70°C
- Mechanical life : 1.000.000 cycles
- Hand soldering : 300°C, 3 sec. max.
- Packaging unit : 20 pieces

MATERIALS

- Case : PBT
- Contacts : silver (A) or brass, silver plated (C)
- Bushing and actuator : see "Options" page

CUT-OUTS

- Panel cut-out : Ø 22,2 mm (.874)
- Min. pitch for matrix mounting : 30 mm x 30 mm (1.181x1.181)

To order a product, select a basic model below or on next page and add the desired options.

BASIC MODEL

Flat actuator - short case - 48VDC - AV03100

Hex nut 25 (.984) across flats



Screw terminals
AV031003•9

Solder lug / quick-connect term.
AV031003•2



Screw terminals for wires 1,5 mm² max.

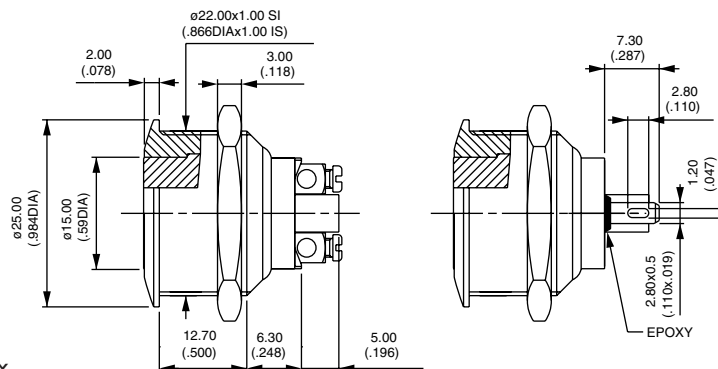

Contacts : replace • with A (silver) or C (silver plated brass).

Curved actuator - short case

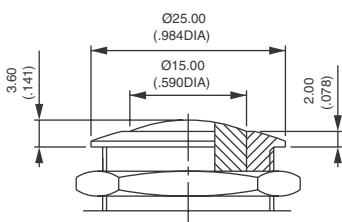

Screw terminals
AV021003•9

Solder lug / quick-connect terminals
AV021003•2

Flatted bushing - short case - AVM3 and AVM2

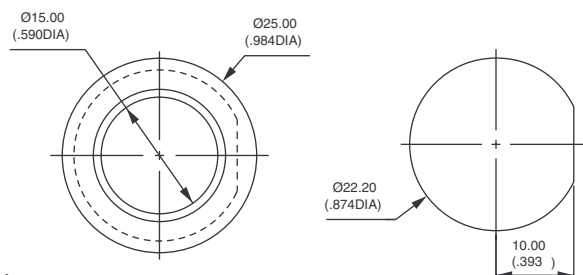

Flat actuator, screw terminals
AVM31003•9

Curved actuator, screw terminals
AVM21003•9



AV series

Security pushbutton switches Ø 22 mm (.866)

Momentary (NO) and momentary (NC)

Flat actuator - long case - 250VAC - UL/CSA - AV03000

Hex nut 25 (.984) across flats



Screw terminals
AV030003A9



To order switches marked **UL-CSA**, add "UU" at the end of model number.

Screw terminals for wires 1,5 mm² max.

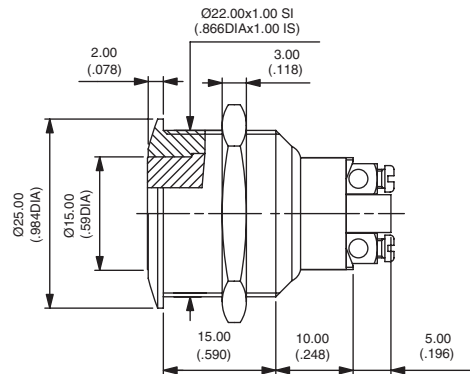

Curved actuator - long case

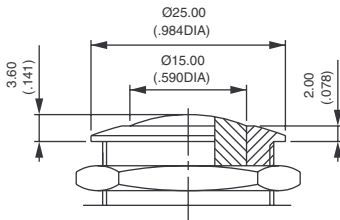

Screw terminals
AV020003A9

Flatted bushing - long case - AVM3 and AVM2

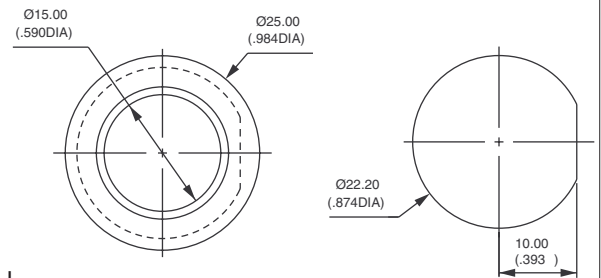

Flat actuator, screw terminals

AVM30003•9

Curved actuator, screw terminals

AVM20003•9

MOMENTARY NORMALLY CLOSED MODEL (NC)

Bushing Ø 22 (.866) - AV..1200

Hex nut 25 (.984) across flats

- Single pole, screw terminals, without marking
- Silver plated copper contacts (C)
- Max. current/voltage rating with resistive load : 2A 250VAC - 3A 125VAC - 2,5A 24VDC
- Dielectric strength : 2.000 Vrms 50 Hz min. betw. term. and frame
2.000 Vrms. 50 Hz min. between terminals
- Electrical life : 100.000 cycles at 0,3A 24VAC or DC
10.000 cycles at full load
- Packaging unit : 20 pieces

Flat actuator
AV031202C900

Curved actuator
AV021202C900

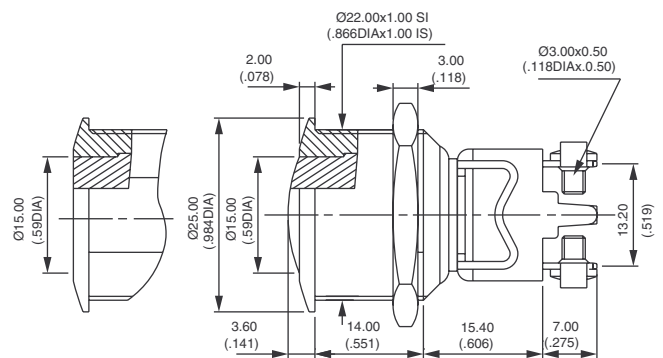

AV series

Security pushbutton switches Ø 22 mm (.866)

OPTIONS
● ● ●

Options

After selecting basic model number, fill in last 3 boxes with desired options.

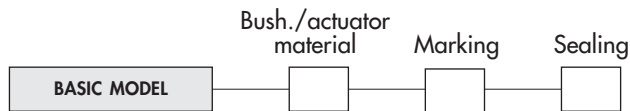

BUSHING/ACTUATOR MATERIALS

Flat or curved metal actuator

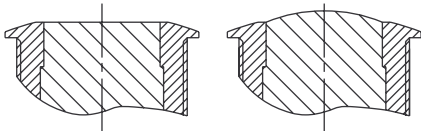

CODE	BUSHING	ACTUATOR
00 (standard)	Nickel plated brass	Nickel plated brass
10	Nickel plated brass	Stainless steel
12	Nickel plated brass	Chrome plated brass
20	Chrome plated brass	Chrome plated brass
30	Chrome plated brass	Stainless steel
40	Stainless steel	Stainless steel
80 **	Varnished polished brass	Varnished polished brass

Flat thermoplastic actuator

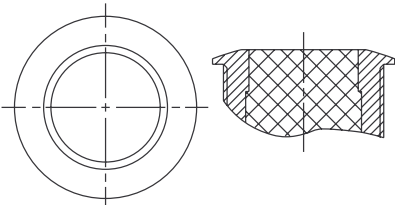

CODE	BUSHING	ACTUATOR COLOUR
0• (standard)	Nickel plated brass	Replace • with one of the following codes.
2•	Chrome plated brass	1 : blue - 1/4 : dark blue - 2 : black - 3 : green
8•	Varnished polished brass	4 : grey - 5 : yellow - 6 : red - 7/1 : white
		9 : orange

MARKING

- By engraving on flat or curved brass actuator (stainless steel on request)
- by hot stamping on flat thermoplastic actuator

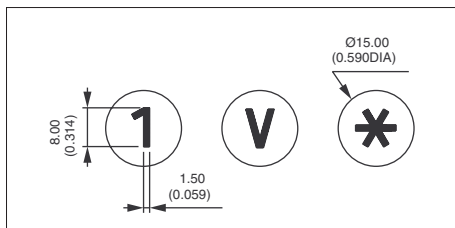

Select an option from each of the two tables below.

TYPE OF MARKING

CODE	TYPE
0 to 9	Numbers 0 to 9
X	Symbol *
Y	Symbol #
A to N	Letters A to N
P to W	Letters P to W
0	Letter O

Letter O : same code and same design as number 0.

For special symbols, consult factory.
Minimum order : 500 pieces

COLOUR OF MARKING

CODE	COLOUR
Brass actuator	
0 (standard)	Same as finish
2	Black

Note : a finished product supplied in version "0" cannot be modified to version "2".

CODE	COLOUR
Thermoplastic actuator	
2	Black
7	White

SEALING

Blank No sealing

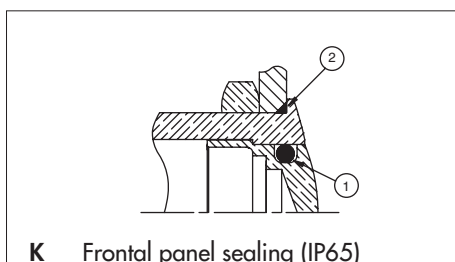

K Frontal panel sealing (IP65)

- ① internal gasket
- ② external gasket

AV series

New!

Security pushbutton switches Ø 22 mm (.866)

Latching - illuminated and non-illuminated

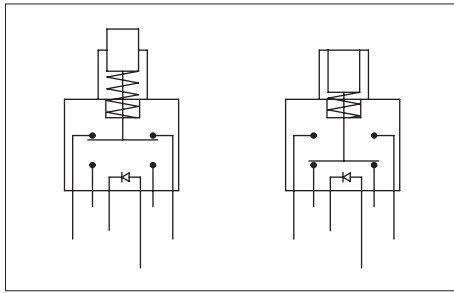

ORDER FORMAT

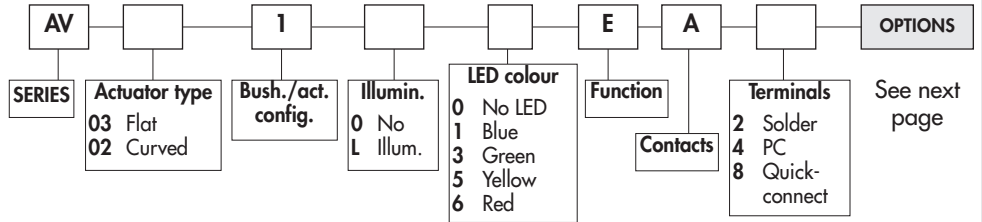

SPECIFICATIONS

- Max. current/voltage rating with resistive load : 2A 48 VDC
 - LED voltage and consumption : blue 3,5V 10mA, green : 2V 10mA yellow & red : 2V 20mA (a resistor must be series-connected by the user)**
 - Initial contact resistance : 50 mΩ max.
 - Insulation resistance : 1.000 MΩ min. at 500VDC
 - Dielectric strength : 1 000 Vrms 50 Hz min. between terminals 500 Vrms 50 Hz min. between terminals and bushing
 - Electrical life : 500.000 cycles at 2A 48VDC
 - Torque : 5 Nm min.- 14 Nm max. applied to nut
 - Panel thickness : 1 (.039) to 9 mm (.354) max.
 - Operating temperature : -30°C to +70°C
 - Mechanical life : 1.000.000 cycles
 - Hand soldering : 300°C, 4 seconds max.
 - Packaging unit : 20 pieces
- ** Resistor value = $\frac{\text{supply voltage} - \text{LED forward voltage}}{\text{LED forward current}}$

MATERIALS

- Case : PA6T UL94-V0
- Contacts : silver
- Actuator and bushing : see next page
- LED

CUT-OUT

- Panel cut-out : Ø 22,2 mm (.874)
- Min. pitch for matrix mounting : 30 mm x 30 mm (1.181x1.181)

To order a product, select a basic model below and add the desired options selected on next page.

Standard actuator position : the actuator is flush in the non-latched position and recessed in the latched position.

Non-illuminated - solder lug terminals

Hex nut 25 (.984) across flats



Flat actuator *
AV03100EA2 ON - ON

Curved actuator
AV02100EA2 ON - ON

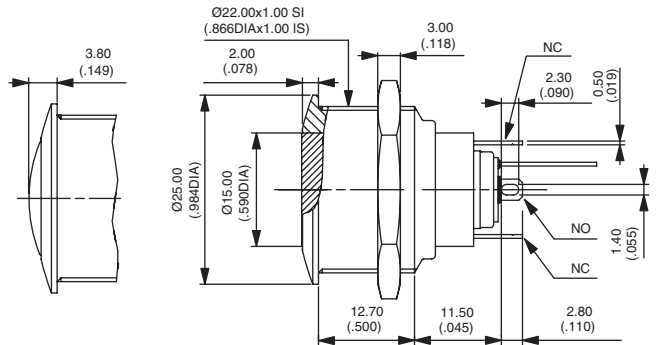

* Also available with prominent actuator in the non-latched position

Illuminated - solder lug terminals

Hex nut 25 (.984) across flats



Flat actuator
AV031L•EA2 ON - ON

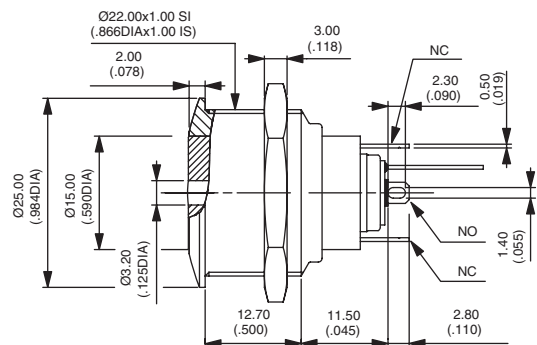

Replace • with desired LED colour.

AV series

Security pushbutton switches Ø 22 mm (.866)

New!

Latching - illuminated and non-illuminated

Straight PC terminals

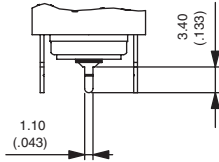

Replace 2 with 4 at the end of the model numbers shown on previous page.

Quick-connect terminals

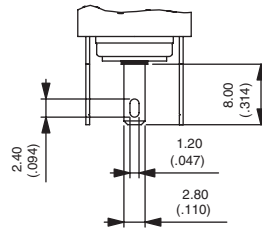

Replace 2 with 8 at the end of the model numbers shown on previous page.

B

After selecting basic model number, fill in last 2 boxes with desired options.

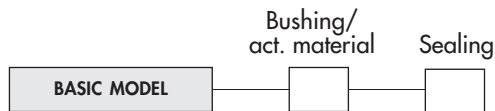

BUSHING/ACTUATOR MATERIALS

CODE	BUSHING	ACTUATOR
00 (std)	Nickel plated brass	Nickel plated brass
10	Nickel plated brass	Stainless steel
40	Stainless steel	Stainless steel
50	Stainless steel	Nickel plated brass

SEALING

Blank No sealing

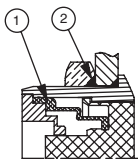

K Frontal panel sealing (IP65)

- ① elastomeric membrane
- ② external gasket



AV series

Security pushbutton switches Ø 22 mm (.866) or 24 mm (.944) with large actuator

Momentary (combined NC/NO)

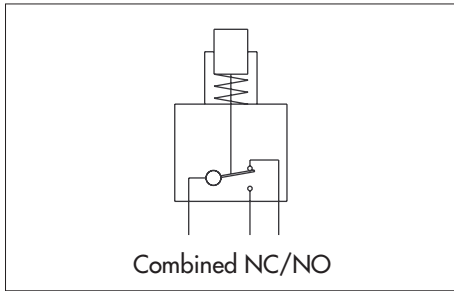

ORDER FORMAT

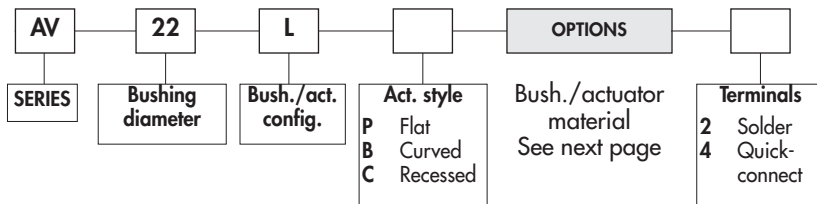

SPECIFICATIONS

- Max. current/voltage rating with resistive load : 5A 250VAC
- Initial contact resistance : 100 mΩ max.
- Insulation resistance : 1.000 MΩ min. at 500VDC
- Dielectric strength : 2.000 Vrms 50 Hz min. between terminals and frame
- Electrical life : 1.000.000 cycles at 1A 250VAC
100.000 cycles at full load
- Torque : 5 Nm min.- 14 Nm max. applied to nut
- Panel thickness : 1 (.039) to 6 mm (.236) max.
- Operating temperature : -20°C to +55°C
- Mechanical life : 3.000.000 cycles
- Front panel sealing : IP65
- Hand soldering : 300°C, 5 sec. max.
- Packaging unit : 20 pieces (except black chrome plated : 16 pieces)

MATERIALS

- Case : polyester, glass filled
- Contacts : silver/nickel alloy
- Bushing and actuator : see next page.

CUT-OUT

- Panel cut-out : Ø 22,2 mm (.874) or Ø 24,2 mm (.952)
- Min. pitch for matrix mounting : 30 mm x 30 mm (1.181x1.181) or 33 mm x 33 mm (1.299x1.299)

To order a product, select a basic model below or on next page and add the desired bushing/actuator materials.

BASIC MODEL

Flat actuator - AV22LP



Solder lug terminals
AV22LP••2



Quick-connect terminals
AV22LP••4



→ O-ring

Hex nut 25 (.984) across flats

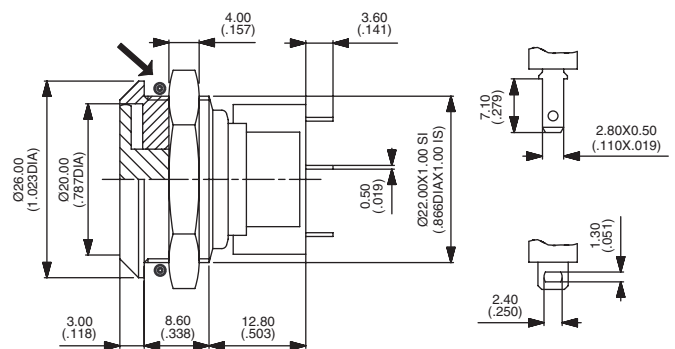

Curved actuator - AV22LB

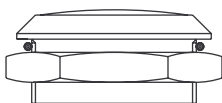

Solder lug terminals
AV22LB••2
Quick-connect terminals
AV22LB••4

Recessed actuator - AV22LC

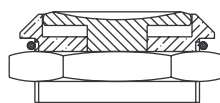

Solder lug terminals
AV22LC••2
Quick-connect terminals
AV22LC••4

AV series

Security pushbutton switches Ø 22 mm (.866) or 24 mm (.944) with large actuator

Momentary (combined NC/NO)

OPTIONS



BASIC MODEL

Flat actuator - low profile - AV24LP



Solder lug terminals
AV24LP••2



Quick-connect terminals
AV24LP••4



→ O-ring

Hex nut 27 (1.062) across flats

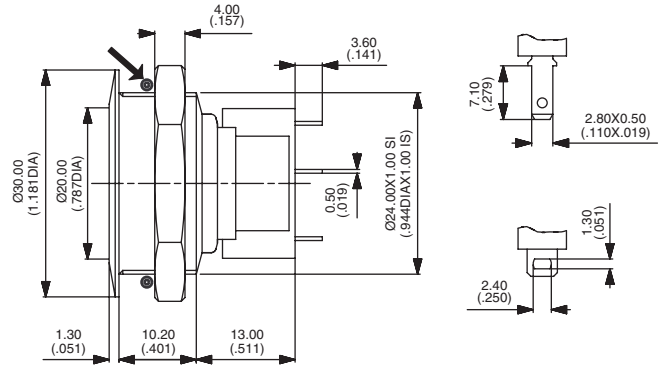

Curved actuator - AV24LB

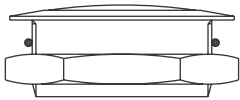

Solder lug terminals
AV24LB••2
Quick-connect terminals
AV24LB••4

Recessed actuator - AV24LC

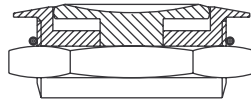

Solder lug terminals
AV24LC••2
Quick-connect terminals
AV24LC••4

BUSHING/ACTUATOR MATERIALS

Models with non-anodized actuator

CODE	BUSHING	ACTUATOR
40 (standard)	Stainless steel	Stainless steel
20	Chrome plated brass	Chrome plated brass

Models with anodized actuator

CODE	BUSHING	ACTUATOR COLOUR
1•	Black chrome plated brass	Replace • with one of the following codes :
2•	Chrome plated brass	1 : blue - 2 : black - 3 : pale green - 3F : dark green - 4 : natural - 5 : gold yellow
4•	Stainless steel	6 : red - 6B : maroon



AV series

Mushroom head security pushbutton switches Ø 22 mm (.866)

Momentary (combined NC/NO)

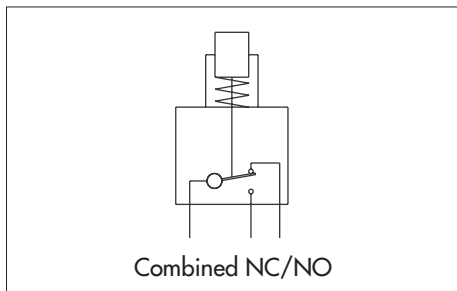

ORDER FORMAT

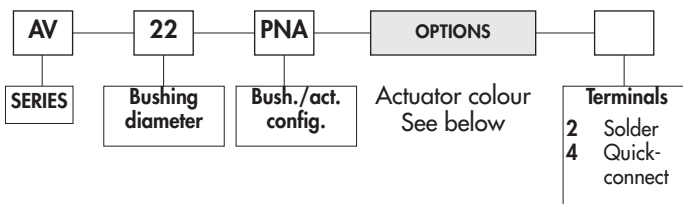

SPECIFICATIONS

- Max. current/voltage rating with resistive load : 5A 250VAC
- Initial contact resistance : 100 mΩ max.
- Insulation resistance : 1.000 MΩ min. at 500VDC
- Dielectric strength : 2.000 Vrms 50 Hz min. between terminals and frame
- Electrical life : 1.000.000 cycles at 1A 250VAC
50.000 cycles at full load
- Torque : 5 Nm min.- 14 Nm max. applied to nut
- Panel thickness : 1 (.039) to 6 mm (.236) max.
- Operating temperature : -20°C to +55°C
- Mechanical life : 1.000.000 cycles
- Front panel sealing : IP65
- Hand soldering : 300°C, 5 sec. max.
- Packaging unit : 16 pieces

MATERIALS

- Case : polyester, glass filled
- Contacts : silver/nickel alloy
- Bushing : brass, nickel plated
- Actuator : aluminium, anodized

CUT-OUT

- Panel cut-out : Ø 22,2 mm (.874)
- Min. pitch for matrix mounting : 30 mm x 30 mm (1.181x1.181)

To order a product, select a basic model below and add the desired actuator colour.

BASIC MODEL

Mushroom head actuator - AV22PNA



Solder lug terminals
AV22PNA•2



Quick-connect terminals
AV22PNA•4



→ O-ring

Hex nut 25 (.984) across flats

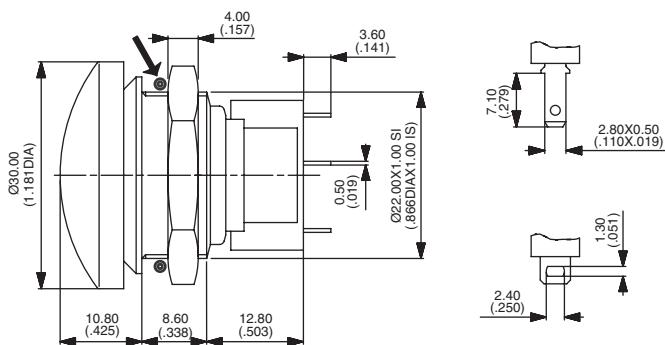

ACTUATOR ANODIZATION COLOURS

1 : blue - 2 : black - 3 : pale green - 3F : dark green - 4 : natural - 5 : gold yellow - 6 : red - 6B : maroon