

EGS

Electrical Group

**SOLA/  
HEVI-DUTY**

POWER PROTECTION

**S4K Industrial UPS™**

**USER MANUAL**



**700-3000VA  
120V**



# TABLE OF CONTENTS

<b>IMPORTANT SAFETY INSTRUCTIONS</b> . . . . .	<b>1</b>
<b>GLOSSARY OF SYMBOLS</b> . . . . .	<b>3</b>
<b>INTRODUCTION</b> . . . . .	<b>4</b>
<b>MAJOR COMPONENTS</b> . . . . .	<b>5</b>
Transient Voltage Surge Suppression (TVSS) and EMI/RFI Filters . . .	5
Rectifier/Power Factor Correction (PFC) Circuit . . . . .	5
Inverter . . . . .	5
Battery Charger . . . . .	6
DC to DC Converter . . . . .	6
Battery . . . . .	6
Dynamic Bypass . . . . .	6
S4K Industrial UPS (Rear View) . . . . .	7
<b>INSTALLATION</b> . . . . .	<b>8</b>
Preparation . . . . .	8
Tower UPS Installation . . . . .	8
Rack-Mount UPS Conversion and Installation . . . . .	9
External Battery Cabinet Installation . . . . .	12
<b>CONTROLS AND INDICATORS</b> . . . . .	<b>13</b>
ON/Alarm Silence/Manual Battery Test Button . . . . .	13
Standby/Manual Bypass Button . . . . .	14
Load/Battery Level Indicators (4 Green, 1 Amber) . . . . .	14
Fault Indicator LED (Red) . . . . .	14
Bypass Indicator LED (Amber) . . . . .	14
UPS ON Indicator LED (Green) . . . . .	14
Battery Indicator LED (Amber) . . . . .	14
AC Input Indicator LED (Green) . . . . .	14
Output Voltage Selection . . . . .	15
<b>OPERATING INSTRUCTIONS</b> . . . . .	<b>16</b>
Normal Mode Operation . . . . .	16
Battery Mode Operation . . . . .	16
Battery Recharge Mode . . . . .	16

<b>COMMUNICATIONS</b> . . . . .	<b>17</b>
Communications Interface Port . . . . .	17
Pin 4 - Remote Shutdown on Battery. . . . .	17
UPS Intelligent Communications . . . . .	18
<b>CONFIGURATION PROGRAM</b> . . . . .	<b>19</b>
S4K Industrial UPS Configuration Program Abilities . . . . .	19
What You Will Need . . . . .	19
<b>MAINTENANCE</b> . . . . .	<b>20</b>
Battery Replacement . . . . .	20
Internal Battery Replacement Procedures . . . . .	21
Fuse Replacement. . . . .	22
<b>TROUBLESHOOTING</b> . . . . .	<b>23</b>
<b>SPECIFICATIONS</b> . . . . .	<b>28</b>
<b>BATTERY CABINET SPECIFICATIONS</b> . . . . .	<b>30</b>
<b>BATTERY RUN TIMES</b> . . . . .	<b>31</b>

# IMPORTANT SAFETY INSTRUCTIONS



## WARNING

**OPENING OR REMOVING THE COVER MAY EXPOSE YOU TO LETHAL VOLTAGES WITHIN THIS UNIT EVEN WHEN IT IS APPARENTLY NOT OPERATING AND THE INPUT WIRING IS DISCONNECTED FROM THE ELECTRICAL SOURCE. OBSERVE ALL CAUTIONS AND WARNINGS IN THIS MANUAL. FAILURE TO DO SO MAY RESULT IN SERIOUS INJURY OR DEATH. REFER ALL UPS AND BATTERY SERVICE TO QUALIFIED SERVICE PERSONNEL. DO NOT ATTEMPT TO SERVICE THIS PRODUCT YOURSELF. NEVER WORK ALONE.**

## SAVE THESE INSTRUCTIONS

This manual contains important safety instructions. Read all safety, installation, and operating instructions before operating the Uninterruptible Power System (UPS). Adhere to all warnings on the unit and in this manual. Follow all operating and user instructions. Individuals without previous training can install and operate this equipment.

It is not intended for use with life support and other designated “critical” devices. Maximum load must not exceed that shown on the UPS rating label. The UPS is designed for data processing equipment. If uncertain, consult your local distributor or Sola/Hevi-Duty representative.

This UPS is designed for use on a properly grounded (earthed), 100-127 VAC, 50 Hz or 60 Hz supply.

**ELECTROMAGNETIC COMPATIBILITY**—The S4K Industrial UPS™ Series complies with the limits for a CLASS A DIGITAL DEVICE, PURSUANT TO Part 15 of FCC rules. Operation is subject to the following two conditions: (1) This device may not cause harmful interference, and (2) this device must accept any interference received, including interference that may cause undesired operation. Operating this device in a residential area is likely to cause harmful interference that users must correct at their own expense.

Operate the UPS in an indoor environment only in an ambient temperature range of 32°F to +104°F (0°C to +40°C). Install it in a clean environment, free from moisture, flammable liquids, gases and corrosive substances.

This UPS contains no user serviceable parts except the internal battery packs and the rear input line fuses. The UPS ON/Standby push buttons do not electrically isolate internal parts. Under no circumstances attempt to gain access internally other than to replace the batteries due to risk of electric shock or burn. Do not continue to use the UPS if the front panel indications are not in accordance with these operating instructions or if the UPS performance alters in use. Refer all faults to your local distributor, Sola/Hevi-Duty representative or Sola/Hevi-Duty Technical Support Group.

Servicing of batteries should be performed or supervised by personnel knowledgeable of batteries and the required precautions. Keep unauthorized personnel away from the batteries. **PROPER DISPOSAL OF BATTERIES IS REQUIRED. REFER TO YOUR LOCAL LAWS AND REGULATIONS FOR BATTERY DISPOSAL REQUIREMENTS.**

Never block or insert any object into the ventilation holes or other openings of the UPS.

DO NOT CONNECT equipment that could overload the UPS or demand DC current from the UPS, for example: electric drills, vacuum cleaners, laser printers, hair dryers or any appliance using half-wave rectification.

Storing magnetic media on top of the UPS may result in data loss or corruption.

Turn the UPS off and isolate the UPS before cleaning; use only a soft cloth, never liquid or aerosol cleaners. Keep the front and rear vents free of dust accumulation that could restrict airflow.

When replacing batteries, replace with the same Sola/Hevi-Duty authorized replacement battery kits.



**CAUTION**

**Do not dispose of battery or batteries in a fire. The battery may explode.**

**Do not open or mutilate the battery or batteries.**

**Released electrolyte is harmful to skin and eyes. It may be toxic.**



**CAUTION**

**A battery can present a risk of electrical shock and high short circuit current. The following precautions should be observed when working on batteries:**

- **Remove watches, rings, or other metal objects.**
- **Use tools with insulated handles.**

# GLOSSARY OF SYMBOLS



**Risk of electrical shock**



**Indicates caution followed by important instructions**



**AC input**



**AC output**



**Requests the user to consult the manual**



**Indicates the unit contains a valve-regulated lead acid battery**



**Recycle**



**DC voltage**



**Equipment grounding conductor**



**Bonded to ground**



**AC voltage**



**ON**



**Standby**

# INTRODUCTION

Congratulations on your choice of the Sola/Hevi-Duty S4K Industrial Uninterruptible Power System (UPS). It provides conditioned power to microcomputers and other sensitive electronic equipment.

Upon generation, AC power is clean and stable. However, during transmission and distribution it may be subject to voltage sags, spikes, or complete power failure that may interrupt computer operations, cause data loss, or even damage equipment. The S4K Industrial UPS protects equipment from these disturbances.

The S4K Industrial UPS comes in nominal power ratings of 700, 1000, 1500, 2000 and 3000 VA. Complete model specifications appear at the end of this manual.

The S4K Industrial UPS is a compact, "on-line" UPS. An on-line UPS continuously conditions and regulates its output voltage, whether utility power is present or not. It supplies connected equipment with clean sinewave power. Sensitive electronic equipment operates best from sinewave power.

For ease of use, the S4K Industrial UPS features a light-emitting diode (LED) display to indicate either load percentage or battery capacity depending upon the mode of operation. It also provides self-diagnostic tests, a combination On/Alarm Silence/Manual Battery Test button, a Standby button, user configurable program, and two levels of alarms when the unit is operating on battery.

The S4K Industrial UPS has an interface port for communication between the UPS and a network server or other computer systems. This port provides detailed operating information including voltages, currents, and alarm status to the host system when used in conjunction with MultiLink™ software. MultiLink software can also remotely control UPS operation.



# MAJOR COMPONENTS

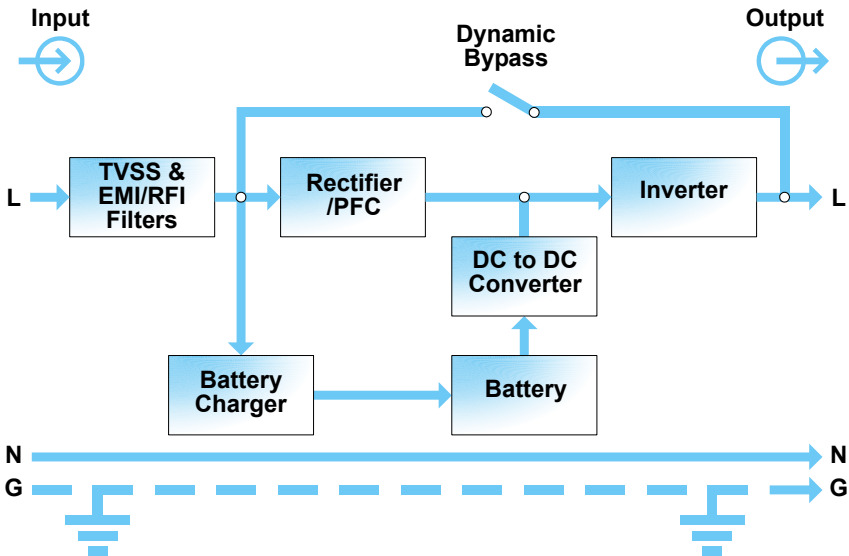

## TRANSIENT VOLTAGE SURGE SUPPRESSION (TVSS) AND EMI/RFI FILTERS

These UPS components provide surge protection and filter both electromagnetic interference (EMI) and radio frequency interference (RFI). They minimize any surges or interference present in the utility line and keep the sensitive equipment protected.

## RECTIFIER/POWER FACTOR CORRECTION (PFC) CIRCUIT

In normal operation, the rectifier/power factor correction (PFC) circuit converts utility AC power to regulated DC power for use by the inverter while ensuring that the waveshape of the input current used by the UPS is near ideal. Extracting this sinewave input current achieves two objectives:

- The utility power is used as efficiently as possible by the UPS.
- The amount of distortion reflected on the utility is reduced.

This results in cleaner power being available to other devices in the building not being protected by the S4K Industrial UPS.

## INVERTER

In normal operation, the inverter utilizes the DC output of the power factor correction circuit and inverts it into precise, regulated sinewave AC power. Upon a utility power failure, the inverter receives its required energy from the battery through the DC to DC converter. In both modes of operation, the UPS inverter is on-line and continuously generating clean, precise, regulated AC output power.

## **BATTERY CHARGER**

The battery charger utilizes energy from the utility power and precisely regulates it to continuously “float charge” the batteries. The batteries are being charged whenever the S4K Industrial UPS is plugged in, even when the UPS is not turned on.

## **DC TO DC CONVERTER**

The DC to DC converter utilizes energy from the battery system and raises the DC voltage to the optimum operating voltage for the inverter. This allows the inverter to operate continuously at its optimum efficiency and voltage, thus increasing reliability.

## **BATTERY**

The S4K Industrial UPS utilizes valve-regulated, nonspillable, flame retardant, lead acid batteries. To maintain battery design life, operate the UPS in an ambient temperature of 68°F to 77°F (20°C to 25°C). Optional external battery cabinets are available to extend battery run times.

## **DYNAMIC BYPASS**

The S4K Industrial UPS provides an alternate path for utility power to the connected load in the unlikely event of a UPS malfunction. Should the UPS have an overload, overtemperature, or UPS failure condition, the UPS automatically transfers the connected load to bypass. Bypass operation is indicated by an alarm and illuminated Bypass LED (other LEDs may be illuminated to indicate the diagnosed problem). To manually transfer the connected load from the inverter to bypass, press the Standby button once.



### **NOTE**

*The bypass power path does NOT protect the connected equipment from disturbances on the utility supply.*

# S4K INDUSTRIAL UPS (REAR VIEW)

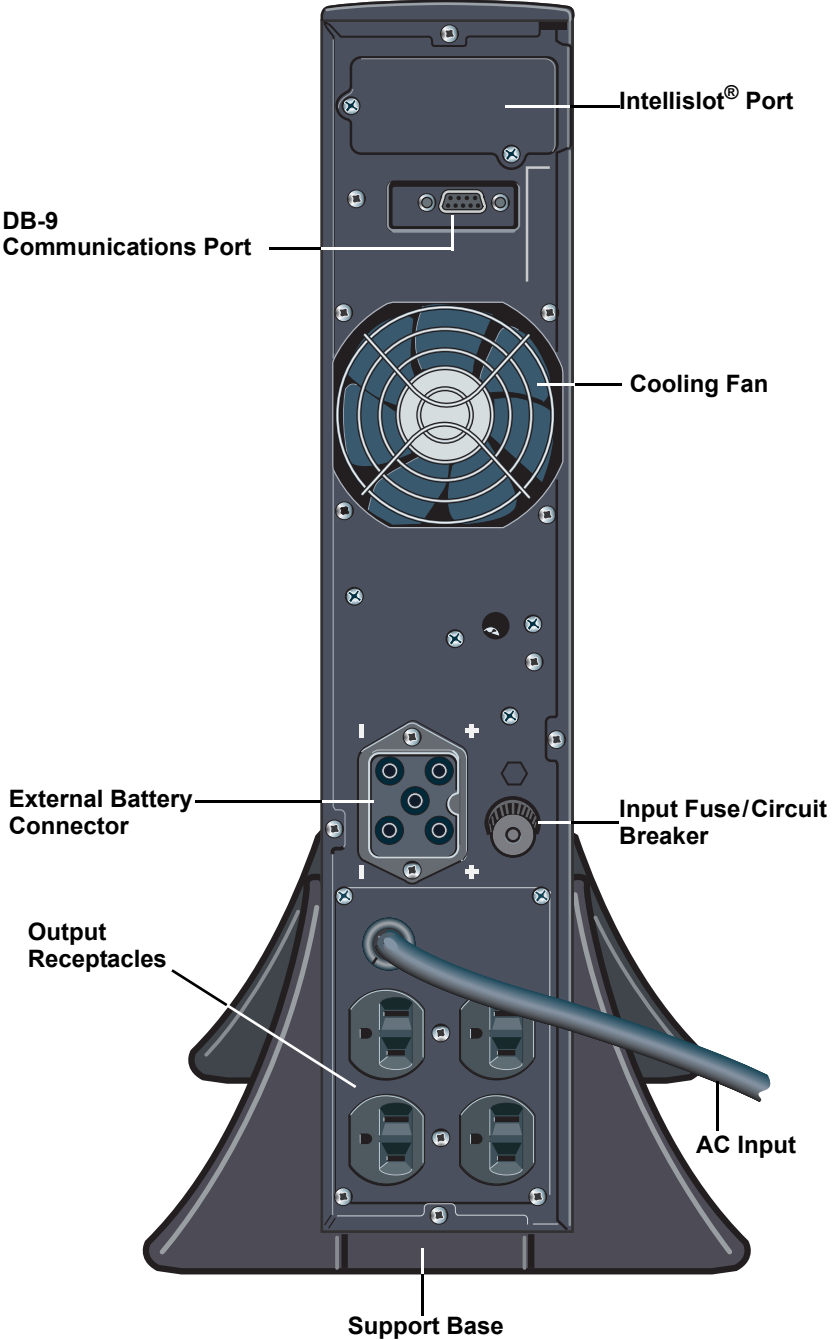

# INSTALLATION

## PREPARATION

1. Visually inspect the UPS for freight damage. Report damage to the carrier and your local distributor or Sola/Hevi-Duty representative.



### CAUTION

The UPS is heavy (see Specifications section). Take proper precautions when lifting or moving it.

2. Decide where to place the S4K Industrial UPS. Install the UPS indoors in a controlled environment, where it cannot be accidentally turned off. Place it in an area of unrestricted airflow around the unit, away from water, flammable liquids, gases, corrosives, and conductive contaminants. Maintain a minimum clearance of 4 inches (100mm) in the front and rear of the UPS. Maintain an ambient temperature range of 32°F to 104°F (0°C to 40°C).



### NOTE

*UPS operation in temperatures above 77°F (25°C) reduces battery life.*

3. The S4K Industrial UPS may be installed in either a tower configuration or in a rack, depending on available space and use considerations. Determine the type of installation and follow the appropriate instructions in either **Tower UPS Installation** or **Rack-Mount UPS Conversion and Installation**.

## TOWER UPS INSTALLATION

When using the S4K Industrial UPS in a tower configuration, use the included support base (shown below, left) to stabilize the UPS.

If any battery cabinets are added, they will include spacers to accommodate the additional cabinets (shown below, right).

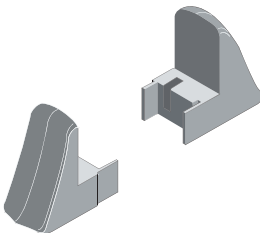

Support base

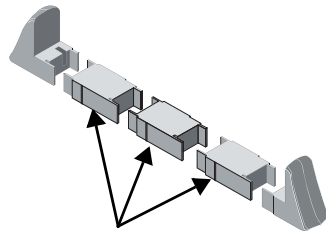

Spacers added to support base to accommodate additional battery cabinets

# RACK-MOUNT UPS CONVERSION AND INSTALLATION



## NOTE

*When rack-mounted, the UPS must be supported by a shelf, brackets or slide rails on each side. The rack-mount handles WILL NOT support the weight of the UPS. They are used to move the UPS into and out of the rack.*

1. For slide rail installations, first remove the top/side fin. Slide the top/side fin forward, then lift it up to remove. If desired, install the optional rack-mount handles that were shipped with the UPS.

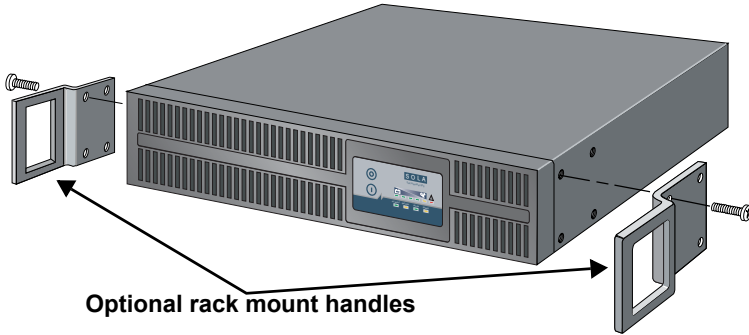

Securing hardware and slide rails are sold separately. Contact your local distributor or Sola/Hevi-Duty representative for these additional options and any assistance needed.

2. Unpack the two slide assemblies and mounting hardware. The slide assemblies are interchangeable between left-hand or right-hand. Remove the inner member of each slide assembly (as seen at right) by extending it to its outermost position, depressing the locking mechanism and then pulling the inner member from the slide assembly.

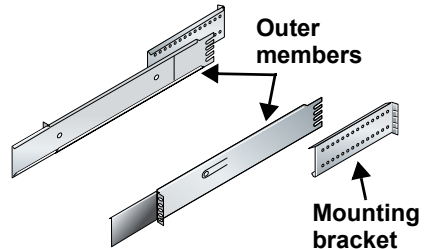
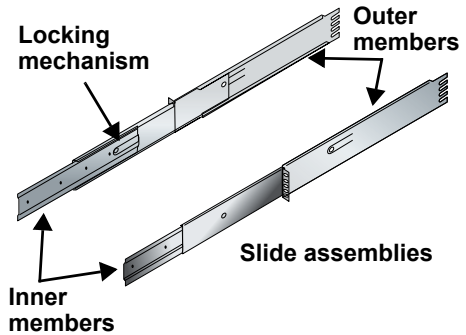

3. Fasten the inner members from **Step 2** to the UPS on both sides (see below) with eight screws provided in the accessories box of the UPS.

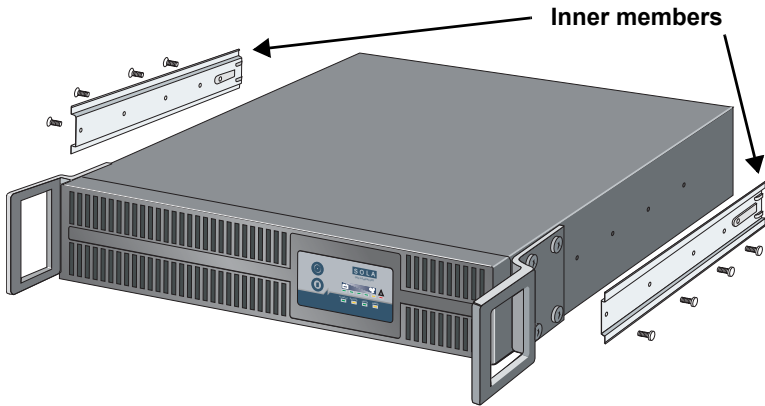

4. Attach the two mounting brackets to the rack's mounting rails. The brackets allow adjustment of up to eight inches of the slide assembly mounting position, front-to-back, on the rack-mounting rails. Determine which adjustment holes to use on the bracket, and attach it to the slide assembly on the stationary outer member using the bar nuts and #10-32 binding head screws provided in the slide assembly kit. Insert two screws from the inside of each slide assembly.



#### NOTE

*Bar nuts may not be required on all installations, depending on the type of racks being used.*

5. Install the slide assemblies, with brackets attached in **Step 4** into the rack enclosure. The return flanges on the mounting brackets and outer members fit to the inside of the rack-mounting rails.
6. Insert the eight screws loosely (finger-tight). Make sure the slide assemblies are in the same alignment position on all four rack-mounting rails. After checking alignment, **TIGHTEN ALL SCREWS**.

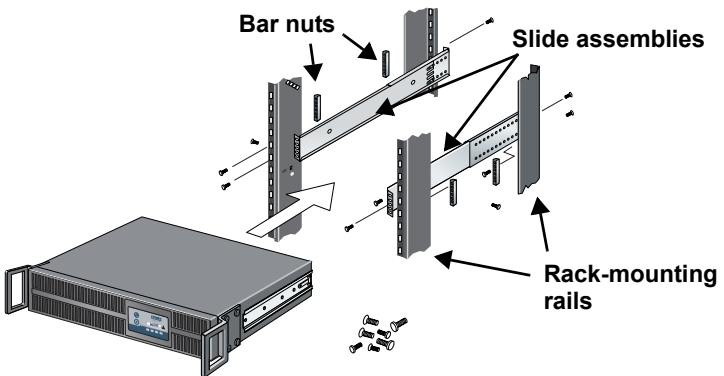

- Insert the UPS, with inner members attached from **Step 3**, into the slide assemblies. You may need to depress the locking mechanisms on the inner and outer members of the slide assemblies to allow the slides to retract. The UPS should move smoothly forward and backward on the slide assemblies. If not, recheck alignment.



**CAUTION**

**Reduce the risk of tipping the rack enclosure by placing the UPS in the lowest possible rack position.**

- To orient the display for horizontal viewing, remove the front plastic bezel by pulling forward evenly on both sides. The unit has two front panel overlays. Remove the outer overlay (used for tower installation). This reveals a horizontally oriented front panel overlay for rack mounting. Snap the front bezel back into place.
- Once the UPS is installed in the rack, the load may be connected. Ensure the load equipment is turned off; plug all loads into the output receptacles on the rear of the UPS.
- Plug the UPS into a dedicated wall receptacle properly protected by a circuit breaker or fuse in accordance with national and local electrical codes. Use a 15 amp rated device for the 700, 1000, or 1500 VA units, 20 amp for the 2000 VA, and 30 amp for the 3000 VA. The wall receptacle must be grounded.
- Turn ON the UPS by pressing the ON button; then turn on the connected load equipment. The UPS is now providing conditioned power to your equipment.

**Vertical overlay for tower UPS**



**Horizontal overlay for rack UPS**

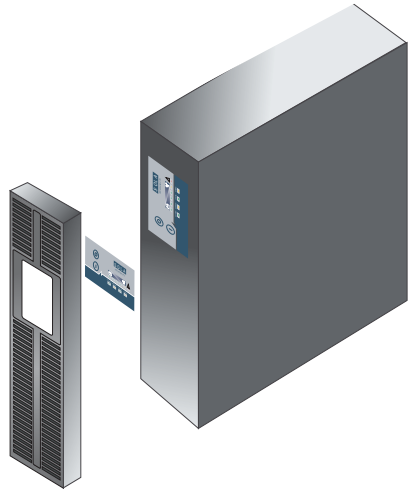

## EXTERNAL BATTERY CABINET INSTALLATION

Optional Sola/Hevi-Duty external battery cabinets may be connected to the UPS to provide additional battery run time. External battery cabinets are designed to be placed all on one side of the UPS or stacked beneath the UPS. There is no limit to the number of external battery cabinets that can be used but each cabinet will increase the battery recharge time.



### CAUTION

**The external battery cabinet(s) are heavy (see Specifications section). External battery cabinets can be used in rack-mount or tower configuration. Take proper precautions when lifting them.**

1. Visually inspect the external battery cabinet for freight damage. Report damage to the carrier and your local distributor or Sola/Hevi-Duty representative.
2. For slide rail installations, first remove the top/side fin. Top/side fin slides forward and then lift up to remove. Optional rack-mount handles are shipped with the external battery cabinet and may be installed at this time if desired.
3. Securing hardware and slide rails are sold separately. Please contact your local distributor or Sola/Hevi-Duty representative for these additional options and any assistance needed. Fasten the slides into position with the screws per the instructions included with the slide rails.
4. Use the enclosed support bases for the tower option to prevent tip-over. One additional set of support base extensions ships with each external battery cabinet.
5. Connect the supplied external battery cabinet cable to the rear of the external battery cabinet, then to the rear of the UPS.
6. Turn the battery breaker on the rear of the external battery cabinet "ON".
7. The UPS is now equipped with additional backup battery runtime. For approximate battery runtimes refer to the **Battery Run Times** charts in this manual.

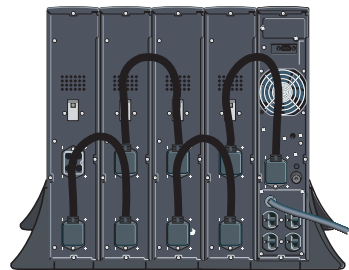
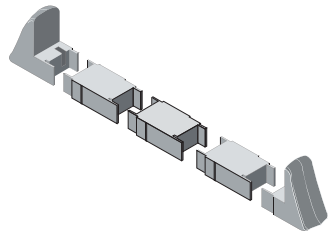

### NOTE

*You must use the included Configuration Program to program the UPS for the number of external battery cabinets connected.*



# CONTROLS AND INDICATORS

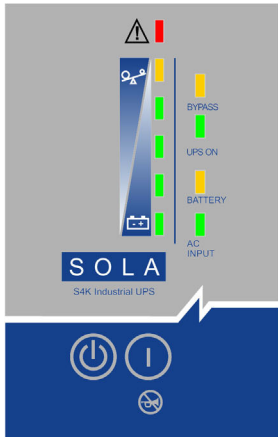

All LEDs illuminated for illustrative purposes only.

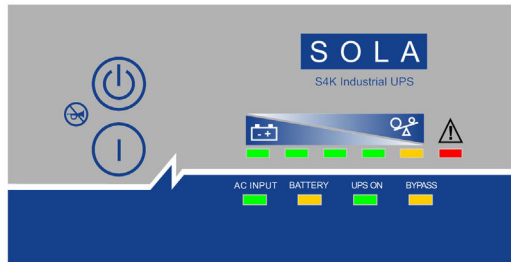

## ON/Alarm Silence/Manual Battery Test Button

This button controls output power to connected load(s) and has three functions:

- ON
- Alarm Silence
- Manual Battery Test

**ON** - Pressing this button will start up the UPS in order to provide conditioned and protected power.

**Alarm Silence** - To silence alarms, press this button for at least one second. After the alarm is silenced, the S4K Industrial UPS will reactivate the alarm system to alert of additional problems.



### NOTE

*The LOW BATTERY and BYPASS reminder alarms CANNOT be silenced.*

**Manual Battery Test** - To initiate a manual battery test, press the ON button for at least one second while operating from utility power with no alarm conditions present.

- If only three of the five battery LEDs illuminate, allow the UPS to recharge the batteries for 24 hours.
- After 24 hours, retest the batteries.
- After the batteries have been retested, if only three of the five battery LEDs illuminate, contact your local distributor, Sola/Hevi-Duty representative or Sola/Hevi-Duty Technical Support Group.

## Standby/Manual Bypass Button



This button controls output power to connected load(s) and has dual functions: Standby and Manual Bypass.



### CAUTION

**Pressing the Standby/Manual Bypass button once will cause the load to be transferred to bypass power.**

**Pressing the Standby/Manual Bypass button a second time within 4 seconds will result in loss of power to the output receptacles and connected loads. Perform all necessary shutdown procedures on connected loads before pressing this button twice.**

## Load/Battery Level Indicators (4 Green, 1 Amber)

The Load/Battery Level indicators have dual functions. During normal mode operation LED indicators display the approximate electrical load placed upon the UPS; and during battery mode operation LED indicators display approximate battery capacity.

The S4K Industrial UPS is equipped with automatic and remote battery test features. The automatic test occurs every 14 days (this option is user configurable) if utility has not been interrupted. Should the battery fail this test, the red Fault indicator LED along with the A and C diagnostic LEDs will illuminate and an alarm will sound (refer to **Troubleshooting** section).

The remote test feature functions with MultiLink™ 3 software and can remotely initiate the battery test.

### Fault Indicator LED (Red)

The Fault indicator LED is illuminated if the UPS has detected a problem. Also, one or more of the load/battery level indicators may be illuminated (refer to **Troubleshooting** section).

### Bypass Indicator LED (Amber)

The Bypass indicator LED is illuminated when the UPS is operating from bypass power. An alarm will sound indicating the UPS detected a problem, or the manual bypass function has been activated.

### UPS ON Indicator LED (Green)

The UPS ON indicator LED is illuminated when the UPS inverter is operating and supplying power to your connected loads.

### Battery Indicator LED (Amber)

The Battery indicator LED is illuminated when the UPS is operating on battery.

### AC Input Indicator LED (Green)

The AC Input indicator LED is illuminated when utility power is available and within the input specifications.

## Output Voltage Selection

The Output Voltage is user configurable, and is designed to allow selecting or changing the desired output voltage to match the utility via the S4K Configuration Program provided with the UPS. The settings to choose from are 100, 110, 115, 120, and 127 VAC output. The factory default setting is 120 VAC.



### CAUTION

**Never change the voltage settings while the UPS is ON and powering connected loads.**



### NOTE

*Setting output voltage to 100 VAC will cause the UPS unit to be derated (700/1000 VA to 90%, 1500/2000/3000 VA to 80%) of the VA and Watt ratings listed in the **Specifications** section.*

# OPERATING INSTRUCTIONS

## NORMAL MODE OPERATION

During normal operation, utility power provides energy to the UPS. The filters, power factor correction circuit and the inverter process this power to provide computer grade power to connected loads. The UPS maintains the batteries in a fully charged state.

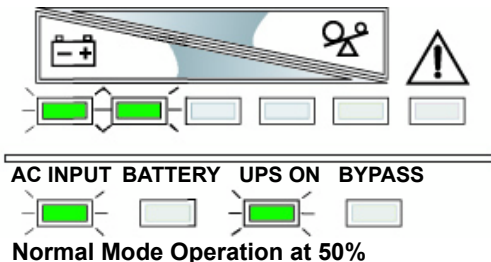

The four green LEDs indicate an approximate level of load in 25% increments. If the UPS becomes loaded beyond full rating, the fifth (amber) LED indicator will illuminate and sound an audible alarm. The display template indicates the percentage of load (50% of load shown in example) on the UPS output.

## BATTERY MODE OPERATION

Battery mode occurs in event of an extreme input voltage condition or complete utility failure. The battery system supplies power through the DC to DC converter to the inverter to generate power for the connected load.

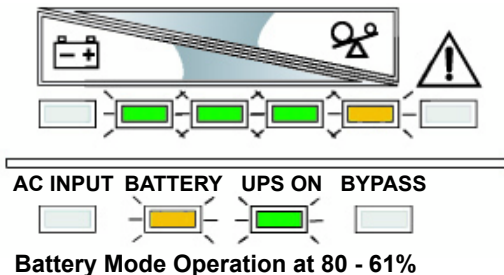

During battery mode an alarm sounds every 10 seconds.

This will change to two beeps every 5 seconds when battery runs low (approximately 2 minutes remaining, but this is user configurable). The AC Input LED will extinguish, and the Battery LED will illuminate to warn that a utility problem has occurred. Each load/battery level indicator represents a 20% capacity level. As capacity decreases, fewer indicators remain illuminated. Refer to **Troubleshooting** section.

For approximate battery run times, refer to **Battery Run Times** charts in this manual. To increase this time, turn off non-essential pieces of equipment (such as idle computers and monitors) or add the optional external battery cabinet.



### CAUTION

Turning off the UPS while in battery mode will result in loss of output power.

## BATTERY RECHARGE MODE

Once utility power is restored, the UPS resumes normal operation. At this time, the Battery Charger begins recharging the battery.

# COMMUNICATIONS

## COMMUNICATIONS INTERFACE PORT

The S4K Industrial UPS contains a standard DB-9 serial port female connector located on the rear of the UPS unit. Several signals are provided on this port and are assigned as follows:

Pin	Assignment Description
1	Low Battery (open collector)
2	UPS TxD (typical RS-232 levels)
3	UPS RxD (typical RS-232 levels)
4	Remote Shutdown (5-12VDC, 10-24 mA max); battery operation
5	Common
6	Remote Shutdown (short to pin 5); all modes of operation
7	Low Battery (open emitter)
8	Utility Fail (open emitter)
9	Utility Fail (open collector)

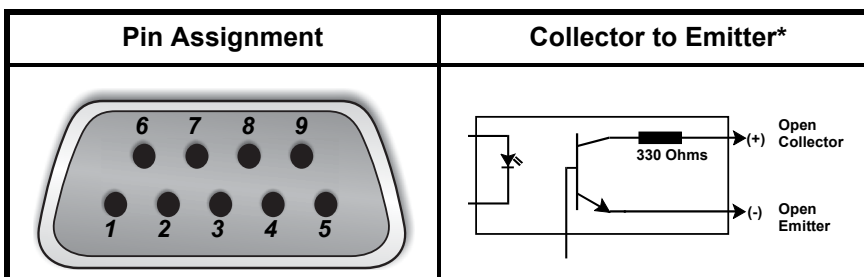

\*Maximum voltage and current on pins 1, 7, 8, and 9 is 60V DC; 10.0 mA.

### PIN 4 - REMOTE SHUTDOWN ON BATTERY

1. This pin is functional only when the UPS is in battery mode. If the UPS is being powered by the utility, Pin 4 will ignore any signal on this pin.
2. Pin 4 requires a 5-12 VDC signal to shutdown. This normally comes from the serial port using Sola/Hevi-Duty's contact closure cable. It cannot be used with just a contact closure unless the relay is used to switch a voltage source. A 5-12 VDC signal for 1.5 seconds or greater is required to signal a shutdown. Signals for less than 1.5 seconds will be ignored. After Pin 4 receives a shutdown signal for 1.5 seconds, the command cannot be canceled.

3. A battery shutdown signal on Pin 4 will NOT cause an immediate shutdown. A shutdown signal will start a 2-minute shutdown timer. The timer cannot be stopped. After 2 minutes, the UPS will shut down.
4. If the utility returns during the 2-minute timer countdown, the shutdown timer will continue until the end of 2 minutes and the UPS will turn OFF. The UPS must remain OFF for at least 10 seconds even if AC input power returns before the UPS turns OFF. This serves to reset and restart the server.

Whether the UPS turns back ON when power is restored depends on the auto-restart setting: enabled or disabled.

If the auto-restart is disabled, the UPS will not restart after performing the 2-minute shutdown delay.

## UPS INTELLIGENT COMMUNICATIONS

The S4K Industrial UPS is equipped with an Intellislot® port to provide advanced communication and monitoring options.

MultiLink™ software continually monitors the UPS and can shut down your computer or server in the event of an extended power failure.

MultiLink can also be configured for use without the serial cable when the Intellislot SNMP/Web Card is installed in the UPS. Additionally, MultiLink can be configured to coordinate shutdown across the network with other computers running MultiLink when you purchase a MultiLink License Kit. For more information about the Intellislot SNMP/Web Card and MultiLink License Kits, visit our web site ([www.solaheviduty.com](http://www.solaheviduty.com)) or contact your local distributor or Sola/Hevi-Duty representative.

Several option cards are available for use in the Intellislot port of the S4K Industrial UPS. The Intellislot SNMP/Web Card provides SNMP and web-based monitoring and control of the UPS across the network.

The Intellislot MultiPort 4 Card allows you to install MultiLink software on four computers and coordinate shutdown in the event of a power failure.

The Intellislot Relay Card provides five dry contact relay outputs for custom wired applications and delivers support for built-in shutdown for AS/400 systems.



### CAUTION

**To maintain safety (SELV) barriers and for electromagnetic compatibility, signal cables should be segregated and run separate from all other power cables, where applicable.**

# CONFIGURATION PROGRAM

This is a new feature included with the new S4K Industrial UPS line. Several UPS settings that were previously not available or required custom manufacturing may now be modified using this program. For most users, the factory default settings will be adequate. This manual illustrates the features available for modification, as well as the factory default setting.

## S4K INDUSTRIAL UPS CONFIGURATION PROGRAM ABILITIES

- Select one of five output voltages to match voltages found around the world.
- Enable/Disable Auto-Restart.
- Enable/Disable the Line-Neutral-Reversal/Loss-of-Ground receptacle wiring alarm.
- Select frequency converter operation with a fixed output frequency of 50 or 60 Hz.
- Set the Low Battery Warning alarm time from 2 to 30 minutes.
- Enable/Disable the Auto-Battery test.
- Set the Auto-Battery test to 7, 14, 21, or 28 days.
- Select the number of external battery cabinets connected to the UPS to adjust the remaining run time calculations reported by Sola/Hevi-Duty software.
- Modify the shutdown setting of DB-9 pin 6 (for information on pin assignments, see **Communications** on page 17).



### NOTE

*This program is compatible with UPS models beginning with "S4K2-", as in "S4K2U1500." It is not compatible with earlier versions of S4000 UPS.*

## What You Will Need

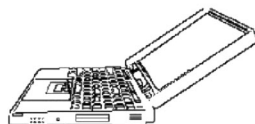
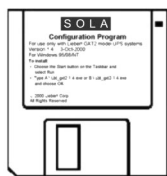
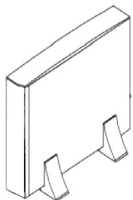

In addition to the S4K Industrial UPS, you will need the configuration program diskette and serial cable (Beige or Tan, 3-wire: GND, TX, RX; straight through 2-2, 3-3, 5-5) included in the UPS accessory box. The BLACK ML9P9S CONTACT CLOSURE communication cable IS NOT compatible with the configuration program. A Windows 95<sup>®</sup>, 98<sup>®</sup>, or NT<sup>®</sup> computer—desktop or laptop—is also required to set up and run the configuration program.

# MAINTENANCE

The S4K Industrial UPS requires very little maintenance. The batteries are valve-regulated, nonspillable, flame retardant, lead acid, and should be kept charged to obtain their designed life. The UPS continuously charges the batteries when connected to the utility supply.

When storing the UPS for any length of time, it is recommended to plug the UPS in for at least 24 hours every four to six months to ensure full recharge of the batteries.

The S4K Industrial UPS is designed to allow the user to safely replace the internal batteries. Read the safety cautions before proceeding. Contact your local distributor or Sola/Hevi-Duty representative to obtain the appropriate replacement battery kit part number and pricing.

## BATTERY REPLACEMENT



### CAUTION

**A battery can present a risk of electrical shock and high short circuit current. The following precautions should be observed before replacing the batteries:**

- **Remove rings, watches, or other metal objects.**
- **Use a Phillips (crosshead) screwdriver with insulated grips.**
- **Do not lay tools or other metal objects on top of the batteries.**
- **If the battery replacement kit is damaged in any way or shows signs of leakage, contact your local distributor or Sola/Hevi-Duty representative immediately.**
- **Do not dispose of batteries in a fire. The batteries may explode.**



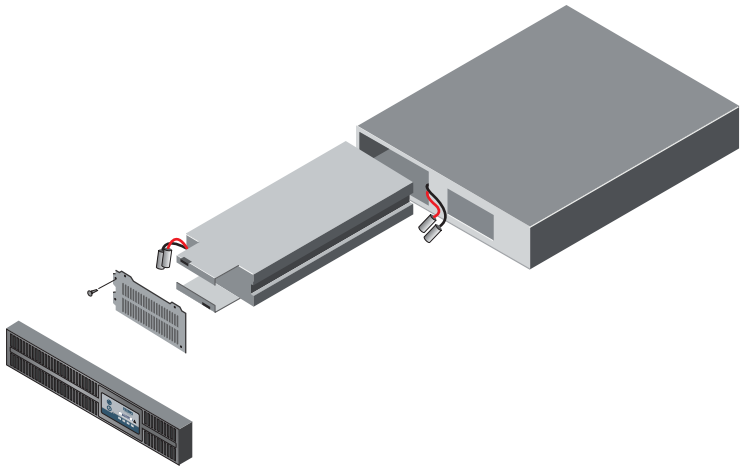

### Internal Battery Replacement Procedures

1. Gently remove the front plastic bezel cover from the UPS.
2. Loosen and remove the four screws on the front battery door. Lay the battery door aside for reassembly.
3. Gently pull battery wiring out and disconnect the two slotted battery connectors.
4. Grasp the battery pack assembly, and pull it out of the front of the UPS.
5. Unpack the new battery assembly taking care not to destroy the packing. Compare new and old battery assemblies to make sure they are the same. If so, proceed with **Step 6**; otherwise STOP and contact your local distributor, Sola/Hevi-Duty representative, or Sola/Hevi-Duty Technical Support Group.
6. Line up and slide in the new replacement battery pack.
7. Reconnect the 2 slotted battery connectors and gently push the battery wiring and battery pack assembly back into the UPS.
8. Reattach the front battery door with the four screws.
9. Reattach the front plastic bezel cover to the UPS.



#### NOTE

*These are hot-swappable replacement batteries. However, caution should be exercised because during this procedure the load is unprotected from disturbances and power outages.*

## FUSE REPLACEMENT



### CAUTION

**Before changing the input fuse, turn off the UPS, and unplug the supply lead from the AC input supply. Replace the fuse with the same type and rating.**

1. Remove the input fuse from the fuse holder on the rear of the unit.
2. Locate the spare input fuse that is shipped with the UPS.
3. Insert the spare fuse into the fuse holder, and reinstall assembly into the UPS. Twist by hand; rotate clockwise until fuse holder locks into position.
4. Reconnect the input power cord to input AC supply.
5. Restart the UPS. The UPS is ready for normal operation.

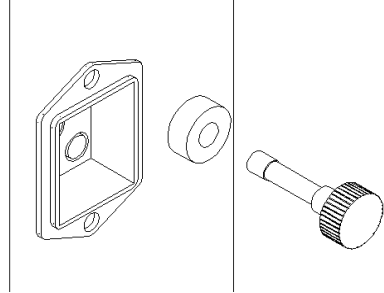

# TROUBLESHOOTING

The information below indicates various symptoms a user may encounter in the event the S4K Industrial UPS develops a problem. Use this information to determine whether external factors caused the problem and how to remedy the situation.

1. The Fault indicator will illuminate, indicating the UPS detected a problem.
2. An alarm will sound, alerting that the UPS requires attention.
3. One or more additional load/battery level LED indicators will be illuminated to provide a diagnostic aid to the operator, as described below:

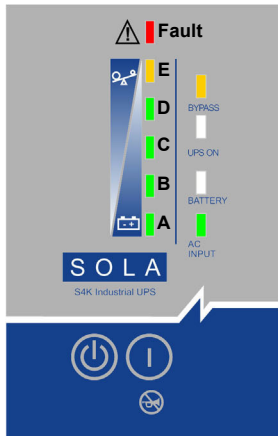

This example shows UPS on bypass due to output overload.

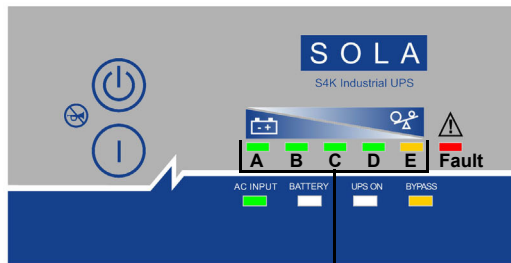

LOAD/BATTERY  
LEVEL INDICATORS

LED status	Diagnosis/Audible alarm
<b>All LEDs</b>	On bypass due to output overload; beep ever half-second
<b>A LED</b>	On bypass due to overtemperature condition; beep every 4 sec.
<b>B LED</b>	On bypass due to DC bus overvoltage; beep every 4 sec.
<b>C LED</b>	On bypass due to control power supply failure; beep every 4 sec.
<b>D LED</b>	On bypass due to PFC failure; beep every 4 sec.
<b>E LED</b>	On bypass due to inverter failure; beep every 4 sec.
<b>A&amp;C LEDs</b>	UPS failed battery test; long beep every minute
<b>C&amp;E LEDs</b>	UPS shutdown due to command from communication port (SNMP); no beep
<b>Battery LED Flashing</b>	Internal Battery source not available (continuous horn). Check battery connection, completely power down and reboot UPS.
<b>AC LED Flashing</b>	Line to neutral reversal in the AC input power supply or a loss of proper grounding; continuous horn and UPS will not start.
<b>Bypass LED Flashing</b>	Utility power voltage or frequency is out of tolerance; bypass is unavailable.

Under fault conditions, the Fault indicators will be illuminated indefinitely while battery charger is operational, or for a maximum of 5 minutes while battery charger is not operational.

If a problem persists, consult your local distributor, Sola/Hevi-Duty representative or contact Sola/Hevi-Duty Technical Support Group. Please have the UPS model number and serial number available at the time of your inquiry.

## Troubleshooting Guide

<b>Problem</b>	<b>Cause</b>	<b>Solution</b>
UPS fails to start when the ON button is pressed.	UPS is short circuited or overloaded.	Ensure UPS is OFF. Disconnect all loads and ensure nothing is lodged in output receptacles. Ensure loads are not defective or shorted internally.
Battery indicator LED is illuminated.	UPS not plugged in.	UPS is operating from battery mode, make certain UPS is securely plugged into the wall receptacle.
	UPS input protection fuse has blown/opened.	UPS is operating from battery mode. Save data and close applications. Replace UPS input fuse, then restart UPS.
	Utility voltage out of UPS input range.	UPS is operating from battery mode. Save data and close applications. Ensure utility supply voltage is within acceptable limits for UPS.
UPS has reduced battery time.	Batteries are not fully charged.	Keep UPS plugged in continuously at least 24 hours to recharge batteries.
	UPS is overloaded.	Check load level display and reduce the load on the UPS.
	Batteries may not be able to hold a full charge due to age.	Replace batteries. Contact your local distributor, Sola/Hevi-Duty representative or Sola/Hevi-Duty Technical Support Group for replacement battery kit.
Fault and Bypass indicator LEDs and all load level LEDs are illuminated.	UPS overloaded or load equipment is faulty.	Check load level display and remove non-essential loads. Recalculate the load and reduce number of loads connected to UPS. Check load equipment for faults.

## Troubleshooting Guide (Continued)

Problem	Cause	Solution
Fault and Bypass indicator LEDs and diagnostic LED A are illuminated.	UPS internal fan has a problem or UPS shutdown due to temperature condition. Load is on bypass power.	Ensure UPS is not overloaded, ventilation openings not blocked, or room ambient temperature is not excessive. Wait 30 minutes to allow UPS to cool, then restart UPS. IF UPS does not restart, contact your local distributor, Sola/Hevi-Duty representative or Sola/Hevi-Duty Technical Support Group.
Fault and Bypass indicator LEDs and diagnostic LED B are illuminated.	UPS internal DC bus overvoltage.	UPS requires service. Contact your local distributor, Sola/Hevi-Duty representative or Sola/Hevi-Duty Technical Support Group.
Fault and Bypass indicator LEDs and diagnostic LED C are illuminated.	UPS control power supply fault.	UPS requires service. Contact your local distributor, Sola/Hevi-Duty representative or Sola/Hevi-Duty Technical Support Group.
Fault and Bypass indicator LEDs and diagnostic LED D are illuminated.	UPS PFC (Power Factor Correction Circuit) fault.	UPS requires service. Contact your local distributor, Sola/Hevi-Duty representative or Sola/Hevi-Duty Technical Support Group.
Fault and Bypass indicator LEDs and diagnostic LED E are illuminated.	UPS inverter fault.	UPS requires service. Contact your local distributor, Sola/Hevi-Duty representative or Sola/Hevi-Duty Technical Support Group.
Fault and Bypass indicator LEDs and diagnostic LED A and C are illuminated.	UPS failed the battery test.	Replace batteries. Contact your local distributor, Sola/Hevi-Duty representative or Sola/Hevi-Duty Technical Support Group.
Fault and Bypass indicator LEDs and diagnostic LED C and E are illuminated.	UPS shutdown due to a command from the communications port(s).	Your UPS has received a signal or command from the attached computer. If this was inadvertent, ensure the communication cable used is correct for your system. For assistance, contact your Sola/Hevi-Duty representative or Sola/Hevi-Duty Technical Support Group.

## Troubleshooting Guide (Continued)

Problem	Cause	Solution
AC LED is flashing.	UPS detected a line-to-neutral reversal or a loss of proper grounding; continuous horn and UPS will not start. This is active only when power is first applied to the input. Once the UPS is running, the AC LED will not start flashing, even if the input wiring is changed.	Contact a qualified electrician to verify site wiring.
Battery LED is flashing.	Battery source is not available; continuous horn.	Check battery connections, completely power down and restart UPS. NOTE: If the battery circuit opens while the UPS is running, it will be detected when the next battery test is performed.
Bypass LED is flashing.	Bypass voltage is present, but is disabled for use because the voltage or frequency is outside acceptable limits.	The AC input powers the PFC input and serves as the bypass source. If the AC is present but the voltage or frequency exceeds the acceptable range for safe operation with a load, the bypass will be disabled and this LED will flash, indicating that the bypass is unavailable.

## **Alarm Conditions**

<b>Condition</b>	<b>Alarm</b>
Battery Mode (utility failure)	One short beep every 10 seconds; more than 2 minutes of run time remaining
Low Battery	Two short beeps every 5 seconds; less than 2 minutes of run time remaining
Output overload (bypass)	One short beep every half second
Overtemperature (bypass)	A one-second beep every 4 seconds
DC Bus Overvoltage (bypass)	A one-second beep every 4 seconds
Control power supply failure (bypass)	A one-second beep every 4 seconds
PFC failure (bypass)	A one-second beep every 4 seconds
Inverter failure	A one-second beep every 4 seconds
Battery Test failure	A 2-second beep every minute

# SPECIFICATIONS

Model Number	S4K2U700	S4K2U1000	S4K2U1500
Model Rating	700VA / 490W	1000VA / 700W	1500VA / 1050W
<b>DIMENSIONS in (mm)</b>			
Unit W x D x H in. (mm)	3.5 x 21.5 x 17 (87 x 547 x 430)	3.5 x 21.5 x 17 (87 x 547 x 430)	3.5 x 21.5 x 17 (87 x 547 x 430)
Shipping W x D x H in. (mm)	10.4 x 27.3 x 22.5 (268 x 692 x 585)	10.4 x 27.3 x 22.5 (268 x 692 x 585)	10.4 x 27.3 x 22.5 (268 x 692 x 585)
<b>WEIGHT lbs (kg)</b>			
Unit	48.9 (22.2)	49.1 (22.3)	50.6 (23)
Shipping	57.7 (26.2)	57.9 (26.3)	59.5 (27)
<b>INPUT AC PARAMETERS</b>			
Voltage Range (typical)	120 VAC nominal; variable based on output load		
100% - 90% loading	80 VAC / 140 VAC	80 VAC / 140 VAC	90 VAC / 140 VAC
90% -70% loading	80 VAC / 140 VAC	80 VAC / 140 VAC	80 VAC / 140 VAC
70% -30% loading	70 VAC / 140 VAC	70 VAC / 140 VAC	70 VAC / 140 VAC
30% - 0% loading	60 VAC / 140 VAC	60 VAC / 140 VAC	60 VAC / 140 VAC
Frequency	40 - 70 Hz; Auto Sensing		
Input Power Cord	6 ft. attached w/ NEMA 5-15 plug	10 ft. attached w/ NEMA 5-15 plug	10 ft. attached w/ NEMA 5-15 plug
<b>OUTPUT AC PARAMETERS</b>			
Output Receptacles	(4) NEMA 5-15R		
Voltage	100/110/115/120/127 (user configurable) VAC; ±3%		
Frequency	50 Hz or 60 Hz		
Waveform	Sinewave		
Main Mode Overload	200% for 8 cycles; 130% for 10 seconds with transfer to bypass		
<b>BATTERY PARAMETERS</b>			
Type	Valve-regulated, nonspillable, flame retardant, lead acid		
Qty x V x Rating	4 x 12V x 7.0 or 7.2 AH		
Battery Mfg / Part #	China Storage Battery / CSB FR 1270 F2		
Back-up Time	See <b>Battery Run Times</b> charts		
Recharge Time	5 Hours to 95% capacity after full discharge into 100% load		
<b>ENVIRONMENTAL</b>			
Operating Temp	+32°F to +104°F (0°C to +40°C)		
Storage Temp	+5°F to +122°F (-15°C to +50°C)		
Relative Humidity	0% to 95%, non-condensing		
Operating Elevation	Up to 10,000 ft. (3000m) at 104°F (40°C) without derating		
Storage Elevation	50,000 ft. (15,000m) maximum		
Audible Noise	<50 dBA, at 1 meter from the rear <45 dBA, at 1 meter from the front or sides		
<b>AGENCY</b>			
Safety	UL 1778, c-UL Listed (Suitable for computer room applications)		
RFI/EMI	FCC Part 15, Subpart B, Class A		
Surge Immunity	IEEE/ANSI C62.41 Category A & B		
Transportation	ISTA Procedure 1A		



## Specifications (Continued)

Model Number	S4K2U2000	S4K2U3000
Model Rating	2000VA / 1400W	3000VA / 2100W
<b>DIMENSIONS in (mm)</b>		
Unit	3.5 x 21.5 x 17	3.5 x 24.2 x 17
W x D x H in. (mm)	(87 x 547 x 430)	(87 x 618 x 430)
Shipping	10.5 x 27.2 x 23	10.5 x 27.2 x 23
W x D x H in. (mm)	(268 x 692 x 585)	(268 x 692 x 585)
<b>WEIGHT lbs (kg)</b>		
Unit	54 (24)	69 (31)
Shipping	62.6 (28.4)	78.0 (35.4)
<b>INPUT AC PARAMETERS</b>		
Voltage Range (typical)	120 VAC nominal; variable based on output load	
100% - 90% loading	90 VAC / 140 VAC	90 VAC / 140 VAC
90% -70% loading	80 VAC / 140 VAC	80 VAC / 140 VAC
70% -30% loading	70 VAC / 140 VAC	70 VAC / 140 VAC
30% - 0% loading	60 VAC / 140 VAC	60 VAC / 140 VAC
Frequency	40 - 70 Hz; Auto Sensing	
Input Power Cord	10 ft. attached w/ NEMA 5-20 plug	10 ft. attached w/ NEMA L5-30 plug
<b>OUTPUT AC PARAMETERS</b>		
Output Receptacles	(4) 5-20R T-Slot, accepts 15A plug	(4) NEMA 5-15R (1) NEMA L5-30R on 12 in cord
Voltage	100/110/115/120/127 (user configurable) VAC; ±3%	
Frequency	50 Hz or 60 Hz	
Waveform	Sinewave	
Main Mode Overload	200% for 8 cycles; 130% for 10 seconds with transfer to bypass	
<b>BATTERY PARAMETERS</b>		
Type	Valve-regulated, nonspillable, flame retardant, lead acid	
Qty x V x Rating	4 x 12V x 9.0 AH	6 x 12V x 9.0 AH
Battery Mfg / Part #	Panasonic / UP-VW1245P1 Yuasa / REW 45-12 FR	
Back-up Time	See <b>Battery Run Times</b> charts	
Recharge Time	5 hours to 95% capacity after full discharge into 100% load	
<b>ENVIRONMENTAL</b>		
Operating Temp	+32°F to +104°F (0°C to +40°C)	
Storage Temp	+5°F to +122°F (-15°C to +50°C)	
Relative Humidity	0% to 95%, non-condensing	
Operating Elevation	Up to 10,000 ft. (3000m) at 104°F (40°C) without derating	
Storage Elevation	50,000 ft. (15,000 m) maximum	
Audible Noise	<55 dBA, at 1 meter from the rear <50 dBA, at 1 meter from the front or sides	
<b>AGENCY</b>		
Safety	UL 1778, c-UL Listed (Suitable for computer room applications)	
RFI/EMI	FCC Part 15, Subpart B, Class A	
Surge Immunity	IEEE/ANSI C62.41 Category A & B	
Transportation	ISTA Procedure 1A	

# BATTERY CABINET SPECIFICATIONS

Model Number	S4K2U48BAT	S4K2U96BAT
Used w/ UPS Model	S4K2U700 S4K2U1000 S4K2U1500 S4K2U2000	S4K2U3000
<b>DIMENSIONS in (mm)</b>		
Unit W x D x H	3.5 x 21.5 x 17 (87 x 547 x 430)	3.5 x 24.2 x 17 (87 x 618 x 430)
Shipping W x D x H	10.5 x 27.2 x 23 (268 x 692 x 585)	10.5 x 27.2 x 23 (268 x 692 x 585)
<b>WEIGHT lbs (kg)</b>		
Unit	65.0 (29.5)	93.6 (42.5)
Shipping	71.1 (32.3)	102.5 (46.5)
<b>BATTERY PARAMETERS</b>		
Type	Valve-regulated, nonspillable, flame retardant, lead acid	
Qty x V x Rating	2 x 4 x 12V x 7.0 or 7.2 AH	2 x 6 x 12V x 9.0 AH
Battery Mfg / Part #	China Storage Battery / CSBFR 1270 F2	Panasonic / UP-VW1245P1 Yuasa / REW 45-12 FR
Back-up Time	See <b>Battery Run Times</b> charts	
<b>ENVIRONMENTAL</b>		
Operating Temp	+32°F to +104°F (0°C to +40°C)	
Storage Temp	+5°F to +122°F (-15°C to +50°C)	
Relative Humidity	0% to 95%, non-condensing	
Operating Elevation	Up to 10,000 ft. (3000m) at 104°F (40°C) without derating	
Storage Elevation	50,000 ft. (15,000 m) maximum	
<b>AGENCY</b>		
Safety	UL 1778, c-UL Listed (Suitable for computer room applications)	
RFI/EMI	FCC Part 15, Subpart B, Class A	
Transportation	ISTA Procedure 1A	

# BATTERY RUN TIMES

	Load%	700VA	1000VA	1500VA	2000VA	3000VA
<b>Internal Battery (minutes)</b>	10%	248	191	144	56	91
	20%	115	87	53	33	46
	30%	79	48	38	26	30
	40%	58	34	28	19	21
	50%	44	25	20	14	16
	60%	35	19	15	12	11
	70%	29	16	12	10	9
	80%	24	13	10	8	8
	90%	20	12	8	7	7
	100%	17	11	7	6	5
<b>Internal Battery + 1 External Battery Cabinet (minutes)</b>	10%	992	764	576	168	364
	20%	460	348	212	99	184
	30%	316	192	152	78	120
	40%	232	136	112	57	84
	50%	176	100	80	42	64
	60%	140	76	60	36	44
	70%	116	64	48	30	36
	80%	96	52	40	24	32
	90%	80	48	32	21	28
	100%	68	44	28	18	20
<b>Internal Battery + 2 External Battery Cabinets (minutes)</b>	10%	1984	1528	1152	392	728
	20%	920	696	424	231	368
	30%	632	384	304	182	240
	40%	464	272	224	133	168
	50%	352	200	160	98	128
	60%	280	152	120	84	88
	70%	232	128	96	70	72
	80%	192	104	80	56	64
	90%	160	96	64	49	56
	100%	136	88	56	42	40
<b>Internal Battery + 3 External Battery Cabinets (minutes)</b>	10%	2976	2292	1728	560	1092
	20%	1380	1044	636	330	552
	30%	948	576	456	260	360
	40%	696	408	336	190	252
	50%	528	300	240	140	192
	60%	420	228	180	120	132
	70%	348	192	144	100	108
	80%	288	156	120	80	96
	90%	240	144	96	70	84
	100%	204	132	84	60	60
<b>Internal Battery + 4 External Battery Cabinets (minutes)</b>	10%	3968	3056	2304	840	1456
	20%	1840	1392	848	495	736
	30%	1264	768	608	390	480
	40%	928	544	448	285	336
	50%	704	400	320	210	256
	60%	560	304	240	180	176
	70%	464	256	192	150	144
	80%	384	208	160	120	128
	90%	320	192	128	105	112
	100%	272	176	112	90	80

Approximate discharge times are in minutes and at 77°F (25°C) and with a 100% resistive load.







**SOLA/  
HEVI-DUTY**

---

## **Technical Support**

U.S.A. . . . . (800) 377-4384

International . . . . . (847) 679-7800

**[www.solaheviduty.com](http://www.solaheviduty.com)**

While every precaution has been taken to ensure accuracy and completeness in this manual, Sola/Hevi-Duty assumes no responsibility, and disclaims all liability for damages resulting from use of this information or for any errors or omissions.

© 2002 Sola/Hevi-Duty. All rights reserved throughout the world.

Specifications subject to change without notice.

® Sola/Hevi-Duty name and logo are registered trademarks of EGS Electrical Group, LLC.

Names referred to are trademarks or registered trademarks of their respective owners.

Rev. 04152002 MJ/RP