



STD1805

LOW VOLTAGE FAST-SWITCHING NPN POWER TRANSISTOR

PRELIMINARY DATA

Ordering Code	Marking	Shipment
STD1805T4	D1805	Tape & Reel
STD1805-1	D1805	Tube

- VERY LOW COLLECTOR TO EMITTER SATURATION VOLTAGE
- HIGH CURRENT GAIN CHARACTERISTIC
- FAST-SWITCHING SPEED
- THROUGH-HOLE IPAK (TO-251) POWER PACKAGE IN TUBE (Suffix "-1")
- SURFACE-MOUNTING DPAK (TO-252) POWER PACKAGE IN TAPE & REEL (Suffix "T4")

APPLICATIONS:

- CCFL DRIVERS
- VOLTAGE REGULATORS
- RELAY DRIVERS
- HIGH EFFICIENCY LOW VOLTAGE SWITCHING APPLICATIONS

DESCRIPTION

The device is manufactured in NPN Planar Technology by using a "Base Island" layout. The resulting Transistor shows exceptional high gain performance coupled with very low saturation voltage.

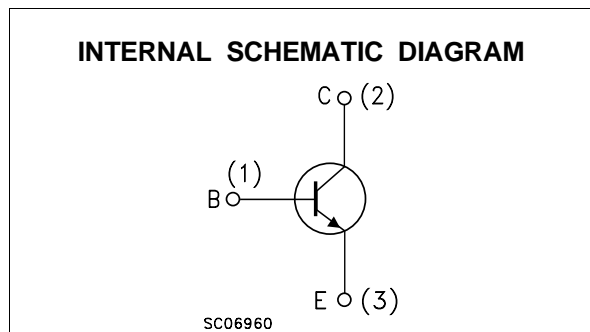
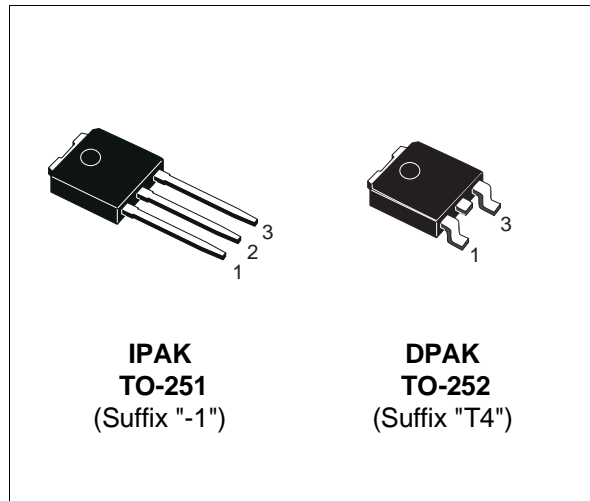

ABSOLUTE MAXIMUM RATINGS

Symbol	Parameter	Value	Unit
V_{CBO}	Collector-Base Voltage ($I_E = 0$)	150	V
V_{CEO}	Collector-Emitter Voltage ($I_B = 0$)	60	V
V_{EBO}	Emitter-Base Voltage ($I_C = 0$)	7	V
I_C	Collector Current	5	A
I_{CM}	Collector Peak Current ($t_p < 5$ ms)	10	A
I_B	Base Current	2	A
P_{tot}	Total Dissipation at $T_c = 25$ °C	15	W
T_{stg}	Storage Temperature	-65 to 150	°C
T_j	Max. Operating Junction Temperature	150	°C

STD1805

THERMAL DATA

R _{thj-case}	Thermal Resistance Junction-case	Max	8.33	°C/W
-----------------------	----------------------------------	-----	------	------

ELECTRICAL CHARACTERISTICS (T_{case} = 25 °C unless otherwise specified)

Symbol	Parameter	Test Conditions		Min.	Typ.	Max.	Unit
I _{CBO}	Collector Cut-off Current (I _E = 0)	V _{CB} = 40 V				0.1	μA
I _{EBO}	Emitter Cut-off Current (I _C = 0)	V _{EB} = 4 V				0.1	μA
V _{(BR)CBO}	Collector-Base Breakdown Voltage (I _E = 0)	I _C = 100 μA		150			V
V _{(BR)CEO*}	Collector-Emitter Breakdown Voltage (I _B = 0)	I _C = 1 mA		60			V
V _{(BR)EBO}	Emitter-Base Breakdown Voltage (I _C = 0)	I _E = 100 μA		7			V
V _{CE(sat)*}	Collector-Emitter Saturation Voltage	I _C = 100 mA I _C = 2 A I _C = 3 A I _C = 5 A	I _B = 5 mA I _B = 50 mA I _B = 150 mA I _B = 200 mA		150 200	50 300 400 600	mV mV mV mV
V _{BE(sat)*}	Base-Emitter Saturation Voltage	I _C = 2 A	I _B = 100 mA		0.9	1.2	V
h _{FE*}	DC Current Gain	I _C = 100 mA I _C = 5 A I _C = 10 A	V _{CE} = 2 V V _{CE} = 2 V V _{CE} = 2 V	200 85 20		400	
f _T	Transition frequency	V _{CE} = 10 V	I _C = 50 mA		150		MHz
C _{CBO}	Collector-Base Capacitance	V _{CB} = 10 V	f = 1 MHz		50		pF
t _{ON} t _s t _f	RESISTIVE LOAD Turn- on Time Storage Time Fall Time	I _C = 1 A I _{B1} = - I _{B2} = 0.1 A	V _{CC} = 30 V		50 1.35 120		ns μs ns

* Pulsed: Pulse duration = 300μs, duty cycle = 1.5 %

Derating Curve



DC Current Gain

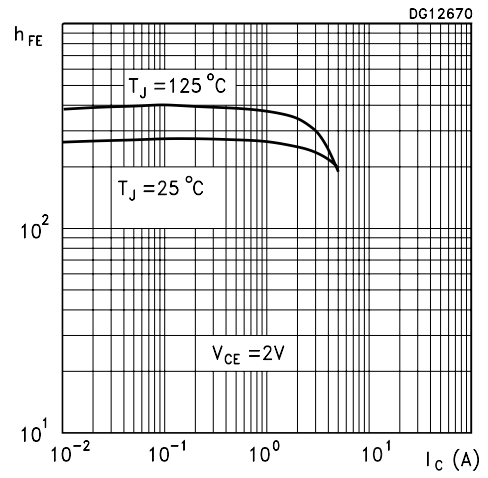

Collector-Emitter Saturation Voltage

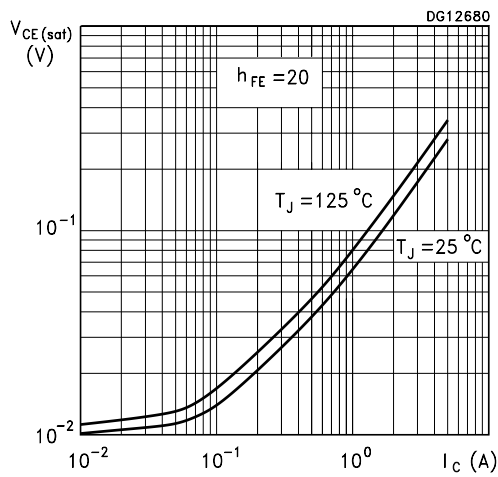

Collector-Emitter Saturation Voltage

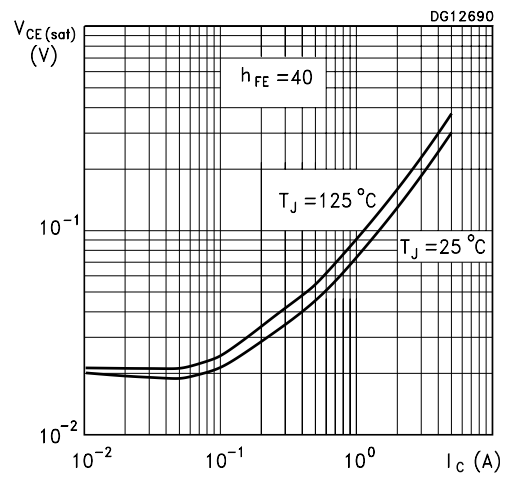

Base-Emitter Saturation Voltage

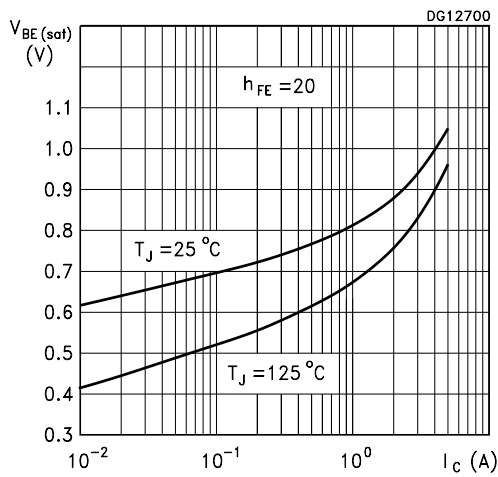

Base-Emitter On Voltage

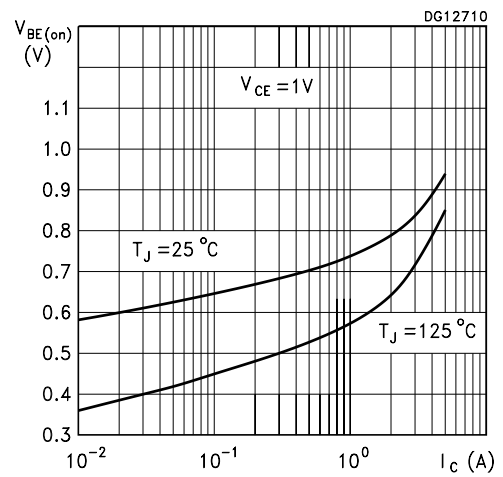

Switching Times Resistive Load

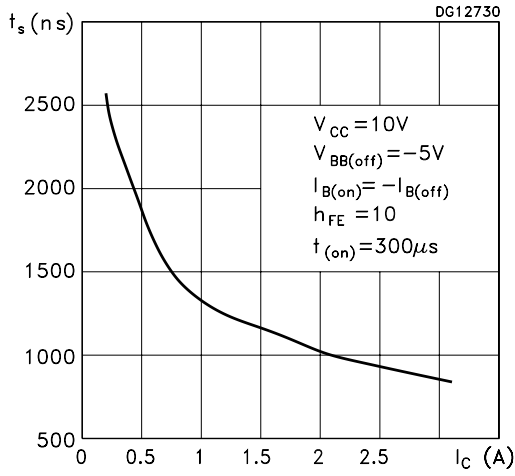

Switching Times Resistive Load

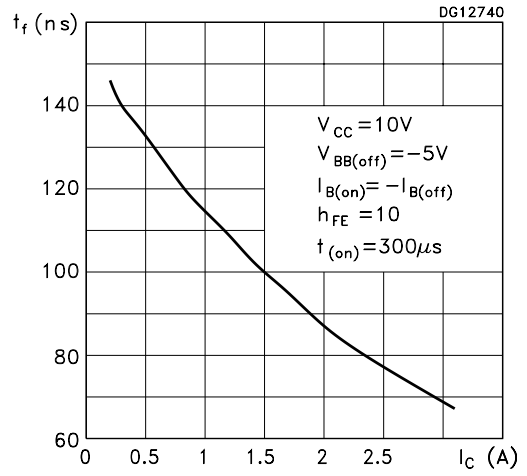

Switching Times Resistive Load

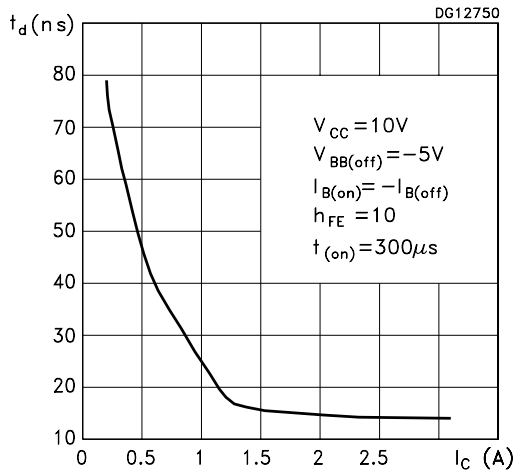

Switching Times Inductive Load

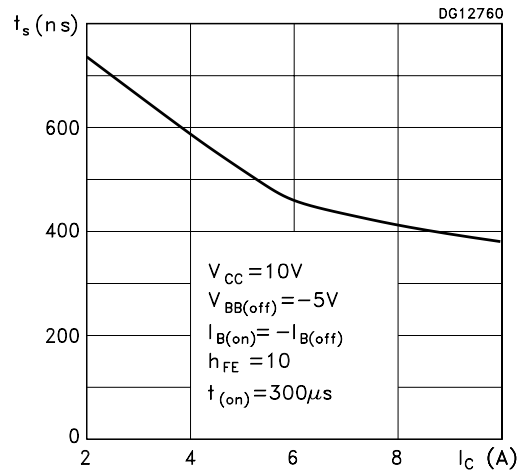

Switching Times Inductive Load

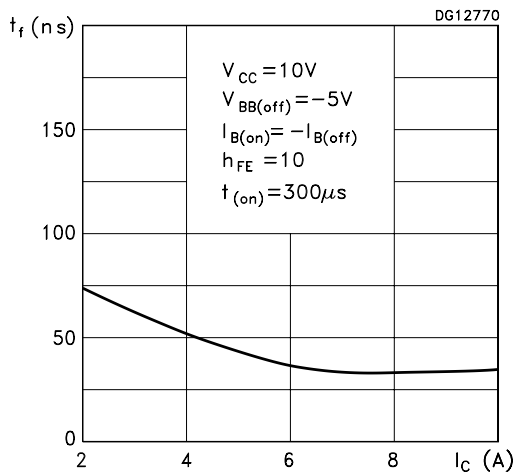
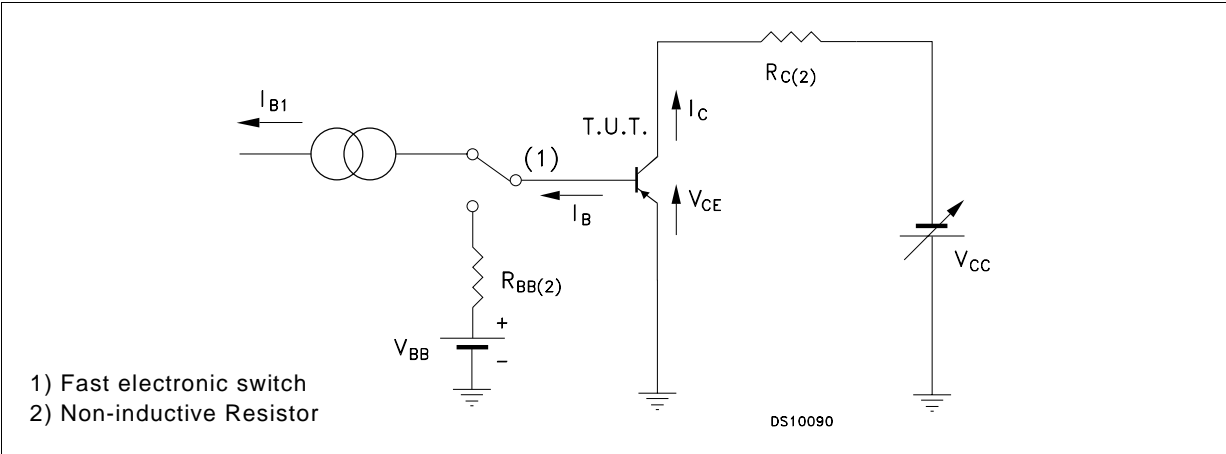
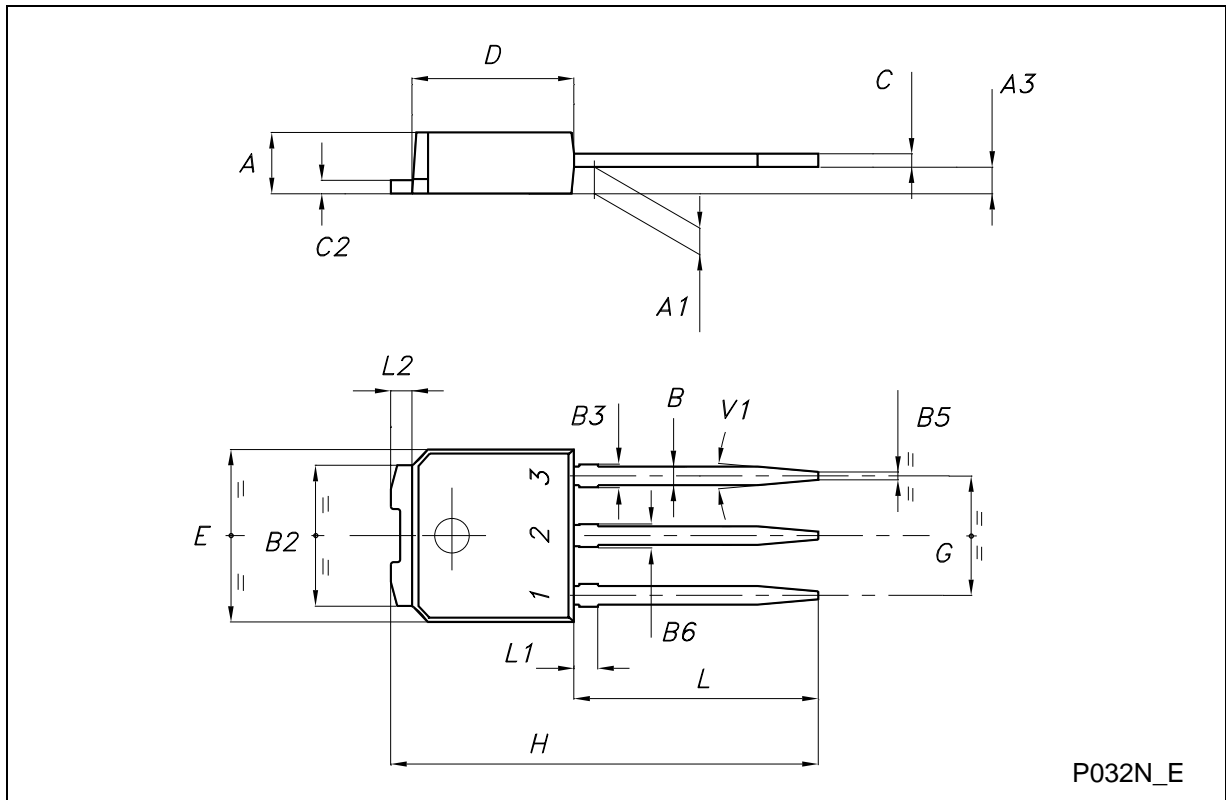

Figure 1: Resistive Load Switching Test Circuit.



TO-251 (IPAK) MECHANICAL DATA

DIM.	mm			inch		
	MIN.	TYP.	MAX.	MIN.	TYP.	MAX.
A	2.20		2.40	0.087		0.094
A1	0.90		1.10	0.035		0.043
A3	0.70		1.30	0.028		0.051
B	0.64		0.90	0.025		0.035
B2	5.20		5.40	0.204		0.213
B3			0.85			0.033
B5		0.30			0.012	
B6			0.95			0.037
C	0.45		0.60	0.018		0.024
C2	0.48		0.60	0.019		0.024
D	6.00		6.20	0.237		0.244
E	6.40		6.60	0.252		0.260
G	4.40		4.60	0.173		0.181
H	15.90		16.30	0.626		0.642
L	9.00		9.40	0.354		0.370
L1	0.80		1.20	0.031		0.047
L2		0.80	1.00		0.031	0.039
V1		10°			10°	



P032N_E

TO-252 (DPAK) MECHANICAL DATA

DIM.	mm			inch		
	MIN.	TYP.	MAX.	MIN.	TYP.	MAX.
A	2.20		2.40	0.087		0.094
A1	0.90		1.10	0.035		0.043
A2	0.03		0.23	0.001		0.009
B	0.64		0.90	0.025		0.035
B2	5.20		5.40	0.204		0.213
C	0.45		0.60	0.018		0.024
C2	0.48		0.60	0.019		0.024
D	6.00		6.20	0.236		0.244
E	6.40		6.60	0.252		0.260
G	4.40		4.60	0.173		0.181
H	9.35		10.10	0.368		0.398
L2		0.8			0.031	
L4	0.60		1.00	0.024		0.039
V2	0°		8°	0°		0°

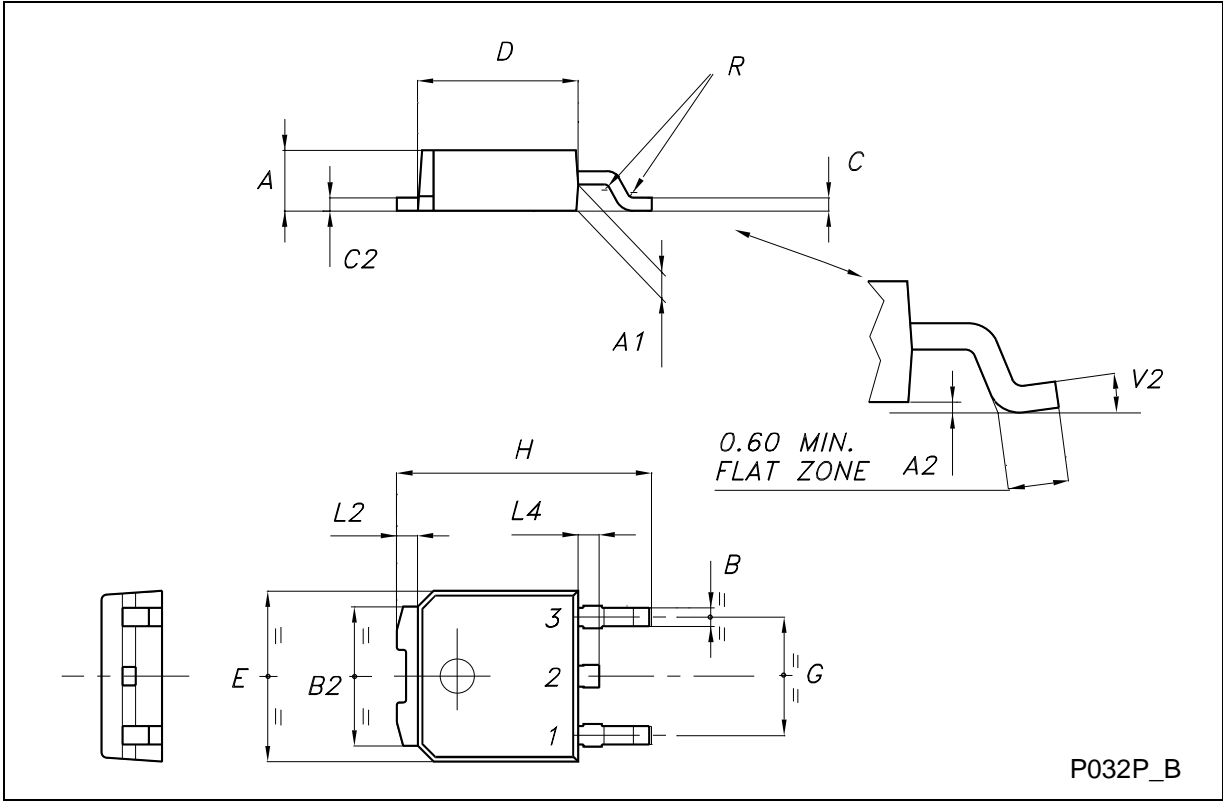

Information furnished is believed to be accurate and reliable. However, STMicroelectronics assumes no responsibility for the consequences of use of such information nor for any infringement of patents or other rights of third parties which may result from its use. No license is granted by implication or otherwise under any patent or patent rights of STMicroelectronics. Specification mentioned in this publication are subject to change without notice. This publication supersedes and replaces all information previously supplied. STMicroelectronics products are not authorized for use as critical components in life support devices or systems without express written approval of STMicroelectronics.

The ST logo is a trademark of STMicroelectronics.

All other names are the property of their respective owners.

© 2003 STMicroelectronics – All Rights reserved

STMicroelectronics GROUP OF COMPANIES

Australia - Belgium - Brazil - Canada - China - Czech Republic - Finland - France - Germany - Hong Kong - India - Israel - Italy - Japan - Malaysia - Malta - Morocco - Singapore - Spain - Sweden - Switzerland - United Kingdom - United States.

<http://www.st.com>