

Hi-Q® High RF Power Ribbon Leded MLC Capacitors

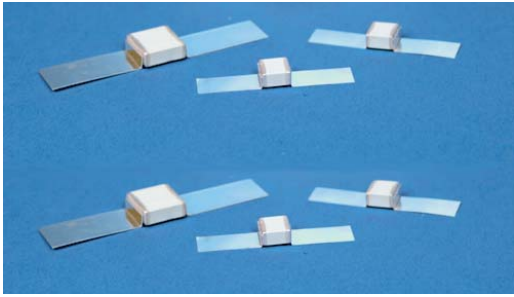

Hi-Q®, High RF Power, Ribbon Leded MLC Capacitors from AVX Corporation are characterized with ultra-low ESR and dissipation factor at high frequencies. The HQL-style parts are constructed using non-magnetic materials. They are designed to handle high power and high voltage levels for applications in RF power amplifiers, inductive heating, high magnetic field environments (MRI coils), medical and industrial electronics.

HOW TO ORDER

HQLC	A	A	271	J	A	A
AVX Style HQLC HQLE	Voltage 600V/630 = C 1000V = A 1500V = S 2000V = G 2500V = W 3000V = H 4000V = J 5000V = K 7200V = M	Temperature Coefficient COG = A	Capacitance Code (2 significant digits + no. of zeros) Examples: 4.7 pF = 4R7 10 pF = 100 100 pF = 101 1,000 pF = 102	Capacitance Tolerance C = ±0.25pF (<13pF) D = ±0.50pF (<25pF) F = ±1% (≥25pF) G = ±2% (≥13pF) J = ±5% K = ±10% M = ±20%	Test Level A = Standard	Lead Style A = Axial Ribbon M = Microstrip

Capacitance Range (pF)

Style	600/630 WVDC min./max.	1000 WVDC min./max.	1500 WVDC min./max.	2000 WVDC min./max.	2500 WVDC min./max.	3000 WVDC min./max.	4000 WVDC min./max.	5000 WVDC min./max.	7200 WVDC min./max.
HQLC	2200 - 2700	1500 - 1800	820 - 1200	470 - 680	330 - 390	3.3 - 270	3.3 - 6.8		
HQLE	3.3 - 6800	3.3 - 4700	3.3 - 2700	3.3 - 1800	3.3 - 1000	3.3 - 680	3.3 - 390	3.3 - 180	3.3 - 100

DIELECTRIC PERFORMANCE CHARACTERISTICS

Capacitance Range	3.3pF to 6,800pF (25°C, 1.0 ±0.2 Vrms at 1kHz, for ≤ 1000pF use 1MHz)
Capacitance Tolerances	±0.25pF, ±0.50pF, ±1%, ±2%, ±5%, ±10%, ±20%
Dissipation Factor	0.1% Max (+25°C, 1.0 ±0.2 Vrms at 1kHz, for ≤ 1000pF use 1MHz)
Operating Temperature Range	-55°C to +125°C
Temperature Characteristics	COG: 0 ± 30 ppm/°C (-55°C to +125°C)
Voltage Ratings	600, 630, 1000, 1500, 2000, 2500, 3000, 4000, 5000, 7200VDC
Insulation Resistance	100K MΩ min. @ +25°C and 500VDC 10K MΩ min. @ +125°C and 500VDC
Dielectric Strength	Minimum 120% of rated WVDC

Hi-Q[®] High RF Power Ribbon Ledged MLC Capacitors



Microstrip Leads (Lead Style "M")

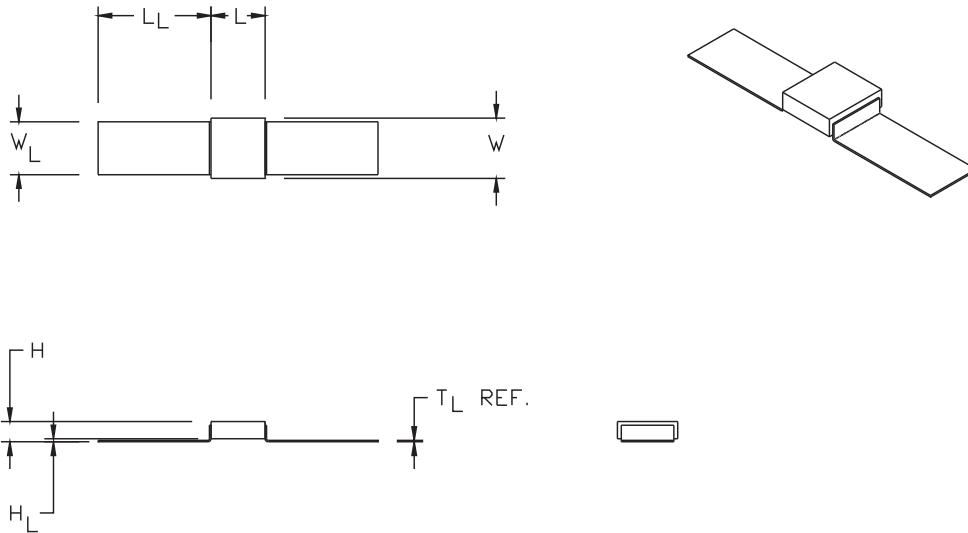

DIMENSIONS millimeters (inches)							
Unit Size	L ±0.51 (0.020)	L _L Min.	W ±0.64 (0.025)	W _L ±0.38 (0.015)	H ±0.64 (0.025)	H _L ±0.38 (0.015)	T _L Ref.
HQLC	5.72 (0.225)	12.7 (0.500)	6.35 (0.250)	6.10 (0.240)	3.68 (0.145)	0.64 (0.025)	0.10 (0.004)
HQLE	9.40 (0.370)	19.1 (0.750)	10.2 (0.400)	8.89 (0.350)	3.68 (0.145)	0.64 (0.025)	0.25 (0.010)

Note: Side to side lead alignment shall be within ±0.25 (0.010)

Axial Ribbon Leads (Lead Style "A")

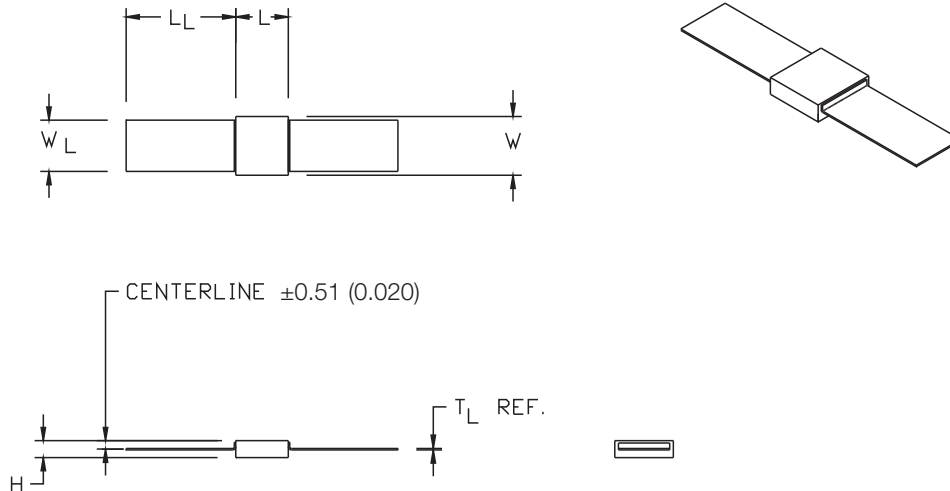

DIMENSIONS millimeters (inches)						
Unit Size	L ±0.51 (0.020)	L _L Min.	W ±0.64 (0.025)	W _L ±0.38 (0.015)	H ±0.64 (0.025)	T _L Ref.
HQLC	5.72 (0.225)	12.7 (0.500)	6.35 (0.250)	6.10 (0.240)	3.18 (0.125)	0.10 (0.004)
HQLE	9.40 (0.370)	19.1 (0.750)	10.2 (0.400)	8.89 (0.350)	3.18 (0.125)	0.25 (0.010)

Note: Side to side lead alignment shall be within ±0.25 (0.010)

Hi-Q[®] High RF Power MLC Capacitors



PERFORMANCE CHARACTERISTICS

Typical Series Resonant Frequency vs. Capacitance
HQCC and HQLC

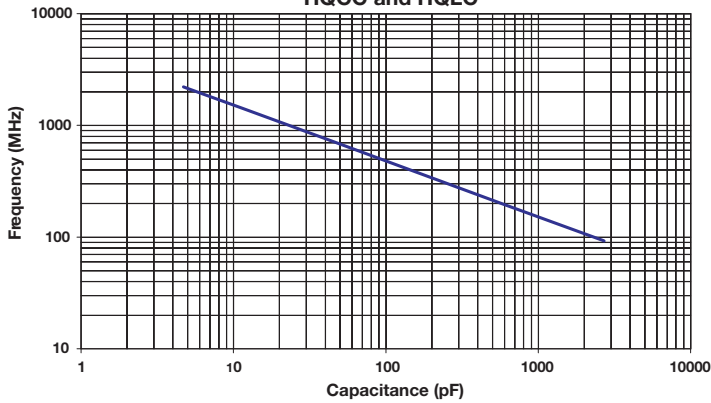

Typical ESR vs. Capacitance
HQCC and HQLC

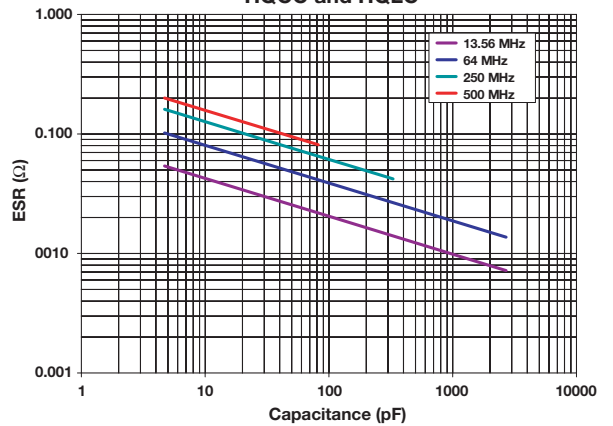

Typical Quality Factor vs. Capacitance
HQCC and HQLC

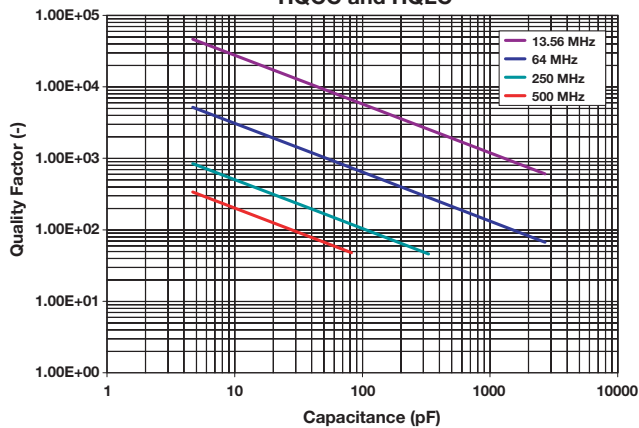

Maximum RMS Current vs. Capacitance
HQCC and HQLC

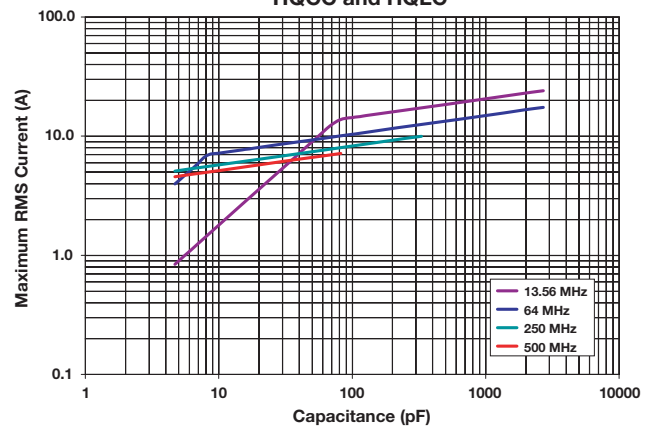

Hi-Q® High RF Power MLC Capacitors



PERFORMANCE CHARACTERISTICS

Typical Series Resonant Frequency vs. Capacitance
HQCE and HQLE

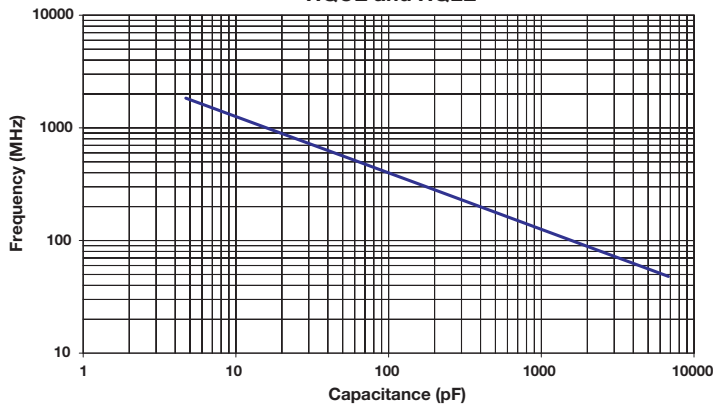

Typical ESR vs. Capacitance
HQCE and HQLE

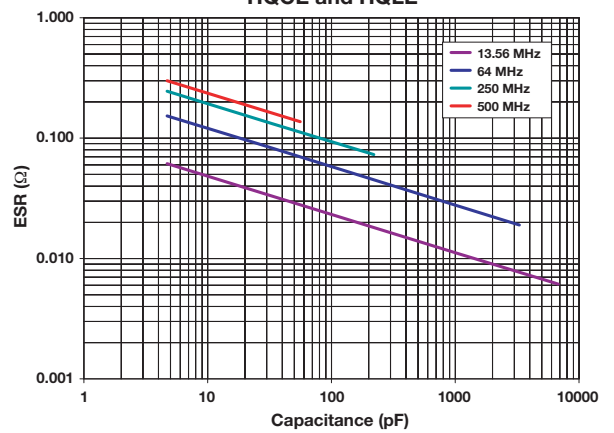

Typical Quality Factor vs. Capacitance
HQCE and HQLE

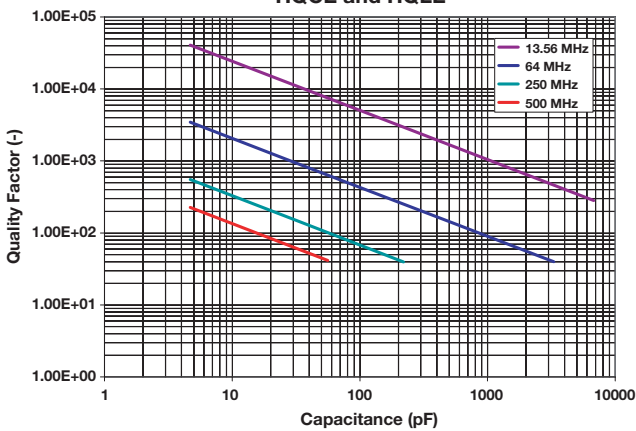

Maximum RMS Current vs. Capacitance
HQCE and HQLE

