

1.4 EPIC® H - B E

Einsätze / Inserts / Inserts

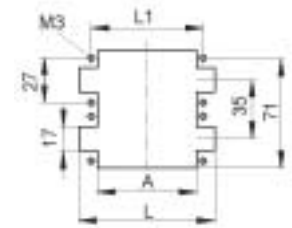
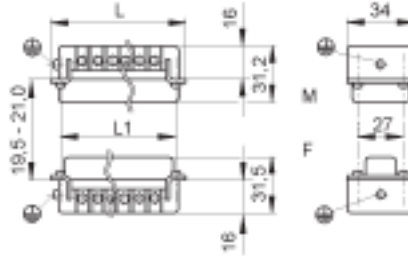

Montageausschnitt
Panel cut-out
Découpe de montage

Schraubanschluss / Screw termination / Raccord à visser

H-BE 24

Artikel part article	Version version version	Art.Nr. part No. N° art.	Drahtschutz wire protection protection de fil	Kontakte contacts contacts	L	L1	A
H-BE 24 SS	Stift / male / mâle	10196000	●	24	111	104	98
H-BE 24 BS	Buchse / female / femelle	10197000	●	24	111	104	98
H-BE 24 SS	Stift / male / mâle	10196100		24	111	104	98
H-BE 24 BS	Buchse / female / femelle	10197100		24	111	104	98

Gehäuse / Housings / Boîtiers: 3.2: H-B 24
Montageausschnitt siehe vorherige Seite / Panel cut out see previous page / Découpe de montage voir page précédente

Ansicht anschlussseitig
View from cable side
Vue côté raccordement



H-BE 32

Artikel part article	Version version version	Art.Nr. part No. N° art.	Drahtschutz wire protection protection de fil	Kontakte contacts contacts	L	L1	A
H-BE 16 SS 1-16	Stift / male / mâle	10194000	●	32	84,5	77,5	7
H-BE 16 SS 17-32		10202000	●		84,5	77,5	71
H-BE 16 BS 1-16	Buchse / female / femelle	10195000	●	32	84,5	77,5	71
H-BE 16 BS 17-32		10203000	●		84,5	77,5	71
H-BE 16 SS 1-16	Stift / male / mâle	10194100		32	84,5	77,5	71
H-BE 16 SS 17-32		10202100			84,5	77,5	71
H-BE 16 BS 1-16	Buchse / female / femelle	10195100		32	84,5	77,5	71
H-BE 16 BS 17-32		10203100			84,5	77,5	71

Gehäuse / Housings / Boîtiers:
3.2: H-B 32

Ansicht anschlussseitig
View from cable side
Vue côté raccordement

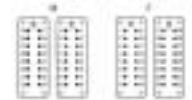

H-BE 48

Artikel part article	Version version version	Art.Nr. part No. N° art.	Drahtschutz wire protection protection de fil	Kontakte contacts contacts	L	L1	A
H-BE 24 SS 1-24	Stift / male / mâle	10196000	●	48	111	104	98
H-BE 24 SS 25-48		10204000	●		111	104	98
H-BE 24 BS 1-24	Buchse / female / femelle	10197000	●	48	111	104	98
H-BE 24 BS 25-48		10205000	●		111	104	98
H-BE 24 SS 1-24	Stift / male / mâle	10196100		48	111	104	98
H-BE 24 SS 25-48		10204100			111	104	98
H-BE 24 BS 1-24	Buchse / female / femelle	10197100		48	111	104	98
H-BE 24 BS 25-48		10205100			111	104	98

Gehäuse / Housings / Boîtiers:
3.2: H-B 48

Ansicht anschlussseitig
View from cable side
Vue côté raccordement



3.2 EPIC® D A - V I N C I H - B

Gehäuse / Hood / Capot

Technische Daten:

Vorschriften: DIN 43652

Schutzart: IP 65

Werkstoff: H-B 6 – 48: Aluminiumlegierung, pulverbeschichtet

Technical Data

Specifications: DIN 43652

Protection class: IP 65

Material: H-B 6 – 48: aluminium alloy, powder coated

Caractéristiques techniques

Règlements: DIN 43652

Degré de protection: IP 65

Matière: H-B 6 – 48: Alliage aluminium, recouvert par pulvérisation

3.2 EPIC® D A - V I N C I H - B

Gehäuse / Hood / Capot



PG / M

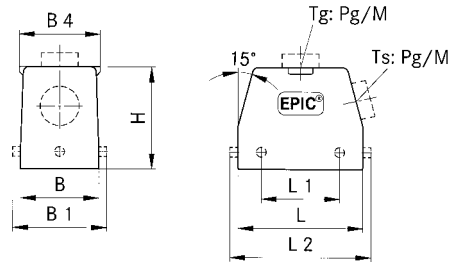

EPIC® H-B Gehäuse: Tüllengehäuse (Kabeleingang seitlich, Bolzen für Längsbügel)

EPIC® H-B housings: hood (side entry, bolts for single locking lever)

Boîtiers EPIC® H-B: capot (sortie latérale, ergots pour simple levier)

H-B 24

Artikel part article	Art.Nr. part No. N° art.	PG	M	ZW	L	L1	L2	L3	L4	B	B1	B2	B3	B4	B5	H	H1	H2	S	d
H-B 24 TS-RO 21	10113900	21		●	120		137			43				45		61				
H-B 24 TS-RO 29	10123900	29		●																
H-B 24 TS-RO M25	19113900		25	●	120		137			43				45		61				
H-B 24 TS-RO M32	19123900		32	●																

Einsätze / Inserts / Inserts: 1.4: H-BE 24 / 1.5: H-EE 46 / 1.7: H-BVE 10 / 1.8: H-D 64 / 1.9: H-DD 108 / 1.10: MC 24
 Kabelverschraubung / Cable gland / Presse-étoupe: 5.1: Metr. / 5.2: PG / 5.3: Kit



PG



M

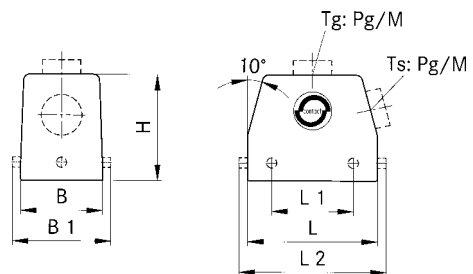

EPIC® H-B Gehäuse: Tüllengehäuse (Kabeleingang seitlich, Bolzen für Längsbügel)

EPIC® H-B housings: hood (side entry, bolts for single locking lever)

Boîtiers EPIC® H-B: capot (sortie latérale, ergots pour simple levier)

H-B 48

Artikel part article	Art.Nr. part No. N° art.	PG	M	ZW	L	L1	L2	L3	L4	B	B1	B2	B3	B4	B5	H	H1	H2	S	d
H-B 48 TS 29	10158000	29		●																
H-B 48 TS 36	10159000	36		●	132		152			90						105				
H-B 48 TS 36	10159200	36																		
H-B 48 TS 42	10160000	42		●																
H-B 48 TS M32	19158000		32																	
H-B 48 TS M40	19159000		40		132		152			90						105				
H-B 48 TS M50	19160000		50																	

Einsätze / Inserts / Inserts: 1.4: H-BE 48 / 1.5: H-EE 92 / 1.7: 2 x H-BVE 10 / 1.8: H-D 128 / 1.9: H-DD 216 / 1.10: 2 x MC 24
 Kabelverschraubung / Cable gland / Presse-étoupe: 5.1: Metr. / 5.2: PG / 5.3: Kit

3.2 EPIC® D A - V I N C I H - B

Anbaugehäuse / Panel mount base / Embase encastrée

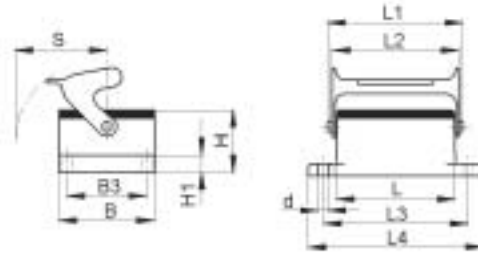

EPIC® H-B Gehäuse: Anbaugehäuse (Längsbügel)
EPIC® H-B housings: panel mount base (single locking lever)
Boîtiers EPIC® H-B: embase encastrée (simple levier)

H-B 6

Artikel part article	Art.Nr. part No. N° art.	PG	L	L1	L2	L3	L4	B	B1	B2	B3	B4	B5	H	H1	H2	S	d
H-B 6 AG-LB	10003000		60	74,8	70	70	80	43			32			27,8	4		44	4,3

Einsätze / Inserts / Inserts: 1.4: H-BE 6 / 1.5: H-EE 10 / 1.9: H-DD 24 / 1.10: MC 6 / 1.11: TB H-BE 6
 Deckel / Cover / Couvercle: 6.1: H-B 6

H-B 10

Artikel part article	Art.Nr. part No. N° art.	PG	L	L1	L2	L3	L4	B	B1	B2	B3	B4	B5	H	H1	H2	S	d
H-B 10 AG-LB	10032900		73	91	88,5	83	93	43			32			27,8	4		50	4,3

Einsätze / Inserts / Inserts: 1.4: H-BE 10 / 1.5: H-EE 18 / 1.7: H-BVE 3 / 1.9: H-DD 42 / 1.10: MC 10 / 1.11: TB H-BE 10

H-B 16

Artikel part article	Art.Nr. part No. N° art.	PG	L	L1	L2	L3	L4	B	B1	B2	B3	B4	B5	H	H1	H2	S	d
H-B 16 AG-LB	10072900		93,3	111	109,5	103	113	43			32			27,8	4		50	4,3

Einsätze / Inserts / Inserts: 1.4: H-BE 16 / 1.5: H-EE 32 / 1.6: H-BS 6 / 1.7: H-BVE 6 / 1.8: H-D 40 / 1.9: H-DD 72 / 1.10: MC 16 / 1.11: TB H-BE 16

H-B 24

Artikel part article	Art.Nr. part No. N° art.	PG	L	L1	L2	L3	L4	B	B1	B2	B3	B4	B5	H	H1	H2	S	d
H-B 24 AG-LB	10102900		120	138	136,5	130	140	43			32			27,8	4		50	4,3

Einsätze / Inserts / Inserts: 1.4: H-BE 24 / 1.5: H-EE 46 / 1.7: H-BVE 10 / 1.8: H-D 64 / 1.9: H-DD 108 / 1.10: MC 24 / 1.11: TB H-BE 24

H-B 48

Artikel part article	Art.Nr. part No. N° art.	PG	L	L1	L2	L3	L4	B	B1	B2	B3	B4	B5	H	H1	H2	S	d
H-B 48 AG-LB	10161000		132	152	139,5	148	165	90			70			39,5	10		105	7

Einsätze / Inserts / Inserts: 1.4: H-BE 48 / 1.5: H-EE 92 / 1.7: 2 x H-BVE 10 / 1.8: H-D 128 / 1.9: H-DD 216 / 1.10: 2 x MC 24 / 1.11: 2 x TB H-BE 24 & 2 x TB H-D 64

5.1 EPIC® CERTOSA M

Kabelverschraubungen metrisch / Cable glands metric thread / Presse-étoupes pas métrique

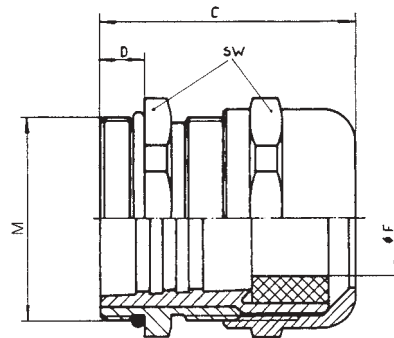

SKINTOP®-ST-M

Artikel part article	Art.Nr. part No. N° art.	M metric thread pas métrique	Kabel Ø cable Ø câble Ø	Farbe colour couleur	SW (mm) opening of the spanner ouverture de clef	C (mm)	D (mm)	VPE packing unit conditionnement
ST-M12	5311 1000	12 x 1,5	3,5-7	grau/grey/grise	15	30	8	100
ST-M16	5311 1010	16 x 1,5	4,5-10	grau/grey/grise	19	34	8	100
ST-M20	5311 1020	20 x 1,5	7-13	grau/grey/grise	25	37	9	100
ST-M25	5311 1030	25 x 1,5	9-17	grau/grey/grise	30	40	10	50
ST-M32	5311 1040	32 x 1,5	11-21	grau/grey/grise	36	47	10	25
ST-M40	5311 1050	40 x 1,5	19-28	grau/grey/grise	46	52	10	10
ST-M50	5311 1060	50 x 1,5	27-35	grau/grey/grise	55	62	12	5

Material / material / matière: Polyamid, RAL 7001 (silbergrau / silver-grey / grise)
 Schutzart / protection class / degré de protection: IP 68 (5 bar)
 Temperaturbereich / temperature range / gamme de température: -20 °C – +80 °C

- [?] Auf Anfrage: RAL 9005 (schwarz), RAL 7035 (lichtgrau)
- [?] On request: RAL 9005 (black), RAL 7035 (light-grey)
- [?] Sur demande: RAL 9005 (noir), RAL 7035 (grise)

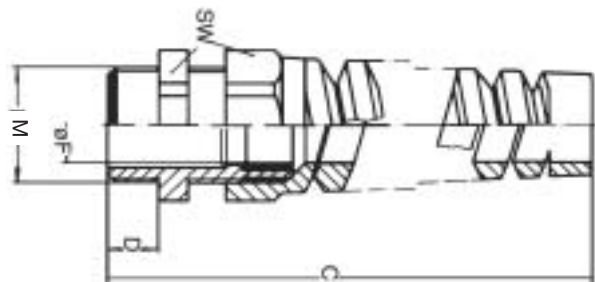

SKINTOP®-BS-M

Artikel part article	Art.Nr. part No. N° art.	M metric thread pas métrique	Kabel Ø cable Ø câble Ø	Farbe colour couleur	SW (mm) opening of the spanner ouverture de clef	C (mm)	D (mm)	VPE packing unit conditionnement
BS-M12	5311 1600	M 12 x 1,5	3,5-7	grau/grey/grise	15	64	8	100
BS-M16	5311 1610	M 16 x 1,5	4,5-10	grau/grey/grise	19	86	8	100
BS-M20	5311 1620	M 20 x 1,5	7-13	grau/grey/grise	25	101	8	50
BS-M25	5311 1630	M 25 x 1,5	9-17	grau/grey/grise	30	125	9	25
BS-M32	5311 1640	M 32 x 1,5	11-21	grau/grey/grise	36	149	10	25

Material / material / matière: Polyamid, RAL 7001 (silbergrau / silver-grey / grise)
 Schutzart / protection class / degré de protection: IP 68 (5 bar)
 Temperaturbereich / temperature range / gamme de température: -20 °C – +80 °C

- [?] Auf Anfrage: RAL 9005 (schwarz), RAL 7035 (lichtgrau)
- [?] On request: RAL 9005 (black), RAL 7035 (light-grey)
- [?] Sur demande: RAL 9005 (noir), RAL 7035 (grise)